



C'è una crepa in ogni cosa ed è da lì che entra la luce.
Nella giusta luce, al momento giusto, tutto è straordinario.

*There is a crack in everything, that's how the light gets in.
In the right light, at the right time, everything is extraordinary.*

INDEX

LANTERNS

Muse Lantern	Pag 8
Cube	Pag 14

COLOURS

Calypto	Pag 20
Sator	Pag 28

SIGNATURE

Mikado	Pag 34
Uffizi	Pag 46
Stardust	Pag 52
Timeless	Pag 56
Vegas	Pag 62
Eclisse	Pag 66
Kubric	Pag 70
Crystal	Pag 76

METROPOLITAN

Dorian	Pag 82
Cinq	Pag 90
Clessidra	Pag 98
Belle	Pag 102
Agata	Pag 108
Messalina	Pag 114
Cornelia	Pag 118
Treasure	Pag 122
Bach	Pag 130
Gea	Pag 134
Manilla	Pag 138
XXL	Pag 142
Ongo Connect	Pag 148

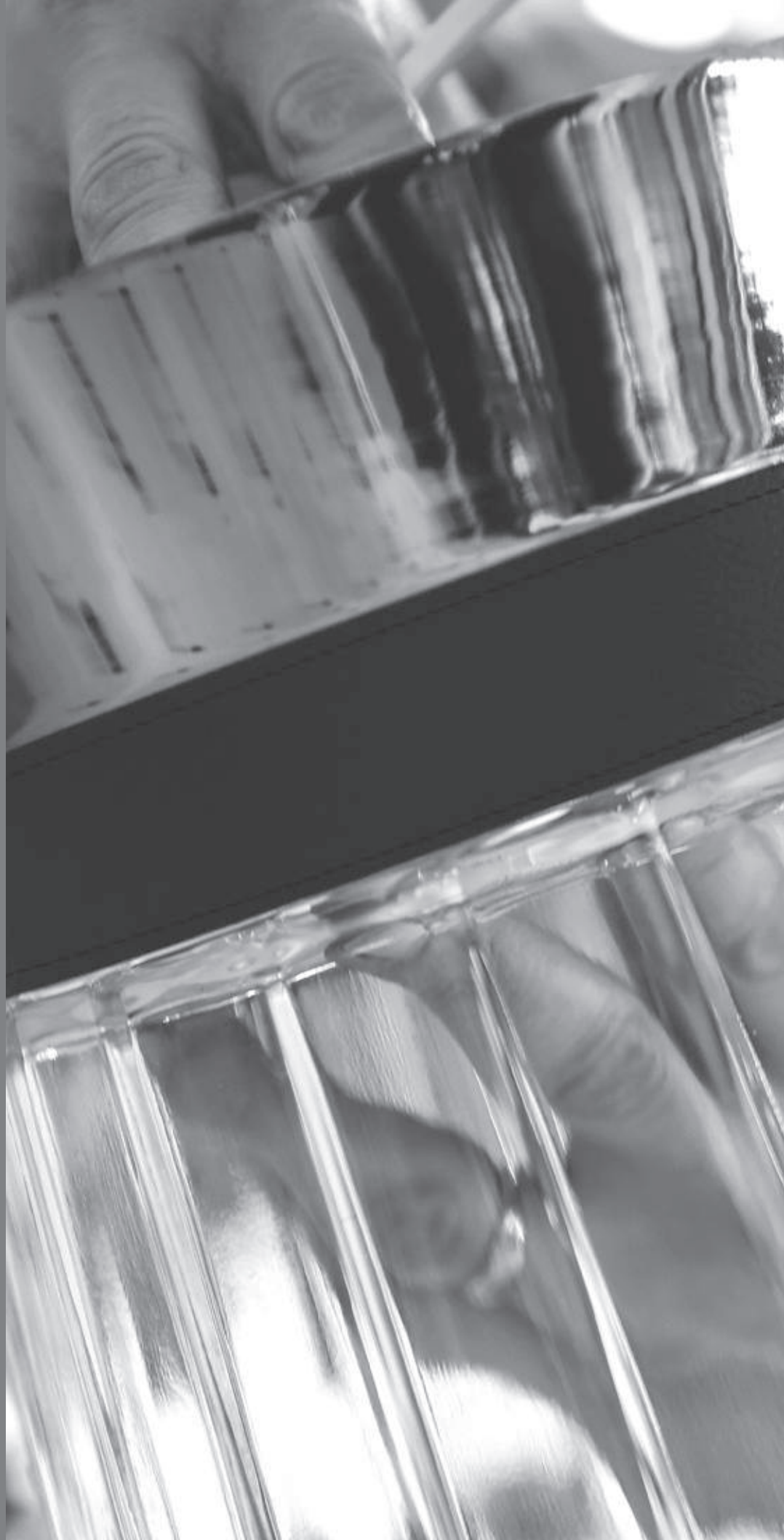



CLASSICS

Audrey	Pag 154
Frame	Pag 160
Cloche	Pag 164
M.me Butterfly	Pag 168
Oops	Pag 172
Coco	Pag 176
Quadra	Pag 186
Rettangola	Pag 196
Kira	Pag 200
Athena	Pag 204
Couture	Pag 208
Divina	Pag 212
Lala	Pag 222
Circus	Pag 226

TASK & READING

Beam	Pag 234
Up	Pag 238
Flexiled	Pag 244
Manhattan	Pag 248
Duos	Pag 252
Tata	Pag 256
Belle Ap Mini	Pag 260

ARCHI-DECORATIVE

Solitario	Pag 264
Recessed	Pag 274
Circus LED	Pag 278

OUTDOOR

Calypso	Pag 282
Muse Lantern	Pag 286
Muse	Pag 290
Freedom	Pag 296
Coco Mega	Pag 300
XXL	Pag 304

ONGO

Ongo	Pag 310
------	---------

CONTRACT DIVISION

Contract Division	Pag 314
-------------------	---------



TAVOLO

TABLE



AGATA
Pag. 108



ATHENA
Pag. 204



AUDREY
Pag. 154/156



BEAM
Pag. 234



CINQ
Pag. 90/93



CLESSIDRA
Pag. 98



CLOCHE
Pag. 164



COCO
Pag. 176/179



CORNELIA
Pag. 118



QUADRA
Pag. 188/187



RETTANGOLA
Pag. 196/197



TREASURE
Pag. 122/123



UFFIZI
Pag. 46



UP
Pag. 238/240



TERRA

FLOOR



AGATA
Pag. 109



AUDREY
Pag. 155



BEAM
Pag. 236



CINQ
Pag. 92/93



CLOCHE
Pag. 165



CORNELIA
Pag. 119



COUTURE
Pag. 203/209



CUBE
Pag. 14



QUADRA
Pag. 188/189



RETTANGOLA
Pag. 198



TATA
Pag. 257



UP
Pag. 239



XXL
Pag. 143



SOSPENSIONE

SUSPENSION



AUDREY
Pag. 157



BELLE
Pag. 102

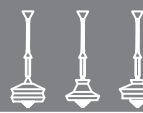

CALYPSO
Pag. 20



CINQ
Pag. 92/94/95



CIRCUS
Pag. 228/278



CORNELIA
Pag. 120



DMINA
Pag. 216/217



SOLTARIO
Pag. 264



STARDUST
Pag. 52/53



TIMELESS
Pag. 56/57/58

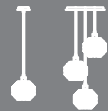

TREASURE
Pag. 124/126



VEGAS
Pag. 62



XXL
Pag. 142



PARETE

WALL



BACH
Pag. 130/131



BELLE
Pag. 104/105/260



COCO
Pag. 177/178/180/181/182



DMINA
Pag. 218



DORIAN
Pag. 84



DUOS
Pag. 252



FLEXLED
Pag. 244



TATA
Pag. 256



TIMELESS
Pag. 59



UFFIZI
Pag. 47



UP
Pag. 241



SOFFITTO

CEILING



CIRCUS
Pag. 226/278



DORIAN
Pag. 83



RECESSED
Pag. 274/275



SOLTARIO
Pag. 268



SATOR
Pag. 28



ESTERNO

OUTDOOR



CALYPSO
Pag. 282



COCO MEGA
Pag. 300



FREEDOM
Pag. 286

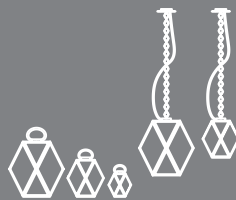

MUSE LANTERN
Pag. 286



MUSE
Pag. 290



COUTURE
Pag. 210



CRYSTAL
Pag. 76



DMINA
Pag. 212



FRAME
Pag. 162



KIRA
Pag. 201



MANILLA
Pag. 138



MESSALINA
Pag. 116



MIKADO
Pag. 38/40



MUSE LANTERN
Pag. 8/9



ONGO
Pag. 148/310

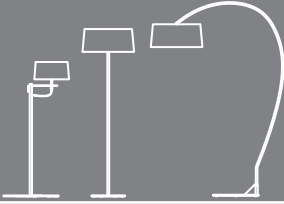

DMINA
Pag. 213/214/215



DORIAN
Pag. 82



FLEXILED
Pag. 248



FRAME
Pag. 160/161



MIME BUTTERFLY
Pag. 168



MIKADO
Pag. 39

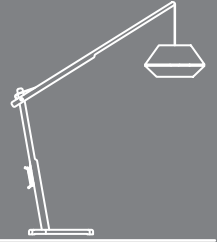

OOPS
Pag. 172



DORIAN
Pag. 86/87



ECLISSE
Pag. 86



KUBRIC
Pag. 71/72/73



MESSALINA
Pag. 115

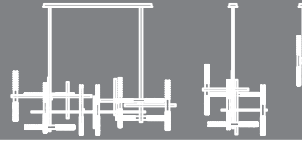

MIKADO
Pag. 34/35/36



GEA
Pag. 134/135



KIRA
Pag. 200



LALA
Pag. 222/223



MANHATTAN
Pag. 248



MESSALINA
Pag. 114



MIKADO
Pag. 41/42



QUADRA
Pag. 190/191/192/193



SATOR
Pag. 28



SOLITARIO
Pag. 270/271



XXL
Pag. 304



LANTERNS

MUSE LANTERN
CUBE

MUSE LANTERN

Design by TRISTAN AUER



Muse Lantern (Medium)



Muse Lantern (Small & Large)



Muse Lantern So (Large)





Vedi Muse Lantern Outdoor
nella sezione dedicata **"OUTDOOR"** a pag 286

*See more of Muse Lantern Outdoor
in the **"OUTDOOR"** section on page 286*

MUSE LANTERN

INDOOR

informazioni tecniche / technical info

Maniglia in seta intrecciata color miele /
Braided silk handle, dark honey colour



Bronzo spazzolato /
Satin bronze

Acrilico color ambra /
Amber acrylic

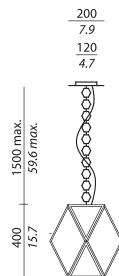

SO MEDIUM

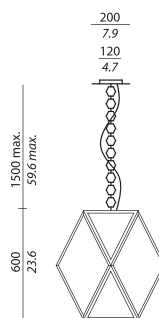

SO LARGE

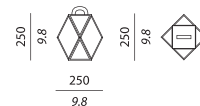

TA SMALL

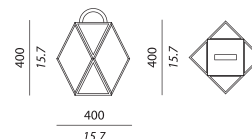

TA MEDIUM

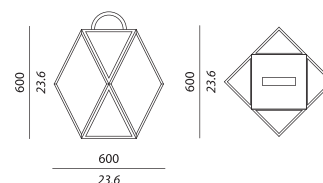

TA LARGE

Finiture / Finishes

■ Struttura bronzo spazzolato.
Diffusore acrilico color ambra.

■ *Satin bronze frame.*
Amber acrylic diffuser.

Cavo in tessuto nero con interruttore On-Off /
Black fabric cable with On-Off switch

L: 300 + 2000 mm
11.8 + 78.7 inches

Fonte luminosa / Light source

CE _____

TA:
1 x E27 classic deco
small: 1 x 40 W
medium: 1 x 60 W
large: 1 x 60 W

SO:
1 x E27 classic deco
medium: 1 x 60 W
large: 1 x 60 W

Idoneo all'uso di lampadine LED e
fluorescenti compatte /

*Suitable for LED or compact fluorescent
bulbs (CFL)*

CE

USA _____

TA:
1 x E26 classic deco
small: 1 x 40 W
medium: 1 x 60 W
large: 1 x 60 W

SO:
1 x E26 classic deco
medium: 1 x 60 W
large: 1 x 60 W

*Suitable for LED or compact
fluorescent bulbs (CFL)*

ETL
Intertek

CUBE

Design by MASSIMILIANO RAGGI



Cube (Small & Large)





CUBE

informazioni tecniche / technical info

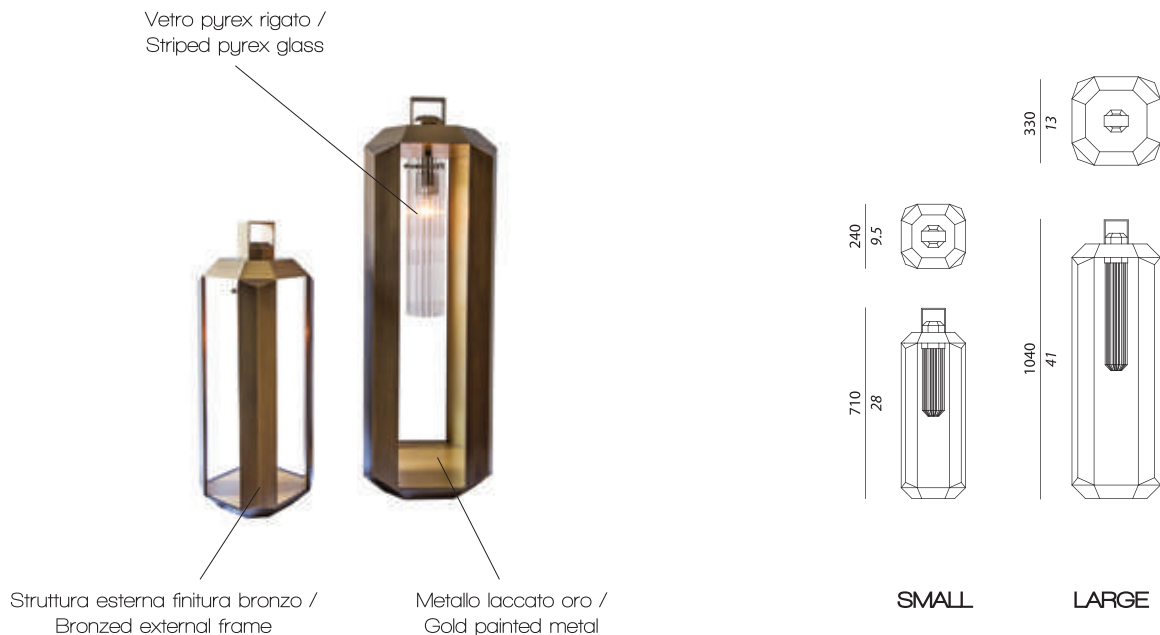

Finiture / Finishes



Struttura esterna finitura bronzo.
Struttura interna in metallo laccato oro.
Diffusore in vetro pyrex rigato.
*Bronzed external frame.
Gold painted metal internal lining.
Striped pyrex glass diffuser.*

SMALL:

Cavo in tessuto nero con interruttore On-Off /
Black fabric cable with On-Off switch

L: 300 + 2000 mm
11.8 + 78.7 inches

LARGE:

Cavo in tessuto nero con interruttore On-Off /
Black fabric cable with On-Off switch

L: 450 + 2000 mm
17.7 + 78.7 inches

Fonte luminosa / Light source

CE

SMALL:

1 x E27 Halogen Energy Saving
70 W

LARGE:

1 x E27 Halogen Energy Saving
70 W

Idoneo all'uso di lampadine
LED e fluorescenti compatte /

*Suitable for LED or compact
fluorescent bulbs (CFL)*

CE

USA

SMALL:

1 x E26 Halogen Energy Saving
70 W

LARGE:

1 x E26 Halogen Energy Saving
70 W

*Suitable for LED or compact
fluorescent bulbs (CFL)*



COLOURS

CALYPSO
SATOR

CALYPSO

Design by SERVOMUTO



Calypso Martinique & Guadeloupe



Calypso







Calypso Antigua



Vedi Calypso Outdoor
nella sezione dedicata **"OUTDOOR"** a pag 282

*See more of Calypso Outdoor
in the **"OUTDOOR"** section on page 282*

CALYPSO

informazioni tecniche / technical info

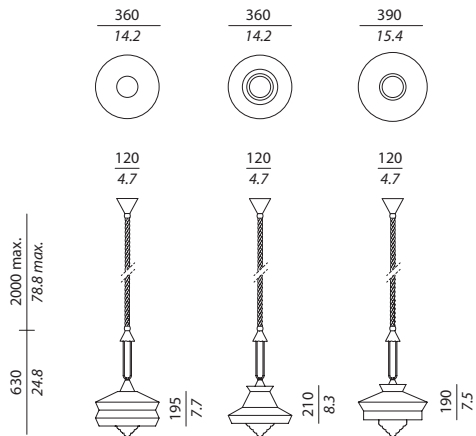

Finiture / Finishes

Struttura ottone spazzolato.
Diffusore in vetro trasparente.

Satin brass body.
Transparent glass diffuser.

Corda in seta intrecciata color verde muschio /
Moss green braided silk cord

L: max 2000 mm
max 78.7 inch



ANTIGUA



MARTINIQUE

Paralumi / Shades

ANTIGUA:	MARTINIQUE:	GUADALOUPE:
Black	Black	Black
Mint	Yellow	Mint
Sale e Pepe	Building	Sale e Pepe
White	White	White

Fonte luminosa / Light source

CE

1 x E27 Compact fluorescent 23 W

*Idoneo all'uso di lampadine LED /
Suitable for LED*



USA

1 x E26 Compact fluorescent bulb 23 W

Suitable for LED or Halogen Energy Saving (max 70 W)



GUADALOUPE



Rosone /
Rosette

SATOR

Design by MASSIMILIANO RAGGI







Sator

SATOR

COLLECTION 1

informazioni tecniche / technical info

100% seta /
100% silk fabrics

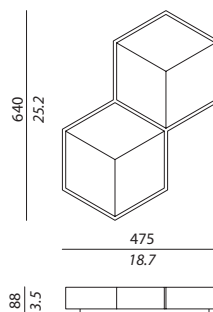
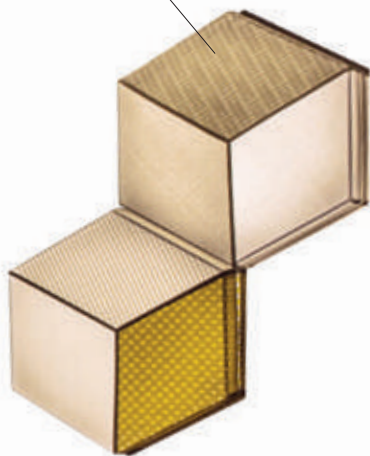

DOUBLE

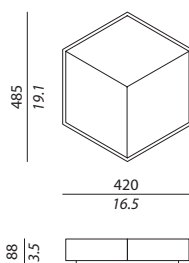

MEDIUM

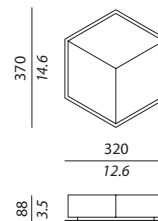

SMALL

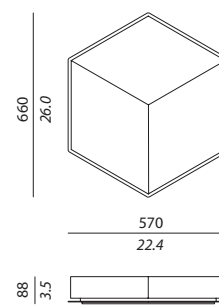

LARGE

Finiture / Finishes

AP SMALL, AP MEDIUM, AP LARGE:
Struttura laccata bianco opaco.

Diffusore 100% seta:

- Giallo senape
- Verde oliva
- Grigio perla

Matt white lacquered body.

100% silk fabrics shade:

- Mustard yellow
- Olive green
- Pearl grey

AP DOUBLE:

Struttura laccata bianco opaco.

Diffusore 100% seta.

Matt white lacquered body.

100% silk fabrics shade:

Giallo senape + Grigio perla
Mustard yellow + Pearl grey

Verde oliva + Grigio perla
Olive green + Pearl grey

Per le combinazioni tessuti vedere apposita tabella
sul sito / Check color chart on website for fabrics
combinations.

Fonte luminosa / Light source

CE

AP SMALL:

1 x Custom LED Board 17 W
2480 Lm , 3000 K , CRI: 90

AP MEDIUM:

1 x Custom LED Board 30 W
4300 Lm , 3000 K , CRI: 90

AP LARGE:

1 x Custom LED Board 55 W
7000 Lm , 3000 K , CRI: 90

AP DOUBLE:

2 x Custom LED Boards 17 W
4960 Lm , 3000 K , CRI: 90

Dimmerabile / Dimmable

Compatibili con sistemi di
controllo remoto. (Consultare il sito).

*Compatible with digital control systems.
(Check on website for more info).*



USA

AP SMALL:

1 x Custom LED Board 17 W
2480 Lm , 3000 K , CRI: 90

AP MEDIUM:

1 x Custom LED Board 30 W
4300 Lm , 3000 K , CRI: 90

AP LARGE:

1 x Custom LED Board 55 W
7000 Lm , 3000 K , CRI: 90

AP DOUBLE:

2 x Custom LED Boards 17 W
4960 Lm , 3000 K , CRI: 90

Dimmable

*Compatible with digital control
systems. (Check on website
for more info).*



SIGNATURE

MIKADO

UFFIZI

STARDUST

TIMELESS

VEGAS

ECLISSE

KUBRIC

CRYSTAL

MIKADO

Design by MASSIMILIANO RAGGI



Mikado So



Mikado So Solo





Mikado So Double



Mikado Ta



Mikado FI



Mikado Ta Solo



Mikado Ap Solo



Mikado Ap

MIKADO

informazioni tecniche / technical info

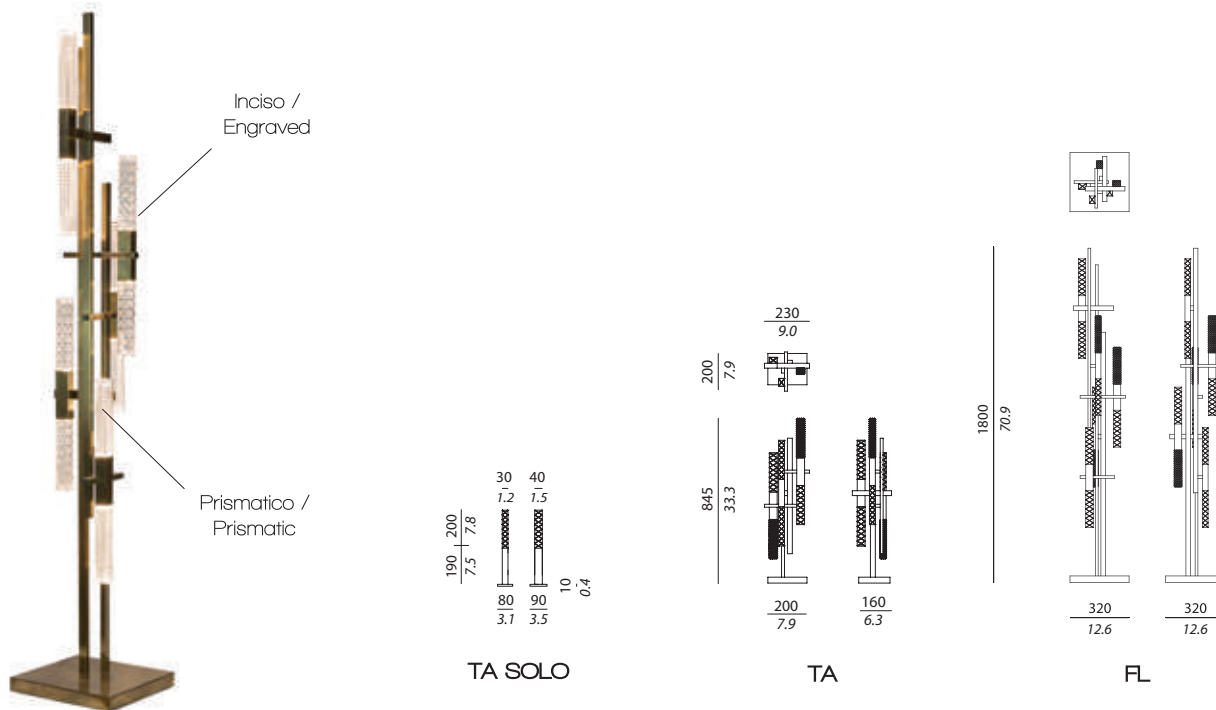

Finiture / Finishes



Struttura in ottone vintage.
Diffusori in cristallo trasparente (Inciso / Prismatico).

*Vintage brass body.
Clear crystal diffusers (Engraved / Prismatic).*

TA SOLO - TA:

Cavo in tessuto nero con interruttore dimmerabile /
Black fabric cable with dimmer switch

L: 300 + 2000 mm
11.8 + 78.7 inches

FL:

Cavo in tessuto nero con interruttore dimmerabile /
Black fabric cable with dimmer switch

L: 450 + 2000 mm
17.7 + 78.7 inches

Fonte luminosa / Light source

CE _____

TA SOLO:
1 x custom LED 4 W
(tot. 560 Lm)
3000 K , CRI: 90

TA:
6 x custom LED 4 W
(tot. 3360 Lm)
3000 K , CRI: 90

FL:
10 x custom LED 4 W
(tot. 5600 Lm)
3000 K , CRI: 90

Dimmerabile / Dimmable

Compatibili con sistemi di controllo remoto. (Consultare il sito).

Compatible with digital control systems. (Check on website for more info).

CE

USA _____

TA SOLO:
1 x custom LED 4 W
(tot. 560 Lm)
3000 K , CRI: 90

TA:
6 x custom LED 4 W
(tot. 3360 Lm)
3000 K , CRI: 90

FL:
10 x custom LED 4 W
(tot. 5600 Lm)
3000 K , CRI: 90

Dimmable

Compatible with digital control systems. (Check on website for more info)

MIKADO

informazioni tecniche / technical info

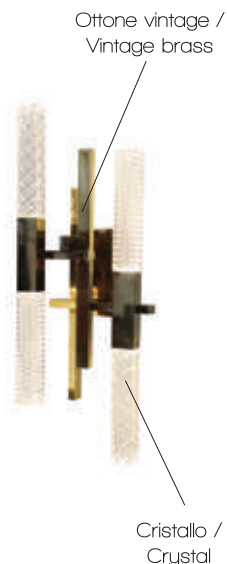

AP

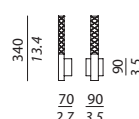

AP SOLO

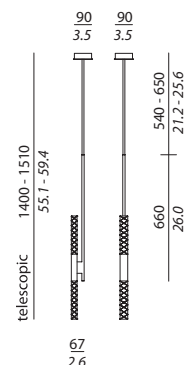

SO SOLO

Finiture / Finishes



Struttura in ottone vintage.
Diffusori in cristallo trasparente (Inciso / Prismatico)

*Vintage brass body.
Clear crystal diffusers (Engraved / Prismatic).*

Fonte luminosa / Light source

CE

AP:
4 x custom LED 4 W
(tot. 2240 Lm)
3000 K , CRI: 90

AP SOLO:
2 x custom LED 4 W
(tot. 1120 Lm)
3000 K , CRI: 90

SO SOLO:
2 x custom LED 4 W
(tot. 1120 Lm)
3000 K , CRI: 90

Dimmerabile / Dimmable

Compatibili con sistemi di controllo remoto. (Consultare il sito).

Compatible with digital control systems. (Check on website for more info).

USA

AP:
4 x custom LED 4 W
(tot. 2240 Lm)
3000 K , CRI: 90

AP SOLO:
2 x custom LED 4 W
(tot. 1120 Lm)
3000 K , CRI: 90

SO SOLO:
2 x custom LED 4 W
(tot. 1120 Lm)
3000 K , CRI: 90

Dimmable

Compatible with digital control systems. (Check on website for more info).



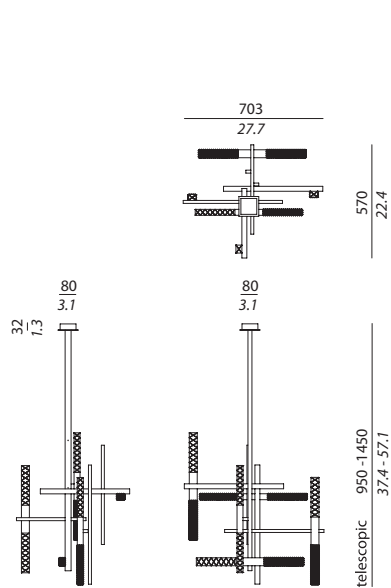

SO

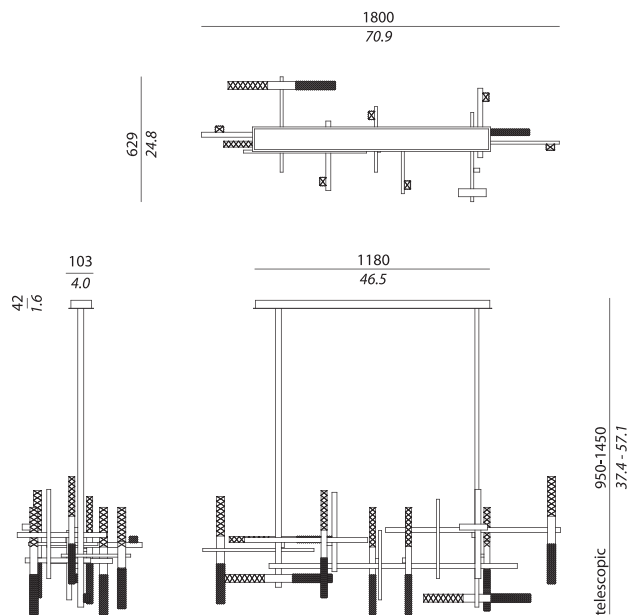

SO DOUBLE

Finiture / Finishes



Struttura in ottone vintage.
Diffusori in cristallo trasparente (Inciso / Prismatico).

*Vintage brass body.
Clear crystal diffusers (Engraved / Prismatic).*

Fonte luminosa / Light source

CE

SO:
10 x custom LED 4 W
(tot. 5600 Lm)
3000 K , CRI: 90

SO DOUBLE:
20 x custom LED 4 W
(tot. 11200 Lm)
3000 K , CRI: 90

Dimmerabili / Dimmable

Compatibili con sistemi di controllo remoto. (Consultare il sito).

Compatible with digital control systems. (Check on website for more info).

USA

SO:
10 x custom LED 4 W
(tot. 5600 Lm)
3000 K , CRI: 90

SO DOUBLE:
20 x custom LED 4 W
(tot. 11200 Lm)
3000 K , CRI: 90

Dimmable

Compatible with digital control systems. (Check on website for more info).

UFFIZI

Design by MASSIMILIANO RAGGI



Uffizi Ta



Uffizi Ap Trio, Ap 1, Ap 2, Ap 3





Uffizi Ap Trio, Ap 1, Ap 2, Ap 3

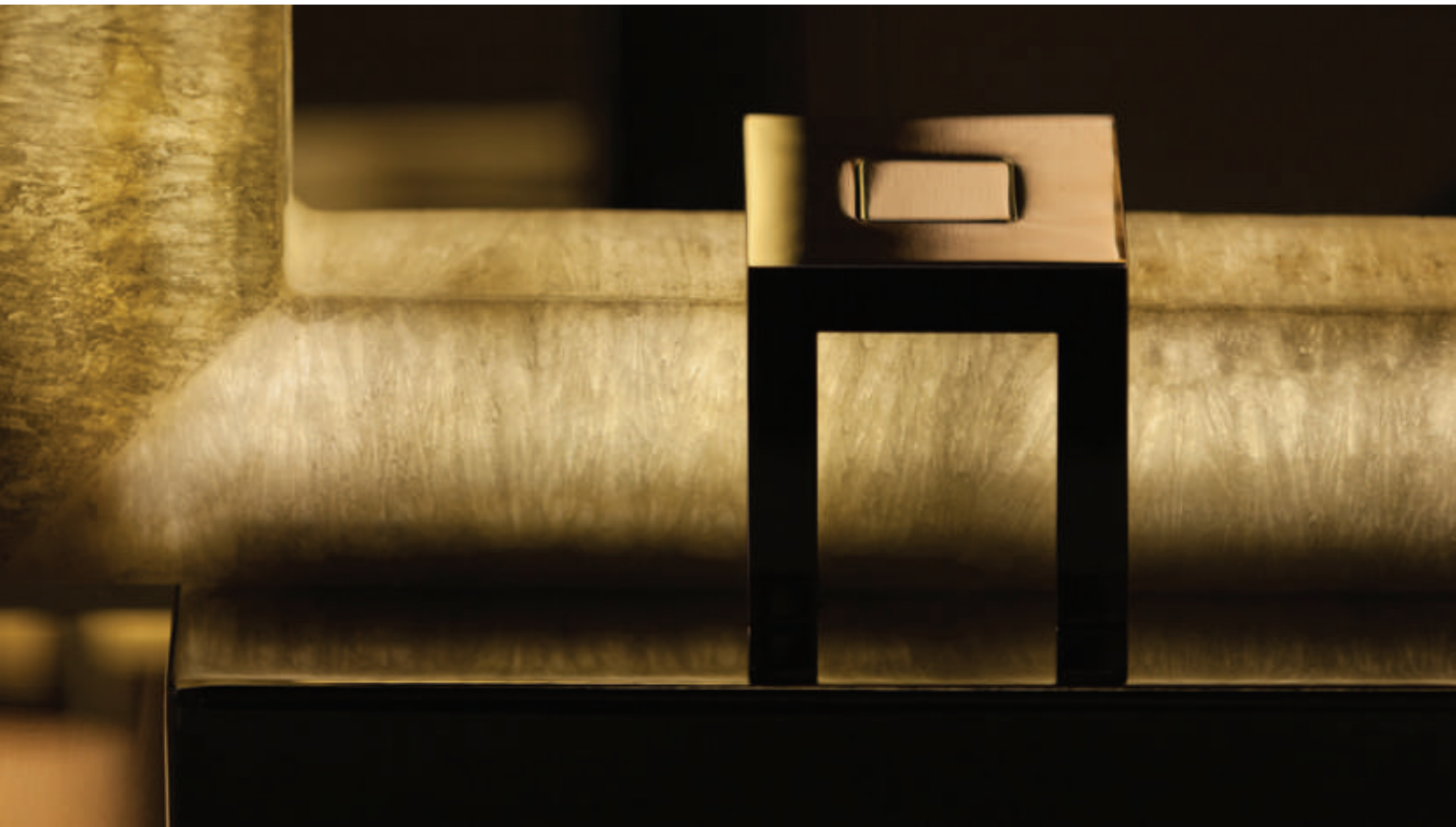

Cornice in marmo onice ambra /
Amber onyx marble frame



Interruttore dimmerabile touch sulla base /
Touch dimmer switch on the base

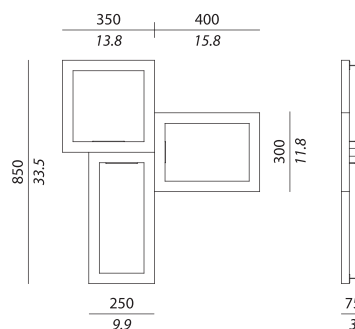

AP TRIO

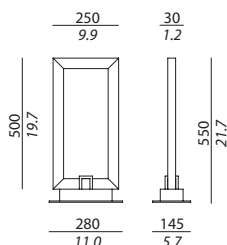

TA

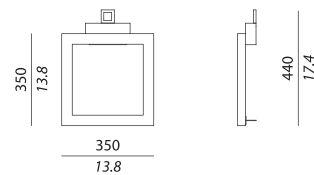

AP 1

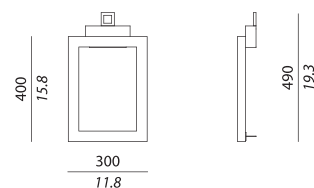

AP 2

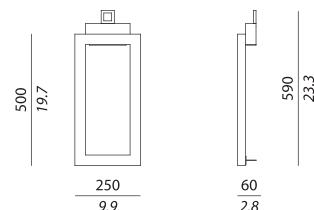

AP 3

Finiture / Finishes

AP TRIO, AP 1, 2, 3



Attacco a parete nickel lucido.
Cornice in marmo onice ambra.



Polished nickel wall bracket.
Amber onyx marble frame.

TA



Base nickel lucido.
Cornice in marmo onice ambra.



Polished nickel body.
Amber onyx marble frame.

TA:

Cavo in tessuto nero /
Black fabric cable

L: 300 + 2000 mm
11.8 + 78.7 inches

Fonte luminosa / Light source

CE _____

AP TRIO:
3 x Custom strip LED 25 W
(tot. 6300 Lm) - 2700 K , CRI: 90

AP 1, 2, 3:
1 x Custom strip LED 25 W
(tot. 2100 Lm) - 2700 K , CRI: 90

TA:
1 x Custom Strip LED 25 W
(tot. 2100 Lm) - 2700 K , CRI: 90

Dimmerabile / Dimmable

Compatibili con sistemi di
controllo remoto.
(Verifica sul sito).

Compatible with digital
control systems.
(Check on website for more info).



USA _____

AP TRIO:
3 x Custom strip LED 25 W
(tot. 6300 Lm)
2700 K , CRI: 90

AP 1, 2, 3:
1 x Custom strip LED 25 W
(tot. 2100 Lm)
2700 K , CRI: 90

TA:
1 x Custom strip LED 25 W
(tot. 2100 Lm)
2700 K , CRI: 90

Dimmable

Compatible with digital control
systems. (Check on website
for more info).



STARDUST

Design by MAURIZIO DI MAURO - MARCELLO COLLI



Stardust So Small



Stardust So Large



Stardust So Large

STARDUST

informazioni tecniche / technical info

Bronzo spazzolato chiaro opaco o nickel nero lucido /
Matt light satin bronze or polished black nickel



Vetro bianco satinato /
Satin white glass

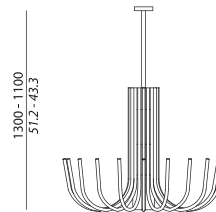
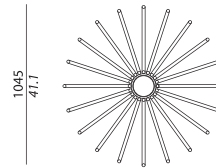

LARGE

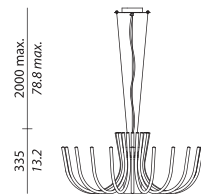
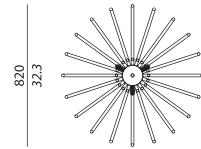

SMALL

Finiture / Finishes

 Struttura bronzo spazzolato chiaro opaco.
Diffusore in vetro bianco satinato.

 *Matt light satin bronze body.*
Satin white glass diffuser.

 Struttura nickel nero lucido.
Diffusore in vetro bianco satinato.

 *Polished black nickel body.*
Satin white glass diffuser.

**Due fonti luminose indipendenti,
doppia accensione /
Two independent light sources,
double switch**

Fonte luminosa / Light source

CE _____

SMALL:
1 x E27 Halogen Energy Saving
max 105 W
+
20 x custom LED 3 W
(tot. 2000 Lm)

LARGE:
1 x E27 Halogen Energy Saving
max 105 W
+
20 x custom LED 3 W
(tot. 2000 Lm)

Idoneo all'uso di lampadine
LED e fluorescenti compatte /
Suitable for LED or compact
fluorescent bulbs (CFL)

CE

USA _____

SMALL:
1 x E26 Halogen Energy Saving
max 105 W
+
20 x custom LED 3 W
(tot. 2000 Lm)

LARGE:
1 x E26 Halogen Energy Saving
max 105 W
+
20 x custom LED 3 W
(tot. 2000 Lm)

Suitable for LED or compact
fluorescent bulbs (CFL)

 **ETL**
Intertek

TIMELESS

Design by STAFFAN TOLLGARD



Timeless So Large



Timeless So (Large & Small)



Timeless So (Large & Small)



Nella foto illuminazione indiretta / In the picture indirect light only

Timeless Ap



TIMELESS

informazioni tecniche / technical info

Sistema di accensione dimmerabile progressiva /
Sequential dimming system



Spenta /
Off

Illuminazione singola /
Single lighting

Doppia illuminazione /
Double lighting

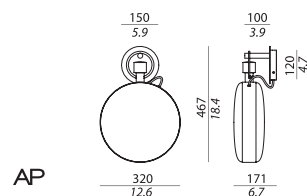

AP

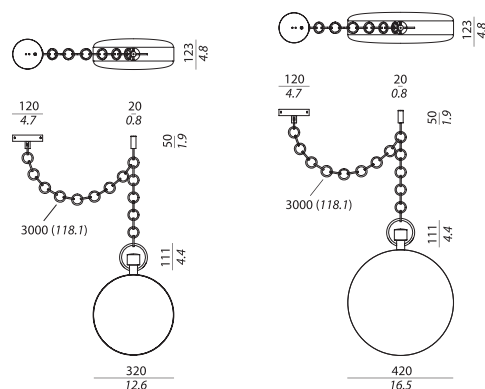

SO SMALL

SO LARGE

Finiture / Finishes

 Struttura nickel nero lucido.
Diffusori in vetro bianco satinato.

 *Polished black nickel body.*
Satin white glass diffusers.

 Struttura bronzo spazzolato chiaro lucido.
Diffusori in vetro bianco satinato.

 *Glossy light satin bronze body.*
Satin white glass diffusers.

Fonte luminosa / Light source

CE _____

SO:
2 x LED Boards
small: 2 x 17 W (tot. 4960 Lm)
3000 K , CRI: 90
large: 2 x 30 W (tot. 8000 Lm)
3000 K , CRI: 90

AP:
2 x LED Boards 17 W
(tot. 4960 Lm)
3000 K , CRI: 90

Sistema di accensione dimmerabile progressiva / Sequential dimming system

Compatibili con sistemi di controllo remoto. (Consultare il sito).

Compatible with digital control systems. (Check on website for more info).

CE

USA _____

SO:
2 x LED Boards
small: 2 x 17 W (tot. 4960 Lm)
3000 K , CRI: 90
large: 2 x 30 W (tot. 8000 Lm)
3000 K , CRI: 90

AP:
2 x LED Boards 17 W
(tot. 4960 Lm)
3000 K , CRI: 90

Sequential dimming system

Compatible with digital control systems. (Check on website for more info).

VEGAS

Design by MASSIMILIANO RAGGI



Vegas So





VEGAS

informazioni tecniche / technical info

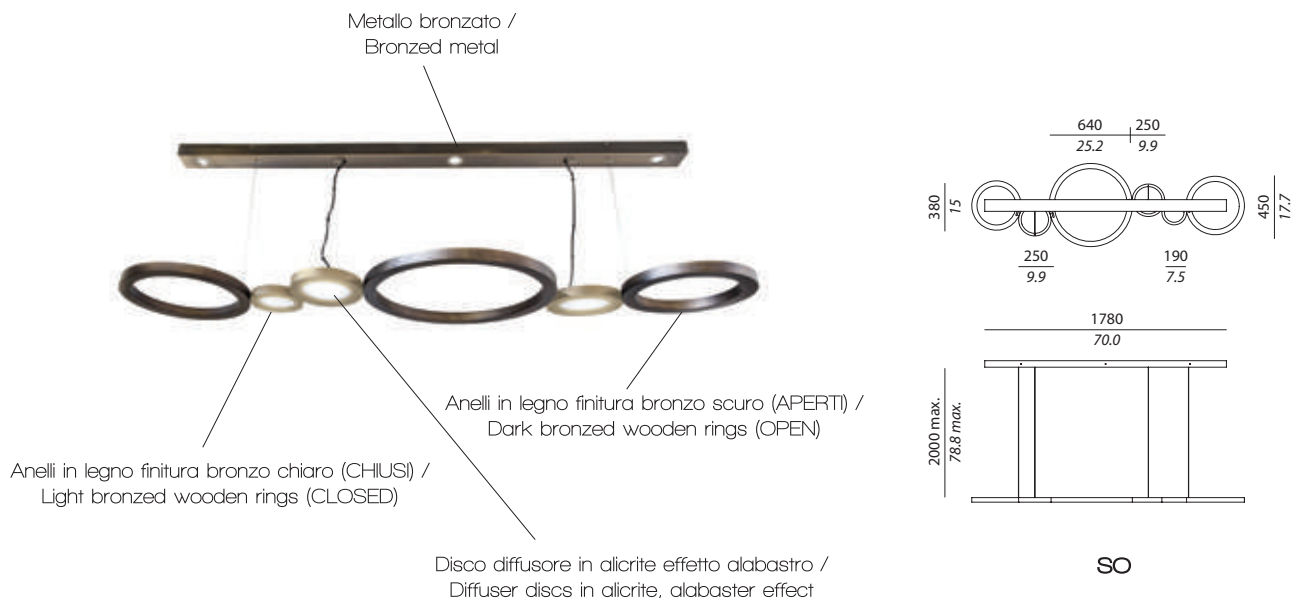

Finiture / Finishes



Rosone in metallo bronzato.
Anelli in legno con finitura bronzo e
bronzo chiaro.
Dischi diffusori in alicrite effetto alabastro.

*Bronzed metal ceiling bar.
Dark and light bronzed wooden rings.
Diffuser discs in alicrite, alabaster effect.*

Cavo in tessuto nero. Cavetti in acciaio /
Black fabric cable. Steel wires

L: 2000 mm
78.7 inches

**Due fonti luminose indipendenti,
doppia accensione /
Two independent light sources,
double switch**

Dimmerazione disponibile solo per i COB Led /
Dimming available for COB Led only

Fonte luminosa / Light source

CE _____

SO:

Rosone / Ceiling bar:
3 x COB LED 12 W
(tot. 5400 Lm)
2700 K , CRI: >90

Anelli / Rings:
2 x Strip LED 12 W +
1 Strip LED 8 W
(tot. 1400 Lm)
2700 K , CRI: >90

Dimmerabile / Dimmable

Compatibili con sistemi
di controllo remoto.
(Consultare il sito).

*Compatible with digital
control systems.
(Check on website for more info).*

CE

USA _____

SO:

Ceiling bar:
3 x COB LED 12 W
(tot. 5400 Lm)
2700 K , CRI: >90

Rings:
2 x Strip LED 12 W +
1 Strip LED 8 W
(tot. 1400 Lm)
2700 K , CRI: >90

Dimmable

*Compatible with digital
control systems.
(Check on website for
more info).*

ETL
Intertek

ECLISSE

Design by MASSIMILIANO RAGGI



Eclisse So





ECLISSE

informazioni tecniche / technical info

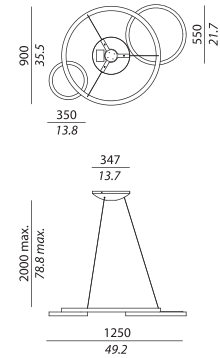

SO

Finiture / Finishes



Rosone in metallo bronzato.
Anelli in legno con finitura bronzo e
bronzo chiaro.
Dischi diffusori in alicrite effetto alabastro.

*Bronzed metal canopy.
Dark and light bronzed wooden rings.
Diffuser discs in alicrite, alabaster effect.*

Cavo in tessuto nero. Cavetti in acciaio /
Black fabric cable. Steel wires.

L: 2000 mm
78.7 inches

**Due fonti luminose indipendenti,
doppia accensione /
Two independent light sources,
double switch**

Dimmerazione disponibile solo per i COB Led /
Dimming available for COB Led only

Fonte luminosa / Light source

CE _____

SO:

Rosone / Canopy:
1 x COB LED 18 W
(tot. 2400 Lm)
2700 K , CRI: >90

Anelli / Rings:
1 x Strip LED 17 W +
1 x 1 Strip LED 19 W
(tot. 1400 Lm)
2700 K , CRI: >90

Dimmerabile / Dimmable

Compatibili con sistemi
di controllo remoto.
(Consultare il sito).

*Compatible with digital
control systems.
(Check on website for more info).*

CE

USA _____

SO:

Canopy:
1 x COB LED 18 W
(tot. 2400 Lm)
2700 K , CRI: >90

Rings:
1 x Strip LED 17 W +
1 x 1 Strip LED 19 W
(tot. 1400 Lm)
2700 K , CRI: >90

Dimmable

*Compatible with digital
control systems.
(Check on website
for more info).*

ETL
Intertek

KUBRIC

Design by MASSIMILIANO RAGGI



Kubric So Special Cluster



Kubric So Large



Kubric So Cluster of 5



Kubric So Cluster of 10



Composizioni su misura disponibili su progetto,
a richiesta. Contattare l'ufficio commerciale.

*Custom clusters available on demand.
Contact the Sales Department.*

KUBRIC

informazioni tecniche / technical info

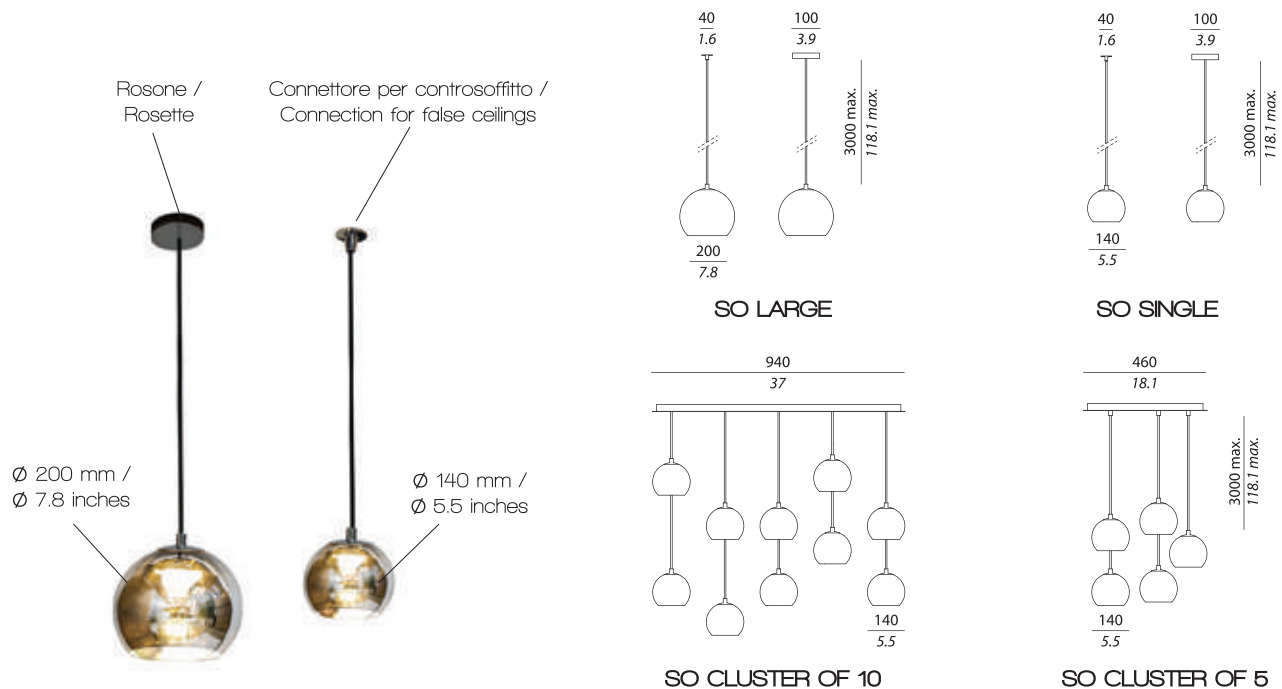

Finiture / Finishes

 Struttura cromo.
Diffusore vetro cromato con interno oro.

 *Chrome body.*
Diffusing chromed glass with gold lining.

 Struttura bronzo spazzolato.
Diffusore vetro bronzato con interno oro.

 *Satin bronze body.*
Diffusing bronzed glass with gold lining.

Cavo in tessuto nero. /
Black fabric cable.

L: 3000 mm
118.1 inches

Fonte luminosa / Light source

CE _____

SO SINGLE - SO LARGE:
1 x custom LED 5 W
550 Lm , 2700 K , CRI: 90

SO CLUSTER OF 5:
5 x custom LED 5 W
2750 Lm , 2700 K , CRI: 90

SO CLUSTER OF 10:
10 x custom LED 5 W
5500 Lm , 2700 K , CRI: 90

Dimmerabile / Dimmable

Compatibili con sistemi di controllo remoto. (Consultare il sito).

Compatible with digital control systems. (Check on website for more info).

CE

USA _____

SO SINGLE - SO LARGE:
1 x custom LED 5 W
550 Lm , 2700 K , CRI: 90

SO CLUSTER OF 5:
5 x custom LED 5 W
2750 Lm , 2700 K , CRI: 90

SO CLUSTER OF 10:
10 x custom LED 5 W
5500 Lm , 2700 K , CRI: 90

Dimmable

Compatible with digital control systems. (Check on website for more info).

 ETL Intertek

CRYSTAL

Design by NIKA ZUPANC

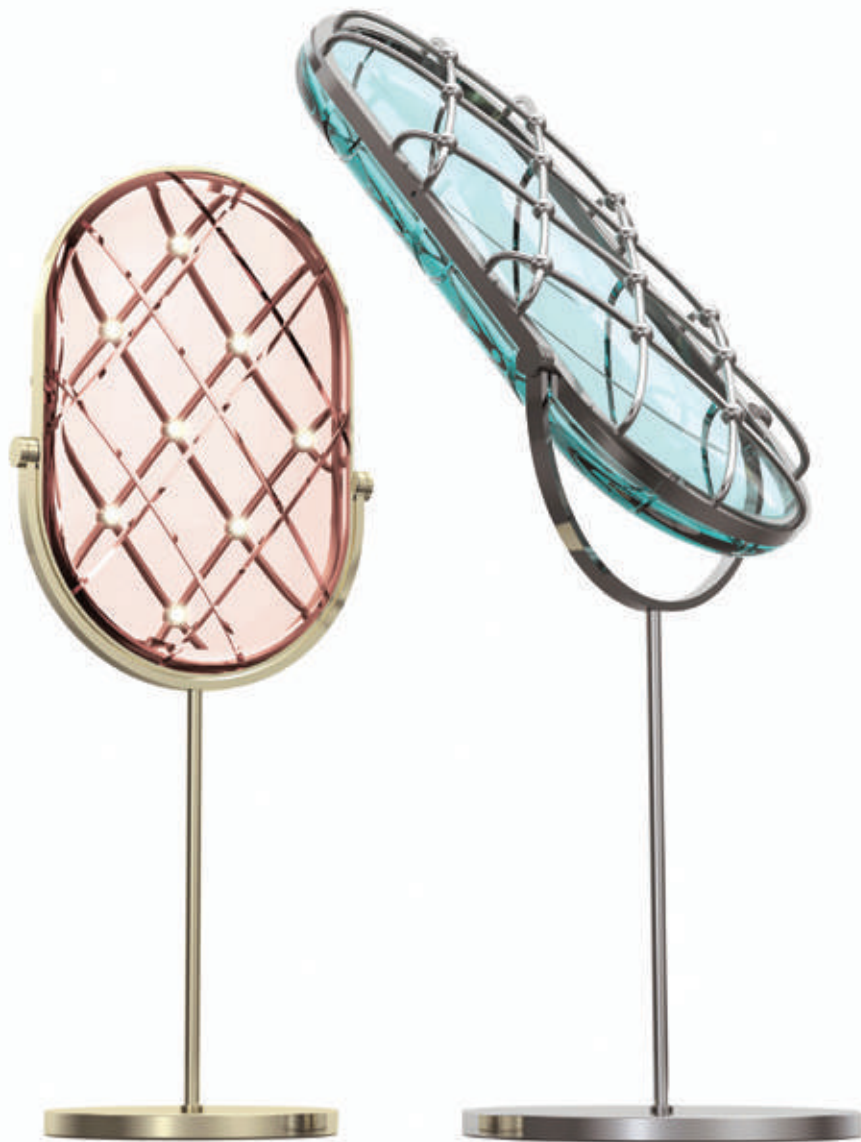

Crystal (Small & Large)



Crystal Small





Crystal Large

CRYSTAL

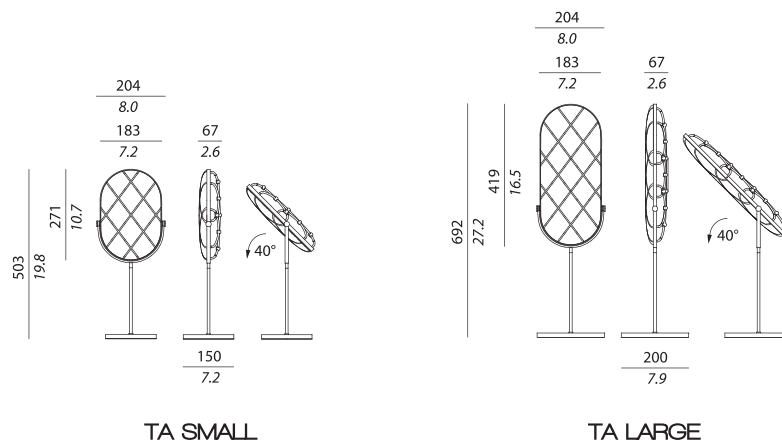
informazioni tecniche / technical info



Finiture / Finishes

-  Struttura nickel lucido
Diffusore in cristallo azzurro.
*Polished nickel body.
Crystal diffuser, light blue colour.*
-  Struttura ottone lucido.
Diffusore in cristallo rosa.
*Polished brass body.
Crystal diffuser, pink colour.*

Cavo in tessuto nero
con interruttore dimmerabile /
Black fabric cable with dimming switch

L: 300 + 2000 mm
11.8 + 78.7 inches

Fonte luminosa / Light source

CE _____

TA SMALL:
9 x Custom LED 3W
(tot. 850 Lm)
3000 K , CRI: >90

TA LARGE:
14 x Custom LED 3W
(tot. 1300 Lm)
3000 K , CRI: >90

Dimmerabile / Dimmable

USA _____

TA SMALL:
9 x Custom LED 3W
(tot. 850 Lm)
3000 K , CRI: >90

TA LARGE:
14 x Custom LED 3W
(tot. 1300 Lm)
3000 K , CRI: >90

Dimmable

CE



METROPOLITAN

DORIAN

CINQ

CLESSIDRA

BELLE

AGATA

MESSALINA

CORNELIA

TREASURE

BACH

GEA

MANILLA

XXL

ONGO CONNECT

DORIAN

Design by MARCELLO COLLI



Dorian Fl



Dorian P1





Dorian Ap



Dorian So (Large)



Dorian So (Small)

DORIAN

informazioni tecniche / technical info

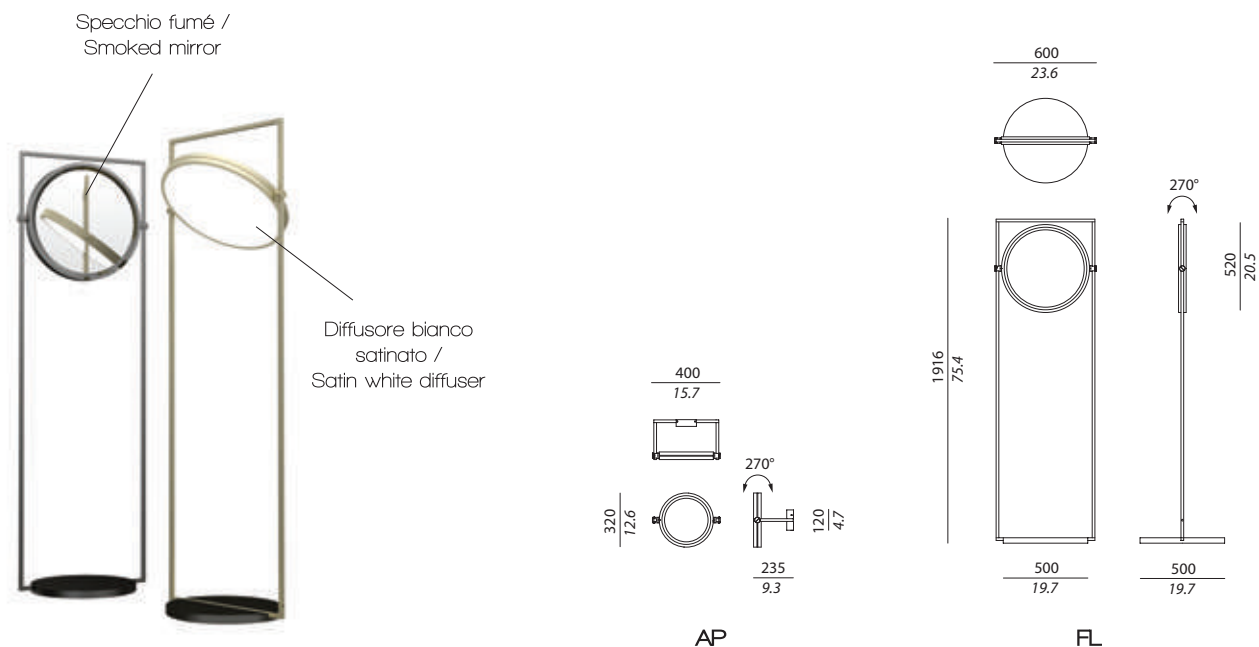

Finiture / Finishes



Struttura nickel nero lucido.
Specchio fumé.
Diffusore bianco satinato.
*Polished black nickel body.
Smoked mirror.
Satin white diffuser.*



Struttura bronzo spazzolato chiaro lucido.
Specchio fumé.
Diffusore bianco satinato.
*Polished light satin bronze body.
Smoked mirror.
Satin white diffuser.*

Interruttore dimmerabile a bordo.
Dimmer switch on board.

Cavo in tessuto nero /
Black fabric cable

L: 450 + 2000 mm
17.7 + 78.9 inches

Fonte luminosa / Light source

CE _____

AP:
1 x Custom LED Board 17 W
(tot. 2480 Lm)
3000 K , CRI: 90

FL:
1 x Custom LED Board 55 W
(tot. 7500 Lm)
3000 K , CRI: 90

Dimmerabile / Dimmable

Compatibili con sistemi
di controllo remoto.
(Consultare il sito).

*Compatible with digital
control systems.
(Check on website for more info).*

CE

USA _____

AP:
1 x Custom LED Board 17 W
(tot. 2480 Lm)
3000 K , CRI: 90

FL:
1 x Custom LED Board 55 W
(tot. 7500 Lm)
3000 K , CRI: 90

Dimmable

*Compatible with digital
control systems.
(Check on website
for more info).*

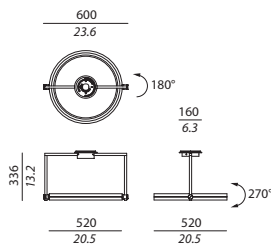

PL

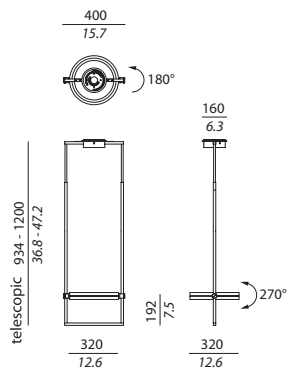

SO SMALL

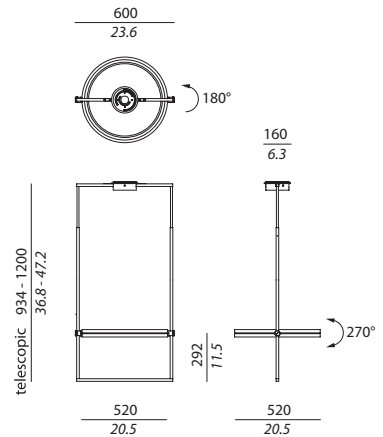

SO LARGE

Finiture / Finishes



Struttura nickel nero lucido.
Specchio fumé.
Diffusore bianco satinato.
*Polished black nickel body.
Smoked mirror.
Satin white diffuser.*



Struttura bronzo spazzolato chiaro lucido.
Specchio fumé.
Diffusore bianco satinato.
*Glossy light satin bronze body.
Smoked mirror.
Satin white diffuser.*

Fonte luminosa / Light source

CE _____

PL:
1 x Custom LED Board 55 W
(tot. 7500 Lm)
3000 K , CRI: 90

SO:
1 x Custom LED Board
small: 17 W (tot. 2480 Lm)
large: 55 W (tot. 7500 Lm)
3000 K , CRI: 90

Dimmerabile / Dimmable

Compatibili con sistemi di controllo remoto.
(Consultare il sito).
*Compatible with digital control systems.
(Check on website for more info).*

USA _____

PL:
1 x Custom LED Board 55 W
(tot. 7500 Lm)
3000 K , CRI: 90

SO:
1 x Custom LED Board
small: 17 W (tot. 2480 Lm)
large: 55 W (tot. 7500 Lm)
3000 K , CRI: 90

Dimmable

*Compatible with digital control systems.
(Check on website for more info).*



CINQ

Design by MASSIMILIANO RAGGI



Cinq Fl & Cinq Ta Large



Cinq Ta Small





Cinq Liseuse





Cinq So Large

CINQ

informazioni tecniche / technical info

Nickel lucido o bronzo spazzolato lucido /
Polished nickel or glossy satin bronze

Cinturino in pelle nera, giallo senape
o arancio "becco d'oca" /
Black, duck beack orange or
mustard yellow leather belt

Vetro plissettato /
Pleated glass

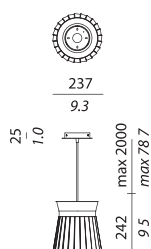

SO SMALL

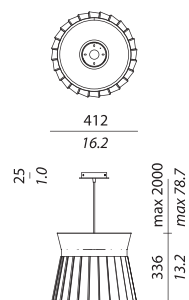

SO LARGE

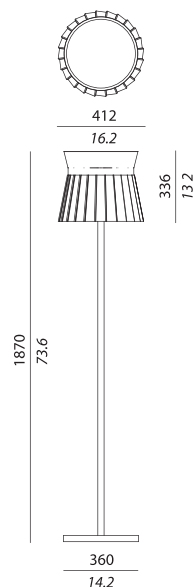

FL LARGE

Finiture / Finishes



Struttura nickel lucido.
Cinturino in pelle nera o giallo senape.
Vetro plissettato metallizzato nickel.



Polished nickel body.
Black or mustard yellow leather belt.
Pleated nickel glass diffuser.



Struttura bronzo spazzolato lucido.
Cinturino in pelle nera o arancio "becco d'oca".
Vetro plissettato metallizzato bronzo.



Glossy satin bronze body.
Black or duck beack orange leather belt.
Pleated bronzed glass diffuser.

FL LARGE;
Cavo in tessuto nero / *Black fabric cable*
L: 450 + 2000 mm
17.7 + 78.9 inches

Fonte luminosa / Light source

CE _____

SO:
1 x Custom LED Board
small: 16 W (tot. 2300 Lm)
large: 16 W (tot. 2300 Lm)
3000 K , CRI: 90

FL LARGE:
1 x Custom LED Board 16 W
(tot. 2300 Lm)
3000 K , CRI: 90

**Sistema di accensione dimmerabile
progressiva (a due fasi) /
Sequential dimming system
(two phases)**

Compatibili con sistemi di controllo
remoto. (Consultare il sito).

*Compatible with digital control
systems. (Check on website for
more info).*

CE

USA _____

SO:
1 x Custom LED Board
small: 16 W (tot. 2300 Lm)
large: 16 W (tot. 2300 Lm)
3000 K , CRI: 90

FL LARGE:
1 x Custom LED Board 16 W
(tot. 2300 Lm)
3000 K , CRI: 90

**Sequential dimming system
(two phases)**

*Compatible with digital control
systems.*

*Check on website for more
info).*

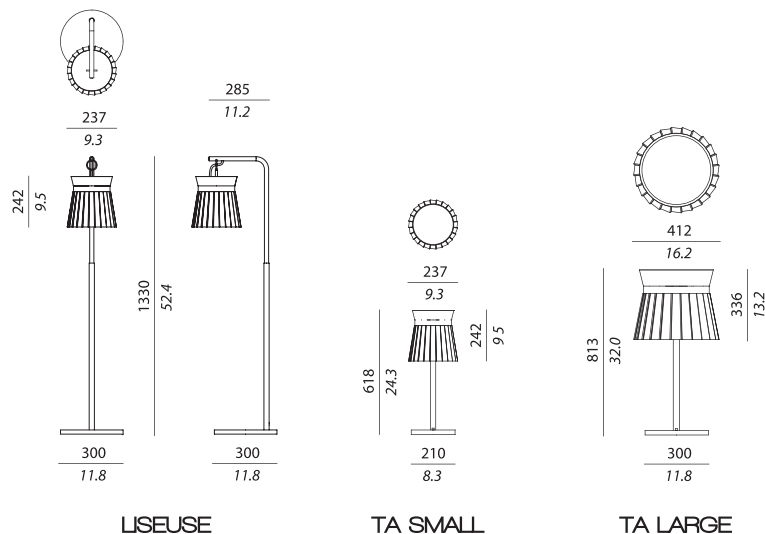

Finiture / Finishes

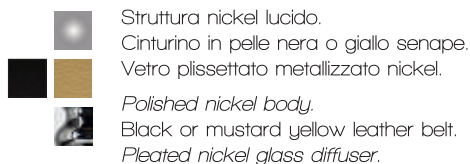

LISEUSE:
Cavo in tessuto nero / *Black fabric cable*
L: 450 + 2000 mm
17.7 + 78.9 inches

TA:
Cavo in tessuto nero / *Black fabric cable*
L: 450 + 2000 mm
17.7 + 78.9 inches

Fonte luminosa / Light source

CE _____

LISEUSE:
1 x Custom LED Board 16 W
(tot. 2300 Lm)
3000 K , CRI: 90

TA:
1 x Custom LED Board
small: 16 W (tot. 2300 Lm)
large: 16 W (tot. 2300 Lm)
3000 K , CRI: 90

**Sistema di accensione dimmerabile
progressiva (a due fasi) /
Sequential dimming system
(two phases)**

Compatibili con sistemi di controllo
remoto. (Consultare il sito).

*Compatible with digital control
systems. (Check on website for
more info).*



USA _____

LISEUSE:
1 x Custom LED Board 16 W
(tot. 2300 Lm)
3000 K , CRI: 90

TA:
1 x Custom LED Board
small: 16 W (tot. 2300 Lm)
large: 16 W (tot. 2300 Lm)
3000 K , CRI: 90

**Sequential dimming system
(two phases)**

*Compatible with digital
control systems.
(Check on website for more
info).*

CLESSIDRA

Design by MASSIMILIANO RAGGI



Clessidra Ta (Kayros / Kronos)





CLESSIDRA

informazioni tecniche / technical info



Finiture / Finishes



Struttura cromo.
Vetro soffiato: metallizzato cromo superiore e metallizzato nero inferiore.
Diffusore bianco lucido.

*Chrome frame.
Hand blown glass: polished chrome upper glass and diffusing black lower glass.
Top diffuser polished white.*



Struttura bronzo spazzolato.
Vetro soffiato: metallizzato bronzo superiore e metallizzato bronzo inferiore.
Diffusore bianco lucido.

*Satin bronze frame.
Hand blown glass: polished bronze upper glass and diffusing bronzed lower glass.
Top diffuser polished white.*

Cavo in tessuto nero con doppio interruttore On-Off /
Black fabric cable with double On-Off switch

L: 300 + 2000 mm
11.8 + 78.7 inches

Fonte luminosa / Light source

CE _____

KRONOS:

1 x E27 Compact Fluorescent 20 W
+
1 x E27 LED Filament 6 W

KAYROS:

1 x E27 Compact Fluorescent 20 W
+
1 x E27 LED Filament 8 W

Idoneo all'uso di lampadine LED /
Suitable for LED bulbs

CE

USA _____

KRONOS:

1 x E26 max 20 W
+
1 x E26 LED Filament 6 W

KAYROS:

1 x E26 max 20 W
+
1 x E26 LED Filament 8 W

Suitable for LED bulbs

BELLE

Design by STAFFAN TOLLGARD



Belle So





Belle Ap Small



Vedi Belle Ap Mini nella sezione dedicata
"TASK & READING" a pag 260

*See more of Belle Ap Mini in the
"TASK & READING" section on page 260*

Belle Ap Mini

BELLE

informazioni tecniche / technical info



Finiture / Finishes

SO / SO SMALL + AP SMALL



Diffusore in ceramica bianca.
Cavo intrecciato in seta grigia.



*Glossy white ceramic diffuser.
Grey braided silky cable.*



Diffusore in ceramica grigio fango lucido,
interno avorio lucido.



Cavo intrecciato in seta marrone

*Glossy grey mud ceramic diffuser,
glossy ivory lining.
Brown braided silky cable.*



DELUXE:

Diffusore in ceramica effetto bronzo lucido.
Cavo intrecciato in seta marrone.



DELUXE:

*Ceramic diffuser, polished bronze effect.
brown braided silky cable.*

Fonte luminosa / Light source

CE _____

SO / SO SMALL:

1 x E27 Reflector R8 Halogen
max 72 W

AP SMALL:

1 x E27 Halogen Energy Saving
max 28 W

*Idoneo all'uso di lampadine
LED e fluorescenti compatte /
Suitable for LED or compact
fluorescent bulbs (CFL)*

CE

USA _____

SO / SMALL:

1 x E26 Reflector R8
max 75 W

AP SMALL:

1 x E26 max 60 W

*Suitable for LED or compact
fluorescent bulbs (CFL)*

ETL
Intertek

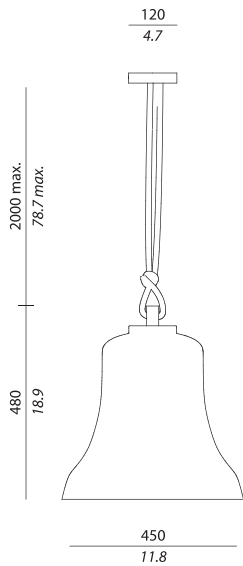

SO

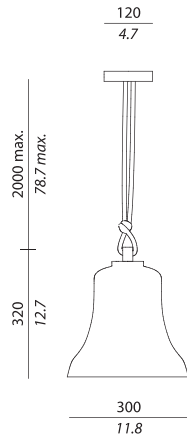

SO SMALL

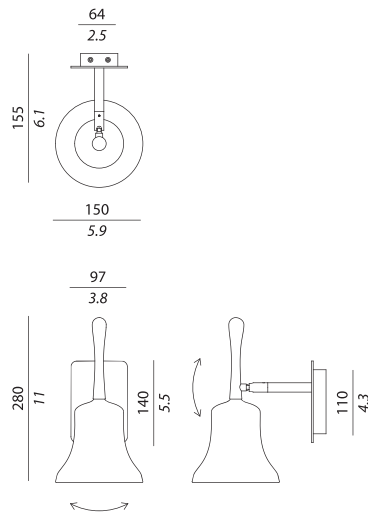

AP MINI

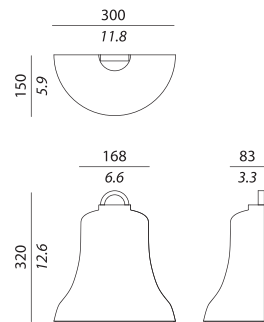

AP SMALL

Finiture / Finishes

AP MINI

-  Struttura laccata bianco.
Diffusore in vetro soffiato bianco lucido.
-  *White lacquered body.*
Polished white hand blown glass diffuser.

-  Struttura bronzo spazzolato.
Diffusore bronzo lucido metallizzato.

-  *Satin bronze body.*
Polished bronze diffuser.

Fonte luminosa / Light source

CE _____

AP MINI:
Custom LED 4 W
>500 Lm
2700 K , CRI: 90

USA _____

AP MINI:
Custom Led 4 W
>500 Lm
2700 K , CRI: 90



AGATA

Design by GIANLUIGI LANDONI



Agata Ta



Agata FI





Agata Ta

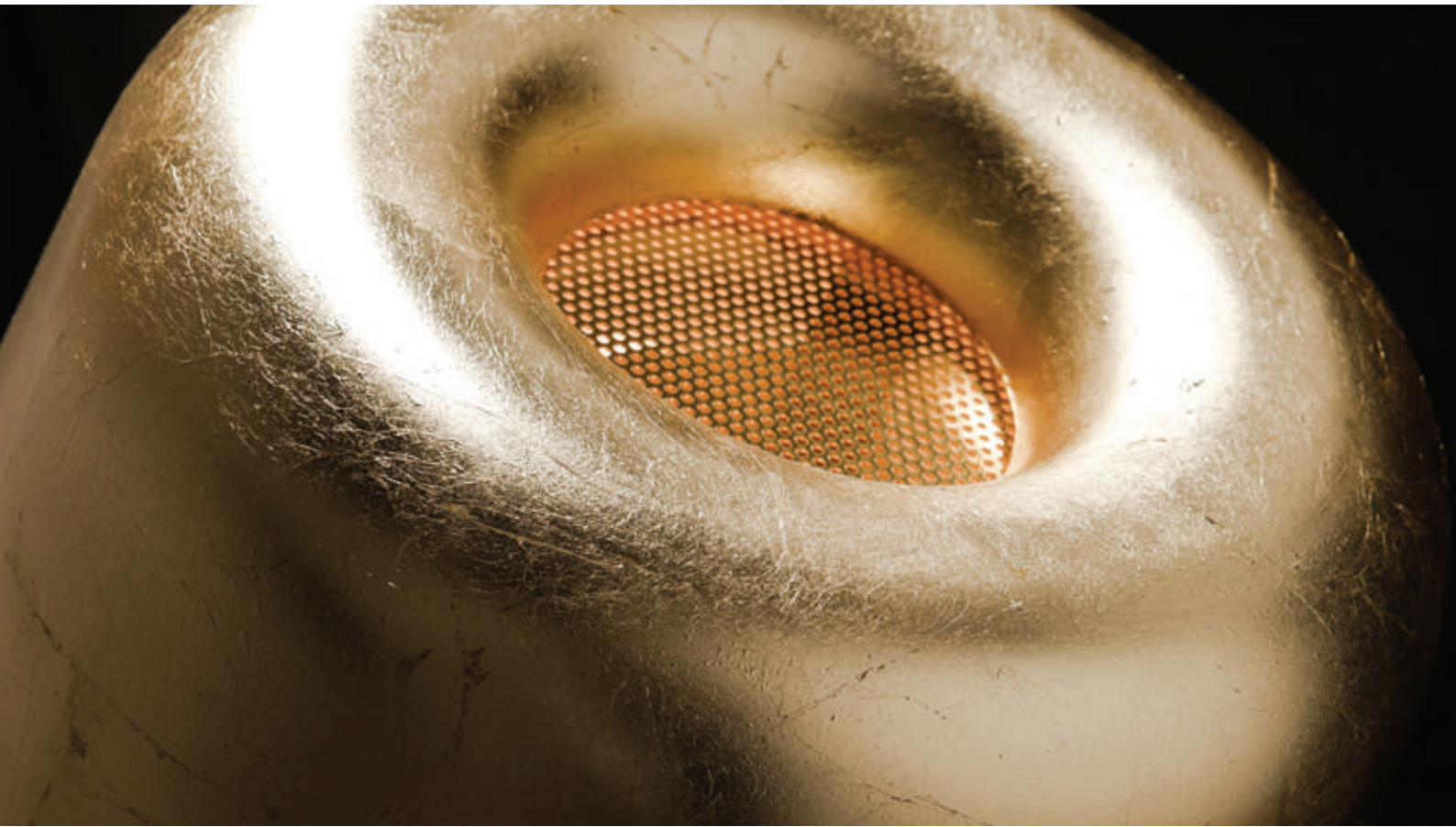

AGATA

informazioni tecniche / technical info

Paralume orientabile /
Orientable shade



Foglia oro /
Gold leaf

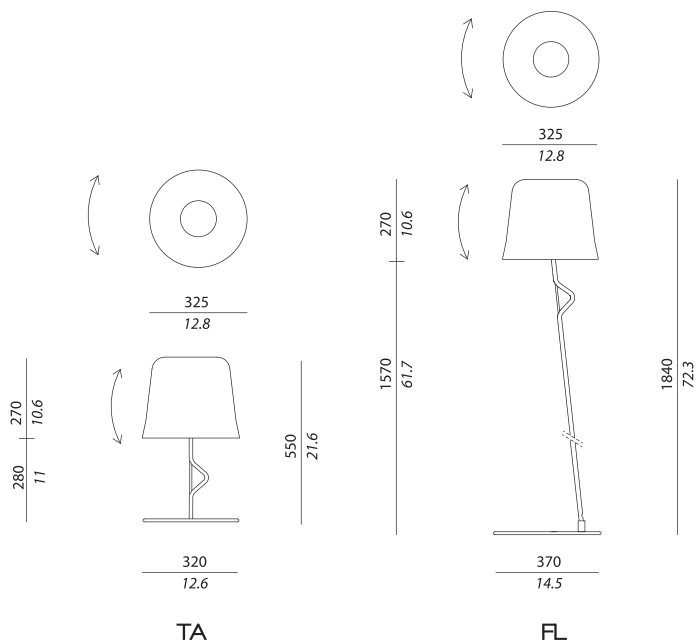

Finiture / Finishes



Struttura foglia oro.
Paralume metallico in foglia oro.

*Gold leaf body.
Gold leaf metal shade.*

TA:

Cavo in tessuto nero con interruttore On-Off /
Black fabric cable with On-Off switch

L: 300 + 2000 mm
11.8 + 78.7 inches

FL:

Cavo in tessuto nero con interruttore On-Off /
Black fabric cable with On-Off switch

L: 450 + 2000 mm
17.7 + 78.7 inches

Fonte luminosa / Light source

CE _____

TA: 2 x E27 Halogen Energy Saving
max 42 W

FL: 2 x E27 Halogen Energy Saving
max 42 W

USA _____

NOT AVAILABLE

Idoneo all'uso di lampadine
LED e fluorescenti compatte /
*Suitable for LED or compact
fluorescent bulbs (CFL)*

CE

MESSALINA

Design by MASSIMILIANO RAGGI



Messalina Ap



Messalina So



Messalina Ta Small

MESSALINA

informazioni tecniche / technical info

Metallo bronzo spazzolato o cromo /
Satin bronze or chrome metal



Vetro metallizzato cromo o bronzo /
Diffusing chromed glass or diffusing bronzed glass

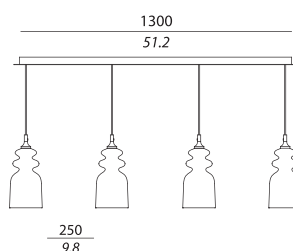
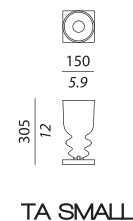
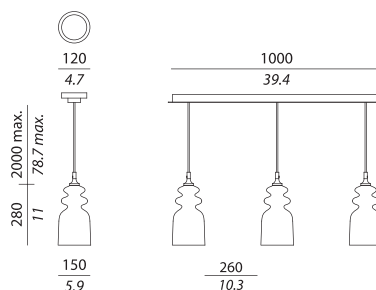

SO

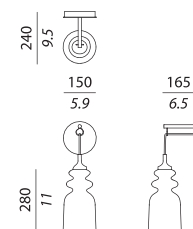

AP

Finiture / Finishes



Struttura cromo.
Vetro metallizzato cromo.



Chrome body.
Diffusing chromed glass.



Struttura bronzo.
Vetro metallizzato bronzo.



Satin bronze body.
Diffusing bronzed glass.

TA SMALL:

Cavo in tessuto nero
con interruttore dimmerabile /
Black fabric cable with dimmer switch

L: 300 + 2000 mm
11.8 + 78.7 inches

Fonte luminosa / Light source

CE _____

AP:
1 x E27 Halogen Energy Saving
max 70 W

TA SMALL:
1 x E27 Halogen Energy Saving
max 70 W

SO:
1 x E27 Halogen Energy saving
max 70 W

Idoneo all'uso di lampadine
LED / Suitable for LED bulbs

CE

USA _____

AP:
1 x E26 max 100 W

TA SMALL:
1 x E26 max 100 W

SO:
1 x E26 max 100 W

Suitable for LED bulbs

ETL
Intertek

CORNELIA

Design by MASSIMILIANO RAGGI



Cornelia Ta



Cornelia Fl



Cornelia So

CORNELIA

informazioni tecniche / technical info

Metallo bronzo spazzolato o cromo /
Satin bronze or chrome metal



Vetro metallizzato bronzo o cromo /
Diffusing bronzed or chromed glass

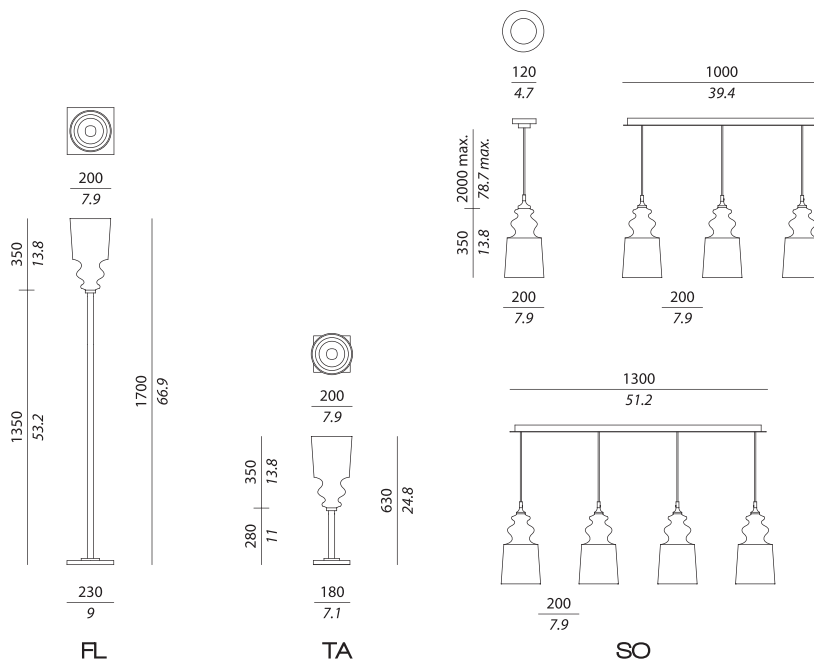

Finiture / Finishes



Struttura bronzo spazzolato.
Vetro metallizzato bronzo.



Satin bronze body.
Diffusing bronzed glass.



Struttura cromo.
Vetro metallizzato cromo.



Chrome body.
Diffusing chromed glass.

TA:

Cavo in tessuto nero con interruttore dimmerabile /
Black fabric cable with dimming switch

L: 300 + 2000 mm
11.8 + 78.7 inches

FL:

Cavo in tessuto nero con interruttore dimmerabile /
Black fabric cable with dimmer switch

L: 450 + 2000 mm
17.7 + 78.7 inches

Fonte luminosa / Light source

CE

TA:

1 x E27 Halogen Energy Saving
max 70 W

FL:

1 x E27 Halogen Energy Saving
max 105 W

SO:

1 x E27 Halogen Energy Saving
max 70 W

Idoneo all'uso di lampadine
LED e fluorescenti compatte /
*Suitable for LED or compact
fluorescent bulbs (CFL)*

CE

USA

TA:

1 x E26 max 100 W

FL:

1 x E26 max 100 W

SO:

1 x E26 max 75 W

*Suitable for LED or compact
fluorescent bulbs (CFL)*

ETL
Intertek

TREASURE

Design by MASSIMILIANO RAGGI



Treasure Ta

Guindani Do you know



Treasure Ta Deluxe



Treasure So Deluxe



Treasure So



Treasure Cluster of 3 Deluxe



Treasure Cluster of 3



TREASURE

informazioni tecniche / technical info

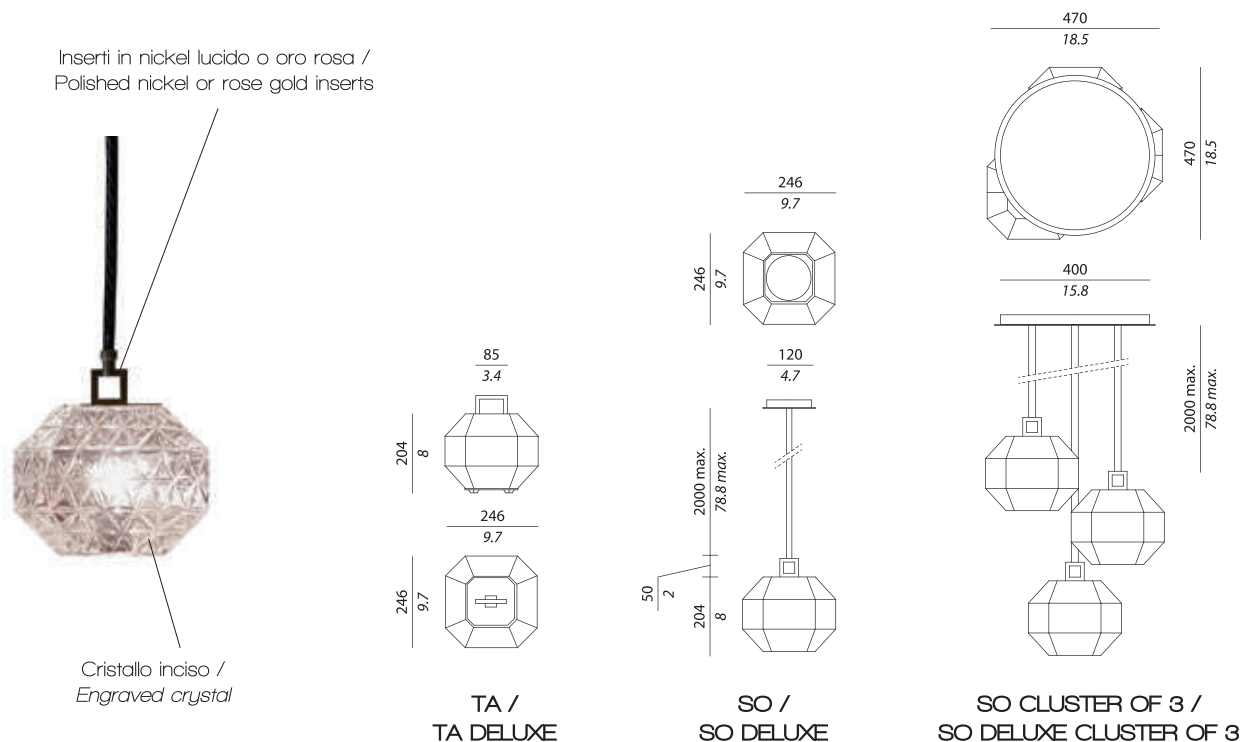

Finiture / Finishes



Base, maniglia e inserti in nickel lucido.
Cristallo inciso.

Base, handle and inserts in polished nickel.
Engraved crystal.

DELUXE



Base, maniglia e inserti in oro rosa.
Cristallo inciso, metallizzato oro rosa.

Base, handle and inserts in rose gold.
Engraved rose gold crystal.

TA / TA DELUXE:

Cavo in tessuto nero con interruttore dimmerabile /
Black fabric cable with dimming switch

L: 300 + 2000 mm
11.8 + 78.7 inches

Fonte luminosa / Light source

CE

TA / DELUXE TA:
1 x E27 Halogen Energy Saving
max 70 W

SO / DELUXE SO:
1 x E27 Halogen Energy Saving
max 70 W

CLUSTER OF 3 /
DELUXE CLUSTER OF 3:
3 x E27 Halogen Energy Saving
max 70 W

Idoneo all'uso di lampadine LED /
Suitable for LED bulbs



USA

TA / DELUXE TA:
1 x E26 LED 7 W

SO / DELUXE SO:
1 x E26 LED 7 W

CLUSTER OF 3 /
DELUXE CLUSTER OF 3:
3 x E26 LED 7 W

On/Off switch



BACH

Design by MASSIMILIANO RAGGI



Bach Ap





BACH

informazioni tecniche / technical info

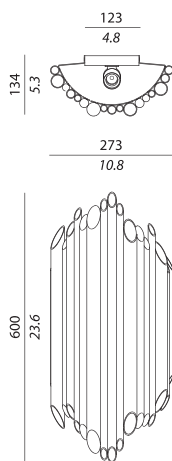



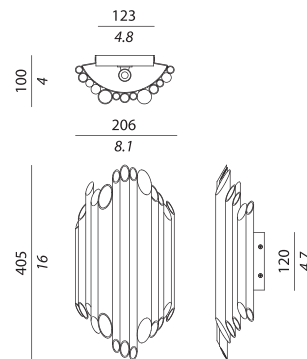

AP LARGE



AP SMALL

Finiture / Finishes

-  Struttura bronzo spazzolato.
Diffusore in plexiglass satinato.
-  *Satin bronze body.*
Satin plexiglass diffuser.
-  Struttura cromo.
Diffusore in plexiglass satinato.
-  *Chrome body.*
Satin plexiglass diffuser.

Fonte luminosa / Light source

CE _____

AP SMALL:
2 x E14 Halogen Energy Saving
max 28 W

AP LARGE:
2 x E14 Halogen Energy Saving
max 42 W

USA _____

AP SMALL:
2 x E12 max 40 W

AP LARGE:
2 x E12 max 60 W

Idoneo all'uso di lampadine
LED e fluorescenti compatte /
Suitable for LED or compact
fluorescent bulbs (CFL)

Suitable for LED or compact
fluorescent bulbs (CFL)



GEA

Design by MASSIMILIANO RAGGI



Gea Ap Large



Gea Ap IP44

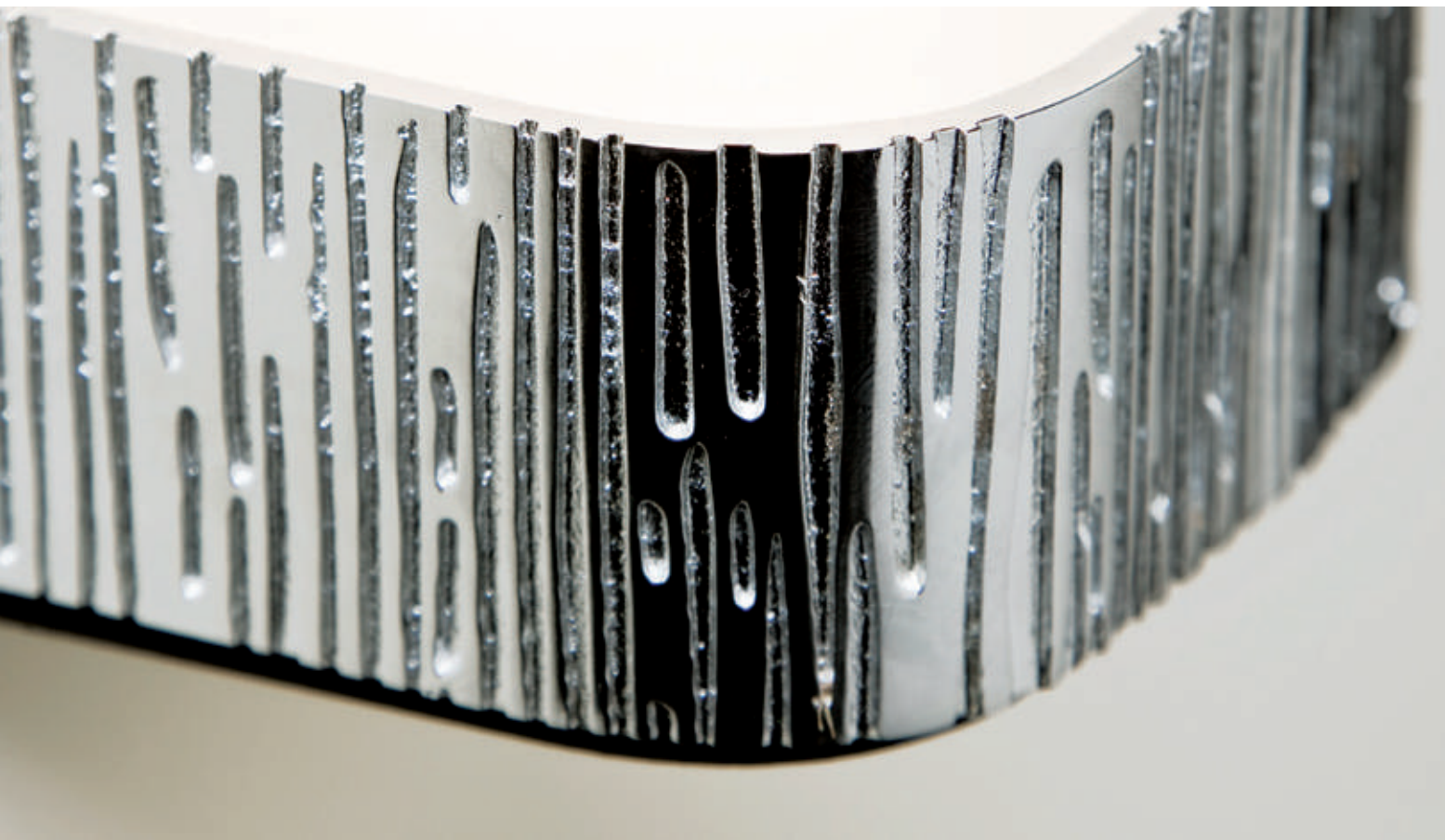

Vetro bianco acidato /
White acid etched glass



Fusione in ottone, finitura cromo o brunito /
Brass-cast metal belt, available in chrome or matt bronze finish

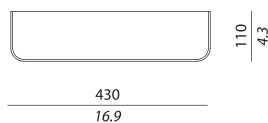

AP LARGE

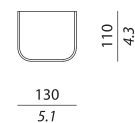

AP

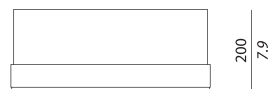

AP LARGE IP44

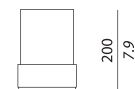

AP IP44

Finiture / Finishes



Fusione in ottone, finitura cromo.
Diffusore in vetro bianco acidato.



Brass-cast metal belt in chrome finish.
White acid etched glass diffuser.



Fusione in ottone, finitura brunito.
Diffusore in vetro bianco acidato.



Brass-cast metal belt, in matt bronze finish.
White acid etched glass diffuser.

Fonte luminosa / Light source

CE _____

AP:
1 x E27 Halogen Energy Saving
42 W

AP LARGE:
2 x E27 Halogen Energy Saving
42 W

AP IP44:
1 x G9 Halogen 42 W

AP LARGE IP44:
2 x G9 Halogen 42 W

Idoneo all'uso di lampadine
LED e fluorescenti compatte /
Suitable for LED or compact
fluorescent bulbs (CFL)

CE

USA _____

AP:
1 x E26 max 60 W

AP LARGE:
2 x E26 max 60 W

AP IP44:
1 x G9 Halogen 42 W

AP LARGE IP44:
2 x G9 Halogen 42 W

Suitable for LED or compact
fluorescent bulbs (CFL)



MANILLA

Design by GIANLUIGI LANDONI



Manilla Ta



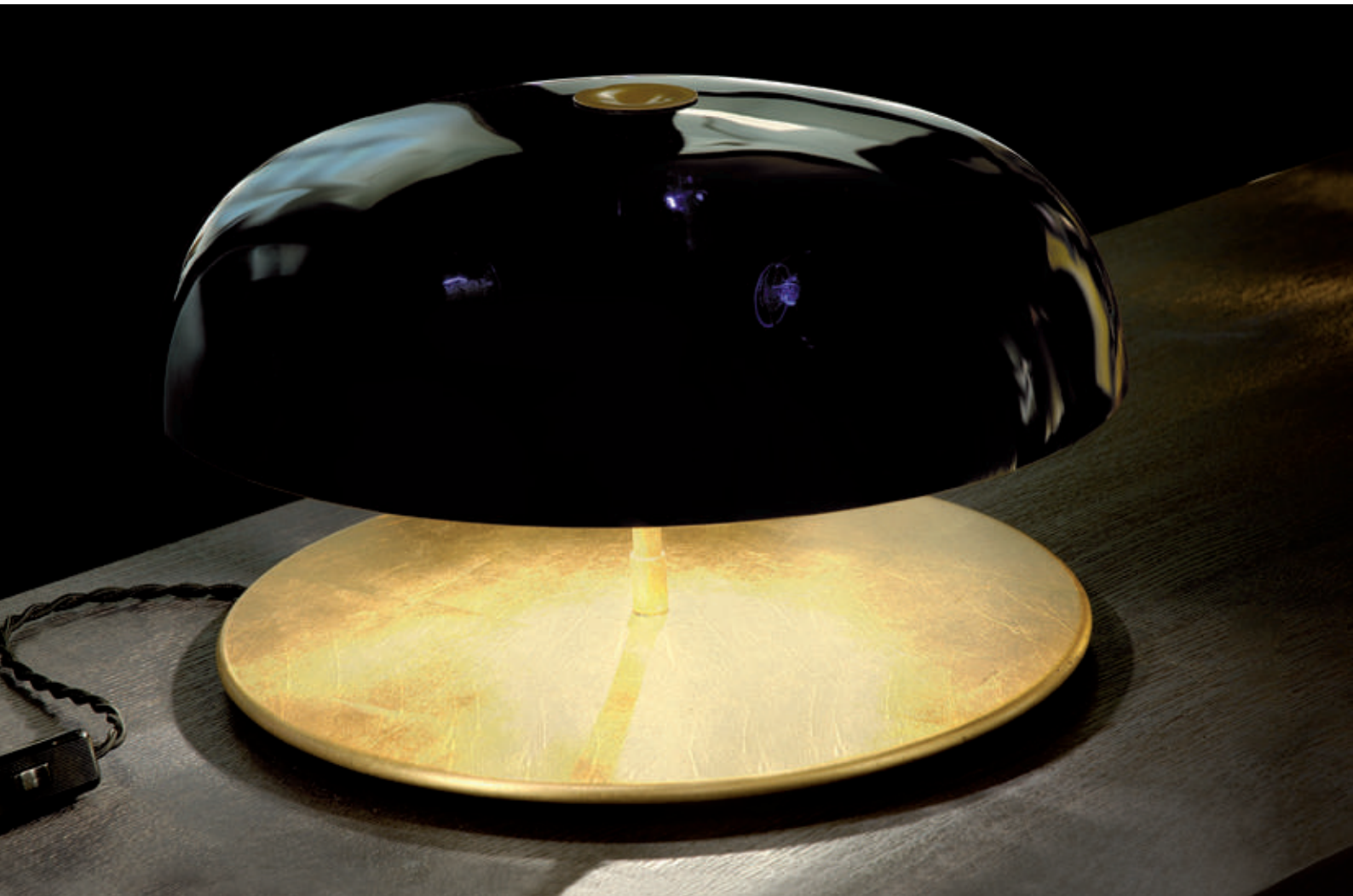

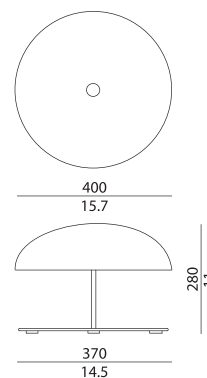

MANILLA

informazioni tecniche / technical info



TA

Finiture / Finishes

-  Struttura foglia oro.
Vetro soffiato nero lucido.
-  *Gold leaf body.*
Black blown glass.

Cavo in tessuto nero con interruttore On-Off /
Black fabric cable with On-Off switch

L: 300 + 2000 mm
11.8 + 78.7 inches

Fonte luminosa / Light source

CE _____
TA: 3 x E14 Compact Fluorescent
9 W

USA _____

TA: 3 x E12 LED 7 W

Idoneo all'uso di lampadine LED /
Suitable for LED bulbs

CE

Intertek

XXL

Design by GIANLUIGI LANDONI



XXL So



XXL FI





XXL So



Vedi XXL Outdoor nella sezione dedicata
"OUTDOOR" a pag 304

*See more of XXL Outdoor in the
"OUTDOOR" section on page 304*

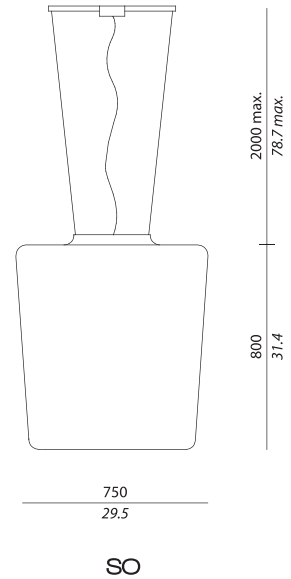
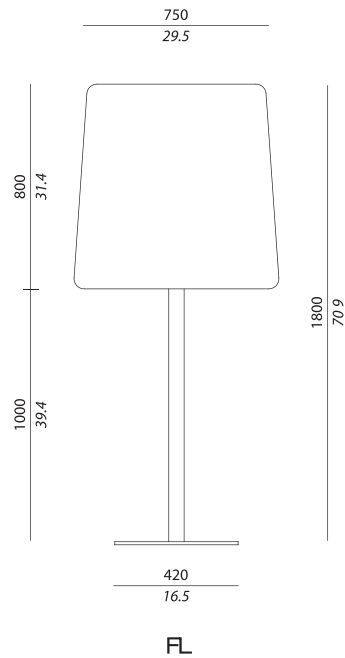

Finiture / Finishes

- Metallo laccato avorio.
Diffusore in vetroresina, color crema.
- Ivory lacquered metal.
Diffuser in fiberglass, cream colour.

FL:
Cavo in tessuto nero con interruttore On-Off /
Black fabric cable with On-Off switch
L: 450 + 2000 mm
17.7 + 78.7 inches

Fonte luminosa / Light source

CE _____
FL:
4 x E27 Compact Fluorescent
23 W

SO:
4 x E27 Compact Fluorescent
23 W

Idoneo all'uso di lampadine LED /
Suitable for LED bulbs



USA _____

FL:
4 x E26 Compact Fluorescent
23 W

SO:
4 x E26 Compact Fluorescent
23 W

Suitable for LED bulbs



ONGO CONNECT

Design by JESSICA CORR for TZELAN



Ongo Connect



Ongo XL



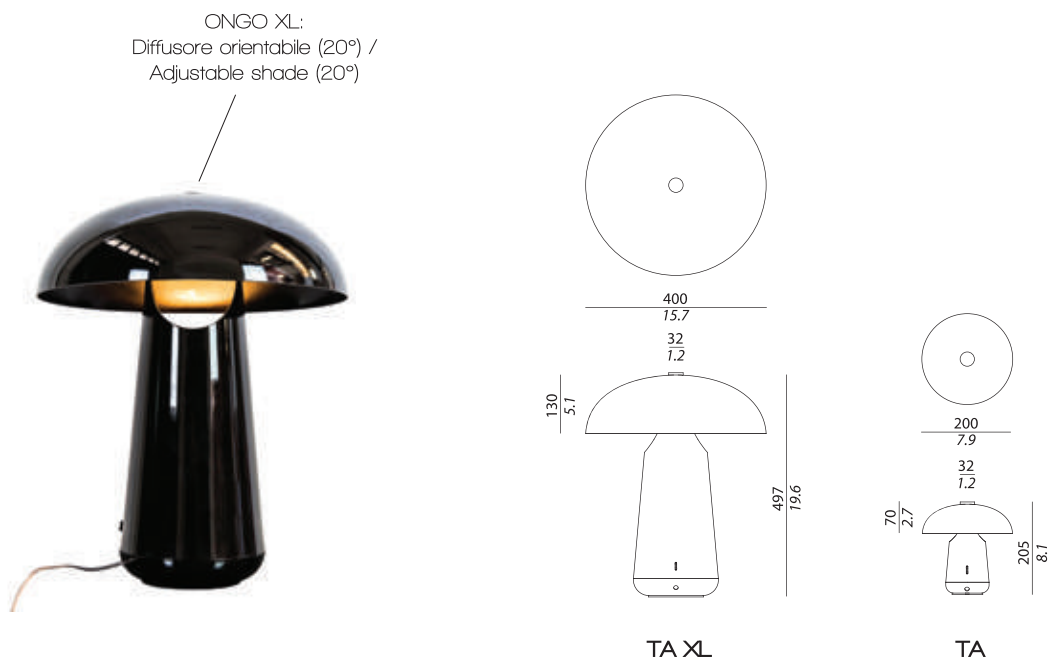

ONGO CONNECT

informazioni tecniche / technical info



Finiture / Finishes

-  Metallo verniciato bianco lucido.
Polished white lacquered metal.
-  Metallo verniciato blu notte lucido.
Polished night blue lacquered metal.
-  Metallo verniciato bronzo chiaro opaco.
Matt light bronze lacquered metal.

Cavo in tessuto grigio con interruttore On-Off /
Grey fabric cable with On-Off switch

L: 300 + 2000 mm
11.8 + 78.7 inches

Fonte luminosa / Light source

CE _____

TA:
1 x E14 LED
9 W

TA XL:
1 x E27 LED
12 W

USA _____

TA:
1 x E12 LED
12 W

TA XL:
1 x E26 LED
12 W

CE

Intertek



CLASSICS

AUDREY

FRAME

CLOCHE

M.ME BUTTERFLY

OOPS

COCO

QUADRA

RETTANGOLA

KIRA

ATHENA

COUTURE

DIVINA

LALA

CIRCUS

AUDREY

Design by MASSIMILIANO RAGGI



Audrey Ta



Audrey FI



Audrey Ta Large



Audrey So

AUDREY

informazioni tecniche / technical info



Stelo rivestito da corda in seta nera intrecciata /
Stem covered by black braided silk cord

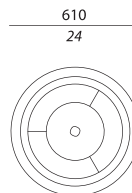

450
17.7

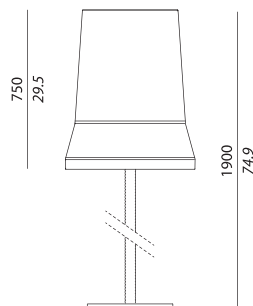

400
15.7

FL

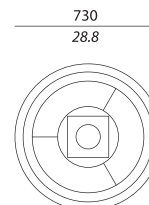

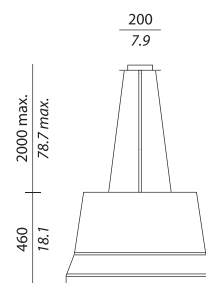

120
4.7





460
18.1

SO

Finiture / Finishes

-  Struttura laccata nero, con stelo in corda in seta nera intrecciato.
-  Paralume in cotone avorio, velluto avorio e passamaneria in raso avorio.
-  *Black frame, stem covered by black braided silk cord. Ivory cotton shade, ivory velvet and ivory silky trim.*

-  Struttura laccato nero, cavo intrecciato in seta nera.
-  Paralume in cotone avorio, velluto avorio e passamaneria in raso nero.
-  *Black frame, stem covered by black braided silk cord. Ivory cotton shade, ivory velvet and black silky trim.*

FL:
Cavo in tessuto nero con interruttore On-Off /
Black fabric cable with On-Off switch

L: 450 + 2000 mm
17.7 + 78.7 inches

Fonte luminosa / Light source

CE _____

FL:
2 x E27 Halogen Energy Saving
max 105 W +
1 x E27 Halogen Energy Saving
max 205 W

SO:
3 x E27 Halogen Energy Saving
max 105 W

Idoneo all'uso di lampadine
LED e fluorescenti compatte /
Suitable for LED or compact
fluorescent bulbs (CFL)

CE

USA _____

FL:
2 x E26 max 105 W +
1 x E26 max 205 W

SO:
3 x E26 max 105 W

Suitable for LED or compact
fluorescent bulbs (CFL)

Intertek

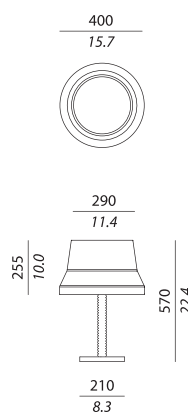



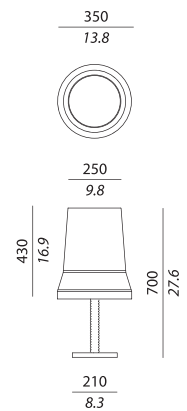





TA MEDIUM



TA LARGE

Finiture / Finishes

-  Struttura laccata nero, con stelo in corda in seta nera intrecciato.
-  Paralume in cotone avorio, velluto avorio e passamaneria in raso avorio.
-  *Black frame, stem covered by black braided silk cord.*
-  *Ivory cotton shade, ivory velvet and ivory silky trim.*

-  Struttura laccato nero, cavo intrecciato in seta nera.
-  Paralume in cotone avorio, velluto avorio e passamaneria in raso nero.
-  *Black frame, stem covered by black braided silk cord.*
-  *Ivory cotton shade, ivory velvet and black silky trim.*

TA:
Cavo in tessuto nero con interruttore On-Off /
Black fabric cable with On-Off switch

L: 300 + 2000 mm
11.8 + 78.7 inches

Fonte luminosa / Light source

CE _____

TA:
1 x E27 Halogen Energy Saving
medium: max 70 W
large: max 70 W

Idoneo all'uso di lampadine
LED e fluorescenti compatte /
*Suitable for LED or compact
fluorescent bulbs (CFL)*



USA _____

TA:
1 x E26
medium: max 75 W
large: max 75 W

*Suitable for LED or compact
fluorescent bulbs (CFL)*



FRAME

Design by GIANLUIGI LANDONI



Frame FI (Mrs)



Frame FI (Mr)



Frame Ta (Miss)

FRAME

informazioni tecniche / technical info

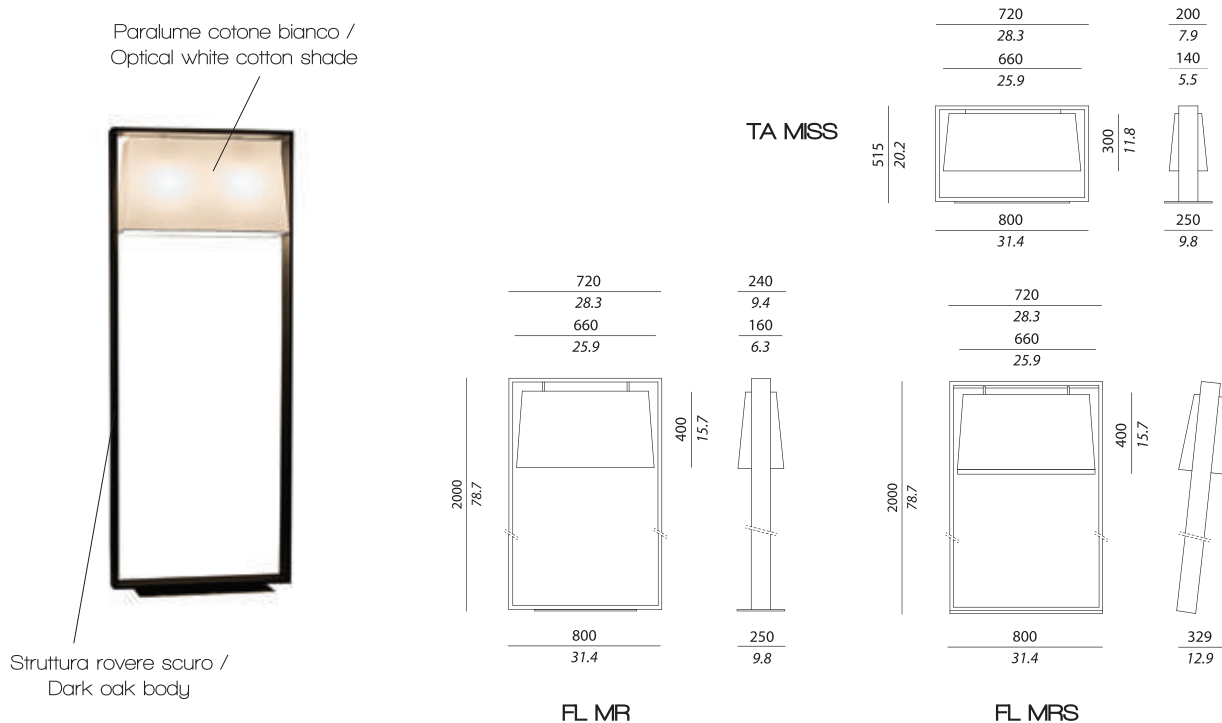

Finiture / Finishes

- Struttura rovere scuro.
Paralume cotone bianco.
- Dark oak body.
Optical white cotton shade.

FL MR / FL MRS:
Cavo in tessuto nero con interruttore On-Off /
Black fabric cable with On-Off switch

L: 450 + 2000 mm
17.7 + 78.7 inches

TA MISS:
Cavo in tessuto nero con interruttore On-Off /
Black fabric cable with On-Off switch

L: 300 + 2000 mm
11.8 + 78.7 inches

Fonte luminosa / Light source

CE _____

FL MR:
2 x E27 Compact Fluorescent
23 W

FL MRS:
2 x E27 Compact Fluorescent
23 W

TA MISS:
2 x E27 Compact Fluorescent
18 W

Idoneo all'uso di lampadine LED /
Suitable for LED bulbs

CE

USA _____

FL MR:
2 x E26 max 60 W

FL MRS:
2 x E26 max 60 W

TA MISS:
2 x E26 max 60 W

Suitable for LED or compact
fluorescent bulbs (CFL)

ETL
Intertek

CLOCHE

Design by MASSIMILIANO RAGGI



Cloche Ta



Cloche FI



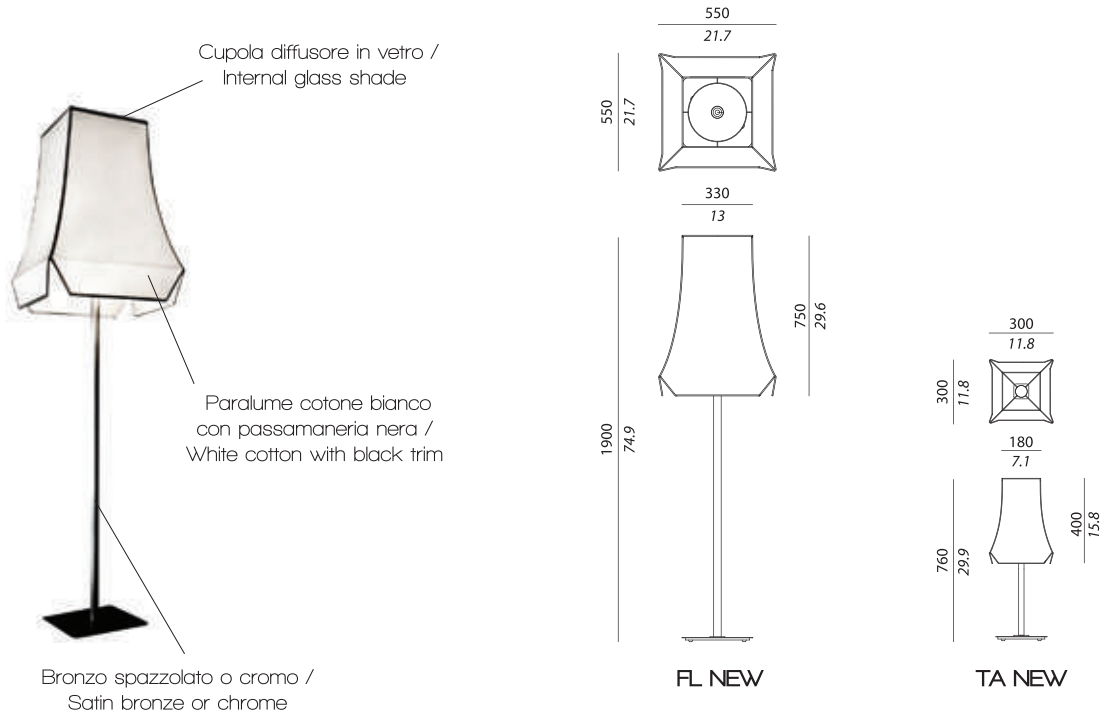

CLOCHE

informazioni tecniche / technical info



Finiture / Finishes

- 
 Struttura in bronzo spazzolato.
 Paralume cotone bianco
 con passamaneria nera.
*Satin bronze body.
 White cotton shade with black trim.*
- 
 Struttura in cromo.
 Paralume cotone bianco
 con passamaneria nera.
*Chrome body.
 White cotton shade with black trim.*

FL NEW:
 Cavo in tessuto nero con interruttore On-Off /
Black fabric cable with On-Off switch
 L: 450 + 2000 mm
 17.7 + 78.7 inches

TA NEW:
 Cavo in tessuto nero con interruttore On-Off /
Black fabric cable with On-Off switch
 L: 300 + 2000 mm
 11.8 + 78.7 inches

Fonte luminosa / Light source

- CE _____
- FL:
 2 x E27 Halogen Energy Saving
 max 105 W +
 1 x E27 Halogen Energy Saving
 max 205 W
- TA:
 1 x E27 Halogen Energy Saving
 max 42 W

Idoneo all'uso di lampadine
 LED e fluorescenti compatte /
*Suitable for LED or compact
 fluorescent bulbs (CFL)*

CE

USA _____

- FL:
 2 x E26 max 105 W +
 1 x E26 max 205 W
- TA:
 1 x E26 max 75 W

*Suitable for LED or compact
 fluorescent bulbs (CFL)*

ETL
 Intertek

M.ME BUTTERFLY

Design by GIANLUIGI LANDONI



M.me Butterfly





M.ME BUTTERFLY

informazioni tecniche / technical info

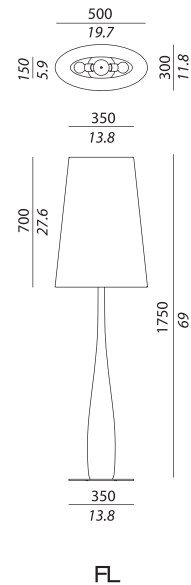

Finiture / Finishes



Stelo in legno, finitura grigio "canna da fucile" lucido.

Paralume seta avorio.

*Polished gunmetal grey wood stem.
Ivory silk shade.*

FL:

Cavo in tessuto nero con interruttore On-Off /
Black fabric cable with On-Off switch

L: 450 + 2000 mm
17.7 + 78.7 inches

Fonte luminosa / Light source

CE _____

FL: 2 x E27 Compact Fluorescent
20 W

USA _____

FL: 2 x E26 max 60 W

Idoneo all'uso di lampadine LED /
Suitable for LED bulbs

Suitable for LED bulbs

CE



OOPS

Design by GIANLUIGI LANDONI



Oops





OOPS

informazioni tecniche / technical info

Legno noce canaletto /
Canaletto walnut wood



Cotone bianco /
White cotton

Dettagli in alluminio anodizzato /
Anodized aluminium details

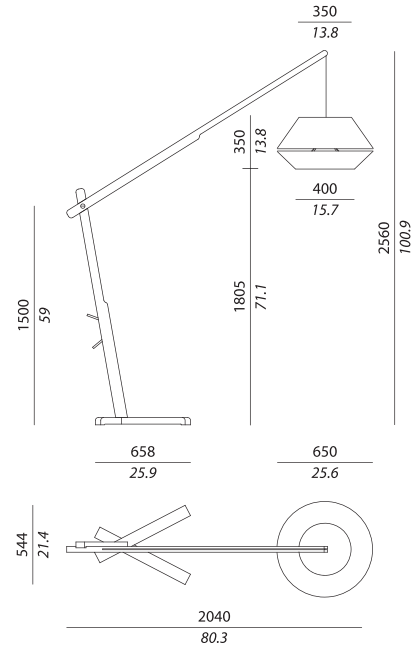

FL

Finiture / Finishes

■ Struttura in legno noce canaletto.
Paralume in cotone bianco.

□ *Canaletto walnut wood.*
White cotton shade.

FL:
Cavo in tessuto nero con interruttore On-Off /
Black fabric cable with On-Off switch

L: 450 + 2000 mm
17.7 + 78.7 inches

Fonte luminosa / Light source

CE _____

FL:
1 x E27 Compact Fluorescent
30 W

USA _____

FL:
1 x E26 Compact Fluorescent
30 W

Idoneo all'uso di lampadine LED /
Suitable for LED bulbs

Suitable for LED bulbs

CE

ETL
Intertek

COCO

Design by TRISTAN AUER



Coco Mega Ta (& Coco Deluxe Ta)



Coco Mega Ap



Coco Deluxe Ap



Coco Deluxe Ta



Coco Ap



Coconette Ap



Coco Ap Mini IP44



Vedi Coco Mega Outdoor nella sezione dedicata
"OUTDOOR" a pag 300

*See more of Coco Mega Outdoor in the
"OUTDOOR" section on page 300*

COCO

informazioni tecniche / technical info

Specchio molato applicato alla base /
Bevelled mirror mounted on the base



Cotone bianco o lino bianco /
White cotton or white linen

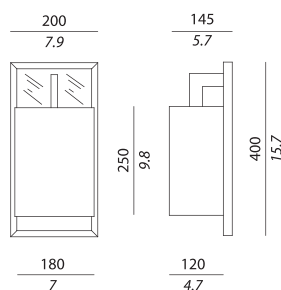

AP

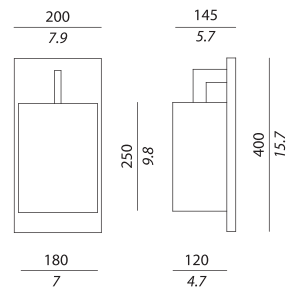

COCONETTE

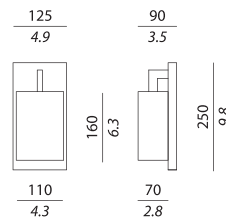

AP MINI IP44

Finiture / Finishes

- AP
Struttura cromo lucido.
Paralume cotone bianco o lino bianco.
*Chrome body.
White cotton or white linen shade.*
- AP MINI IP44
Struttura cromo.
Paralume in tessuto impermeabile bianco.
*Chrome body.
Waterproof white fabric shade.*
- COCONETTE
Struttura bronzo spazzolato.
Paralume in cotone bianco, lino bianco,
shantung grigio chiaro o shantung bronzo.
*Satin bronze body.
White cotton, white linen, bronze shantung
or light grey shantung shade.*

Fonte luminosa / Light source

CE _____
AP:
1 x E27 Halogen Energy Saving
42 W

AP MINI IP44:
1 x G9 Halogen 28 W

COCONETTE:
1 x E27 Halogen Energy Saving
42 W

Idoneo all'uso di lampadine
LED e fluorescenti compatte /
Suitable for LED or compact
fluorescent bulbs (CFL)



USA _____

AP:
1 x E26 max 60 W

AP MINI IP44:
1 x G9 max 28 W

COCONETTE:
1 x E26 max 60 W

Suitable for LED or compact
fluorescent bulbs (CFL)





Specchio molato incassato nella cornice /
Bevelled silver mirror recessed in the frame

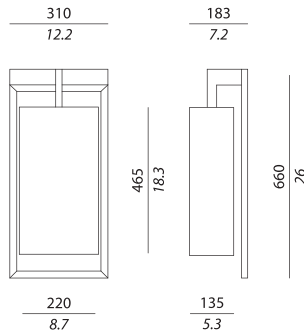

MEGA AP

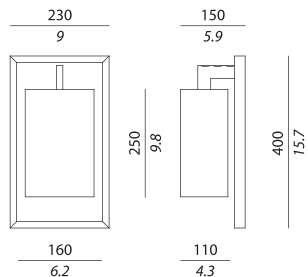

DELUXE AP

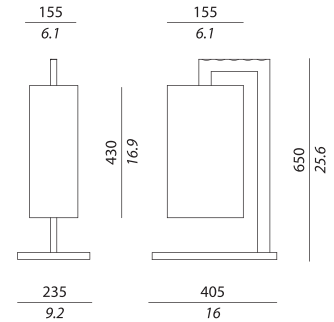

MEGA TA

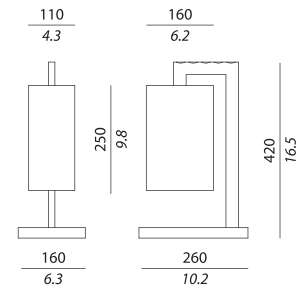

DELUXE TA

Finiture / Finishes



Struttura cromo.
Riflettore in specchio molato.
Paralume percaline bianco.
*Chrome body.
Bevelled silver mirror.
White percaline shade.*



Struttura cromo.
Riflettore in specchio molato.
Paralume percaline bianco - interno oro.
*Chrome body.
Bevelled silver mirror.
White percaline shade with gold lining.*

MEGA TA / DELUXE TA:
Cavo in tessuto nero con interruttore On-Off /
Black fabric cable with On-Off switch

L: 300 + 2000 mm
11.8 + 78.7 inches

Fonte luminosa / Light source

CE

MEGA AP:
1 x E27 Compact Fluorescent
23 W

MEGA TA:
1 x E27 Compact Fluorescent
23 W

DELUXE AP:
1 x E27 Halogen Energy Saving
42 W

DELUXE TA:
1 x E27 Halogen Energy Saving
42 W

*Idoneo all'uso di lampadine
LED e fluorescenti compatte /
Suitable for LED or compact
fluorescent bulbs (CFL)*



USA

MEGA AP:
1 x E26 23 W

MEGA TA:
1 x E26 23 W

DELUXE AP:
1 x E26 max 60 W

DELUXE TA:
1 x E26 max 60 W

*Suitable for LED or compact
fluorescent bulbs (CFL)*



QUADRA

Design by ALLTOGETHER



Quadra Ta



Quadra Desk



Quadra Liseuse



Quadra FI



Quadra Ap Mini IP44



Quadra Led Ap



Quadra Ap



Quadra Joint Ap

QUADRA

informazioni tecniche / technical info

Cotone bianco, lino bianco, shantung grigio chiaro o bronzo /
White cotton, white linen, light grey shantung or bronze shantung

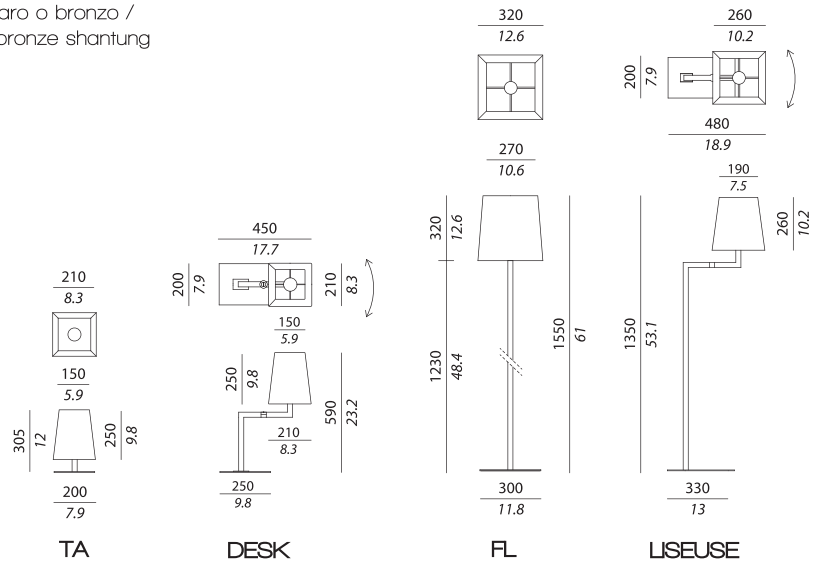

Finiture / Finishes



Struttura bronzo spazzolato o cromo.
Paralume cotone bianco o lino bianco.

*Satin bronze or chrome body,
White cotton or white linen shade.*



Struttura bronzo spazzolato o cromo.
Paralume shantung grigio chiaro o shantung
bronzo.

*Satin bronze or chrome body,
Light grey shantung or bronze shantung shade.*

TA / TA DESK:

Cavo in tessuto nero con interruttore On-Off /
Black fabric cable with On-Off switch

L: 300 + 2000 mm
11.8 + 78.7 inches

FL / LISEUSE:

Cavo in tessuto nero con interruttore On-Off /
Black fabric cable with On-Off switch

L: 450 + 2000 mm
17.7 + 78.7 inches

Fonte luminosa / Light source

CE _____

TA:
1 x E27 Halogen Energy Saving
42 W

DESK:
1 x E27 Halogen Energy Saving
42 W

FL:
1 x E27 Halogen Energy Saving
70 W

LISEUSE:
1 x E27 Halogen Energy Saving
42 W

*Idoneo all'uso di lampadine
LED e fluorescenti compatte /
Suitable for LED or compact
fluorescent bulbs (CFL)*



USA _____

TA:
1 x E26 max 100 W

DESK:
1 x E26 max 100 W

FL:
1 x E26 max 100 W

LISEUSE:
1 x E26 max 100 W

*Suitable for LED or compact
fluorescent bulbs (CFL)*





Quadra Ap Mini con diffusore in shantung bronzo.
Disponibile anche nella versione IP44 con tessuto impermeabile
bianco e lampadina G9 28 W /

Quadra Ap Mini with bronze shantung diffuser.
Also available the IP44 version with white waterproof fabric
and G9 halogen bulb 28 W

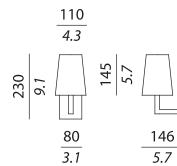

AP MINI

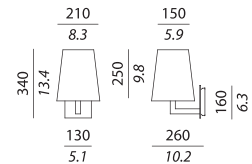

AP

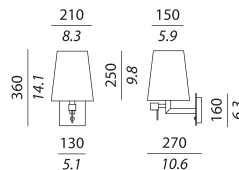

LED AP

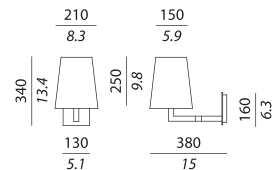

JOINT AP

Finiture / Finishes

 Struttura bronzo spazzolato o cromo.
Paralume cotone bianco.

 *Satin bronze or chrome body.*
White cotton shade.

 Struttura bronzo spazzolato o cromo.
Paralume lino bianco.

 *Satin bronze or chrome body.*
White linen shade.

 Struttura bronzo spazzolato o cromo.
Paralume shantung bronzo.

 *Satin bronze or chrome body.*
Bronze shantung shade.

 Struttura bronzo spazzolato o cromo.
Paralume shantung grigio chiaro.

 *Satin bronze or chrome body.*
Light grey shantung shade.

Fonte luminosa / Light source

CE _____

AP MINI:
1 x E14 Halogen Energy Saving
28 W

AP:
1 x E27 Halogen Energy Saving
42 W

LED AP:
1 x E27 Halogen Energy Saving
42 W
+ Custom LED 3 W 500 Lm

JOINT AP:
1 x E27 Halogen Energy Saving
42 W

*Idoneo all'uso di lampadine
LED e fluorescenti compatte /
Suitable for LED or compact
fluorescent bulbs (CFL)*



USA _____

AP MINI:
1 x E12 max 60 W

AP:
1 x E26 max 100 W

LED AP:
1 x E26 max 100 W
+ Custom LED 3 W 500 Lm

JOINT AP:
1 x E26 max 100 W

*Suitable for LED or compact
fluorescent bulbs (CFL)*



RETTANGOLA

Design by ALLTOGETHER



Rettangola Ta Small (& Rettangola Ta)



Rettangola Ta



Rettangola FI

RETTANGOLA

informazioni tecniche / technical info

Cotone bianco, lino bianco, shantung grigio chiaro o bronzo /
White cotton, white linen, light grey shantung or bronze shantung



Bronzo spazzolato o cromo /
Satin bronze or chrome

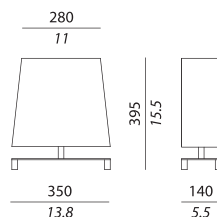

TA SMALL

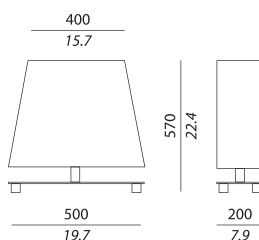

TA

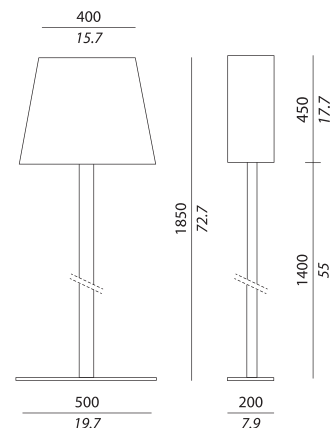

FL

Finiture / Finishes



Struttura bronzo spazzolato o cromo.
Paralume cotone bianco o lino bianco.

*Satin bronze or chrome body.
White cotton or white linen shade.*



Struttura bronzo spazzolato o cromo.
Paralume shantung grigio chiaro o bronzo.

*Satin bronze or chrome body.
Light grey or bronze shantung shade.*

TA / TA SMALL:

Cavo in tessuto nero con interruttore On-Off /
Black fabric cable with On-Off switch

L: 300 + 2000 mm
11.8 + 78.7 inches

FL:

Cavo in tessuto nero con interruttore On-Off /
Black fabric cable with On-Off switch

L: 450 + 2000 mm
17.7 + 78.7 inches

Fonte luminosa / Light source

CE _____

TA - TA SMALL:
1 x E27 Halogen Energy Saving
70 W

FL:
1 x E27 Halogen Energy Saving
70 W

Idoneo all'uso di lampadine
LED e fluorescenti compatte /
Suitable for LED or compact
fluorescent bulbs (CFL)

CE

USA _____

TA - TA SMALL:
1 x E26 max 100 W

FL:
1 x E26 max 100 W

Suitable for LED or compact
fluorescent bulbs (CFL)

ETL
Intertek

KIRA

Design by MASSIMILIANO RAGGI



Kira Ap IP44



Kira Ta

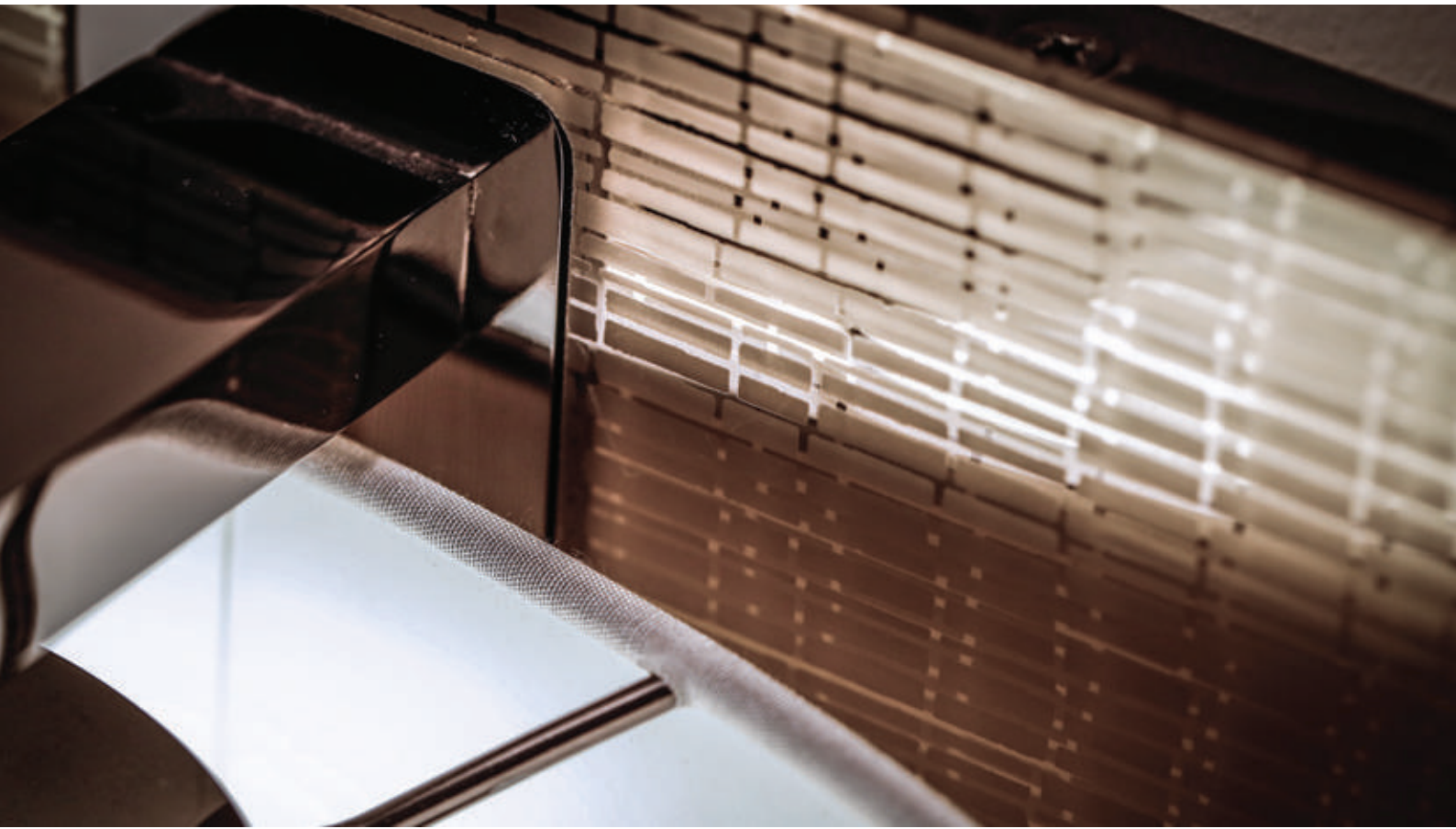

KIRA



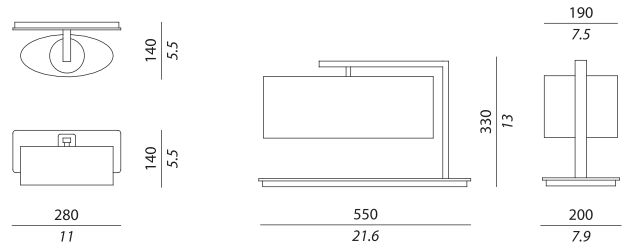



informazioni tecniche / technical info



AP IP44

TA

Finiture / Finishes

-  Struttura nickel nero lucido.
-  Base a specchio finitura bronzo con decoro geometrico.
-  Paralume percaline bianco.
-  *Black nickel body.*
-  *Patterned bronze mirror base.*
-  *White percaline shade.*

TA:
Cavo in tessuto nero con interruttore On-Off /
Black fabric cable with On-Off switch

L: 300 + 2000 mm
11.8 + 78.7 inches

Fonte luminosa / Light source

CE _____

AP IP44:
1 x G9 Halogen Energy Saving
28 W

TA:
2 x E14 Halogen Energy Saving
42 W

Idoneo all'uso di lampadine
LED e fluorescenti compatte /
*Suitable for LED or compact
fluorescent bulbs (CFL)*

CE

USA _____

AP IP44:
1 x G9 max 28 W

TA:
2 x E12 max 60 W

*Suitable for LED or compact
fluorescent bulbs (CFL)*

 ETL
Intertek

ATHENA

Design by MASSIMILIANO RAGGI



Athena Ta









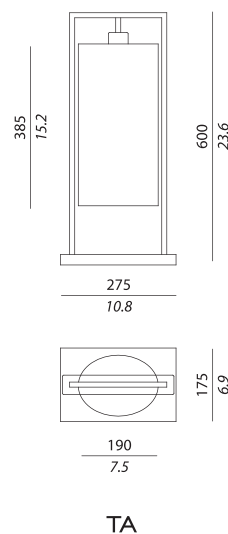

ATHENA

informazioni tecniche / technical info



Finiture / Finishes

 Struttura nickel nero.
Base in legno di rovere tinto marrone scuro.
 Paralume in percaline bianco.
 *Black nickel body.*
Dark brown oak base.
White percaline shade.

 Struttura nickel nero.
Base in legno di rovere tinto marrone scuro.
 Paralume in lino.
 *Black nickel body.*
Dark brown oak base.
White linen shade.

TA:
Cavo in tessuto nero con interruttore On-Off /
Black fabric cable with On-Off switch

L: 300 + 2000 mm
11.8 + 78.7 inches

Fonte luminosa / Light source

CE _____

TA:
1 x E27 Halogen Energy Saving
42 W

Idoneo all'uso di lampadine
LED e fluorescenti compatte /
*Suitable for LED or compact
fluorescent bulbs (CFL)*

CE

USA _____

TA:
1 x E26 max 60 W

*Suitable for LED or compact
fluorescent bulbs (CFL)*

Intertek

COUTURE

Design by DANIELE LO SCALZO MOSCHERI



Couture Fl



Couture FI Long



Couture Ta

COUTURE

informazioni tecniche / technical info



Bronzo spazzolato o nickel satinato /
Satin bronze or satin nickel

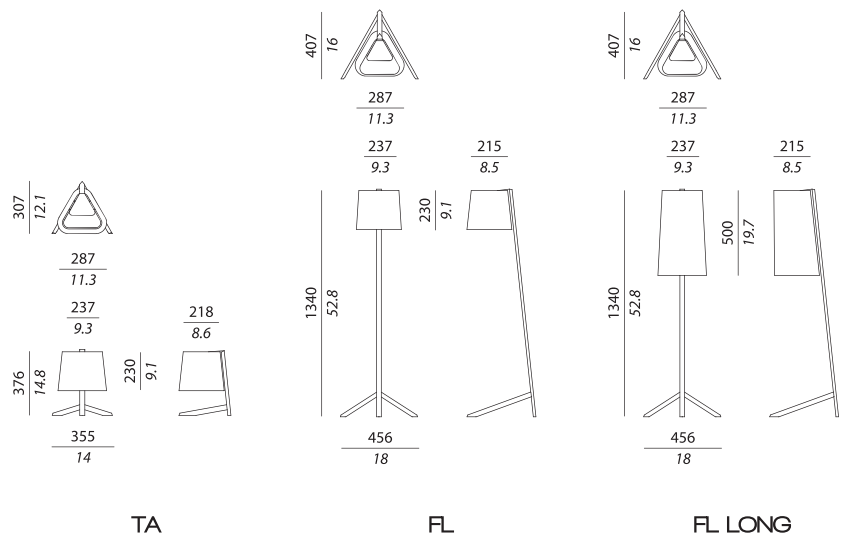

Finiture / Finishes



Struttura in bronzo spazzolato o nickel satinato.
Cotone bianco con passamaneria
in oper grigio chiaro.

*Satin bronze or satin nickel body.
White cotton shade with oper grey trim.*

FL / FL LONG:

Cavo in tessuto nero con interruttore On-Off /
Black fabric cable with On-Off switch

L: 450 + 2000 mm
17.7 + 78.7 inches

TA:

Cavo in tessuto nero con interruttore On-Off /
Black fabric cable with On-Off switch

L: 300 + 2000 mm
11.8 + 78.7 inches

Fonte luminosa / Light source

CE _____

TA:
1 x E27 Halogen Energy Saving
42 W

FL:
1 x E27 Halogen Energy Saving
42 W

FL LONG:
1 x E27 Halogen Energy Saving
42 W

*Idoneo all'uso di lampadine
LED e fluorescenti compatte /
Suitable for LED or compact
fluorescent bulbs (CFL)*



USA _____

TA:
1 x E26 max 75 W

FL:
1 x E26 max 75 W

FL LONG:
1 x E26 max 75 W

*Suitable for LED or compact
fluorescent bulbs*



DMINA

Design by GIANLUIGI LANDONI



Divina Ta



Divina FI Medium



Divina FI Large



Divina FI Arco



Divina So (Medium & Large)



Divina So XL



Divina Ap

DMINA

informazioni tecniche / technical info

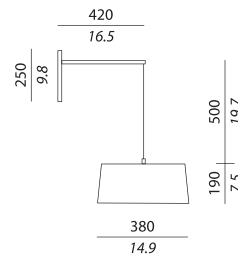
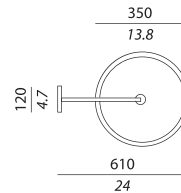

AP

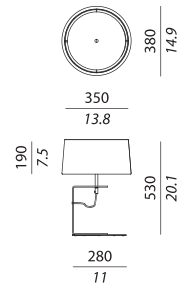

TA

Finiture / Finishes

 Struttura cromo con cavo nero.
Paralume plissettato color crema.

 Chrome body with black cable.
Cream pleated shade.

 Struttura cromo con cavo rosso.
Paralume plissettato color nero.

 Chrome body with red cable.
Black pleated shade.

 Struttura cromo con cavo nero.
Paralume plissettato color bianco.

 Chrome body with black cable.
White pleated shade.

TA:
Cavo in tessuto con interruttore dimmer /
Fabric cable with dimmer switch

L: 300 + 2000 mm
11.8 + 78.7 inches

Fonte luminosa / Light source

CE _____

TA
2 x E27 Halogen Energy Saving
42 W

AP:
2 x E27 Halogen Energy Saving
28 W

Idoneo all'uso di lampadine
LED e fluorescenti compatte /
Suitable for LED or compact
fluorescent bulbs (CFL)

CE

USA _____

TA:
2 x E26 max 60 W

AP:
2 x E26 max 60 W

Suitable for LED or compact
fluorescent bulbs (CFL)

Intertek

DMNA

informazioni tecniche / technical info

Plissé color crema, nero o bianco /
Black, cream or white pleated



DMNA FL ARCO:
Disponibile con struttura laccata
bianco o bronzo / Available with white
or bronze lacquered body

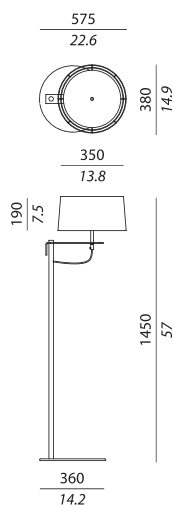

FL MEDIUM

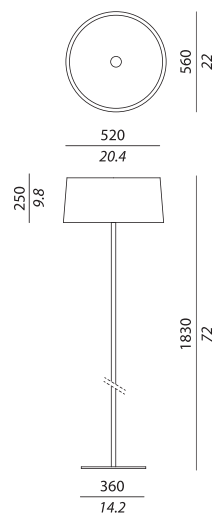

FL LARGE

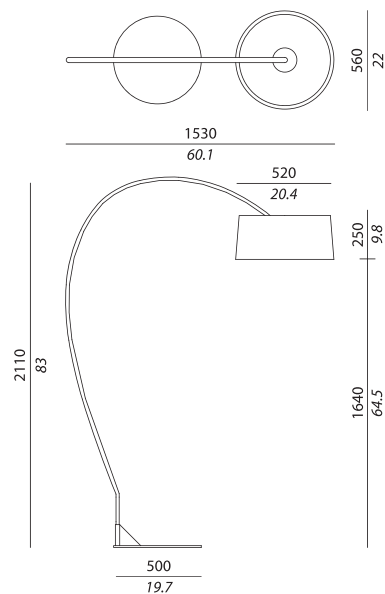

FL ARCO

Finiture / Finishes

-  Struttura cromo con cavo nero.
Paralume plissettato color crema.
*Chrome body with black cable.
Cream pleated shade.*
-  Struttura cromo con cavo rosso.
Paralume plissettato color nero.
*Chrome body with red cable.
Black pleated shade.*
-  Struttura cromo con cavo nero.
Paralume plissettato color bianco.
*Chrome body with black cable.
White pleated shade.*

FL MEDIUM / LARGE / ARCO:
Cavo in tessuto con interruttore dimmer /
Fabric cable with dimmer switch

L: 450 + 2000 mm
17.7 + 78.7 inches

Fonte luminosa / Light source

CE _____

FL MEDIUM:
2 x E27 Halogen Energy Saving
42 W

FL LARGE:
2 x E27 Halogen Energy Saving
70 W

FL ARCO:
2 x E27 Halogen Energy Saving
70 W

Idoneo all'uso di lampadine
LED e fluorescenti compatte /
Suitable for LED or compact
fluorescent bulbs (CFL)

CE

USA _____

FL MEDIUM:
2 x E26 max 60 W

FL LARGE:
2 x E26 max 75 W

FL ARCO:
2 x E26 max 75 W

Suitable for LED or compact
fluorescent bulbs (CFL)



 ETL
Intertek



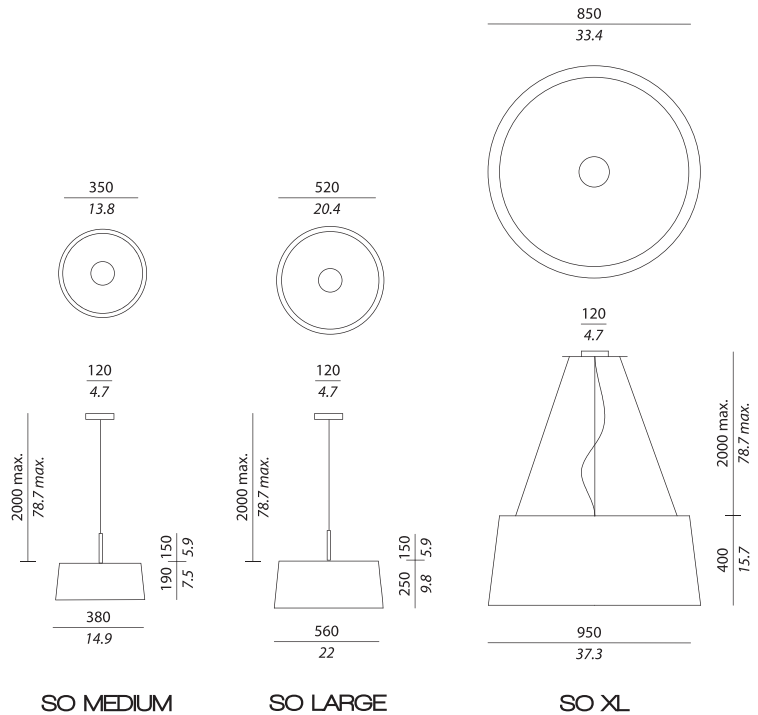





DIMINA SO XL:
Disco diffusore in cotone bianco /
White cotton diffuser disc



Finiture / Finishes

 Struttura cromo.
 Paralume plissettato color crema.
 Disco diffusore in plexiglass satinato.
*Chrome body.
Cream pleated shade.
Satin plexiglass diffuser disc.*

 Struttura cromo.
 Paralume plissettato color nero.
 Disco diffusore in plexiglass satinato.
*Chrome body.
Black pleated shade.
Satin plexiglass diffuser disc.*

 Struttura cromo.
 Paralume plissettato color bianco.
 Disco diffusore in plexiglass satinato.
*Chrome body.
White pleated shade.
Satin plexiglass diffuser disc.*

Fonte luminosa / Light source

CE _____

SO MEDIUM:
2 x E27 Halogen Energy Saving
42 W

SO LARGE:
2 x E27 Halogen Energy Saving
42 W

SO XL:
3 x E27 Halogen Energy Saving
70 W

Idoneo all'uso di lampadine
LED e fluorescenti compatte /
Suitable for LED or compact
fluorescent bulbs (CFL)

CE

USA _____

SO MEDIUM:
2 x E26 max 60 W

SO LARGE:
2 x E26 max 60 W

SO XL:
3 x E26 max 75 W

Suitable for LED or compact
fluorescent bulbs (CFL)

ETL
Intertek

LALA

Design by STÉPHANIE DU MESNIL GAILLARD



Lala Ap Soliflor



Lala Ap



LALA

informazioni tecniche / technical info

Specchio incassato nella base /
Bevelled mirror reflector in the base

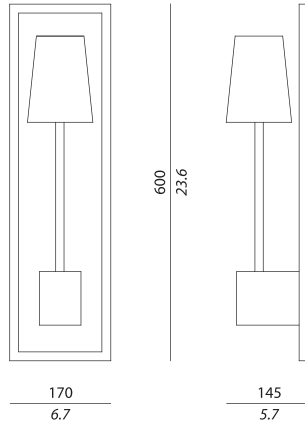

AP

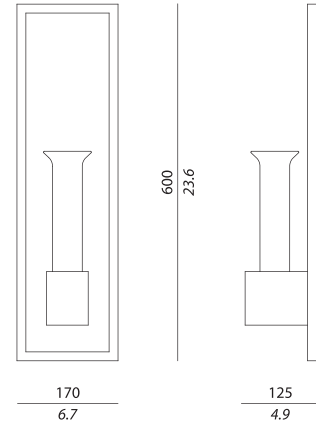

AP SOLIFLOR

Finiture / Finishes

AP

Base in rovere tinto wengè
con specchio incassato.
Stelo in nickel satinato.
Paralume cotone bianco.

Wengè wood base with
bevelled mirror reflector.
Satin nickel stem.
White cotton shade.

SOLIFLOR

Base in rovere tinto wengè
con specchio incassato.
Vaso in vetro trasparente.

Wengè wood base with
bevelled mirror reflector.
Clear glass vase.

Fonte luminosa / Light source

CE

AP:

1 x E14 Halogen energy saving
28 W

AP SOLIFLOR:

1 x custom LED
3 W , 250 Lm
2700 K , CRI: 90

Idoneo all'uso di lampadine
LED e fluorescenti compatte /
Suitable for LED or compact
fluorescent bulbs (CFL)

CE

USA

AP:

1 x E12 max 60 W

AP SOLIFLOR:

1 x custom LED
3 W , 250 Lm
2700 K , CRI: 90

Suitable for LED or compact
fluorescent bulbs (CFL)

ETL
Intertek

CIRCUS

Design by ALLTOGETHER



Circus Pl







Circus So



Vedi Circus Led nella sezione dedicata
"ARCHI-DECORATIVE" a pag 278

*See more of Circus Led in the
"ARCHI-DECORATIVE" section on page 278*

CIRCUS

informazioni tecniche / technical info

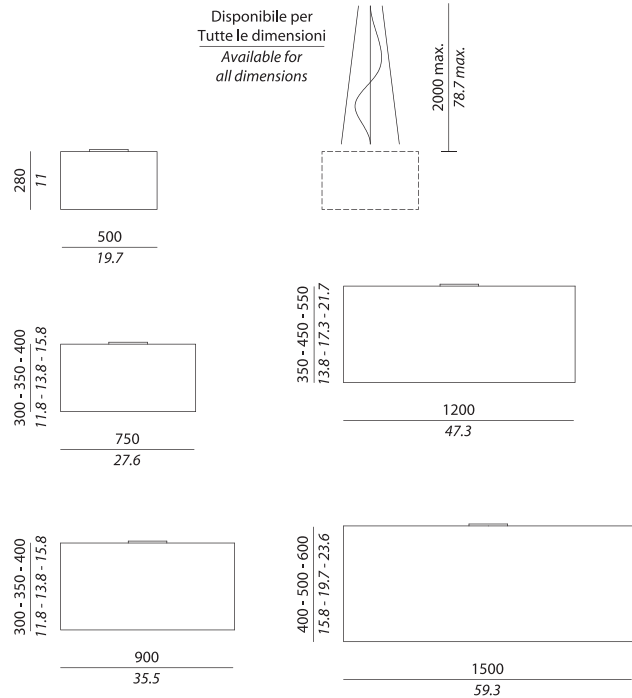

Finiture / Finishes

-  Paralume in cotone bianco o nero
White or black cotton shade.
-  Paralume in shantung grigio chiaro o bronzo.
Light grey or bronze shantung shade.
-  Paralume in dragnet colore grigio o bianco.
Grey or white dragnet shade
-  Paralume in Pebble o Estella
Pebble or Estella shade.
-  Paralume in shantung verde.
Green shantung shade.
-  Paralume in shantung avorio.
Ivory shantung shade.
-  Paralume in lino bianco.
White linen shade.
-  Passamaneria su richiesta.
Trim on demand.

Fonte luminosa / Light source

CE _____

SO / PL 50-75:
3 x E27 Halogen Energy Saving
70 W

SO / PL 90-120-150:
4 x E27 Halogen Energy Saving
105 W

Idoneo all'uso di lampadine
LED e fluorescenti compatte /
Suitable for LED or compact
fluorescent bulbs (CFL)

CE

USA _____

SO / PL 50-75:
3 x E26 max 100 W

SO / PL 90-120-150:
4 x E26 max 100 W

Suitable for LED or compact
fluorescent bulbs (CFL)

ETL
Intertek



TASK & READING

BEAM
UP
FLEXLED
MANHATTAN
DUOS
TATA
BELLE AP MINI

BEAM

Design by MARIA VAFIADIS



Beam Ta





Beam FI

BEAM

informazioni tecniche / technical info

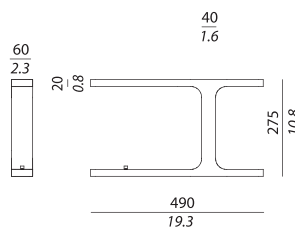

TA

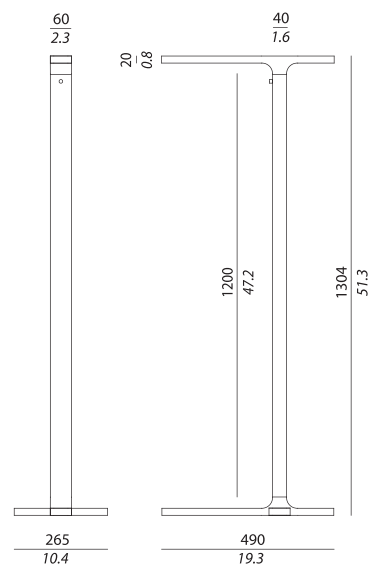

FL

Finiture / Finishes

Struttura bronzo spazzolato.
Satin bronze body.

TA:
Cavo in tessuto nero /
Black fabric cable
L: 300 + 2000 mm
11.8 + 78.7 inches

FL:
Cavo in tessuto nero /
Black fabric cable
L: 450 + 2000 mm
17.7 + 78.7 inches

Fonte luminosa / Light source

CE

TA: 2 x Strip LED 4 W (tot. 880 Lm)
2700 K , CRI: 90
Emission 180°

FL: 2 x Strip LED 4 W (tot. 880 Lm)
2700 K , CRI: 90
Emission 180°

CE

USA

TA: 2 x Strip LED 4 W (tot. 880 Lm)
3000 K , CRI: 90
Emission 180°

FL: 2 x Strip LED 4 W (tot. 880 Lm)
3000 K , CRI: 90
Emission 180°

Luce indirizzabile, tre posizioni:
sinistra, centrale e destra /
Orientable light, three positions:
left, central and right

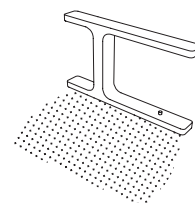
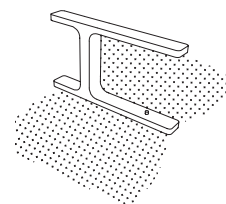
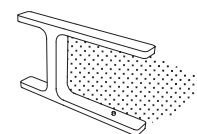

UP

Design by MASSIMILIANO RAGGI



Up Desk XL



Up FI



Up Desk



Up Ap

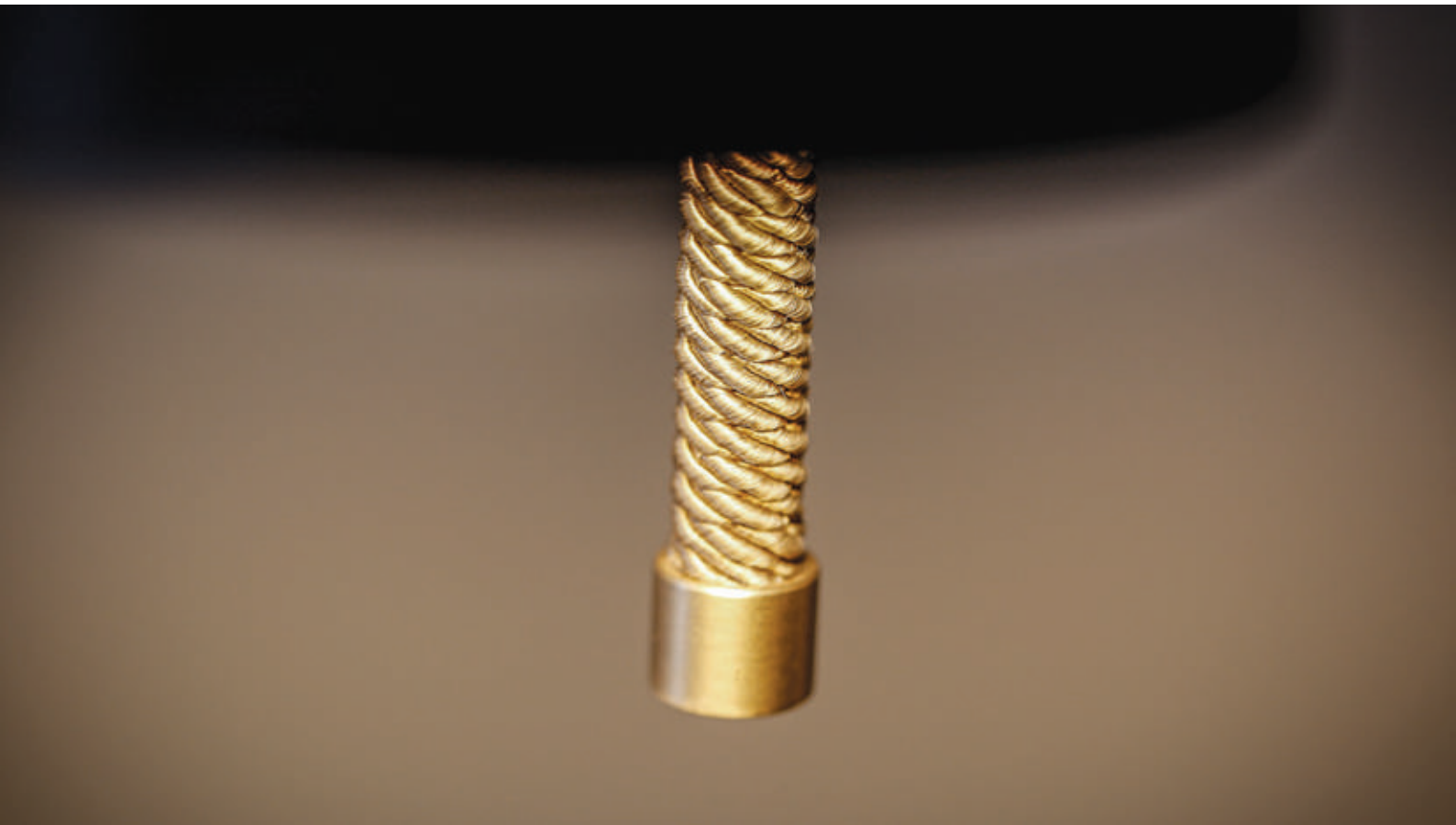

UP

informazioni tecniche / technical info

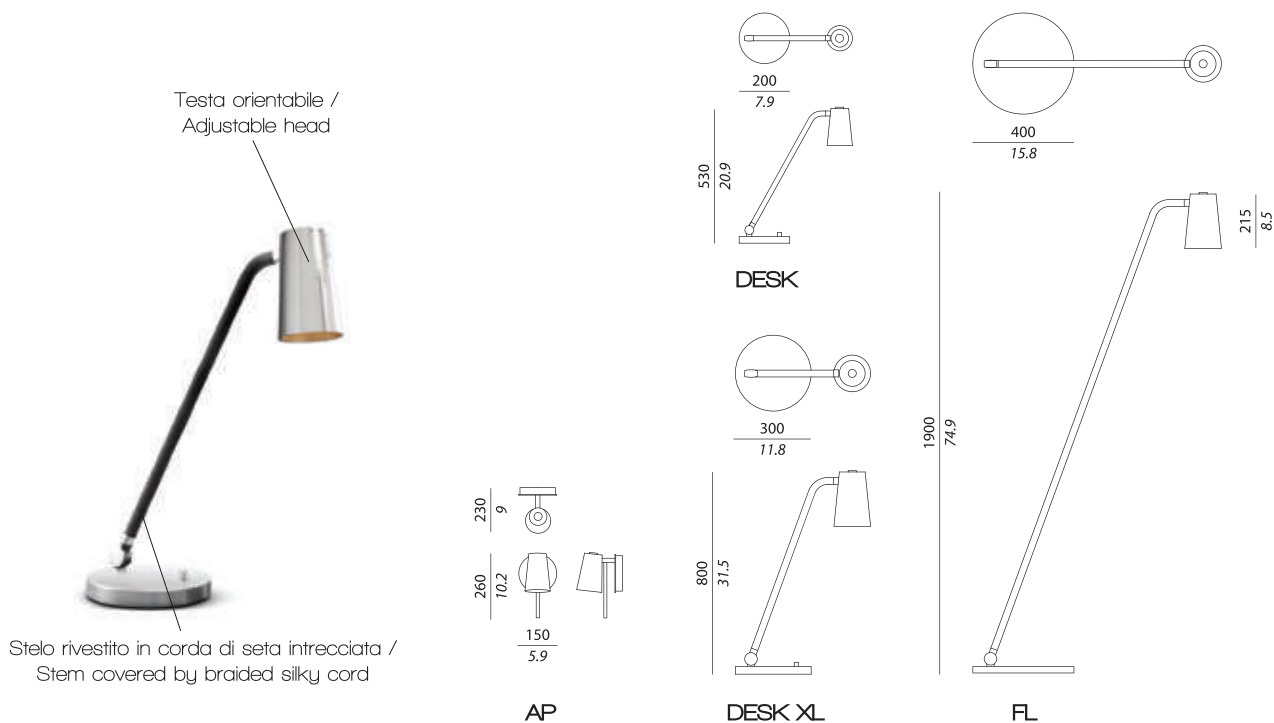

Finiture / Finishes

 Struttura cromo con dettagli in nickel nero lucido. Stelo rivestito in corda di seta intrecciata color grigio fumo. Diffusore cromo con interno oro.

Chrome body with polished black nickel details. Stem covered by braided silky cord, grey colour. Chrome diffuser with gold lining.

 Struttura bronzo spazzolato con dettagli in ottone satinato. Stelo rivestito in corda di seta intrecciata color miele. Diffusore bronzo spazzolato con interno oro.

Satin bronze body with satin brass details. Stem covered by braided silky cord, dark honey colour. Satin bronze diffuser with gold lining.

DESK:
Cavo in tessuto nero / *Black fabric cable*

L: 300 + 2000 mm
11.8 + 78.7 inches

DESK XL / FL:
Cavo in tessuto nero / *Black fabric cable*

L: 450 + 2000 mm
17.7 + 78.7 inches

Fonte luminosa / Light source

CE _____
AP:
1 x E27 LED 5 W

FL:
1 x E27 Compact Fluorescent
20 W

DESK:
1 x E27 LED 5 W

DESK XL:
1 x E27 Compact Fluorescent
20 W

Idoneo all'uso di lampadine LED /
Suitable for LED bulbs

CE

USA _____
AP:
1 x E26 max 60 W

FL:
1 x E26 Compact Fluorescent
11 W

DESK:
1 x E27 LED 5 W

DESK XL:
1 x E26 max 23 W

Idoneo all'uso di lampadine LED /
Suitable for LED bulbs

ETL
Intertek

FLEXILED

Design by KING & ROSELLI



Flexiled Ap (Steel)



Flexled Ap (Leather)



Flexiled FI

FLEXILED

informazioni tecniche / technical info

Altri colori disponibili su richiesta /
Other colours available on demand



Disponibile con o senza interruttore sulla base /
Available with or without switch on the base

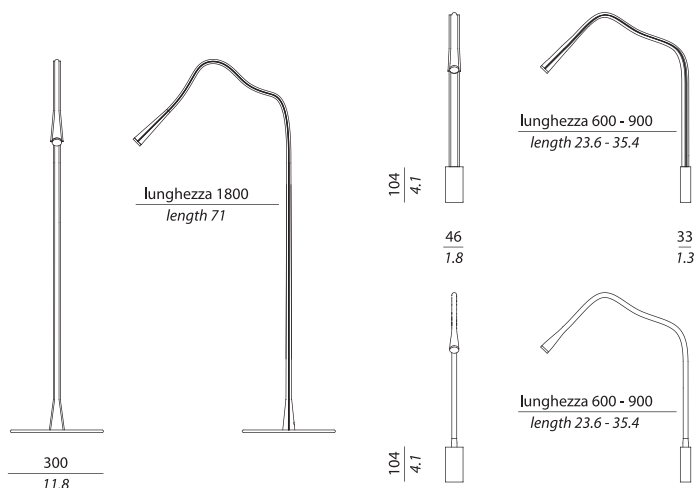

FL

AP

Finiture / Finishes

 Base nickel satinato o bronzo spazzolato.
Braccio in pelle marrone testa di moro.

 *Satin nickel or satin bronze base.*
Leather arm, dark brown colour.

 Base nickel satinato o bronzo spazzolato.
Braccio in pelle avorio.

 *Satin nickel or satin bronze base.*
Leather arm, ivory colour.

 Base nickel satinato o bronzo spazzolato.
Braccio in pelle nera.

 *Satin nickel or satin bronze base.*
Leather arm, black colour.

 Base nickel satinato.
Braccio maglia in acciaio intrecciato.

 *Satin nickel base.*
Braided steel mesh arm.

FL:
Cavo trasparente con interruttore On-Off /
Transparent cable with On-Off switch

L: 450 + 2000 mm
11.8 + 78.7 inches

Fonte luminosa / Light source

CE _____

AP:
1 x custom LED
3 W (tot. 500 Lm)
2700 K , CRI: 90

FL:
1 x custom LED
7 W (tot. 800 Lm)
2700 K , CRI: 90

CE

USA _____

AP:
1 x custom LED
3 W (tot. 500 Lm)
2700 K , CRI: 90

FL:
1 x custom LED
7 W (tot. 800 Lm)
2700 K , CRI: 90

 ETL
Intertek

MANHATTAN

Design by ALLTOGETHER



Manhattan Ap





MANHATTAN

informazioni tecniche / technical info

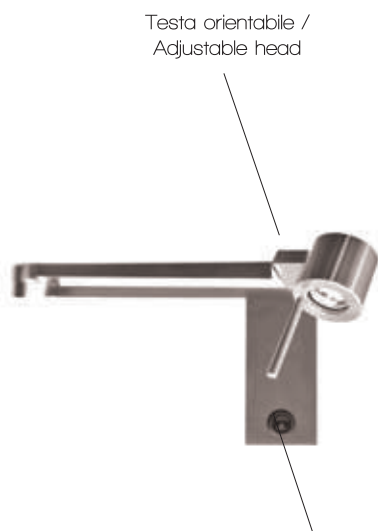

Testa orientabile /
Adjustable head

Disponibile con o senza interruttore sulla base /
Available with or without switch on the base

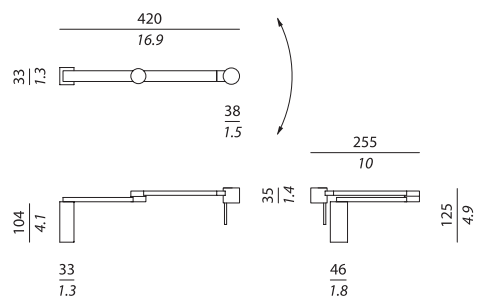

AP

Finiture / Finishes



Struttura bronzo spazzolato.
Satin bronze body.



Struttura nickel satinato.
Satin nickel body.

Fonte luminosa / Light source

CE

AP:
1 x custom LED
3 W (tot. 500 Lm)
2700 K , CRI: 90

USA

AP:
1 x custom LED
3 W (tot. 500 Lm)
2700 K , CRI: 90

CE



DUOS

Design by IZEU (TRISTAN AUER & FRÉDÉRIK SICARD)



Duos Ap





DUOS

informazioni tecniche / technical info

Cromo o bianco opaco con interno oro /
Chrome or matt white - gold lining

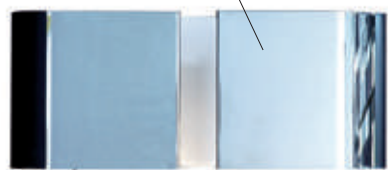

Luce orientabile per la lettura /
Adjustable light for reading

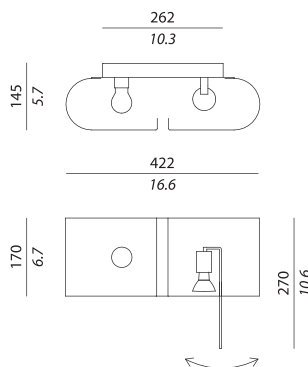

AP SX

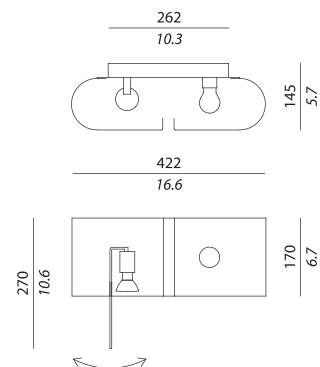

AP DX

Finiture / Finishes



Struttura cromo.
Chrome body.



Struttura bianco opaco con interno oro.
Matt white body with gold lining.

Fonte luminosa / Light source

CE _____
AP:
1 x GU10 Halogen Energy Saving
35 W
+
1 x E14 Halogen Energy Saving
42 W

USA _____

AP:
2 x E12 max 60 W

Idoneo all'uso di lampadine
LED e fluorescenti compatte /
*Suitable for LED or compact
fluorescent bulbs (CFL)*

*Suitable for LED or compact
fluorescent bulbs (CFL)*



TATA

Design by ANDREA FOGLI



Tata Ap



Tata FI







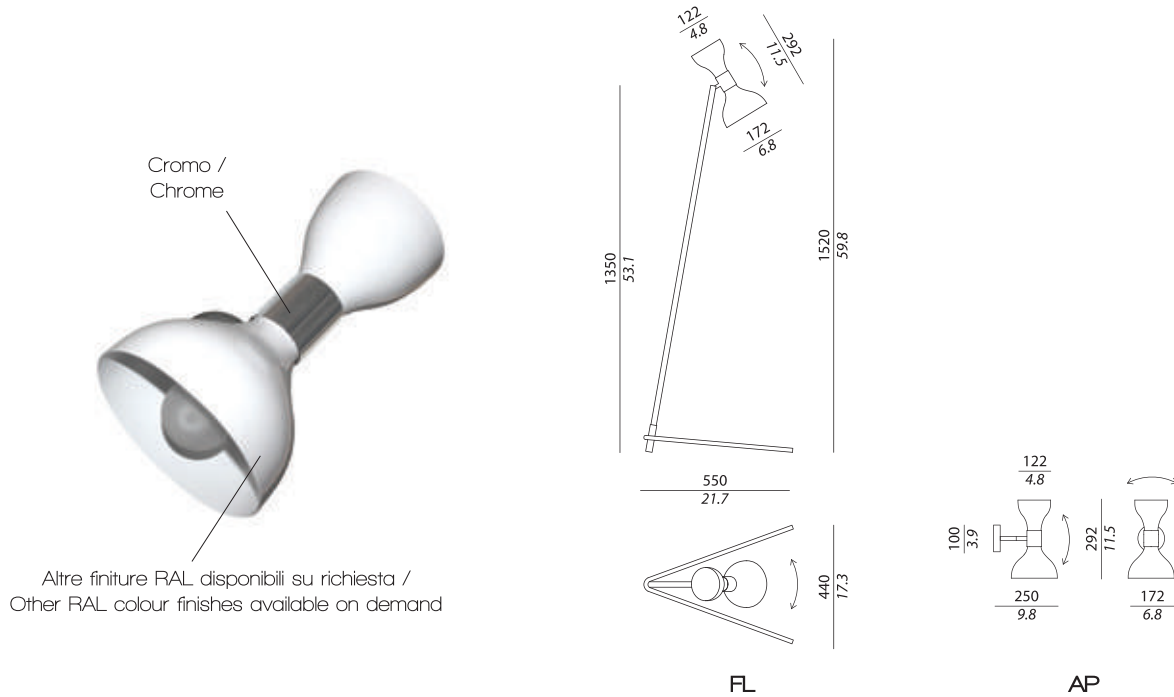

TATA

informazioni tecniche / technical info



Finiture / Finishes

- 
 Struttura cromo.
Riflettore nero opaco - interno bianco.
- 
 Chrome body.
Matt black - white internal reflector.
- 
 Struttura cromo.
Riflettore bianco lucido - interno bianco.
- 
 Chrome body.
Polished white - white internal reflector.
- 
 Struttura cromo.
Riflettore cromo - interno bianco.
- 
 Chrome body.
Chrome - white internal reflector.

FL:
Cavo in tessuto nero con interruttore On-Off /
Black fabric cable with On-Off switch

L: 450 + 2000 mm
11.8 + 78.7 inches

Fonte luminosa / Light source

CE _____

AP:
1 x E27 LED 5 W +
1 x E27 LED 11 W

FL:
1 x E27 LED 5 W +
1 x E27 LED 11 W

USA _____

AP:
2 x E26 max 11 W

FL:
2 x E26 max 11 W

Suitable for LED bulbs

CE



BELLE AP MINI

Design by STAFFAN TOLLGARD



Belle Ap Mini

Bronzo spazzolato o laccato bianco /
Satin bronze or white lacquered



Diffusore orientabile /
Adjustable diffuser

Vetro soffiato metallizzato bronzo o bianco lucido /
Polished bronze or polished white hand blown glass

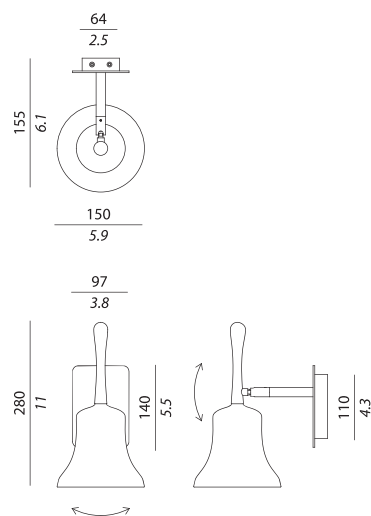

AP MINI

Finiture / Finishes



Struttura laccato bianco.
Diffusore in vetro soffiato bianco lucido.



White lacquered body.
Polished white hand blown glass diffuser.



Struttura bronzo spazzolato.
DELUXE: Diffusore metallizzato bronzo lucido.



Satin bronze body.
DELUXE: Polished bronze glass diffuser.

Fonte luminosa / Light source

CE _____

1 x Custom LED
4 W
(tot. >500 Lm)
2700 K , CRI: 90

USA _____

1 x Custom LED
4 W
(tot. >500 Lm)
2700 K , CRI: 90





ARCHI-DECORATIVE

SOLITARIO
RECESSED
CIRCUS LED

SOLITARIO

Design by MAURIZIO DI MAURO - MARCELLO COLLI





Solitario So



Solitario So (Spot light)

SOLTARIO so

componenti / components



Rosoni / Canopies



1X



3X



5X

Accessori / Accessories



Carrucola /
Pulley



Bloccacavo /
Cableclamp

Lenti / Lenses



Flood



Spot

Sfere / Spheres



Ø200 Fumé
Disponibili anche Ø120 /
Ø120 also available



Ø200 Flood
Disponibili anche Ø120 /
Ø120 also available



Ø120 Spot
Disponibili anche Ø200 /
Ø200 also available



Solitario PI

SOLTARIO so

esempi applicativi / installation examples

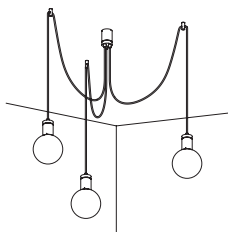

Composizione / Composition:

N° 3 SO
N° 1 rosone / canopy 3x
N° 3 kit accessori / accessories
(solo bloccacavo / cableclamp only)
N° 3 sfere / spheres Ø200

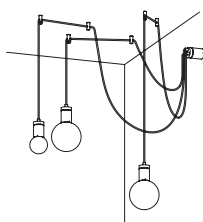

Composizione / Composition:

N° 3 SO
N° 1 rosone / canopy 3x
N° 3 kit accessori / accessories
N° 2 sfere / spheres Ø200
N° 1 sfera / sphere Ø120

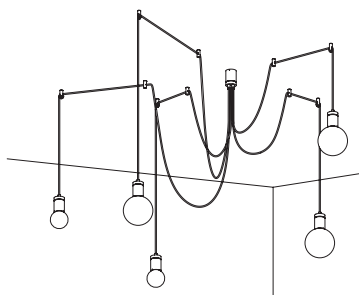

Composizione / Composition:

N° 5 SO
N° 1 rosone / canopy 5x
N° 5 kit accessori / accessories
N° 3 sfere / spheres Ø200
N° 2 sfere / spheres Ø120

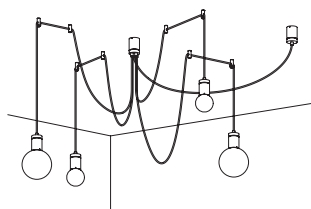

Composizione / Composition:

N° 4 SO
N° 1 rosone / canopy 1x
N° 1 rosone / canopy 5x
N° 4 kit accessori / accessories
N° 2 sfere / spheres Ø200
N° 2 sfere / spheres Ø120

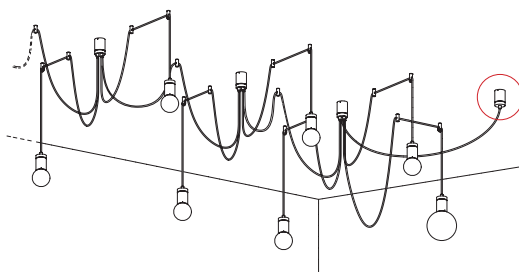

UNA SOLA USCITA ELETTRICA
PER COMPOSIZIONI POTENZIALMENTE INFINITE /
JUST ONE ELECTRICAL OUTPUT
FOR POTENTIALLY UNLIMITED COMPOSITIONS



Solitario Ap (Fumé light)



Solitario Ap Small (Flood light)

SOLTARIO

informazioni tecniche / technical info

Bronzo spazzolato chiaro
o nickel nero /
Light satin bronze
or black nickel



Diffusore in vetro soffiato metallizzato fumè chiaro o
parzialmente sabbato (effetto flood o effetto spot) /
Blown glass, light smoke finish or half frosted
(flood or spot effects)

Finiture / Finishes



Struttura nickel nero o
bronzo spazzolato chiaro.

Diffusore in vetro soffiato
metallizzato fumè.

*Light satin bronze or
black nickel body.
Blown glass light smoke finish.*



Struttura nickel nero o
bronzo spazzolato chiaro.
Diffusore parzialmente sabbato
(effetto flood o effetto spot).

*Light satin bronze or
black nickel body.
Blown glass half frosted
(flood or spot effects).*

Fonte luminosa / Light source

CE _____

SO:
1 x GU10 LED 8 W

PL:
1 x GU10 LED 8 W



USA _____

SO:
1 x GU10 LED 8 W

PL:
1 x GU10 LED 8 W

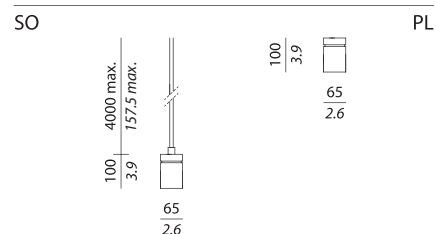

Rosoni / Canopy

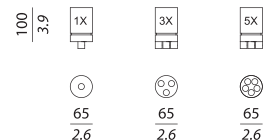

Sfere / Spheres

Smoke
Luce decorativa /
Decorative light

Flood
Luce diffusa /
Diffusing light

Spot
Luce puntiforme /
Spot light

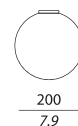

Lenti / Lens

Flood
Luce diffusa /
Diffusing light

Spot
Luce puntiforme /
Spot light



Accessori / Accessories

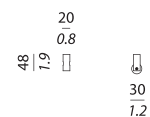

Diffusore in vetro soffiato metallizzato fumè chiaro o parzialmente sabbiato (effetto flood o effetto spot) /
Blown glass, light smoke finish or half frosted (flood or spot effects)



Bronzo spazzolato chiaro o nickel nero /
Light satin bronze or black nickel

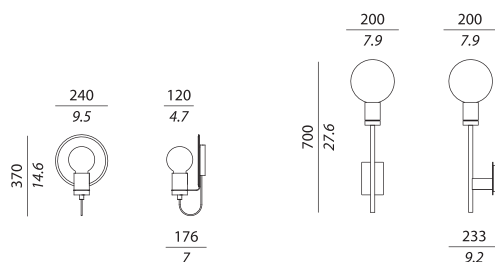

AP SMALL

AP

Finiture / Finishes



Struttura nickel nero o bronzo spazzolato.
Diffusore in vetro soffiato metallizzato fumé.



*Light satin bronze or black nickel body.
Blown glass light smoke finish.*



Struttura nickel nero o bronzo spazzolato.
Diffusore parzialmente sabbiato (effetto flood o effetto spot).



*Light satin bronze or black nickel body.
Blown glass half frosted (flood or spot effects).*

Fonte luminosa / Light source

CE _____

AP:
1 x GU10 LED 8 W

AP SMALL:
1 x GU10 LED 8 W

USA _____

AP:
1 x GU10 LED 8 W

AP SMALL:
1 x GU10 LED 8 W



RECESSED

Design by STAFFAN TOLLGARD



Recessed Square



Recessed Round



Recessed Plafone Round

RECESSED

informazioni tecniche / technical info



Mascherina rimovibile e personalizzabile /
Removable and interchangeable frontal screen

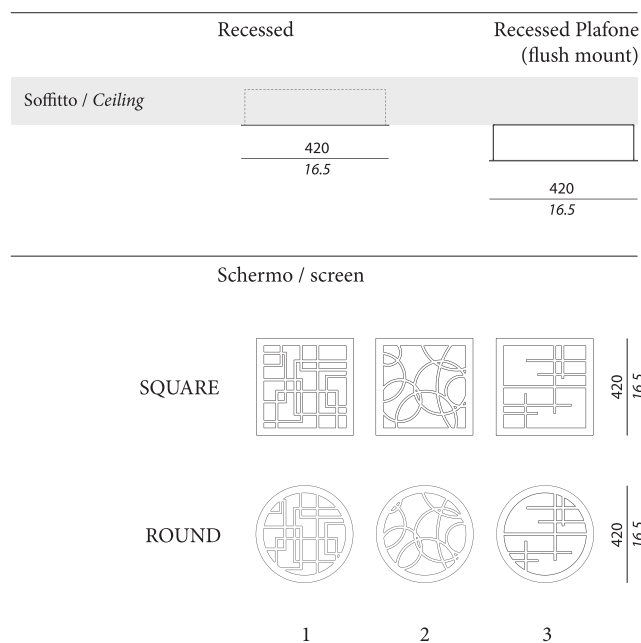

Finiture / Finishes

 Struttura bronzo spazzolato.
Diffusore plexiglass bianco.

 *Satin bronze body.*
White plexiglass diffuser.

Altre finiture su richiesta /
Other finishes on demand

Dimmerabile / Dimmable

Compatibili con sistemi
di controllo remoto.
(Verifica sul sito).

*Compatible with digital
control systems.*
(Check on website for more info).

Su richiesta disponibile con luce di
emergenza / Available on demand
with emergency light

Fonte luminosa / Light source

CE _____

Fluorescent:

ROUND or SQUARE:
1 x T5 Compact Fluorescent
55 W
4200 Lm

Led:

ROUND:
1 x Custom LED 30 W
(tot. 4000 Lm)
3000 K , CRI: >80

SQUARE:
1 x Custom LED 40 W
(tot. 5000 Lm)
3000 K , CRI: >80

CE

USA _____

Available the "plafone" version
(Flush Mount) only.

See CE section aside
for lamping.

CIRCUS LED

Design by ALLTOGETHER



Circus LED

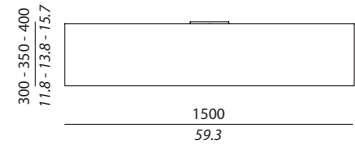
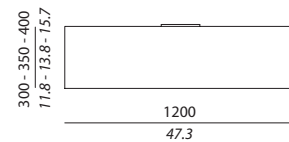
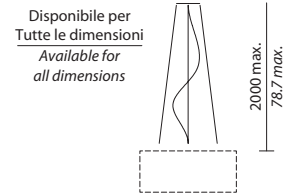
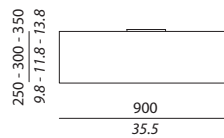
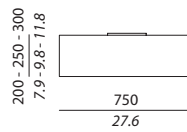
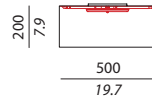

Finiture / Finishes

-  Paralume in cotone bianco o nero
White or black cotton shade.
-  Paralume in shantung grigio chiaro o bronzo.
Light grey or bronze shantung shade.
-  Paralume in dragnet colore grigio o bianco.
Grey or white dragnet shade
-  Paralume in Pebble o Estella
Pebble or Estella shade.
-  Paralume in shantung verde.
Green shantung shade.
-  Paralume in shantung avorio.
Ivory shantung shade.
-  Paralume in lino bianco.
White linen shade.
-  Passamaneria su richiesta.
Trim on demand.

Fonte luminosa / Light source

CE _____

SO/PL 50-75:
1 x Custom LED Board 53 W
7300 Lm , 3000 K , CRI: 90

SO/PL 90-120-150:
1 x Custom LED Board 70 W
10000 Lm , 3000 K , CRI: 90

Dimmerabile / Dimmable

Compatibili con sistemi di controllo remoto. (Consultare il sito).

Compatible with digital control systems. (Check on website for more info).

CE

USA _____

SO/PL 50-75:
1 x LED Board 53 W
7300 Lm , 3000 K , CRI: 90

SO/PL 90-120-150:
1 x LED Board 70 W
10000 Lm , 3000 K , CRI: 90

Dimmable

Compatible with digital control systems. (Check on website for more info).





OUTDOOR

CALYPSO (OUTDOOR)
MUSE LANTERN (OUTDOOR)
MUSE (OUTDOOR)
FREEDOM
COCO MEGA (OUTDOOR)
XXL (OUTDOOR)

CALYPSO OUTDOOR

Design by SERVOMUTO





Calypso Outdoor (Antigua - Guadeloupe - Martinique)

CALYPSO

OUTDOOR IP65

informazioni tecniche / technical info

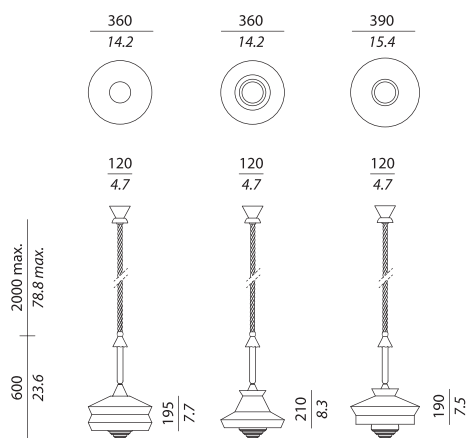

Finiture / Finishes

Struttura ottone spazzolato.
Diffusore in vetro trasparente.

Satin brass body.
Transparent glass diffuser.

Corda intrecciata in tessuto impermeabile color verde muschio /
Moss green braided waterproof fabric cord

L: max 2000 mm
max 78.7 inch



ANTIGUA

MARTINIQUE

Paralumi / Shades

ANTIGUA:

Black
Mint
Sale e Pepe
White

MARTINIQUE:

Black
Yellow
Building
White

GUADALOUPE:

Black
Mint
Sale e Pepe
White

Fonte luminosa / Light source

CE

1 x E27 LED 8 W

CE

USA

1 x E27 LED 8 W



GUADALOUPE



MUSE LANTERN OUTDOOR

Design by TRISTAN AUER



Muse Lantern Battery Outdoor



Muse Lantern Outdoor



Muse Lantern So Outdoor

MUSE LANTERN

OUTDOOR IP65

informazioni tecniche / technical info

Maniglia in pelle intrecciata marrone /
Brown leather handle



Sagoma illuminata a forma di lampadina /
Illuminated bulb-like shape

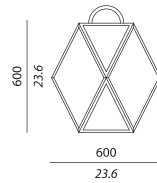

TA LARGE

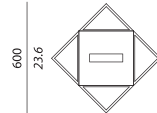

TA MEDIUM

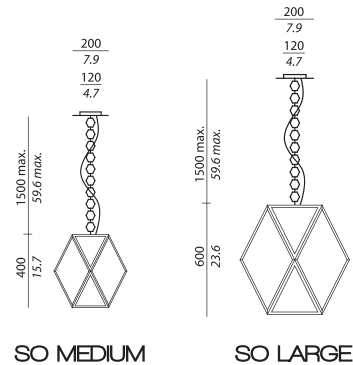
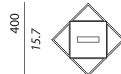
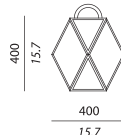

SO MEDIUM

SO LARGE

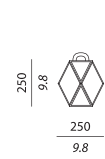

BATTERY SMALL

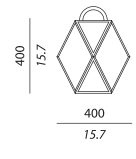

BATTERY MEDIUM

Finiture / Finishes

- Struttura laccata effetto bronzo (per uso esterno).
 - Diffusore acrilico color ambra.
- Lacquered frame, bronze effect (for outdoor use).*
Amber acrylic diffuser.

TA:
Cavo nero con connettore IP65 /
Black cable with IP65 connector

L: 2000 mm
78.7 inches

Batteria con autonomia di circa 8 ore /
Battery autonomy: 8 hours

Fonte luminosa / Light source

CE _____

TA:
1 x E27 LED 8 W

TA BATTERY:
1 x custom LED 3 W
(tot. 450 Lm)
3000 K , CRI: 90

SO:
1 x E27 LED 8 W

USA _____

TA:
1 x E27 LED 8 W

TA BATTERY:
1 x custom LED 3 W
(tot. 450 Lm)
3000 K , CRI: 90

SO:
1 x E27 LED 8 W

Idoneo all'uso di lampadine LED /
Suitable for LED bulbs

Suitable for LED bulbs

CE

MUSE OUTDOOR

Design by TRISTAN AUER



Muse Outdoor



Muse FI Outdoor



Muse Ta Battery Outdoor (Small & Medium)



Muse So Outdoor (Large)



MUSE

OUTDOOR IP65

informazioni tecniche / technical info

Maniglia in pelle intrecciata nera o bianca /
Braided leather handle, black or white colour



Diffusore acrilico satinato /
Satin acrylic diffuser

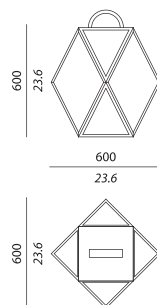
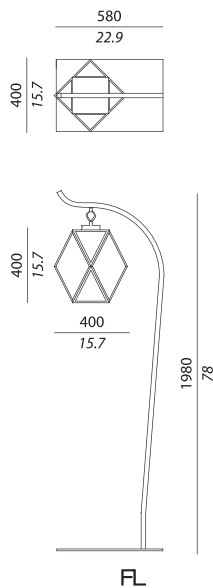

TA LARGE

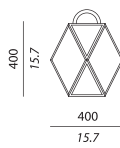

TA MEDIUM

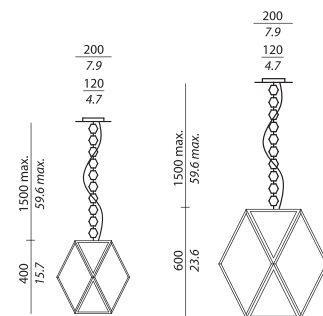

SO MEDIUM

SO LARGE

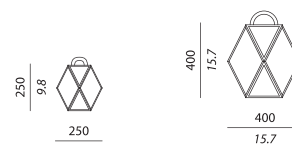

BATTERY SMALL

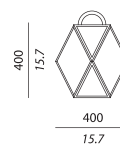

BATTERY MEDIUM

Finiture / Finishes

 Struttura verniciata nera.
Diffusore acrilico satinato.

 *Black lacquered frame.*
Satin acrylic diffuser.

 Struttura verniciata bianco perla.
Diffusore acrilico satinato.

 *White pearl lacquered frame.*
Satin acrylic diffuser.

TA:
Cavo nero con connettore IP65 /
Black cable with IP65 connector

L: 2000 mm
78.7 inches

FL:
Cavo nero con connettore IP65 /
Black cable with IP65 connector

L: 3000 mm
118.1 inches

Fonte luminosa / Light source

CE _____

TA:
1 x E27 Compact Fluorescent
23 W

TA BATTERY:
1 x LED custom 3 W
(tot. 500 Lm)
3000 K , CRI: 90

FL:
1 x E27 Compact Fluorescent
23 W

SO:
1 x E27 Compact Fluorescent
23 W

*Idoneo all'uso di lampadine LED /
Suitable for LED bulbs*

CE

USA _____

TA:
1 x E26 Compact Fluorescent
23 W

TA BATTERY:
1 x LED custom 3 W
(tot. 500 Lm)
3000 K , CRI: 90

FL:
1 x E26 Compact Fluorescent
23 W

SO:
1 x E26 Compact Fluorescent
23 W

Suitable for LED bulbs

 Intertek

FREEDOM

Design by MASSIMILIANO RAGGI



Freedom



Freedom with ground plate

FREEDOM

IP65

informazioni tecniche / technical info

Gabbia verniciata bronzo /
Bronze lacquered cage



Legno marino marrone scuro /
Dark brown marine wood

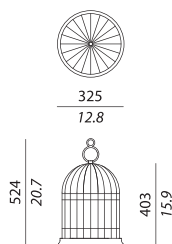

FL

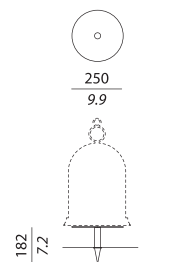
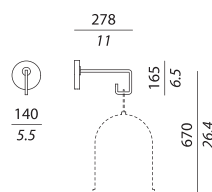
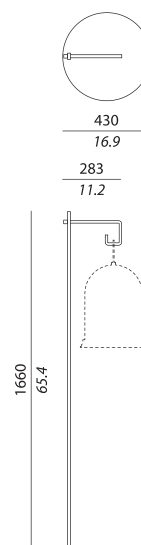

Plate for ground



Hook for wall



Hook for floor

Finiture / Finishes

- Base in legno marrone scuro.
Gabbia bronzo verniciato.
- Diffusore in vetro resina color crema.
Dark brown marine wood base.
Bronze lacquered cage.
Fiberglass diffuser, cream colour.

Cavo nero con connettore IP65 /
Black cable with IP65 connector

L: 2000 mm
78.7 inches

Batteria con autonomia di circa 8 ore /
Battery autonomy: 8 hours

Fonte luminosa / Light source

CE _____

FL:
1 x E27 Compact Fluorescent
23 W

BATTERY version:
1 x LED custom 3 W
(tot. 500 Lm)
3000 K , CRI: 90

Idoneo all'uso di lampadine LED /
Suitable for LED bulbs

CE

USA _____

FL:
1 x E26 Compact Fluorescent
23 W

BATTERY version:
1 x LED custom 3 W
(tot. 500 Lm)
3000 K , CRI: 90

Suitable for LED bulbs

Hook for wall



Plate for ground

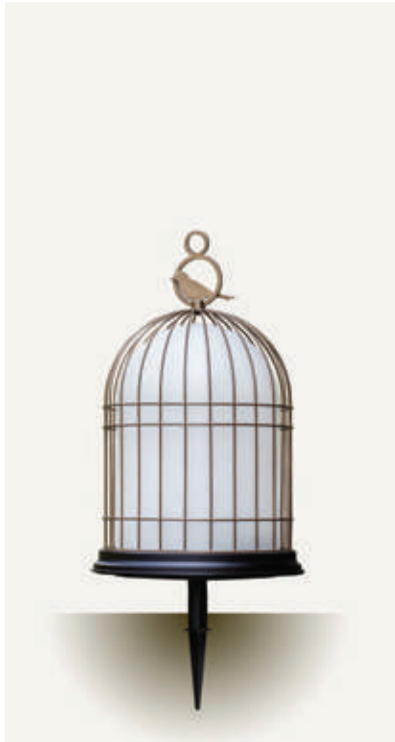

Hook for floor



Accessori in metallo laccato nero per estendere le possibilità d'uso della lampada FREEDOM /
Black lacquered accessories to extend the possibility of using the FREEDOM lamp.



COCO MEGA OUTDOOR

Design by TRISTAN AUER



Coco Mega Outdoor





COCO MEGA

OUTDOOR IP65

informazioni tecniche / technical info

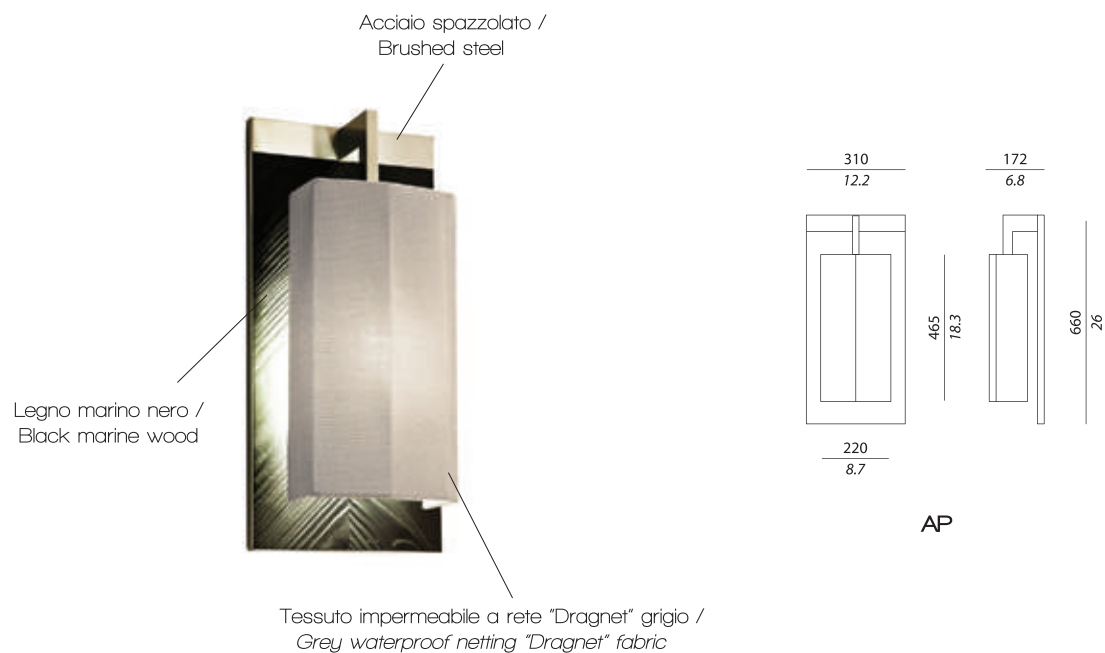

Finiture / Finishes

Struttura in acciaio spazzolato e legno marino nero con trattamento impermeabilizzante. Paralume in tessuto impermeabile a rete "Dragnet" color grigio.

Body in brushed steel and black waterproof marine wood. Shade in grey waterproof netting "Dragnet" fabric.

Fonte luminosa / Light source

CE _____

AP:
1 x E27 Compact Fluorescent
23 W

USA _____

AP:
1 x E26 Compact Fluorescent
23 W

Idoneo all'uso di lampadine LED /
Suitable for LED bulbs

Suitable for LED bulbs

CE

ETL
Intertek

XXL OUTDOOR

Design by GIANLUIGI LANDONI







XXL OUTDOOR IP65

informazioni tecniche / technical info

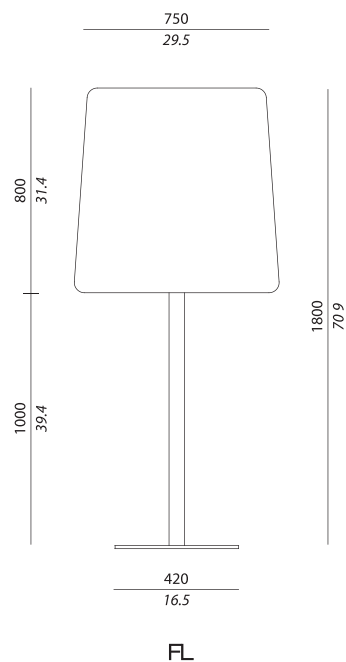

Finiture / Finishes

- Struttura laccata avorio.
Diffusore in vetroresina, color crema.
- Ivory lacquered metal.
Diffuser in fiberglass, cream colour.

Cavo nero con connettore IP65 /
Black cable with IP65 connector

L: 600 + 2000 mm
23.6 + 78.7 inches

Fonte luminosa / Light source

CE _____

FL:
4 x E27 Compact Fluorescent
23 W

USA _____

FL:
4 x E27 Compact Fluorescent
23 W

Idoneo all'uso di lampadine LED /
Suitable for LED bulbs

Suitable for LED bulbs

CE



ONGO

ONGO

ONGO

Design by JESSICA CORR for TZELAN





ONGO

informazioni tecniche / technical info

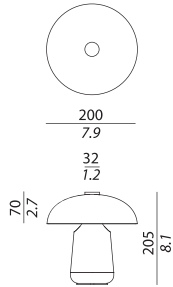

Batteria con autonomia di circa 6 ore /
Battery autonomy: 6 hours

Fonte luminosa / Light source

CE _____

1 x Custom LED 2 W
2800 K , CRI: 90

High brightness : 145 Lm
Low brightness : 110 Lm



USA _____

1 x Custom LED 2 W
2800 K , CRI: 90

High brightness : 145 Lm
Low brightness : 110 Lm



Finiture / Finishes



Struttura nickel lucido
Diffusore nickel lucido
*Polished nickel body
Polished nickel diffuser*



Struttura nickel lucido
Diffusore vetro nero con interno oro
*Polished nickel body
Black blown glass with gold lining diffuser*



Struttura nickel lucido
Diffusore vetro soffiato bianco lucido
*Polished nickel body
White blown glass diffuser*



Struttura oro rosa
Diffusore oro rosa
*Rose gold body
Rose gold diffuser*



Struttura oro rosa
Diffusore vetro nero con interno oro
*Rose gold body
Black blown glass with gold lining diffuser*



Struttura oro rosa
Diffusore vetro soffiato bianco lucido
*Rose gold body
White blown glass diffuser*



Struttura bronzo spazzolato chiaro
Diffusore bronzo spazzolato chiaro
*Light satin bronze body
Light satin bronze diffuser*



Struttura bronzo spazzolato chiaro
Diffusore vetro nero con interno oro
*Light satin bronze body
Black blown glass with gold lining diffuser*



Struttura bronzo spazzolato chiaro
Diffusore vetro soffiato bianco lucido
*Light satin bronze body
White blown glass diffuser*

Charging Trolley **Ongo**

*Custom trolley to recharge 16 Ongo at the same time.
Other version available upon request.*

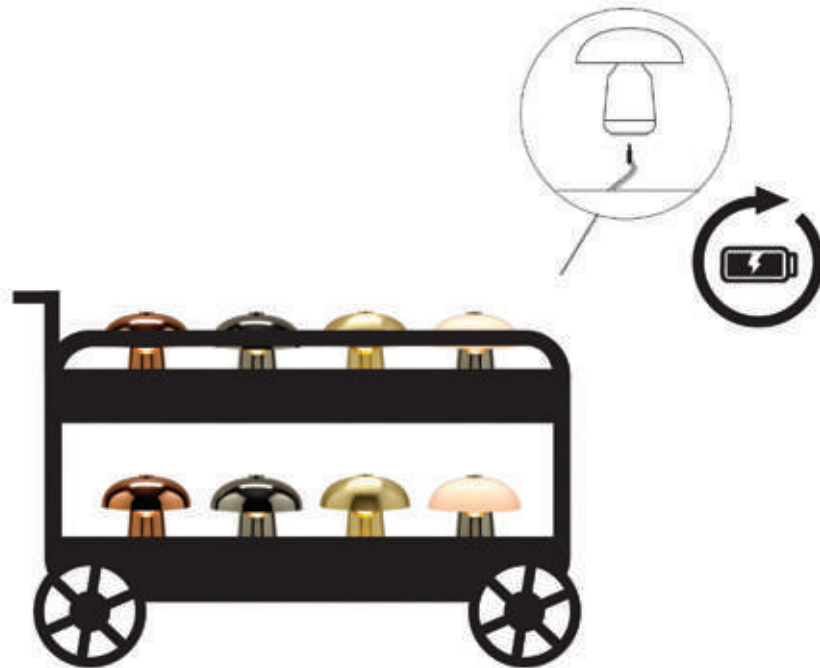



CONTRACT DIVISION

OUR WAY TO DO CONTRACT

"OUR WAY TO DO CONTRACT"



Da oltre 30 anni Contardi produce lampade decorative di qualità per il mercato alberghiero.

Oltre alla collezione standard, rappresentata oggi da una vasta gamma di modelli, la Divisione Contract offre uno specifico **"servizio su misura"**, volto a rispondere alle esigenze del mercato "contract" con una larghissima varietà di soluzioni.

Kempinski Grand Hotel, Hilton Group, Mandarin Oriental, Hyatt, Starwoods sono solo alcune delle catene alberghiere internazionali che Contardi fornisce.

Il team della Divisione Contract vanta una lunga esperienza nelle tecniche di lavorazione di vari materiali tra i quali il metallo, il vetro, il tessuto, la ceramica, il marmo ed il legno. Opera senza porre limiti in base allo stile e sulla base di una vasta conoscenza degli standard di sicurezza di tutti i mercati.

Recentemente è stato lanciato il programma denominato **"Our way to do contract – il nostro modo di fare contract"** che non è soltanto uno slogan ma un vero e proprio approccio alle richieste ed esigenze del mercato dell'Hotel e del mondo delle specifiche (FF&E).

Contardi, attraverso la propria Divisione Contract, ha deciso di rispondere alla ormai comune richiesta di rispettare dei "budget" definiti offrendo delle soluzioni alternative, o semplicemente "più economiche", senza però ridurre gli standard qualitativi e di servizio, confermando la garanzia di un prodotto *made in Contardi e made in Italy*.

È possibile scaricare il catalogo dedicato al Contract dal sito: www.contardi-italia.com/it_contract.

For more than 30 years Contardi has been manufacturing high quality decorative lights for the hotel industry.

*Besides the standard collection, now offering a wide range of models, Contardi's contract division offers a **"bespoke design service"**, working on clients' project requirements, where the possibilities are almost endless.*

Kempinski Grand Hotel, Hilton Group, Mandarin Oriental, Hyatt, Starwoods are only some of the international hotel chains Contardi supplies.

Contardi's contract team has a long experience in working with materials, from metal to glass, from fabrics to marble, as well as ceramics or wood. No limitations on style and a strong knowledge of safety standards for all markets.

*Recently we have launched the program **"Our way to do contract"**, which is not just a slogan but a commercial approach to the specific requirement of hospitality industry and the FF&E world.*

Contardi's contract division has decided to respond to the growing needs to stick to fixed budgets by offering an alternative solution (that we call V.E – Value Engineered – version of Contardi's specified products or custom ones) without compromising with quality and service and still providing, instead of a cheap copy, the guarantee of an original made in Italy product.

You can download the Contract catalogue from our website: www.contardi-italia.com/en_contract.



Hogan Lovells, Denver, CO
Jake Holschuh Photographer



CREDITS

Dedicated to
MICHELE CARCANO.

WORKS

Art Direction: Massimiliano Raggi Architetto

Artworks: Studio Massimiliano Raggi

PHOTOS

Paolo Crocenzi

Lorenzo Pennati

SPECIAL THANKS TO:

Massimiliano Raggi

Gabriele Galli

Alice Sola

Sara Ostini

Giorgio Dalle Nogare

Inkiostro Bianco

Casa Casati

On House Milano

Minotti Spa

Meroni&Colzani

Misura Arredamenti

Olivieri

Turin Palace Hotel

Grand Hotel Kempinski

Severin*s – The Alpine Retreat

Hotel Du Midi

Staffan Tollgard

Myself





Headquarters ITALIA

CONTARDI LIGHTING srl

Via Manzoni 134/140 - 20811 Cesano Maderno (MB)

Ph. +39 0362 301381 - sales@contardi-italia.it

www.contardi-italia.com

USA Branch

CONTARDI USA, Inc

59 Pearl Street, Unit 21 - 11201 Brooklyn NY

Ph. +1 718-715-0717 - sales@contardi-usa.com

www.contardi-usa.com