

Daum

FRANCE 1878

CATALOGUE GÉNÉRAL
GENERAL CATALOGUE



Daum

FRANCE 1878



Histoire *History*

Daum, depuis 1878

Daum, maître-verrier légendaire, entretient depuis plus d'un siècle une relation d'amour avec les plus grands artistes de son temps, offrant à leurs oeuvres une seconde vie de cristal et de couleurs. De l'Ecole de Nancy, de l'Art Nouveau aux Arts Décoratifs, de Majorelle à Dali, Arman et Hilton McConnico, Daum n'a manqué aucun des rendez-vous magiques de la création artistique et du savoir-faire moderne, ce mariage toujours renouvelé de l'art et de l'artisanat. Peu de marques auront travaillé avec autant d'artistes : en presque 140 ans, plus de 350 signatures d'exception constituent un patrimoine incomparable, une collection unique en son genre. Comment traduire ces oeuvres en sculptures de cristal ? Là est tout le secret de Daum, manufacturier de l'exception, atelier très savant, laboratoire des merveilles, couturier d'objets sans pareils.

Daum, since 1878

Daum, the legendary glassmaker master, has kept alive for more than a century a love relationship with the greatest artists of its time, giving their work of art a second life of crystal and colours. From the Ecole de Nancy, from Art Nouveau to Art Decoratif, from Majorelle to Dali, Arman and Hilton McConnico, Daum has not missed any of the magic rendez-vous of the artistic creation and modern savoir-faire, which has always renewed the alliance of art and art craft. Few brands have worked with as many artists: for nearly 140 years, more than 350 exceptional signatures have constituted a heritage beyond compare, a unique collection. How to convey those works into crystal sculptures? This is where Daum's secret lies, shaper of the exception, highly knowledgeable workshop, laboratory of wonders, designer of incomparable objects.



Création de la verrerie Daum à Nancy par Jean Daum.

Creation of Daum glassworks in Nancy by Jean Daum.

1878

Création du premier département d'art au sein de la manufacture par Antonin Daum, fils de Jean. Les premiers vases ornés de fleurs colorées finement ciselées apparaissent, préfigurant le style « Art Nouveau ».

Creation of the first art department of the manufacturer by Antonin Daum, son of Jean Daum. The first vases adorned with finely chiselled coloured vases appear, giving way to the Art Nouveau artistic trend.



1891

Grand prix décerné à Daum lors de l'Exposition Universelle de Paris. Création de l'École de Nancy avec Emile Gallé. Arrivée d'Amalric Walter et introduction de la technique de pâte de verre chez Daum (1904). Les frères Daum habillent la lumière de verre, création de la première lampe « Champignon » (1910).

Daum is awarded the Grand Prize at the Universal Exposition in Paris. Creation of the "Ecole de Nancy" with Emile Gallé. Amalric Walter arrives and the "pâte de verre" technique is introduced at Daum (1904). The Daum brothers dress light with glass and create the first lamp in a shape of a mushroom, "the Lamp Champignon" (1910).



ANNÉES 1900

Nouvelle esthétique sous l'impulsion de Paul Daum, petit-fils de Jean Daum. Les premières pièces de style « Art deco » apparaissent avec des lignes droites, géométriques et le développement de nouvelles couleurs.

New aesthetic appears under the lead of Paul Daum, grandson of Jean Daum. The first "Art Deco" styled pieces are presented with straight, geometric lines and new colours are developed.



ANNÉES 1920

Intégration du cristal dans la fabrication Daum, première commande de plusieurs services de table pour le paquebot Normandie.

Crystal is integrated in the manufacturing of Daum. The first order of dinner services for the Normandy liner is placed.



ANNÉES 1930

Remplacement définitif du verre par le cristal, lancement d'un nouveau style de création « les formes libres ».

Glass is permanently replaced by crystal. A new style of creation, "free forms" is launched.



ANNÉES 1940

Introduction d'un nouveau savoir-faire avec les techniques de la pâte de cristal et de la cire perdue. La Cristallerie décide d'orienter ses créations autour de l'art et du design en signant des collaborations avec les plus grands noms de l'époque de Salvador Dalí (1968) à César (1969) en passant par Roger Tallon (1967).

A new savoir-faire is introduced with the "pâte de cristal" and lost-wax technique. The crystal glassworks decides to orient its creations around art and design by collaborating with the greatest names of the time, from Salvador Dalí (1968) to Roger Tallon (1967) and César (1969).



ANNÉES 1960

La Manufacture confirme son empreinte dans le milieu de l'art et du design et signe des collaborations iconiques avec les designers Hilton McCornico (1986), Christophe Pillet (1999) et avec l'artiste Arman (1997).

The Manufacturer confirms its mark in the centre of art and design with its iconic collaborations with designers Hilton McCornico (1986), Christophe Pillet (1999) and the artist Arman (1997).



ANNÉES 1980-90



Christian J. J. / Philippe Richard

EPV
Entreprise
du Patrimoine
Vivant

Cette période est marquée par de longues collaborations avec des artistes comme Jean-Philippe Richard, dont Daum promulgue le talent, mais aussi de nombreux designers, comme Jean-Marie Mossaud et Christian Ghion notamment avec l'exposition « 12+1 » ou encore des artistes confirmés comme Richard Texier (2008) ou Jérôme Mesnager (2009). Daum obtient la labélisation Entreprise du Patrimoine Vivant, EPV (2007).

This period is not only marked with long collaborations with artists such as Jean-Philippe Richard, where Daum promulgates talent, but also with many designers, like Jean-Marie Mossaud and Christian Ghion through the exhibition "12+1", or even established artists such as Richard Texier (2008) or Jérôme Mesnager (2009). Daum receives the "Entreprise du Patrimoine Vivant" EPV Label (2007).

ANNÉES 2000

La Manufacture continue d'écrire son histoire dans l'univers de l'art et du design en signant des collaborations avec des artistes contemporains d'univers variés comme Villéglé (2011), Madeleine van der Knoop (2013), Kongo (2016), Laurence Bannel (2017) ou encore Kriki (2017). L'exposition au Musée Dali, « Daum variation d'artistes » (2015) met à l'honneur ce mariage entre Daum et les Artistes. La Manufacture repousse encore les limites de son art en créant un univers d'architecture d'intérieur (2011) et de bijoux (2017) déclinant ainsi le cristal sous toutes ses formes.

The Manufacturer continues to write its story in the universe of art and design by collaborating with contemporary artists of varied universes such as Villéglé (2011), Madeleine van der Knoop (2013), Kongo (2016), Laurence Bannel (2017), and Kriki (2017) to name a few. The exhibition held at the Dali Museum, "Daum Variation of Artists" (2015) honours this marriage between Daum and the artists. The Manufacturer pushes its limits by creating an interior design and jewellery (2017) universe, thus declining the crystal in all its forms.



© Daum / Kriki

ANNÉES 2010

La Cristallerie marque son empreinte dans l'avenir de ses métiers en créant le laboratoire LOVV avec le CERFAV (laboratoire de recherche sur les normes écologique).

The Maison Daum invests in its future by creating the LOVV laboratory with CERFAV (research laboratory on ecological standards).

LOVV

2016



© Daum / Laurence Bannel

2018

140 ans de création, Daum continue d'écrire son histoire...

With 140 years of creation, Daum continues to write its history...



UN SAVOIR-FAIRE D'EXCEPTION
DEPUIS 1878





Savoir-Faire *Know How*

Daum, un savoir-faire unique

Comment obtenir ces effets moirés, cette matière translucide minérale ou givrée, ces harmonies subtiles propres aux objets en pâte de cristal de Daum ? Secrets d'un processus de création entièrement artisanal, transmis de génération en génération. Si la technique de la pâte de verre existe depuis l'Antiquité, Daum la redécouvre en 1968 en la retravaillant avec du cristal. Ce savoir-faire unique est encore aujourd'hui opéré par les meilleurs maîtres-verriers. Par un procédé de fonderie et de moulage à la cire perdue, cette technique artisanale assure un rendu de matière très particulier, impossible à obtenir avec une technique traditionnelle de cristal soufflé. Une palette exceptionnelle de 40 nuances permet d'obtenir des effets de couleur uniques.

Daum's unique know-how

How does Daum obtain those moiré effects, that translucent mineral or frosted finish and those subtle harmonies peculiar to its "pâte de cristal"? These are the secrets of a traditional creative process, handed down from generation to generation. Although the pâte de verre technique has existed since Antiquity, Daum rediscovered it in 1968 when it invented a method of reworking it using crystal. This unique know-how is still employed today by the best master glassmakers. Casting a piece using this lost-wax process ensures the perfect regularity of its contours, which would be impossible to obtain using traditional crystal or glassblowing methods, as well as an instantly recognizable, grainy appearance.

Tous nos produits sont fait en France
All our pieces are made in France

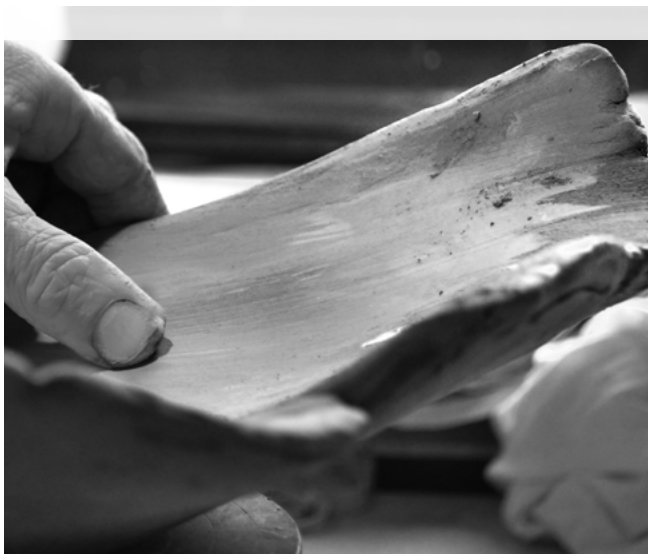
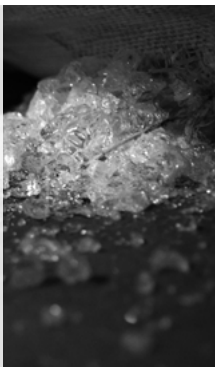
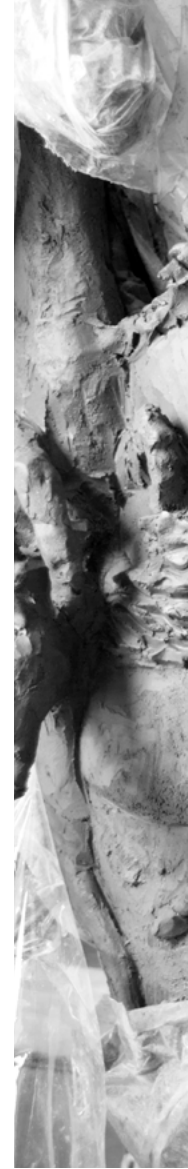

UNIVERS FLORAL <i>FLORAL UNIVERS</i>	12
UNIVERS ANIMALIER <i>ANIMAL UNIVERS</i>	82
DESIGN <i>DESIGN</i>	130
DÉCORATION <i>DECORATIION</i>	140
ARCHITECTURE D'INTÉRIEUR <i>INTERIOR ARCHITECTURE</i>	166



UNIVERS FLORAL
FLORAL UNIVERSE



Vase ultraviolet
Édition numérotée
H : 23 cm L : 22 cm l : 22 cm
4,5 kg

Ultraviolet vase
Numbered edition
H: 9.1" L: 8.7" W: 8.7"
10 lbs

Ref. 03839

Vase ultraviolet
Édition numérotée
H : 40 cm L : 30 cm l : 30 cm
13 kg

Ultraviolet vase
Numbered edition
H: 15.7" L: 11.8" W: 11.8"
28.7 lbs

Ref. 03938



Flacon de parfum
H : 12 cm L : 6,5 cm l : 2,5 cm
30 ml - 0,2 kg

Perfume bottle
H: 4.7" L: 2.5" W: 1"
1 oz - 0.3 lbs

Ref. 03922/C





Coupe ultraviolet
Édition numérotée
H : 8 cm L : 29,5 cm l : 20 cm
3 kg

Ultraviolet bowl
Numbered edition
H: 3.1" L: 11.6" W: 7.9"
6.6 lbs

Ref. 03939

Vide-poches ultraviolet
H : 5,5 cm L : 17,5 cm l : 12,5 cm
0,6 kg

Ultraviolet ornamental dish
H: 2.2" L: 6.9" W: 4.9"
1.3 lbs

Ref. 03997



Coupe ultraviolet
Édition limitée à 50 exemplaires
H : 18 cm L : 70 cm l : 32 cm
18,5 kg

Ultraviolet bowl
Limited edition of 50
H: 7.1" L: 27.6" W: 12.6"
40.8 lbs

Ref. 03490-1

ROBBA EMILIO



Emilio Robba est l'un des designers en Art Floral le plus reconnu dans le monde. Issu d'une famille d'artistes italiens, Emilio Robba sut dès son plus jeune âge que ses racines artistiques dicteraient sa vie. Il choisit tout d'abord de s'exprimer par la peinture, en étudiant aux Beaux-Arts le langage des formes et des couleurs. Il se tourne très rapidement vers l'art floral, guidé par sa fascination pour la nature. Il sculpte ses compositions florales avec beaucoup de sensibilité tout en suivant la mode et les tendances du design d'intérieur. En 2006 commence le chapitre d'une longue collaboration artistique entre Emilio Robba et Daum autour du thème de la nature.

Emilio Robba, crowned as the "Sculptor of Flowers" by the press, is one of the world's most recognized names in permanent botanicals and landscaping environments. Born into a family of Italian artists, he quickly became captivated by the artistic world.

His artistic roots led him to begin with painting, and he later studied colour and form at the prestigious Beaux-Arts School. He was drawn instinctively toward the floral art universe, where he constantly pushed through boundaries. Having sensitivity to fashion and design trends, he has created unique floral collections with exceptional quality and style.

Since 2006, Emilio Robba and the Maison Daum have started a chapter of a beautiful artistic collaboration surrounding the theme of nature.

BAMBOU BAMBOO

Coupe

H : 7,5 cm L : 22 cm l : 6,5 cm
0,5 kg

Bowl

H: 3" L: 8.7" W: 2.5"
1.2 lbs

Ref. 03370

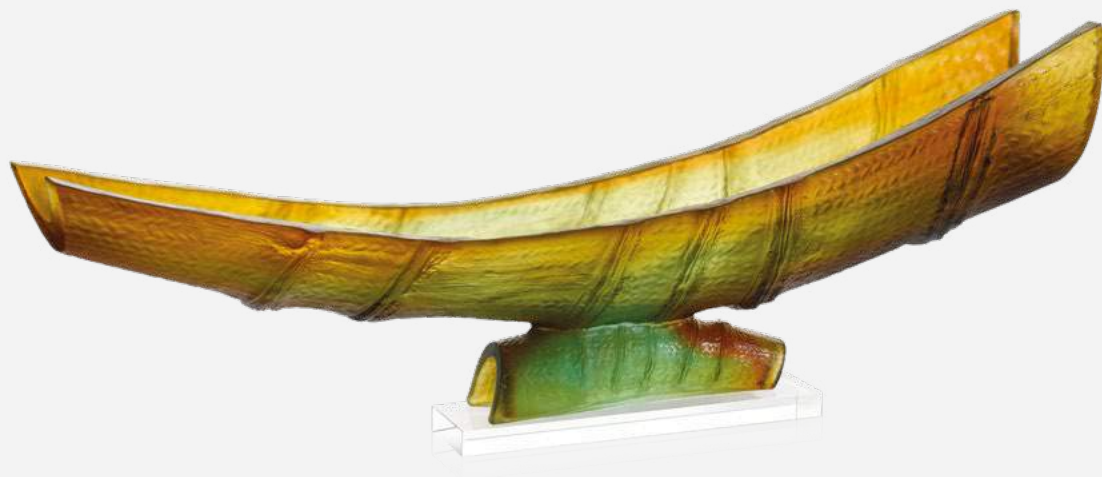
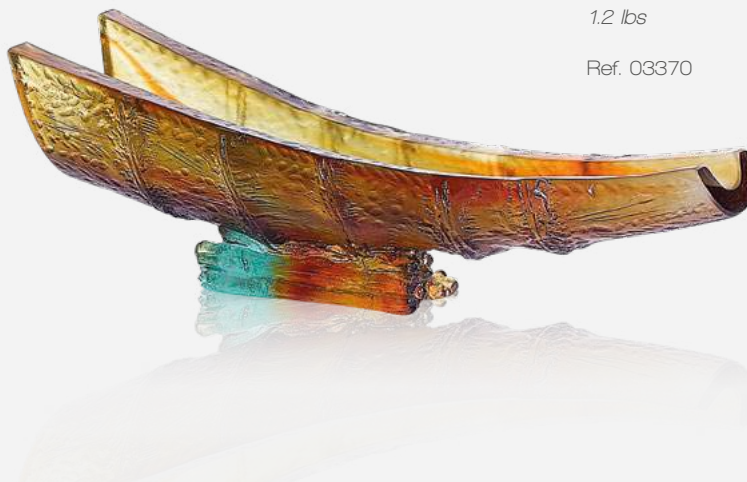

Coupe magnum

Édition limitée à 388 exemplaires
H : 29 cm L : 78,5 cm l : 15,5 cm
11,3 kg

Magnum bowl

Limited edition of 338
H: 11.4" L: 30.9" W: 6.1"
24.9 lbs

Ref. 03960

FEUILLE MURALE BORNÉO
BORNEO WALL LEAF



RÉFÉRENCE ARCHITECTURE D'INTÉRIEUR P186
INTERIOR ARCHITECTURE REFERENCE P186



Vase grand modèle
Édition limitée à 99 exemplaires
H : 60 cm L : 38 cm l : 36 cm
18 kg

Large vase
Limited edition of 99
H: 23.6" L: 15" W: 14.1"
39.7 lbs

Ref. 05520

Vase magnum
Édition limitée à 99 exemplaires
H : 83 cm Ø : 50 cm
35,5 kg

Magnum vase
Limited edition of 99
H: 33.5" Ø: 19.7"
78.3 lbs

Ref. 05536

Socle en bronze patiné
Base in patinated bronze



Vase moyen modèle
Édition limitée à 375 exemplaires
H : 39 cm L : 23,5 cm l : 21 cm
6,2 kg

Medium vase
Limited edition of 375
H: 15.4" L: 9.3" W: 8.3"
13.7 lbs

Ref. 05513





Centre de table magnum

Édition limitée à 225 exemplaires
H : 21 cm L : 72 cm l : 35 cm
11,7 kg

Magnum centerpiece

Limited edition of 225
H: 8.3" L: 28" W: 13.8"
25.8 lbs

Ref. 05537

Coupe

Édition limitée à 375 exemplaires
H : 14 cm L : 35 cm l : 35 cm
4,5 kg

Bowl

Limited edition of 375
H: 5.5" L: 13.8" W: 13.8"
9.9 lbs

Ref. 05521



Vase magnum arc en ciel
Édition limitée à 175 exemplaires
H : 34,5 cm L : 35 cm l : 37 cm
17,3 kg

Rainbow-coloured magnum vase
Limited edition of 175
H: 13.6" L: 13.8" W: 14.6"
38.2 lbs

Ref. 05396



Vase bleu vert
Édition numérotée
H : 22 cm L : 26 cm l : 26 cm
5,6 kg

Blue green vase
Numbered edition
H: 8.6" L: 10.2" W: 10.2"
12.3 lbs

Ref. 05361

Vase rouge violet
Édition numérotée
H : 22 cm L : 26 cm l : 26 cm
5,6 kg

Red purple vase
Numbered edition
H: 8.6" L: 10.2" W: 10.2"
12.3 lbs

Ref. 05361-1





Vase
Édition numérotée
H : 28 cm L : 17 cm l : 17 cm
3,9 kg

Vase
Numbered piece
H: 11" L: 6.7" W: 6.7"
8,5 lbs

Ref. 03728



Vase
Édition numérotée
H : 49,5 cm L : 29 cm l : 29 cm
13,4 kg

Vase
Numbered edition
H: 19.4" L: 11.4" W: 11.4"
29.5 lbs

Ref. 03727

Coupe
Édition numérotée
H : 13 cm L : 51 cm l : 30,5 cm
6,4 kg

Bowl
Numbered edition
H: 5.1" L: 20.1" W: 12"
14.1 lbs

Ref. 03729





Vase

Édition numérotée

H : 42 cm L : 25 cm l : 25 cm

8,7 kg

Vase

Numbered edition

H: 16.5" L: 9.8" W: 9.8"

19.1 lbs

Ref. 03765

Vase

Édition limitée à 388 exemplaires

H : 56 cm L : 23 cm l : 23 cm

10,3 kg

Vase

Limited edition of 388

H: 22" L: 9.1" W: 9.1"

22.7 lbs

Ref. 03962



Vase

Édition numérotée

H : 20 cm L : 14 cm l : 14 cm

1,2 kg

Vase

Numbered edition

H: 7.9" L: 5.5" W: 5.5"

2.6 lbs

Ref. 03847



Coupe

Édition limitée à 388 exemplaires
 H : 18 cm L : 69,5 cm l : 22 cm
 8,7 kg

Bowl

Limited edition of 388
 H: 7" L: 27.4" W: 8.7"
 19.1 lbs

Ref. 03766



Solfiore

Édition numérotée
 H : 14 cm L : 32,5 cm l : 11 cm
 1,6 kg

Solfiore

Numbered edition
 H: 5.5" L: 12.8" W: 4.3"
 3.5 lbs

Ref. 03788



Vase rouge violet
Édition numérotée
H : 25 cm L : 14 cm l : 14 cm
2,8 kg

Purple red vase
Numbered edition
H : 9.8" L : 5.5" W : 5.5"
6.2 lbs

Réf. 05510-1



Vase GM bleu ambre
Édition numérotée
H : 36,5 cm Ø : 15 cm
5,3 kg

Large blue amber vase
Numbered edition
H: 14.4" Ø: 5.9"
11.7 lbs

Réf. 05485



Vase coupe rouge violet
Édition numérotée
H : 10 cm L : 32 cm l : 30 cm
5,2 kg

Purple red centerpiece
Numbered edition
H : 3.9" L : 12.6" W : 11.8"
11,5 lbs

Réf. 05514





Coupe GM bleu ambre

Édition numérotée
H : 6 cm Ø : 32 cm
4,6 kg

Large blue amber bowl

Numbered edition
H : 2.4" Ø : 12.6"
10.1 lbs

Réf. 05477



Coupe PM bleu nuit ambre

Édition numérotée
H : 3,5 cm Ø : 17 cm
0,9 kg

Small night blue amber bowl

Numbered edition
H: 1.4" Ø: 6.7"
2 lbs

Réf. 05484



Flacon à parfum

H : 11,5 cm L : 6 cm l : 2,5 cm
30 ml - 0,1 kg

Perfume bottle

H: 4.5" L: 2.4" W: 1"
1 oz - 0.2 lbs

Réf. 05459/C



Vase GM Vert Émeraude Finition Or (à la feuille d'or)

Édition limitée à 75 exemplaires

H : 34 cm Ø : 30 cm

16,7 Kg

Large Emerald Green Vase with Gilded Finish

Limited edition of 75

H: 13.4" Ø: 11.8"

36 lbs

Ref : 05584-1

Vase GM Vert Émeraude

Édition limitée à 175 exemplaires

H : 34 cm Ø : 30 cm

16,7 Kg

Large Emerald Green Vase

Limited edition of 175

H: 13.4" Ø: 11.8"

36 lbs

Ref : 05584





Vase MM Bleu

Édition limitée à 375 exemplaires

H : 22,5 cm Ø : 22 cm

7,1 Kg

Medium Blue Vase

Limited edition of 375

H: 8.9" Ø: 8.7"

15,7 lbs

Ref : 05588

Bougeoir Vert

H : 10 cm Ø : 6 cm

0,5 Kg

Green Candle Holder

H: 3.9" Ø: 2.4"

1 lbs

Ref : 05589-1

Coffret de 2 bougeoirs verts
Set of 2 Green candle holders

Ref : 05589-1/P



Bougeoir Bleu

H : 10 cm Ø : 6 cm

0,5 Kg

Blue Candle Holder

H: 3.9" Ø: 2.4"

1 lbs

Ref : 05589

Coffret de 2 bougeoirs bleus
Set of 2 Blue candle holders

Ref : 05589/P



FLEURS D'ORCHIDÉE
FLOWERS OF ORCHID



Coupe Fleurs d'Orchidée
Édition numérotée
Ø : 28 cm H : 6 cm
2,8 kg

Flowers of Orchid bowl
Numbered edition
Ø: 11" H: 2.4"
6.2 lbs

Ref : 05543



Coupelle Fleurs d'Orchidée
Ø : 14 cm H : 4 cm
0,4 kg

Flowers of Orchid small bowl
Ø: 5.6" H: 1.6"
1 lbs

Ref : 05553



Flacon à parfum prestige Fleurs d'Orchidée
L : 10 cm H : 22 cm
160 ml - 0,9 kg

Flowers of Orchid prestige perfume bottle
Ø: 4" H : 8.7"
5.4 oz - 2,1 lbs

Ref : 05551

FLEURS D'ORCHIDÉE

FLOWERS OF ORCHID



Disque décoratif Fleurs d'Orchidée
Édition numérotée
Ø : 38 cm H : 40 cm
6,6 kg

Flowers of Orchid decorative disk
Numbered edition
Ø: 15" H: 15.8"
14.6 lbs

Ref : 05548

Fleur décorative Fleurs d'Orchidée
H : 10 cm L : 12 cm l : 6 cm
0,4 kg

Flowers of Orchid decorative flower
H : 4" L : 4.8" W : 2.4"
1 lbs

Ref : 05535



Vase magnum vert
Édition limitée à 99 exemplaires
H : 52 cm L : 40 cm l : 40 cm
28 kg

Magnum green vase
Limited edition of 99
H: 20.5" L: 15.7" W: 15.7"
61 lbs

Ref. 05107



Vase magnum ambre
Édition limitée à 99 exemplaires
H : 52 cm L : 40 cm l : 40 cm
28 kg

Magnum amber vase
Limited edition of 99
H: 20.5" L: 15.7" W: 15.7"
61 lbs

Ref. 05107-3





Vase GM ambre
Pièce numérotée
H : 30 cm L : 28 cm l : 28 cm
5,6 kg

Large amber Vase
Numbered piece
H: 11.8" L: 11" W: 11"
12.4 lbs

Ref. 03409-3

Vase GM vert
Pièce numérotée
H : 30 cm L : 28 cm l : 28 cm
5,6 kg

Large green Vase
Numbered piece
H: 11.8" L: 11" W: 11"
12.4 lbs

Ref. 03409





Vase MM vert
Pièce numérotée
H : 17 cm L : 14 cm l : 14 cm
1,4 kg

Medium green Vase
Numbered piece
H: 6.7" L: 5.5" W: 5.5"
3.1 lbs

Ref. 03410



Vase MM ambre
Pièce numérotée
H : 17 cm L : 14 cm l : 14 cm
1,4 kg

Medium green Vase
Numbered piece
H: 6.7" L: 5.5" W: 5.5"
3.1 lbs

Ref. 03410-3



Mini-vase ambre
H : 7 cm L : 5,5 cm l : 5,5 cm
0,1 kg

Amber mini-vase
H: 2.7" L: 2" W: 2"
0,3 lbs

Ref. 05157-3/C



Mini-vase vert
H : 7 cm L : 5,5 cm l : 5,5 cm
0,1 kg

Green Mini-vase
H: 2.7" L: 2" W: 2"
0,3 lbs

Ref. 05157/C

**Coupe haute verte**

H : 12 cm L : 29 cm l : 29 cm
2,9 kg

Green bowl

H: 4.7" L: 11.4" W: 11.4"
6.3 lbs

Ref. 03570

Coupe haute ambre

Edition numérotée
H : 12 cm L : 29 cm l : 29 cm
2,9 kg

Amber bowl

Numbered edition
H: 4.7" L: 11.4" W: 11.4"
6.3 lbs

Ref. 03570-3

**Coupe magnum**

Pièce numérotée
H : 9 cm L : 42 cm l : 32 cm
4,7 kg

Magnum bowl

Numbered piece
H: 3.5" L: 16.5" W: 12.6"
10.4 lbs

Ref. 05108





Coupe feuille GM verte
Edition numérotée
H : 13 cm L : 34 cm
3,3 kg

Large green leaf
Numbered edition
H: 5.1" L: 13.3"
7.2 kg

Ref. 05578-1

Coupe feuille GM ambre
Edition numérotée
H : 13 cm L : 34 cm
3,3 kg

Large amber leaf
Numbered edition
H: 5.1" L: 13.3"
7.2 kg

Ref. 05578



Feuille verte
H : 3,4 cm L : 9,5 cm l : 7,5 cm
0,1 kg

Green leaf
H: 1.4" L: 3.7" W: 3"
0.3 lbs

Ref. 03572



Feuille ambre
H : 3,4 cm L : 9,5 cm l : 7,5 cm
0,1 kg

Amber leaf
H: 1.4" L: 3." W: 3"
0.3 lbs

Ref. 03572-3



Coupelle verte

H : 4,6 cm L : 11,9 cm l : 11,9 cm
0,25 kg

Small green bowl

H: 1.7" L: 4.7" W: 4.7"
0.55 lbs

Ref. 03571

**Coupelle ambre**

H : 4,6 cm L : 11,9 cm l : 11,9 cm
0,25 kg

Small amber bowl

H: 1.7" L: 4.7" W: 4.7"
0.55 lbs

Ref. 03571-3

**Facon de parfum vert**

H : 11,7 cm L : 6,5 cm l : 2,5 cm
30 ml - 0,15 kg

Green Perfume bottle

H: 4.1" L: 2.5" W: 1"
1 oz - 0.33 lbs

Ref. 03920/C

**Facon de parfum ambre**

H : 11,7 cm L : 6,5 cm l : 2,5 cm
30 ml - 0,15 kg

Amber perfume bottle

H: 4.1" L: 2.5" W: 1"
1 oz - 0.33 lbs

Ref. 03920-3/C

Vase MM Hibiscus

Edition limitée à 225 exemplaires
H : 30 cm L : 35 cm l : 22 cm
10,5 kg

Medium Hibiscus vase

Limited edition of 225
H : 11,8" L : 13,8" W : 8,7"
23.5 lbs

Réf. 05494



Vase GM Hibiscus

Edition limitée à 99 exemplaires
H : 52 cm L : 40 cm l : 30 cm
39,7 kg

Large Hibiscus vase

Limited edition of 99
H : 20.5" L : 15.7" W : 11.8"
87.5 lbs

Réf. 05493

Coupe magnum Hibiscus

Edition limitée à 225 exemplaires
 H : 21,5 cm L : 46 cm l : 30 cm
 8,1 kg

Magnum Hibiscus bowl

Limited edition of 225
 H: 8,5" L: 18,1" W: 11,8"
 17;9 LBS

Réf. 05511



Flacon à parfum Hibiscus

H : 10 cm L : 4,6 cm l : 4,6 cm
 30 ml - 0,1 kg

Hibiscus perfume bottle

H: 3,9" L: 1,8" W: 1,8"
 1 oz - 0.3 lbs

Réf. 05515/C



Fleur décorative Hibiscus

H : 6,6 cm L : 11 cm l : 11 cm
 0,3 kg

Hibiscus Decorative flower

H : 2,6" L : 4,3" W : 4,3"
 0.7 lbs

Réf. 05508



Coupe

H : 18,5 cm L : 33 cm l : 33 cm
3,50 kg

Bowl

H: 7.2" L: 13" W: 13"
7.70 lbs

Ref. 01633



Vide poches

H : 7,5 cm L : 18,5 cm l : 10,5 cm
0,50 kg

Ornamental dish

H: 3" L: 7.3" W: 4.1"
1.10 lbs

Ref. 01641

Vase

H : 13,5 cm L : 13 cm l : 8 cm
0,97 kg

Vase

H: 5.3" L: 5.1" W: 3.1"
2.13 lbs

Ref. 02754



Vase

H : 27,5 cm L : 13 cm l : 13 cm
2,34 kg

Vase

H: 11" L: 5.1" W: 5.1"
5.15 lbs

Ref. 03538





Flacon de parfum carré
 H : 20 cm L : 12 cm l : 12 cm
 160 ml - 0,7 kg

Perfume bottle square
 H: 7.9" L: 4.7" W: 4.7"
 5.4 oz - 1.6 lbs

Ref. 02755



Flacon de parfum rond
 H : 12,5 cm L : 7,5 cm l : 7,5 cm
 35 ml - 0,28 kg

Perfume bottle round
 H: 4.9" L: 3" W: 3"
 1.2 oz - 0.6 lbs

Ref. 02756



Mini-coupelle
 H : 4,2 cm L : 9,5 cm l : 5,2 cm
 0,09 kg

Mini-bowl
 H: 1.7" L: 3.7" W: 2"
 0.20 lbs

Ref. 01639



Flacon de parfum violet
 H : 13 cm L : 8 cm l : 8 cm
 140 ml - 0,28 kg

Perfume bottle purple
 H: 5.1" L: 3.1" W: 3.1"
 0.62 lbs
 4.7 oz - 0.6 lbs

Ref. 02504-1



Fleur violette
 H : 4,6 cm L : 10,5 cm l : 10,1 cm
 0,22 kg

Purple flower
 H: 1.4" L: 4.1" W: 4"
 0.48 lbs

Ref. 02503-1



Vase jungle
Édition limitée à 225 exemplaires
H : 33,5 cm L : 35 cm I : 22 cm
13,6 kg

Jungle Vase
Limited edition of 225
H: 13.2" L: 13.8" I: 8.7"
30.8 lbs

Ref. 05351



Vase jungle rouge
Edition numérotées
H : 13,5 cm L : 13 cm I : 12,5 cm
1,2 kg

Red small vase
Numbered edition
H: 5.3" L: 5.1" I: 5"
2.6 lbs

Ref. 05456-1

Vase ovale jungle
Édition limitée à 99 exemplaires
H : 62 cm L : 40 cm I : 30 cm
40 kg

Jungle oval vase
Limited edition of 99
H: 24.2" L: 15.3" W: 11.8"
88 lbs

Ref. 05337



Coupe magnum
Édition limitée à 225 exemplaires
H : 34 cm L : 44 cm l : 30 cm
10 kg

Magnum bowl
Limited edition of 225
H: 13.3" L: 17.1" W: 11.4"
22 lbs

Ref. 05352



Coupe
Pièce numérotée
H : 6 cm L : 27 cm l : 17,5 cm
1,5 kg

Bowl
Numbered piece
H: 2.3" L: 10.5" W: 6.8"
3.08 lbs

Ref. 05369

Photophore
Pièce numérotée
H : 13,5 cm L : 13 cm l : 13 cm
1,6 kg

Large candle holder
Numbered piece
H: 5.3" L: 5.1" W: 5.1"
3.52 lbs

Ref. 05395

Recharge bougie éclat de nature
H : 10 cm

Eclat de nature candle
H : 3,9"

Ref. 03451



FEUILLE MURALE MONSTERA
MONSTERA WALL LEAF







Coupe moyen modèle Monstera
Edition limitée à 375 exemplaires
H : 13,5 cm L : 40 cm l : 37 cm
5,3 kg

Medium Monstera bowl
Limited edition of 375
H : 5,3" L : 15,8" W : 14,6"
11.7 lbs

Ref. 05550

Vase bleu nuit
Pièce numérotée
H : 30 cm L : 25 cm l : 11 cm
9 kg

Dark blue vase
Numbered piece
H: 11.8" W: 9.8" 4.3"
19 lbs

Ref. 05103



Vide-poche
Pièce numérotée
H : 8 cm L : 25,5 cm l : 13 cm
0,93 kg

Ornamental dish
Numbered piece
H: 3.1" L: 10" W: 5.1"
2.05 lbs

Ref. 03918





Vase
Pièce numérotée
H : 23,5 cm L : 25 cm l : 8,3 cm
4,60 kg

Vase
Numbered piece
H: 9.2" L: 9" W: 3.2"
10.12 lbs
Ref. 03456



Vase
Edition limitée à 388 exemplaires
H : 57 cm L : 51,7 cm l : 39 cm
18 kg

Vase
Limited edition of 388
H: 22.4" L: 20.3" W: 15.3"
39.60 lbs

Ref. 03458



Coupe

Edition limitée à 388 exemplaires
H : 27 cm L : 61 cm l : 61 cm
16,40 kg

Bowl

Limited edition of 388
H: 10.6" L: 24" W: 24"
36.08 lbs

Ref. 03457

Coupe

Edition numérotée
H : 11 cm L : 21 cm l : 21 cm
1,30 kg

Bowl

Numbered edition
H: 4.3" L: 8.2" W: 8.2"
2.86 lbs

Ref. 03684





Vase blanc rosé

Pièce numérotée

H : 38 cm L : 29 cm l : 29 cm

12,30 kg

Powdered white vase

Numbered piece

H: 15" L: 11.4" W: 11.4"

27.06 lbs

Ref. 05153-1

Vase vert-dense mauve

Pièce numérotée

H : 38 cm L : 29 cm l : 29 cm

12,30 kg

Deep green purple white vase

Numbered piece

H: 15" L: 11.4" W: 11.4"

27.06 lbs

Ref. 05153





Vase vert violet

Pièce numérotée

H : 17 cm L : 12 cm l : 12 cm

1,2 kg

Green purple vase

Numbered piece

H: 6.7" W: 4.7" W: 4.7"

2 lbs

Ref. 05215-2

Vase vert et rose

H : 30 cm L : 28,5 cm l : 28,5 cm
8,80 kg

Green and pink vase

H: 11.8" L: 11.2" W: 11.2"
19.36 lbs

Ref. 03547



Vase ultraviolet

Pièce numérotée

H : 30 cm L : 28,5 cm l : 28,5 cm
8,80 kg

Ultraviolet vase

Numbered piece

H: 11.8" L: 11.2" W: 11.2"
19.36 lbs

Ref. 03547-2



Vase vert et rose

H : 17,5 cm L : 14 cm l : 14 cm
1,27 kg

Green and pink vase

H: 6.9" L: 5.5" W: 5.5"
2.79 lbs

Ref. 03507



Vase vert et rose

H : 22,5 cm L : 18 cm l : 18 cm
2,27 kg

Green and pink vase

H: 8.8" L: 7" W: 7"
4.99 lbs

Ref. 02570



Coupe rose

H : 9 cm L : 27 cm l : 27 cm
2,44 kg

Pink Dish

H: 3.5" L: 10.6" W: 10.6"
5.37 lbs

Ref. 01672



Coupe sur pied

H : 13,5 cm L : 35,5 cm l : 35,5 cm
5,22 kg

Footed bowl

H: 5.2" L: 14" W: 14"
11.48 lbs

Ref. 01612

Coupelle creuse

H : 4,5 cm L : 13,5 cm l : 13,5 cm
0,33 kg

Shallow dish

H: 1.7" L: 5.3" W: 5.3"
0.73 lbs

Ref. 01963



**Mini coupelle**

H : 4 cm L : 9,5 cm l : 7,5 cm
0,12 kg

Mini bowl

H: 1.5" L: 3.7" W: 3"
0.26 lbs

Ref. 01673

**Vide poches**

H : 5,5 cm L : 19 cm l : 19 cm
0,71 kg

Ornamental dish

H: 2.1" L: 7.5" W: 7.5"
1.56 lbs

Ref. 02571

Flûte à champagne

H : 30 cm L : 7 cm l : 7 cm
0,42 kg

Champagne flute

H: 11.8" L: 2.7" W: 2.7"
0.92 lbs

Ref. 01141



Cadre

H : 9 cm L : 9 cm l : 2 cm
0,17 kg

Frame

H: 3.5" L: 3.5" W: 0.8"
0.37 lbs

Ref. 03235



Boîte

H : 11 cm L : 12 cm l : 12 cm
0,97 kg

Box

H: 4.3" L: 4.7" W: 4.7"
2.13 lbs

Ref. 01962



**Bougie**

H : 12 cm L : 14 cm l : 14 cm
0,84 kg

Candleholder

H: 4.7" L: 5.5" W: 5.5"
1.84 lbs

Ref. 02618

Recharge bougie Ô Printemps

H : 10 cm L : 9,5 cm l : 9,5 cm
0,18 kg

Candle Ô Spring

H: 3.9" L: 3.7" W: 3.7"
0.40 lbs

Ref. 03451-1

Recharge bougie éclat de nature

H : 9 cm L : 9 cm l : 9 cm
0,42 kg

Eclat de nature candle refill

H: 3.5" L: 3.5" W: 3.5"
0.92 lbs

Ref. 03451

Bougie rose

H : 8,2 cm L : 9,5 cm l : 9 cm
0,30 kg

Pink candleholder

H: 3.2" L: 3.7" W: 3.5"
0.66 lbs

Ref. 02666-1

Recharge bougie fleur de litchi

H : 5,2 cm L : 4,6 cm l : 4,6 cm
0,10 kg

Flower of litchi candle refill

H: 2" L: 1.7" W: 1.7"
0.22 lbs

Ref. 02665



ROSE ETERNELLE

ETERNAL ROSE



Rose Eternelle Rouge
Edition numérotée
H : 8,5 cm L : 27 cm l : 7 cm
0,4 kg

Red Eternal Rose
Numbered edition
H: 3.3" L: 10.6" W: 2.8"
0.8 lbs

REF : 05590



Rose Eternelle
Edition numérotée
H : 8,5 cm L : 27 cm l : 7 cm
0,4 kg

Eternal Rose
Numbered edition
H: 3.3" L: 10.6" W: 2.8"
0.8 lbs

REF : 05590-1

Tige dorée à l'or 24 carats
Stem gilded in 24k gold



Socle en verre
H : 3,5 cm Ø 9 cm

Glass base
H: 1.4" Ø 3.5"

REF : 328979





Vase magnum vert & orange
Édition limitée à 99 exemplaires
H : 53 cm Ø : 40 cm
27 Kg

Green & orange magnum vase
Limited edition of 99
H: 20.8" Ø: 15.7"
59 lbs

Ref. 05106-2



Vase Magnum Vert Orange & Bouquet or
Édition limitée à 25 exemplaires
H : 53 cm Ø : 40 cm
27 Kg

Green & Orange Magnum Vase with gilded Bouquet
Limited edition of 25
H: 20.8" Ø: 15.7"
59 lbs

Ref. 05376-3



Vase magnum blanc
Édition limitée à 50 exemplaires
H : 53 cm Ø : 40 cm
27 Kg

White magnum vase
Limited edition of 50
H: 20.8" Ø: 15.7"
59 lbs

Ref. 05106-5



Vase magnum blanc & bouquet rouge & or
Édition limitée à 50 exemplaires
H : 53 cm L : 40 cm l : 40 cm
26,9 kg

White magnum vase with red & gold bouquet
Limited edition of 50
H: 20.8" L: 15.7" W: 15.7"
59 lbs

Ref. 05376-2



Vase magnum blanc & fleur verte rose
Édition limitée à 50 exemplaires
H : 53 cm L : 40 cm l : 40 cm
26,9 kg

White magnum vase & green pink flower 50 ex
Limited edition of 50
H: 20.8" L: 15.7" W: 15.7"
59 lbs

Ref. 05106-8



Vase rouge & fleur blanche
Édition limitée à 375 exemplaires
H : 35 cm L : 25 cm l : 25 cm
8,6 Kg

Red vase & white flower
Limited edition of 375
H: 13.8" L: 9.8" W: 9.8"
18 lbs

Ref. 05308-1



Vase vert & rose
Pièce numérotée
H : 35 cm L : 25 cm l : 25 cm
8,6 Kg

Green & pink vase
Numbered piece
H: 13.8" L: 9.8" W: 9.8"
18 lbs

Ref. 05282



Vase vert & orange
Pièce numérotée
H : 35 cm L : 25 cm l : 25 cm
8,6 Kg

Green & orange vase
Numbered piece
H: 13.8" L: 9.8" W: 9.8"
18 lbs

Ref. 05282-2



Vase gris & fleur violette

Édition limitée à 500 exemplaires
H : 35 cm L : 25 cm l : 25 cm
8,6 Kg

Grey vase & purple flower

Limited edition of 500
H: 13.8" L: 9.8" W: 9.8"
18 lbs

Ref. 05308-3



Vase blanc & fleur rouge

Édition limitée à 500 exemplaires
H : 35 cm L : 25 cm l : 25 cm
8,6 Kg

White vase & red flower

Limited edition of 500
H: 13.8" L: 9.8" W: 9.8"
18 lbs

Ref. 05308



Vase blanc & fleur rouge

Pièce numérotée

H : 17 cm L : 14,5 cm l : 14,5 cm

1,3 Kg

White vase with red flower

Numbered piece

H: 6.7" L: 5.7" W: 5.7"

2 lbs

Ref. 05287-6



Vase vert & rose

Pièce numérotée

H : 17 cm L : 14,5 cm l : 14,5 cm

1,3 Kg

Green & pink vase

Numbered piece

H: 6.7" L: 5.7" W: 5.7"

2 lbs

Ref. 05287



Vase vert & orange

Pièce numérotée

H : 17 cm L : 14,5 cm l : 14,5 cm

1,3 Kg

Green & orange vase

Numbered piece

H: 6.7" L: 5.7" W: 5.7"

2 lbs

Ref. 05287-2



Vase Bleu Fleur Blanche

Pièce numérotée

H : 17 cm L : 14,5 cm l : 14,5 cm

1,3 Kg

Blue Vase with White Flower

Numbered piece

H: 6.7" L: 5.7" W: 5.7"

2 lbs

Ref. 05287-7



Vase rouge & violet
 Pièce numérotée
 H : 17 cm L : 14,5 cm l : 14,5 cm
 1,3 Kg

Red & purple vase
 Numbered piece
 H: 6.7" L: 5.7" W: 5.7"
 2 lbs

Ref. 05287-5



Vase bleu mauve
 Pièce numérotée
 H : 17 cm L : 14,5 cm l : 14,5 cm
 1,3 Kg

Blue purple vase
 Numbered piece
 H: 6.7" L: 5.7" W: 5.7"
 2 lbs

Ref. 05287-3



Vase blanc
 Pièce numérotée
 H : 17 cm L : 14,5 cm l : 14,5 cm
 1,3 Kg

White vase
 Numbered piece
 H: 6.7" L: 5.7" W: 5.7"
 2 lbs

Ref. 05287-1



Mini-vase vert & rose
 H : 7 cm L : 5 cm l : 5 cm
 0,110 Kg

Green & pink mini-vase
 H: 2.7" L: 2" W: 2"
 0.22 lbs

Ref. 05264-1/C

ROSE PASSION



Coupe magnum rose & verte

Edition limitée à 50 exemplaires

H : 15 cm L : 61 cm l : 43 cm

13,8 kg

Pink & green Rose Passion magnum bowl

Edition of 50

H: 6" L: 24" W: 17"

30.4 lbs

Ref. 05442

Coupe verte & rose

Pièce numérotée

H : 9,5 cm L : 28,5 cm l : 22 cm

2,45 kg

Green & pink bowl

Numbered piece

H: 3.7" L: 11.2" W: 8.6"

5.40 lbs

Ref. 05314



Coupe verte & orange

Pièce numérotée

H : 9,5 cm L : 28,5 cm l : 22 cm

2,45 kg

Green & orange bowl

Numbered piece

H: 3.7" L: 11.2" W: 8.6"

5.40 lbs

Ref. 05314-1





Coupelle verte & orange
H : 5,5 cm L : 13,5 cm l : 11 cm
0,360 Kg

Green & orange small bowl
H: 2.1" L: 5.3" W: 4.3"
0.72 lbs

Ref. 05289-2

Coupelle verte & rose
H : 5,5 cm L : 13,5 cm l : 11 cm
0,360 Kg

Green & pink small bowl
H: 2.1" L: 5.3" W: 4.3"
0.72 lbs

Ref. 05289



Coupelle rouge & violette
H : 5,5 cm L : 13,5 cm l : 11 cm
0,360 Kg

Red and purple small bowl
H: 2.1" L: 5.3" W: 4.3"
0.72 lbs

Ref. 05289-3





Fleur blanche

H : 6,5 cm L : 11 cm l : 11 cm
0,550 Kg

White flower

H: 2.5" L: 4.3" W: 4.3"
1.110 lbs

Ref. 05290

Fleur verte & rose

H : 6,5 cm L : 11 cm l : 11 cm
0,550 Kg

Green & pink flower

H: 2.5" L: 4.3" W: 4.3"
1.110 lbs

Ref. 05290-4



Fleur rose

H : 6,5 cm L : 11 cm l : 11 cm
0,550 Kg

Pink flower

H: 2.5" L: 4.3" W: 4.3"
1.110 lbs

Ref. 05290-5

Fleur UV

H : 6,5 cm L : 11 cm l : 11 cm
0,550 Kg

UV flower

H: 2.5" L: 4.3" W: 4.3"
1.110 lbs

Ref. 05290 -3



Fleur rouge

H : 6,5 cm L : 11 cm l : 11 cm
0,550 Kg

Red flower

H: 2.5" L: 4.3" W: 4.3"
1.110 lbs

Ref. 05290-1

Fleur verte & orange

H : 6,5 cm L : 11 cm l : 11 cm
0,550 Kg

Green & orange flower

H: 2.5" L: 4.3" W: 4.3"
1.110 lbs

Ref. 05290-6



Bougeoir rouge
H : 6 cm L : 12 cm l : 12 cm
0,440 kg

Red candle holder
H: 2.3" L: 4.7" l: 4.7"
0.88 lbs

Ref. 05368-2



Flacon de parfum rose
H : 10,2 cm L : 4,5 cm l : 5 cm
30 ml - 0,150 Kg

Pink perfume bottle
H: 4" L: 1.7" W: 2"
1 oz - 0.30 lbs

Ref. 05270/C

Flacon de parfum framboise
H : 10,2 cm L : 4,5 cm l : 5 cm
30 ml - 0,150 Kg

Framboise perfume bottle
H: 4" L: 1.7" W: 2"
1 oz - 0.30 lbs

Ref. 05270-1/C



Facon PM verte
H : 10,5 cm L : 8 cm l : 8 cm
15 ml - 0,5 kg

Small green Perfume Bottle
H: 4.1" L: 3.1" W: 3.1"
0.5 oz - 1.2 lbs

Ref. 05625



Facon PM rose
H : 10,5 cm L : 8 cm l : 8 cm
15 ml - 0,5 kg

Small pink Perfume Bottle
H: 4.1" L: 3.1" W: 3.1"
0.5 oz - 1.2 lbs

Ref. 05625-1



Facon prestige
Edition numérotée
H : 18,5 cm L : 8,5 cm l : 7 cm
125 ml - 0.7 lbs

Prestige Perfume Bottle
Numbered edition
H: 7.3" L: 3.3" W: 2.8"
4.2 oz - 1.5 lbs

Ref. 05617



Fleur décorative
H : 9 cm L : 11 cm l : 11 cm
0,9 kg

Decorative rose flower
H: 3.5" L: 4.3" W: 4.3"
2 lbs

Ref. 05615





Vase GM Safran
Edition numérotée
H : 35 cm L : 29 cm
9,5 Kg

Large Safran vase
Numbered edition
H: 13.7" L: 11.4"
20 lbs

Ref. 05604

Vase MM Safran
Edition numérotée
H : 27 cm L : 21,5 cm l : 16 cm
4,5 Kg

Medium Safran vase
Numbered edition
H: 10.6" L: 8.3" W: 6.3"
9 lbs

Ref. 05601



Vase PM Safran
Edition numérotée
H : 16 cm L : 13 cm
1 Kg

Medium Safran vase
Numbered edition
H: 6.3" L: 5"
2 lbs

Ref. 05610





Coupe Safran GM Safran

Edition numérotée
H : 12 cm L : 34 cm
3 Kg

Saffron bowl

Numbered edition
H: 4.7" L: 13.3"
6 lbs

Ref. 05611



Fleur Décorative GM Safran

H : 11,5 cm L : 11 cm l : 13 cm
0,6 Kg

Saffron bowl

H: 4.3" L: 4.3" W: 5.1"
1 lbs

Ref. 05603



Fleur Décorative PM Safran

H : 6,5 cm L : 11 cm l : 10 cm
0,3 Kg

Small Saffron decorative flower

H: 2.6" L: 4.3" W: 3.9"
0,5 lbs

Ref. 05600



Flacon à parfum Safran

H : 6,5 cm L : 8 cm l : 8 cm
140 ml - 0,3 Kg

Saffron perfume bottle

H: 6.3" L: 3.1" W: 3.1"
4.7 oz - 0,5 lbs

Ref. 05609



Coupe

Pièce numérotée

H : 12,5 cm L : 45 cm l : 15,5 cm
2,50 kg

Bowl

Numbered piece

H: 4.9" L: 17.7" W: 6.1"
5.50 lbs
Ref. 03609



Coupe

Édition limitée à 388 exemplaires

H : 18 cm L : 97 cm l : 37 cm
10,50 kg

Bowl

Limited edition of 388

H: 7" L: 38.1" W: 14.5"
23.10 lbs

Ref. 03612

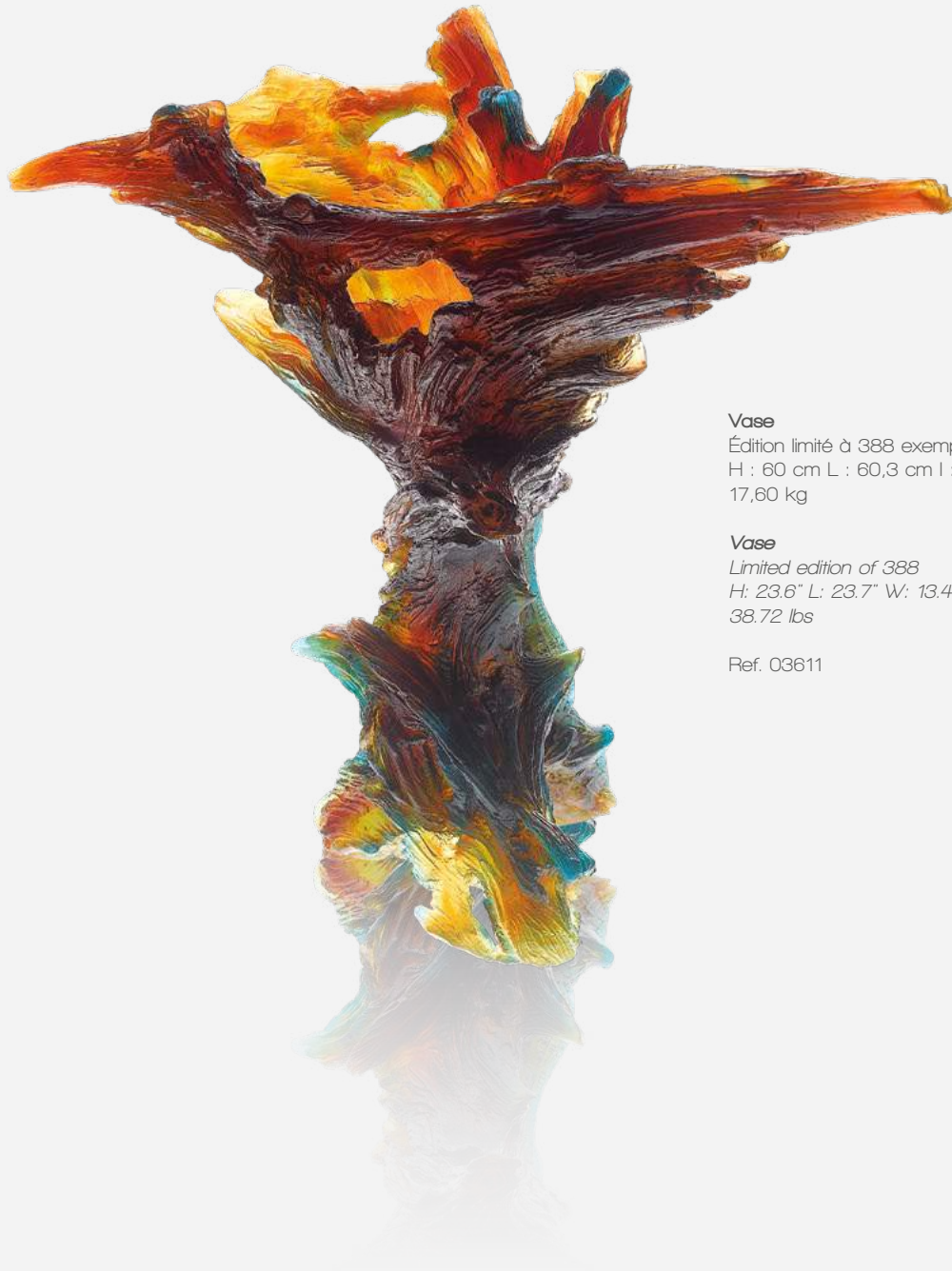

Vase

Édition limitée à 388 exemplaires
H : 60 cm L : 60,3 cm l : 34 cm
17,60 kg

Vase

Limited edition of 388
H: 23.6" L: 23.7" W: 13.4"
38.72 lbs

Ref. 03611



Vase petit modèle Tressage
Edition numérotée
H : 21 cm L : 17 cm l : 17 cm
2 kg

Small Tressage Vase
Numbered edition
H: 8.3" L: 6.7" W: 6.7"
4.3 lbs

REF : 05627



Vase grand modèle Tressage
Edition numérotée
H : 37 cm L : 31 cm l : 31 cm
9,9 kg

Large Tressage Vase
Numbered edition
H: 14.6" L: 12.2" W: 12.2"
21.7 lbs

REF : 05637



Vase Magnum Tressage
Edition numérotée
H : 50,5 cm L : 43 cm l : 43 cm
17,8 kg

Magnum Tressage Vase
Numbered edition
H: 19.9" L: 16.9" W: 16.9"
39.3 lbs

REF : 05630



Coupe grand modèle Tressage

H : 10,5 cm Ø : 28 cm

5,1 kg

Large Tressage Bowl

H: 4.1" Ø: 11"

11.2 lbs

REF : 05638

Coupe moyen modèle Tressage

H : 12 cm L : 26 cm l : 16 cm

1,6 kg

Medium Tressage Bowl

H: 4.7" L: 10.2" W: 6.3"

3.6 lbs

REF : 05629



Fleur decorative Tressage

H : 5,5 cm L : 13 cm l : 9 cm

0,3 kg

Tressage decorative flower

H: 2.2" L: 5.1" W: 3.5"

0.6 lbs

REF : 05655





Vase magnum rouge à l'or
Édition limitée à 50 exemplaires
H : 52,5 cm L : 41 cm l : 41 cm
27,30 kg

"Rouge à l'or" magnum vase
Limited edition of 50
H: 20.6" L: 16.1" W: 16.1"
60.06 lbs

Ref. 03375-6



Vase magnum ambre foncé
Édition limitée à 50 exemplaires
H : 52,5 cm L : 41 cm l : 41 cm
27,30 kg

Dark amber magnum vase
Limited edition of 50
H: 20.6" L: 16.1" W: 16.1"
60.06 lbs

Ref. 03375-5



Vase GM ambre

H : 33 cm L : 29 cm l : 25 cm
7,83 kg

Large amber vase

H: 13" L: 11.4" W: 9.8"
17.23 lbs

Ref. 03574

Vase appaloosa noir

Pièce numérotée

H : 33 cm L : 29 cm l : 25 cm
7,83 kg

Black appaloosa vase

Numbered piece

H: 13" L: 11.4" W: 9.8"
17.23 lbs

Ref. 03574-5



Vase ambre foncé

Edition limitée à 99 exemplaires
H : 33 cm L : 29 cm l : 25 cm
7,83 kg

Dark amber vase

Limited edition of 99

H: 13" L: 11.4" W: 9.8"
17.23 lbs

Ref. 03574-9





Vase GM bleu
Pièce numérotée
H : 33 cm L : 29 cm l : 25 cm
7,83 kg

Large blue vase
Numbered piece
H: 13" L: 11.4" W: 9.8"
17.23 lbs

Ref. 03574-7

Vase GM Ultraviolet
Pièce numérotée
H : 33 cm L : 29 cm l : 25 cm
7,83 kg

Large ultraviolet vase
Numbered piece
H: 13" L: 11.4" W: 9.8"
17.23 lbs

Ref. 03574-6



Vase blanc poudré
Édition limitée à 425 exemplaires
H : 33 cm L : 29 cm l : 25 cm
7,83 kg

White powdered vase
Limited edition of 425
H: 13" L: 11.4" W: 9.8"
17.23 lbs

Ref. 03574-4





Vase bleu
Pièce numérotée
H : 17 cm L : 12 cm l : 12 cm
1,2 kg

Blue vase
Numbered piece
H: 6.7" L: 4.7" W: 4.7"
2 lbs

Ref. 05213-4



Vase UV
Pièce numérotée
H : 17 cm L : 12 cm l : 12 cm
1,2 kg

UV vase
Numbered piece
H: 6.7" L: 4.7" W: 4.7"
2 lbs

Ref. 05213-2



Vase rouge
Pièce numérotée
H : 17 cm L : 12 cm l : 12 cm
1,2 kg

Red vase
Numbered piece
H: 6.7" L: 4.7" W: 4.7"
2 lbs

Ref. 05213-5



Vase ambre
Pièce numérotée
H : 17 cm L : 12 cm l : 12 cm
1,2 kg

Amber vase
Numbered piece
H: 6.7" L: 4.7" W: 4.7"
2 lbs

Ref. 05213-1



Mini vase ambre
H : 7 cm L : 5,8 cm l : 5,8 cm
0,1 kg

Amber mini-vase
H: 2.7" L: 2.3" W: 2.3"
0.3 lbs

Ref. 05158/C



Coupe ambre

H : 11,6 cm L : 30 cm l : 30 cm
2,50 kg

Amber bowl

H: 4.5" L: 11.8" W: 11.8"
5.50 lbs

Ref. 03579

Coupe ultraviolet

Pièce numérotée
H : 11,6 cm L : 30 cm l : 30 cm
2,50 kg

Ultraviolet bowl

Numbered piece
H: 4.5" L: 11.8" W: 11.8"
5.50 lbs

Ref. 03579-2



Coupe rouge

Pièce numérotée
H : 11,6 cm L : 30 cm l : 30 cm
2,50 kg

Red bowl

Numbered piece
H: 4.5" L: 11.8" W: 11.8"
5.50 lbs

Ref. 03579-3



Coupelle ambre

H : 7,5 cm L : 16 cm l : 16 cm
0,70 kg

Amber small bowl

H: 3" L: 6.3" W: 6.3"
1.54 lbs

Ref. 03228



Coupelle ultraviolet

H : 7,5 cm L : 16 cm l : 16 cm
0,70 kg

Ultraviolet small bowl

H: 3" L: 6.3" W: 6.3"
1.54 lbs

Ref. 03228-2

Coupelle rouge

Edition numérotée
H : 7,5 cm L : 16 cm l : 16 cm
0,70 kg

Red small bowl

Numbered edition
H: 3" L: 6.3" W: 6.3"
1.54 lbs

Ref. 03228-3





UNIVERS ANIMALIER
ANIMAL UNIVERSE

DECORATION
DECORATIVE OBJECTS

CARAFES / DECANTERS
FLACONS / PERFUME BOTTLES
VASES / VASES
CENTRE DE TABLE / CENTREPIECES

CARAFES • FLACONS

DECANTERS • PERFUME BOTTLES



Flacon à parfum prestige Couple de Papillons
Edition numérotée
H : 20 cm L : 13,5 cm l : 9,5 cm
160 ml - 0,7 kg

Couple of Butterflies prestige perfume bottle
Numbered edition
H: 7.9" L: 5.3" W: 3.7"
5.4 oz - 1.5 lbs

Ref : 05580-1



Flacon à parfum prestige l'Envol de Papillons
Edition numérotée
H : 22 cm L : 10 cm l : 10 cm
160 ml - 0,8 kg

Flight of Butterflies prestige perfume bottle
Numbered edition
H: 8.6" L: 3.9" W: 3.9"
5.4 oz - 1.9 lbs

Ref : 05518-1

CARAFES • FLACONS
DECANTERS • PERFUME BOTTLES



Carafe aigle
Edition numérotée
H : 35 cm L : 10 cm I : 9,5 cm
2,4 kg

Eagle decanter
Numbered edition
H: 13.7" L: 13.9" W: 3.8"
5.4 lbs

Ref. 05450



Carafe Plumes
Edition numérotée
H : 41,5 cm L : 14,5 cm I : 11 cm
3,5 kg

Feathers Decanter
Numbered edition
H: 16.3" L: 5.7" W: 4.3"
7.7 lbs

Ref. 05391



Carafe Cavalcade
Edition numérotée
H : 31 cm L : 9,5 cm I : 9,5 cm
2,5 Kg

Cavalcade Decanter
Numbered edition
H: 12.2" L: 3.5" W: 3.5"
5 lbs

Ref. 05623



Vase Prestige Cavalcade ambre
Édition limitée à 50 exemplaires
H : 86 cm Ø : 57 cm
62,3 kg

Amber cavalcade Prestige Vase
Limited edition of 50
H: 33.9" Ø: 22.4"
137.3 lbs

Ref : 05586

Socle en bronze patiné
Base in patinated bronze



Vase Prestige Cavalcade bleu-gris
Édition limitée à 50 exemplaires
H : 86 cm Ø : 57 cm
62,3 kg

Blue-grey cavalcade Prestige Vase
Limited edition of 50
H: 33.9" Ø: 22.4"
137.3 lbs

Ref : 05586-3

Socle en bronze blanc patiné
Base in patinated white bronze

CHEVAL

HORSE

Centre de Table Cavalcade bleu-gris

Édition limitée à 125 exemplaires

H : 31 cm L : 67 cm l : 42 cm

21,5 Kg

Blue-grey Cavalcade Centrepiece

Limited edition of 125

H: 12.2" L: 26.4" W: 16.5"

47 lbs

Ref. 05592-3



Socle en bronze blanc patiné
Base in patinated white bronze



Centre de Table Cavalcade ambre

Édition limitée à 125 exemplaires

H : 31 cm L : 67 cm l : 42 cm

21,5 Kg

Amber cavalcade Centrepiece

Limited edition of 125

H: 12.2" L: 26.4" W: 16.5"

47 lbs

Ref. 05592

Socle en bronze patiné
Base in patinated bronze

Vase Cheval bleu
Édition limitée à 175 exemplaires
H : 38 cm L : 33 cm I : 33 cm
13 kg

Blue Horse vase
Limited edition of 175
H: 15" L: 13" W: 13"
28.6 lbs

Ref. 05358-4



Vase Cheval gris bleu
Édition limitée à 500 exemplaires
H : 38 cm L : 33 cm I : 33 cm
13 kg

Gray blue Horse vase
Limited edition of 500
H: 15" L: 13" W: 13"
28.6 lbs

Ref. 05358-1



Vase Cheval ambre
Édition limitée à 500 exemplaires
H : 38 cm L : 33 cm I : 33 cm
13 kg

Amber Horse vase
Limited edition of 500
H: 15" L: 13" W: 13"
28.6 lbs

Ref. 05358





Vase magnum Cheval ambre
Édition limitée à 175 exemplaires
H : 50 cm L : 40 cm l : 40 cm
25,3 kg

Amber Horse magnum vase
Limited edition of 175
H: 19.7" L: 15.7" W: 15.7"
55.77 lbs

Ref. 05381



Vase magnum Cheval noir
Édition limitée à 175 exemplaires
H : 50 cm L : 40 cm l : 40 cm
25,3 kg

Black Horse magnum vase
Limited edition of 175
H: 19.7" L: 15.7" W: 15.7"
55.77 lbs

Ref. 05381-15



Vase magnum Cheval gris bleu,
3 têtes argentées
Édition limitée à 25 exemplaires
H : 50 cm L : 40 cm l : 40 cm
25,3 kg

*Grey blue horse magnum vase,
3 silvered heads
Limited edition of 25
H: 19.7" L: 15.7" W: 15.7"
55.77 lbs*

Ref. 05381-12



Vase magnum bleu 2 têtes dorées à la feuille d'or
Édition limitée à 25 exemplaires
H : 50 cm L : 40 cm l : 40 cm

*Blue magnum horse vase with 2 gilded heads
Limited edition of 25
H: 19" L: 15" W: 15"*

Ref. 05381-13

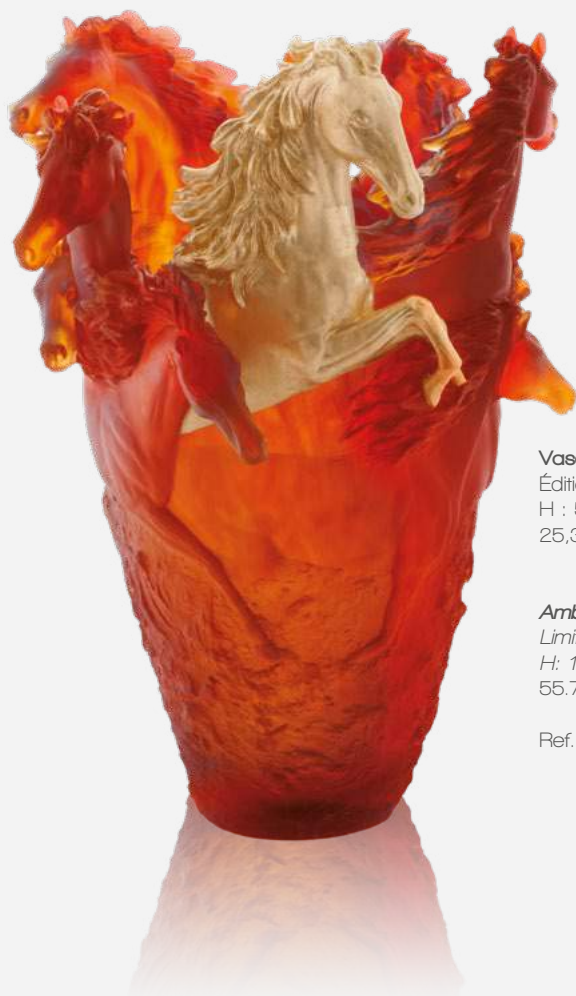

Vase magnum Cheval ambre, 3 têtes dorées
Édition limitée à 25 exemplaires
H : 50 cm L : 40 cm l : 40 cm
25,3 kg

*Amber horse magnum vase, 3 gilded heads
Limited edition of 25
H: 19.7" L: 15.7" W: 15.7"
55.77 lbs*

Ref. 05381-10



Vase Chevaux Allés gris
Édition limitée à 50 exemplaires
H : 87 cm L : 51 cm l : 51 cm
63,50 kg

Grey Stanislas Urn
Limited edition of 50
H: 34.2" L: 20" W: 20"
139,70 lbs

Ref. 03207-4



Vase Chevaux Allés ambre
Édition limitée à 50 exemplaires
H : 87 cm L : 51 cm l : 51 cm
63,50 kg

Amber Stanislas Urn
Limited edition of 50
H: 34.2" L: 20" W: 20"
139,70 lbs

Ref. 03207-3

SERPENT

SNAKE



Vase vert gris

Édition limitée à 888 exemplaires
H : 22 cm L : 21 cm l : 21 cm
5,5 Kg

Grey green snake vase

*Limited edition of 888
H: 8.6" L: 8.2" W: 8.2"
12 lbs*

Ref. 05249-2

Vase serpent vert jade
Édition limitée à 888 exemplaires
H : 22 cm L : 21 cm l : 21 cm
5,5 Kg

Jade green snake vase
Limited edition of 888
H: 8.6" L: 8.2" W: 8.2"
12 lbs

Ref. 05249-1



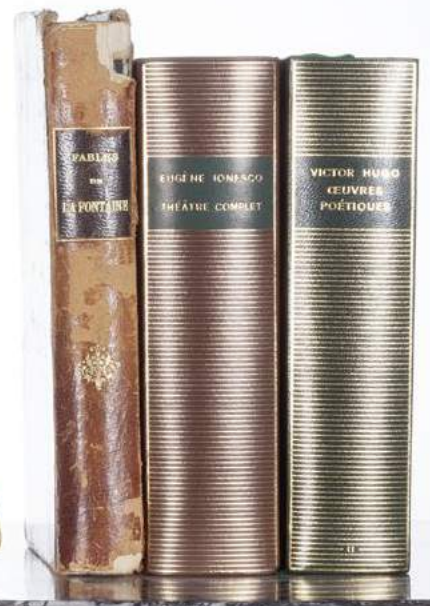

UNIVERS ANIMALIER
ANIMAL UNIVERSE
SCULPTURES



Aigle ambre gris

Édition limitée à 888 exemplaires
H : 24 cm L : 27,6 cm l : 18 cm
2,04 kg

Amber grey eagle

Limited edition of 888
H: 9.4" L: 10.8" W: 7.1"
4.49 lbs

Ref. 02676-1

Aigle PM gris

Édition numérotée
H : 15 cm L : 10 cm l : 6,5 cm
0,7 kg

Small grey eagle

Numbered edition
H: 5.9" L: 3.9" W: 2.5"
1.6 lbs

Ref. 05410



Aigle Pêcheur

Édition limitée à 1000 exemplaires
H : 21 cm L : 26 cm l : 18 cm
1,46 kg

Sea eagle

Limited edition of 1000
H: 8.2" L: 10.2" W: 7.1"
3.21 lbs

Ref. 03278



ÂNE • BUFFLE • CANARD & CANETONS

DONKEY • BUFFALO • DUCK & DUCKLINGS

Mini-âne gris ambre

H : 6 cm L : 6 cm l : 12 cm
0,4 kg

Grey amber mini-donkey

H: 2.3" L: 2.3" W: 4.7"
1 lbs

Ref. 05451/C



Buffle horoscope chinois

H : 7 cm L : 10,5 cm l : 6 cm
0,26 kg

Buffalo chinese horoscope

H: 2.7" L: 4.1" W: 2.3"
0.57 lbs

Ref. 03745



Canetons turquoise

H : 6,9 cm L : 7,5 cm l : 6 cm
0,33 kg

Turquoise ducklings

H: 2.7" L: 3" W: 2"
0.72 lbs

Ref. 02484-1



Canetons jaunes

H : 6,9 cm L : 7,5 cm l : 6 cm
0,33 kg

Yellow ducklings

H: 2.7" L: 3" W: 2"
0.72 lbs

Ref. 02484



Canard Colvert

H : 7,5 cm L : 13 cm l : 5 cm
0,4 kg

Mallard Duck

H: 3" L: 5.1" W: 2"
1 lbs

Ref. 05581



Chat ambre
H : 18 cm L : 28 cm l : 14 cm
8,30 kg

Amber cat
H: 7" L: 11" W: 5.5"
18.26 lbs

Ref. 02448

Chatons
H : 10,2 cm L : 10 cm l : 7,5 cm
0,72 kg

Kittens
H: 4" L: 3.9" W: 3"
1.58 lbs

Ref. 05026



Chat ambre-gris
H : 8 cm L : 11 cm l : 7 cm
0,68 kg

Amber-grey cat
H: 3.1" L: 4.3" W: 2.7"
1.50 lbs

Ref. 03931





Mini-chaton assis ambre
H : 4,5 cm L : 5 cm l : 2,6 cm
0,065 kg

Sitting amber mini-kitten
H: 1.7" L: 2" W: 1"
0.130 lbs

Ref. 05330/C



Mini-chaton joueur gris
H : 4,2 cm L : 5,6 cm l : 2,5 cm
0,065 kg

Playing grey mini-kitten
H: 1.6" L: 2.2" W: 1"
0.130 lbs

Ref. 05263-1/C



Mini-chaton joueur ambre
H : 4,2 cm L : 5,6 cm l : 2,5 cm
0,065 kg

Playing amber mini-kitten
H: 1.6" L: 2.2" W: 1"
0.130 lbs

Ref. 05263/C



Le Majestueux Bleu Gris
Edition limitée à 50 exemplaires
H : 48 cm L : 53 cm l : 16 cm
21 kg

Blue Grey "Le Majestueux"
Limited edition of 50
H : 19" L : 20.9" W : 6.3"
46.3 lbs

Ref : 05491-2

Le Majestueux ambre
Edition limitée à 50 exemplaires
H : 48 cm L : 53 cm l : 16 cm
21 kg

Amber "Le Majestueux"
Limited edition of 50
H : 19" L : 20.9" W : 6.3"
46.3 lbs

Ref : 05491





Cheval Fougueux Ambre Brun
Édition limitée à 500 exemplaires
H : 37 cm L : 28 cm l : 13 cm
4,2 kg

Amber Brown Spirited Horse
Limited edition of 500
H: 14.6" L: 11" W: 5.1"
9.2 lbs

Ref : 05585



Cheval Fougueux noir
Édition limitée à 500 exemplaires
H : 37 cm L : 28 cm l : 13 cm
4,2 kg

Black Spirited Horse
Limited edition of 500
H: 14.6" L: 11" W: 5.1"
9.2 lbs

Ref : 05585-1

Joueur de polo noir & blanc
Edition limitée à 1000 exemplaires
H : 26 cm L : 24 cm l : 9 cm
2,30 kg

Black & white polo player
Limited edition of 1000
H: 10.2" L: 9.4" W: 3.5"
5.06 lbs

Ref. 05013-2



Jockey noir et blanc
Edition limitée à 1000 exemplaires
H : 23 cm L : 27 cm l : 10 cm
2,63 kg

Black and white jockey
Limited edition of 1000
H: 9" L: 10.6" W: 3.9"
5.79 lbs

Ref. 02561-1



Tête de cheval andalou ambre gris

H : 23 cm L : 24 cm l : 10 cm
4,80 kg

Grey amber andalusian horse's head

H: 9" L: 9.4" W: 3.9"
10.56 lbs

Ref. 08023-1



Tête de cheval andalou ambre

H : 23 cm L : 24 cm l : 10 cm
4,80 kg

Amber andalusian horse's head

H: 9" L: 9.4" W: 3.9"
10.56 lbs

Ref. 08023



Tête de cheval arabe gris ambre

Pièce numérotée

H : 17,5 cm L : 15 cm l : 8,5 cm
1,150kg

Gey amber Arabian horse's head

Numbered piece

H: 6.8" L: 5.9" W: 3.3"
2 lbs

Ref. 05163

CHEVAL HORSE



Cheval musée Guimet

Edition limitée à 488 exemplaires
H : 17 cm L : 15 cm l : 10,5 cm
0,7kg

Cheval Guimet museum

Limited edition of 488
H: 6.7" L: 5.9" W: 4.1"
1.6 lbs

Ref. 03476

Love Horses

Edition limitée à 1000 exemplaires
H : 27 cm L : 45 cm l : 21 cm
10,6 kg

Limited edition of 1000
H: 10.6" L: 17.7" W: 8.3"
23.3 lbs

Ref. 03197





Mini-poulain ambre gris
H : 4,4 cm L : 5,8 cm l : 3,5 cm
0,060 kg

Amber gray mini-foal
H: 1.7" L: 2.3" W: 1.3"
1.23 lbs

Ref. 05333-2/C



Cheval horoscope
H : 11 cm L : 11,5 cm l : 3,5 cm
0,2 kg

Horse horoscope
H: 4.3" L: 4.5" W: 1.3"
0.5 lbs

Ref : 05561



Chèvre horoscope
H : 9 cm L : 10,5 cm l : 4 cm
0,2 kg

Goat horoscope
H: 3.5" L: 4.1" W: 1.7"
0.5 lbs

Ref : 05558



Chien horoscope
H : 9 cm L : 10 cm l : 4,2 cm
0,3 kg

Dog horoscope
H: 3,5" L: 3,9" W: 1,7"
0,6 lbs

Ref. 05506



Mini-chiot debout ambre
H : 4 cm L : 5,5 cm l : 2,6 cm
0,06 kg

Standing amber mini-puppy
H: 1.6" L: 2.1" W: 1"
1 lbs

Ref. 05387/C



Mini-chiot appaloosa
H : 4 cm L : 5 cm l : 4,5 cm
0,06 Kg

Appaloosa mini-puppy
H: 1.6" L: 2" W: 1.8"
0.1 lbs

Ref. 05262-2/C



Mini-chiot ambre
H : 4 cm L : 5 cm l : 4,5 cm
0,06 Kg

Amber mini-puppy
H: 1.6" L: 2" W: 1.8"
0.1 lbs

Ref. 05262-1/C



Golden retriever
H : 10,5 cm L : 9,8 cm l : 5,2 cm
0,3 kg

H: 4" L: 3.9" W: 2"
0.7 lbs

Ref. 03280



Chouette sur livre ambre gris
 H : 8,6 cm L : 5,8 cm l : 5 cm
 0,29 kg

Amber grey owl on book
 H: 3.4" L: 2.3" W: 2"
 0.64 lbs

Ref. 03465-1



Chouette Edwige verte ambre
 Pièce numérotée
 H : 15 cm L : 9 cm l : 11 cm
 1,35 Kg

Green amber Edwige owl
 Numbered piece
 H: 5.9" L: 3.5" W: 4.3"
 2 lbs

Ref. 05306

Cochon horoscope ambre
 H : 6,3 cm L : 8,5 cm l : 3,5 cm
 0,25 kg

Amber pig horoscope
 H: 2.5" L: 3.3" W: 1.4"
 0.55 lbs

Ref. 03392



Coq horoscope ambre vert
 H : 9,5 cm L : 8 cm l : 4,5 cm
 0,240 kg

Amber green horoscope rooster
 H: 3.7" L: 3.1" W: 1.8"
 0.53 lbs

Ref. 02693



CYGNE

SWAN

Cygne rose pâle

Édition limitée à 500 exemplaires
H : 24,8 cm L : 46 cm l : 22 cm
8,44 kg

Pale pink swan

Limited edition of 500
H: 9.7" L: 18.1" W: 8.6"
18.57 lbs

Ref. 03446



Couple de cygnes rose

H : 4,7 cm L : 6,2 cm l : 5,1 cm
0,09 kg

Pink swan couple

H: 1.8" L: 2.4" W: 2"
0.20 lbs

Ref. 02259-1



Vase boule Dragon

Édition limitée à 888 exemplaires
H : 24 cm L : 21 cm l : 21 cm
4,4 kg

Dragoon vase

Limited edition of 888
H: 9.4" L: 8.2" W: 8.2"
9 lbs

Ref. 05173

Dragon horoscope

H : 8 cm L : 9,5 cm l : 6,5 cm
0,2 kg

Dragon horoscope

H : 3.1" L: 3.7" W: 2.4"
0.5 lbs

Ref : 05559



Dragon Huit ambre

Pièce numérotée
H : 13 cm L : 13 cm l : 11,5 cm
0,620 kg

Amber dragoon eight

Numbered piece
H : 5.1" L: 5.1" W: 4.5"
1.36 lbs

Ref. 03437-1



ÉLÉPHANT

ELEPHANT



Mini-éléphant ambre gris
H : 4 cm L : 5,2 cm l : 4 cm
0,08 kg

Amber grey mini elephant
H: 1.6" L: 2" W: 1.6"
0.2 lbs

Ref. 05136/C



Éléphant ambre
H : 9,5 cm L : 12 cm l : 3,5 cm
0,28 kg

Amber elephant
H: 3.7" L: 4.7" W: 1.3"
0.62 lbs

Ref. 03917



Mini-éléphant bleu
H : 4 cm L : 5,2 cm l : 4 cm
0,08 kg

Blue mini elephant
H: 1.6" L: 2" W: 1.6"
0.2 lbs

Ref. 05136-2/C



Éléphant noir
H : 9,5 cm L : 12 cm l : 3,5 cm
0,28 kg

Black elephant
H: 3.7" L: 4.7" W: 1.3"
0.62 lbs

Ref. 03917-1



Mini-éléphant rose
H : 4 cm L : 5,2 cm l : 4 cm
0,08 kg

Pink mini elephant
H: 1.6" L: 2" W: 1.6"
0.2 lbs

Ref. 05136-1/C

FAUCON • GIRAFE • GRENOUILLE • HÉRON
FALCON • GIRAFFE • FROG • HERON

Faucon

Édition limitée à 1000 exemplaires
H : 22 cm L : 10,5 cm l : 10 cm
1,85 kg

Falcon

Limited edition of 1000
H: 8.6" L: 4.1" W: 3.9"
4.07 lbs

Ref. 02436



Mini girafe ambre

H : 6,5 cm L : 4 cm l : 5,5 cm
0,07 Kg

Amber mini giraffe

H: 2.5" L: 1.6" W: 2.2"
0.2 lbs

Ref. 05260-1/C



Painette turquoise

H : 4 cm L : 6,5 cm l : 5,5 cm
0,07 kg

Turquoise frog

H: 1.6" L: 2.5" W: 2.1"
0.14 lbs

Ref. 03281



Héron

H : 24,5 cm L : 11 cm l : 11 cm
1,06 kg

Heron

H: 9.6" L: 4.3" W: 4.3"
2.33 lbs

Ref. 02258

HIPPOPOTAME

HIPPOPOTAMUS

Hippopotame turquoise

H : 13,5 cm L : 18,5 cm l : 7 cm
2,20 kg

Turquoise hippopotamus

H: 5.3" L: 7.3" W: 2.7"
4.84 lbs

Ref. 02459



Presse-papier Hippopotame

H : 6 cm L : 16 cm l : 7 cm
0,55 kg

Hippopotamus Paperweight

H: 2.3" L: 6.3" W: 2.7"
1.21 lbs

Ref. 03774



Mini-hippopotame

H : 4 cm L : 7,2 cm l : 3,2 cm
0,80 Kg

Mini-hippopotamus

H: 1.6" L: 2.8" W: 1.2"
1.76 lbs

Ref. 05134/C



Maternity Koala

H : 11 cm L : 6,4 cm l : 4,3 cm
0,50 kg

Maternity Koala

H: 4.3" L: 2.5" W: 1.7"
1.10 lbs

Ref. 03489



Lapins horoscope chinois ambre gris

H : 7 cm L : 9,2 cm l : 6,2 cm
0,26 kg

Amber-grey Chinese horoscope rabbits

H: 2.7" L: 3.6" W: 2.4"
0.6 lbs

Ref. 05131

Maternity Lion

Pièce numérotée

H : 13 cm L : 28,5 cm l : 21 cm
3,58 kg

Maternity Lion

Numbered piece

H: 5.1" L: 11.2" W: 8.2"
7.88 lbs

Ref. 03496



Lion ambre

H : 7,8 cm L : 13 cm l : 8,5 cm
0,56 kg

Amber lion

H: 3" L: 5.1" W: 3.3"
1.23 lbs

Ref. 03318-1

Lion Sand ambre

Édition limitée à 500 exemplaires
H : 23 cm L : 33 cm l : 10 cm
5,5 kg

Amber Sand lion

Limited edition of 500
H: 9" L: 13" W: 3.9"
12.1 lbs

Ref. 05562

**Lion Sand noir**

Édition limitée à 500 exemplaires
H : 23 cm L : 33 cm l : 10 cm
5,5 kg

black Sand lion

Limited edition of 500
H: 9" L: 13" W: 3.9"
12.1 lbs

Ref. 05562-1



Mini-ourson ambre gris

H : 3,5 cm L : 5 cm l : 5 cm
0,08 Kg

Amber grey mini-bear cub

H: 1.4" L: 2" W: 2"
0.16 lbs

Ref. 05261-1/C



Ours polaire

H : 4,5 cm L : 10 cm l : 6,2 cm
0,35 kg

Polar bear

H: 1.8" L: 3.9" W: 2.4"
0.77 lbs

Ref. 03912



Ours et ourson

H : 10 cm L : 10 cm l : 9 cm
0,74 kg

Bear and bear cub

H: 3.9" L: 3.9" W: 3.5"
1.63 lbs

Ref. 02489



Grizzly ambre

Édition limitée à 1000 exemplaires
H : 36,5 cm L : 17 cm l : 14 cm
7,85 kg

Amber grizzly

Limited edition of 1000
H: 14.4" L: 6.7" W: 5.5"
17.27 lbs

Ref. 03140-1



Ours ambre foncé

H : 9,5 cm L : 13,4 cm l : 5 cm
0,68 kg

Dark amber bear

H: 3.7" L: 5.3" W: 2"
1.5 lbs

Ref. 05423

Panthère noire sur arbre émeraude
Pièce numérotée
H : 15 cm L : 15,5 cm l : 6,5 cm
0,81 kg

Black Panther on emerald tree
Numbered piece
H: 5.9" L: 6.1" W: 2.5"
1.78 lbs

Ref. 05027-4



Panthère ambre sur arbre vert
H : 15 cm L : 15,5 cm l : 6,5 cm
0,81 kg

Amber panther on green tree
H: 5.9" L: 6.1" W: 2.5"
1.78 lbs

Ref. 05027-2



Panthère ambre
H : 8,2 cm L : 21,5 cm l : 6 cm
0,94 kg

Amber panther
H: 3.2" L: 8.4" W: 2.3"
2.07 lbs

Ref. 02466-1



Panthère grise
Edition numérotée
H : 8,2 cm L : 21,5 cm l : 6 cm
0,94 kg

Grey panther
Numbered edition
H: 3.2" L: 8.4" W: 2.3"
2.07 lbs

Ref. 02466-2



PANTHÈRE
PANTHER



Panthère magnum ambre
Édition limitée à 1000 exemplaires
H : 20 cm L : 57 cm l : 14,5 cm
11,62kg

Amber magnum panther
Limited edition of 1000
H: 7.9" L: 22.4" W: 5.7"
25.6 lbs

Ref. 03596



Panthère magnum noire
Édition limitée à 1000 exemplaires
H : 20 cm L : 57 cm l : 14,5 cm
11,62 kg

Black magnum panther
Limited edition of 1000
H: 7.9" L: 22.4" W: 5.7"
25.6 lbs

Ref. 03596-1

Panthère ambre

Pièce numérotée

H : 13 cm L : 42 cm l : 10 cm

4 kg

Amber panther

Numbered piece

H: 5.1" L: 16.5" W: 3.9"

8.80 lbs

Ref. 03139-3



Panthère noire

Édition limitée à 1000 exemplaires

H : 13 cm L : 42 cm l : 10 cm

4 kg

Black Panther

Limited edition of 1000

H: 5.1" L: 16.5" W: 3.9"

8.80 lbs

Ref. 03139-4



PAON • PERRUCHES

PAON • BUDGERIGARS

Paon

H : 12 cm L : 14 cm l : 6 cm
0,32 kg

Peacock

H: 4.7" L: 5.5" W: 2.3"
0.70 lbs

Ref. 03976



Perruches

H : 23,5 cm L : 15 cm l : 14,5 cm
1,12 kg

Budgerigars

H: 9.2" L: 5.9" W: 5.7"
2.46 lbs

Ref. 02341



Couple de perruches bleu

H : 7,5 cm L : 10 cm l : 7 cm
0,26 kg

Blue budgerigars' couple

H: 3" L: 3.9" W: 2.7"
0.57 lbs

Ref. 02681



Couple de perruches ambre

H : 7,5 cm L : 10 cm l : 7 cm
0,26 kg

Amber budgerigars' couple

H: 3" L: 3.9" W: 2.7"
0.57 lbs

Ref. 02681-1



Couple de poissons ambre vert
H : 9 cm L : 7,3 cm l : 2,7 cm
0,11 kg

Amber green fish couple
H: 3.5" L: 2.9" W: 1"
0.24 lbs

Ref. 02656



Couple de poissons bleu jaune
H : 9 cm L : 7,3 cm l : 2,7 cm
0,11 kg

Blue yellow fish couple
H: 3.5" L: 2.9" W: 1"
0.24 lbs

Ref. 02656-1



Poisson ambre & anémone mauve PM
H : 5 cm L : 7 cm l : 5,4 cm
0,1 kg

Small amber fish and violet anemone
H: 2" L: 2.7" W: 2.1"
0.3 lbs

Ref. 05458-1/C

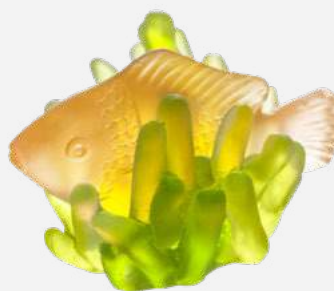

Poisson ambre & anémone verte PM
H : 5 cm L : 7 cm l : 5,4 cm
0,1 kg

Small amber fish and green anemone
H: 2" L: 2.7" W: 2.1"
0.3 lbs

Ref. 05458/C

Couple de carpes jaune marron
H : 6,8 cm L : 8,2 cm l : 4,7 cm
0,27 kg

Yellow brown carps couple
H: 2.7" L: 3.2" W: 1.8"
0.59 lbs

Ref. 03303



Couple de carpes gold
Édition limitée à 800 exemplaires
H : 25,8 cm L : 19,5 cm l : 14,5 cm
3,52 kg

Golden carps
Limited edition of 800
H: 10.1" L: 7.7" W: 5.7"
7.74 lbs

Ref. 03306

RAT • RENNE • RHINOCÉROS • SERPENT
RAT • REINDEER • RHINOCEROS • SNAKE

Rat horoscope
H : 9 cm L : 9 cm l : 5 cm
0,4 kg

Rat horoscope
H: 3.5" L: 3.5" W: 1.9"
0.8 lbs

Ref. 03688-1



Mini-renne ambre clair
H : 6 cm L : 6,2 cm l : 3 cm
0,1 kg

Light amber mini-reindeer
H: 2.3" L: 2.4" W: 1.2"
0.2 lbs

Ref. 05454/C

Mini-rhinocéros ambre gris
H : 4,5 cm L : 3,2 cm l : 6 cm
0,07 Kg

Amber grey mini-rhinocéros
H: 1.8" L: 1.2" W: 2.4"
0.2 lbs

Ref. 05259-1/C



Serpent horoscope
H : 7 cm L : 11 cm l : 6,5 cm

Snake horoscope
H : 2.7" L: 4.3" W: 2.4"

Ref : 05560

SINGE • TAUREAU
MONKEY • BULL



Les 3 singes de la sagesse
H : 7,5 cm L : 5,5 cm l : 4 cm
0,6 kg

The three wise monkeys
H: 3" L: 2.7" W: 1.6"
1.4 lbs

Ref. 05431/C

Singe à la pêche horoscope
H : 7 cm L : 3,5 cm l : 5,5 cm
0,2 kg

Monkey with peach horoscope
H: 2.7" L: 1.3" W: 2.1"
0.4 lbs

Ref : 05556



Taureau
H : 15,3 cm L : 26 cm l : 8,5 cm
1,82 kg

Bull
H: 6" L: 10.2" W: 3.3"
4 lbs

Ref. 02191



Tigre du Bengale ambre
Pièce numérotée
H : 15 cm L : 27,7 cm l : 7 cm
1,46 kg

Amber Bengal's tiger
Numbered piece
H: 5.9" L: 10.9" W: 2.7"
3.21 lbs

Ref. 03448

Tigre ambre
H : 12,5 cm L : 27 cm l : 10 cm
2,35 kg

Amber tiger
H: 4.9" L: 10.6" W: 3.9"
5.17 lbs

Ref. 05034



Tigre horoscope
H : 7 cm L : 13,5 cm l : 3 cm
0,3 kg

Tiger horoscope
H: 2.7" L: 5" W: 1.1"
0.6 lbs

Ref : 05586





Tigre du Bengale magnum gris
Édition limitée à 88 exemplaires
H : 30 cm L : 66 cm l : 18 cm
15,4 kg

Grey magnum Bengal's tiger
Limited edition of 88
H: 11.8" L: 26" W: 7"
34 lbs

Ref. 03447-4



Tigre du Bengale magnum noir
Édition limitée à 88 exemplaires
H : 30 cm L : 66 cm l : 18 cm
15,4 kg

Black magnum Bengal's tiger
Limited edition of 88
H: 11.8" L: 26" W: 7"
34 lbs

Ref. 03447-2

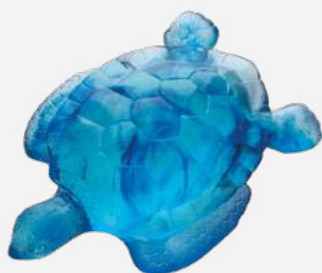

Tortue de mer bleue

H : 2,8 cm L : 11,6 cm l : 8,3 cm
0,31 kg

Blue sea turtle

H: 1.1" L: 4.5" W: 3.2"
0.68 lbs

Ref. 02691-5/C

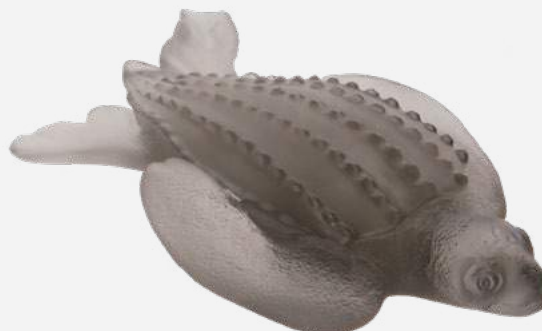

Tortue Luth

En collaboration avec Econick
H : 5 cm L : 16 cm l : 11,5 cm
0,6 kg

Leatherback sea turtle

In collaboration with Econick
H: 2" L: 6.3" W: 4.5"
1.3 lbs

Ref. 05656



Mini-tortue bleue

H : 1,9 cm L : 6,3 cm l : 5 cm
0,05 kg

Blue mini-turtle

H: 0.7" L: 2.5" W: 2"
0.11 lbs

Ref. 02690-5/C



Mini-tortue Turquoise

H : 1,9 cm L : 6,3 cm l : 5 cm
0,05 kg

Turquoise mini-turtle

H: 0.7" L: 2.5" W: 2"
0.11 lbs

Ref. 02690-10/C



Tortue de mer jaune

H : 2,8 cm L : 11,6 cm l : 8,3 cm
0,31 kg

Yellow sea turtle

H: 1.1" L: 4.5" W: 3.2"
0.68 lbs

Ref. 02691-1/C



Tortue de mer ambre

H : 2,8 cm L : 11,6 cm l : 8,3 cm
0,31 kg

Amber sea turtle

H: 1.1" L: 4.5" W: 3.2"
0.68 lbs

Ref. 02691/C



DESIGN
DESIGN

MASSAUD JEAN-MARIE

MASSAUD

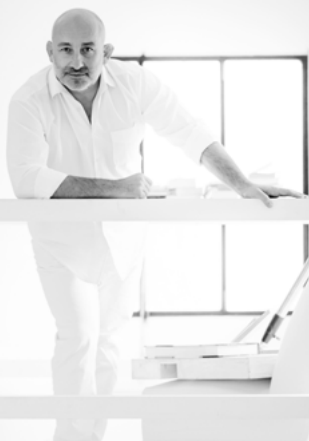

Depuis le début de sa carrière, Jean-Marie Massaud a travaillé sur un large éventail de projets, de l'architecture à l'objet, de la pièce unique à la série industrielle, de macro-environnements à des micro contextes. Des marques de référence telles que Axor, Cassina, Poliform, Toyota ont sollicité son habileté à conjuguer confort et élégance, zeitgeist et héritage, générosité et distinction.

Ses créations ont reçu de nombreux prix et beaucoup sont maintenant exposées dans les collections de design des principaux musées du monde : d'Amsterdam à Chicago, Londres, Paris et Zurich.

Pour Daum, Jean-Marie Massaud dessine le vase Kumara.

Au-delà de la pureté des lignes, la profondeur du cristal laisse deviner les signes cabalistiques insculpés dans la matière. Kumara est une pièce forte, un bloc de cristal animé d'une vie intérieure intense, au caractère énigmatique.

Since the beginning of his career, Jean-Marie Massaud has been working on an extensive range of works, stretching from architecture to objects, from one-off projects to serial ones, from macro environment down to micro contexts. Major brands such as Axor, Cassina, Poliform, Toyota have solicited his ability to mix comfort and elegance, zeitgeist and heritage, generosity and distinction.

His creations have received several awards, and many of his designs are now displayed in the design collections of the world's leading museums: from Amsterdam to Chicago, London, Paris and Zurich.

For Daum, Jean-Marie Massaud has designed the Kumara vase. Beyond the purity of the lines, the depth of the crystal invites us to decipher the cabalistic signs inscribed in the material. The Kumara is a powerful piece, a crystal block animated by an intense interior life, with an enigmatic character.



Vase Kumara

Édition limitée à 125 exemplaires

H : 30 cm L : 35 cm l : 12 cm

34 kg

Limited edition of 125

H: 11.8" L: 13.8" W: 4.7"

75 lbs

Ref. 03196



Vase Kumara Bleu Encre
Édition limitée à 25 exemplaires
H : 30 cm L : 35 cm l : 12 cm
34 kg

Ink Blue Kumara vase
Limited edition of 25
H: 11.8" L: 13.8" W: 4.7"
75 lbs

Ref. 03196-2

Vase Rythmes bleu
Edition numérotée
H : 28 cm L : 24 cm l : 24 cm
7 kg

Blue Rhythms vase
Numbered edition
H: 11" L: 9.4" W: 9.4"
15.4 lbs

Ref. 03549-2



Vase Rythmes vert olive
Edition numérotée
H : 28 cm L : 24 cm l : 24 cm
7 kg

Olive green Rhythms vase
Numbered edition
H: 11" L: 9.4" W: 9.4"
15.4 lbs

Ref. 03549-3



Vase Rythmes GM bleu
Edition numérotée
H : 51 cm Ø : 25 cm
16 kg

Large blue Rhythms vase
Numbered edition
H: 20" Ø: 9.8"
35.3 lbs

Ref. 03548-2

Vase Rythmes GM vert olive
Edition numérotée
H : 51 cm Ø : 25 cm
16 kg

Large olive green Rhythms vase
Numbered edition
H: 20" Ø: 9.8"
35.3 lbs

Ref. 03548-3



GHION CHRISTIAN

Christian Ghion



Christian Ghion est né en 1958 à Montmorency, France. À 28 ans, il fonde son propre studio de création avec Patrick Nadeau avec qui il signe de nombreux projets. Ils reçoivent le grand prix de la création de la ville de Paris en 1991. Leur collaboration durera une dizaine d'années, mais en 1998, c'est en solo qu'il décide de poursuivre son aventure.

Christian Ghion occupe très vite une place importante dans le paysage du design français et international. En 1999, il expose à la galerie Néotu. Il signe des créations pour des éditeurs de renom tels que Daum, Cappellini, Triade, Salviati, Sawaya & Moroni ou encore XO.

Il signe à nouveau pour Daum une extraordinaire collection, Sand, née de la volonté du designer d'explorer les mondes organiques et souvent invisibles.

Christian Ghion is a designer born in 1958, in Montmorency France. At the age of 28, he founded his own creation studio with Patrick Nadeau, and created many great projects. In 1991, the duo was bestowed with the "Grand Prix de la Création de la Ville de Paris". Their collaboration would last for a decade or so, before Ghion would decide to fly solo to pursue a different adventure.

Christian Ghion quickly makes a name for himself as a designer in the French and International Design scene. He has collaborated with many renowned brands, such as Daum, Cappellini, Triade, Salviati, Sawaya & Moroni on creating many projects.

The Maison Daum launches the Sand Collection in collaboration with Christian Ghion. This extraordinary collection was born from the designer's desire to explore the organic and often invisible worlds.



Vase Sand Grand Modèle

Édition limitée à 125 exemplaires
H : 36 cm L : 24,5 cm l : 19 cm
9,3 kg

Large Sand Vase

Limited edition of 125
H: 14.2" L: 9.6" W: 7.5"
20.5 lbs

Ref : 05593

Vase Sand Bleu
Édition limitée à 225 exemplaires
H : 30 cm L : 20 cm l : 21 cm
5,5 kg

Blue Sand Vase
Limited edition of 225
H: 11.8" L: 7.9" W: 8.3"
12.1 lbs

Ref : 05575-1



Vase Sand PM Bleu
H : 13 cm L : 7 cm l : 7 cm
0,8 kg

Blue Sand Vase
H: 5.1" L: 2.8" W: 2.8"
1.8 lbs

Ref : 05621

Vase Sand Violet
Édition limitée à 225 exemplaires
H : 30 cm L : 20 cm l : 21 cm
5,5 kg

Violet Sand Vase
Limited edition of 225
H: 11.8" L: 7.9" W: 8.3"
12.1 lbs

Ref : 05575



Vase Sand PM Vert Olive
H : 13 cm L : 7 cm l : 7 cm
0,8 kg

Olive Green Sand Vase
H: 5.1" L: 2.8" W: 2.8"
1.8 lbs

Ref : 05621-1

SAND

GHION CHRISTIAN



Centre de Table Sand Vert Olive
Édition limitée à 225 exemplaires
H : 13 cm Ø : 45 cm
7,2 kg

Olive Green Sand Centrepiece
Limited edition of 225
H: 5.1" Ø: 17.7"
15.9 lbs

Ref : 05591-1



Centre de Table Sand Bleu
Édition limitée à 225 exemplaires
H : 13 cm Ø : 45 cm
7,2 kg

Blue Sand Centrepiece
Limited edition of 225
H: 5.1" Ø: 17.7"
15.9 lbs

Ref : 05591

Coupe Sand Vert Olive
Édition limitée à 375
H : 11,5 cm Ø : 29 cm
2,9 kg

Olive Sand Green Bowl
Limited edition of 375
H: 4.5" Ø: 11.4"
6.4 lbs

Ref : 05574-1



Coupe Sand Violette
Édition limitée à 375
H : 11,5 cm Ø : 29 cm
2,9 kg

Violet Sand Bowl
Limited edition of 375
H: 4.5" Ø: 11.4"
6.4 lbs

Ref : 05574





Bougeoir Sand ambre
H : 27 cm Ø : 5 cm
0,8 kg

Amber Sand Candlestick
H: 10.6" Ø: 2"
1.8 lbs

Ref : 05622-2



Bougeoir Sand Bleu
H : 27 cm Ø : 5 cm
0,8 kg

Blue Sand Candlestick
H: 10.6" Ø: 2"
1.8 lbs

Ref : 05622

Photophore Sand Bleu
H : 9 cm Ø : 10 cm
0,4 kg

Blue Sand Candle holder
H: 3.5" Ø: 3.9"
0.9 lbs

Ref : 05619



Photophore Sand Ambre
H : 9 cm Ø : 10 cm
0,4 kg

Amber Sand Candle holder
H: 3.5" Ø: 3.9"
0.9 lbs

Ref : 05619-2



Flacon à parfum Sand Violet
H : 11,9 cm L : 4,7 cm l : 3 cm
30 ml, 0,1 kg

Violet Sand Perfume bottle
H: 4.7" L: 1.9" W: 1.2"
1 oz - 0.3 lbs

Ref : 05620/C



DÉCORATION
DECORATION



Martyn Lawrence Bullard est un architecte d'intérieur aux multiples récompenses, connu pour son style varié et ses intérieurs à la fois éclectiques, sophistiqués et accueillants. L'attention extraordinaire aux détails de Martyn et son engagement de qualité, lui ont valu une renommée internationale. Architectural Design l'a nommé l'un des 100 meilleurs designers d'intérieur au monde et a été nommé dans le top 25 des designers par le Hollywood Reporter, pour n'en citer que quelques-uns. Une collaboration entre le designer et Daum a débuté en 2015, lorsqu'il a créé des pièces exquises autour du thème "Adam et Eve". Le lustre Eden est né d'un désir profond de mettre en valeur la beauté du cristal Daum, mais également l'intensité et la profondeur de ses couleurs. Pour compléter la collection, un presse-papier qui rappelle la pomme d'Adam et Eve a été réalisé. Cette collection est sans aucun doute, un symbole éternel de beauté et de tentation.

Martyn Lawrence Bullard is a multi-award winning interior designer renowned for his broad range of styles and eclectic, yet sophisticated and inviting interiors. Martyn's extraordinary attention to detail and commitment to quality have won him international acclaim. He has been named by Architectural Design as one of the world's top 100 interior designers, and was dubbed the top 25 designers by The Hollywood Reporter, to name a few. A collaboration between the designer and Daum started in 2015, when he created exquisite pieces surrounding the Adam and Eve theme. The Eden chandelier was born from a desire to highlight the beauty of Daum crystal's intensely layered colour and depth. To complete the collection, a beautiful paperweight with an elegant gold leaf, recalling the bright rosy red apple of Adam and Eve was realized. This collection is without doubt, an eternal symbol of beauty and temptation.



Presse-papier Pomme

Edition numérotée

H : 8 cm L : 7 cm l : 6,5 cm
0,5 kg

Small Apple paperweight

Numbered edition

H: 3.1" L: 2.8" W: 2.6"
1.1 lbs

Ref : 05390/C



Pierre-Yves Rochon est l'un des plus grands architectes d'intérieur de la planète. Ses intérieurs sont toujours d'une extrême élégance, son univers est à la fois rassurant et apaisant.

Avec Daum, Pierre-Yves Rochon nous offre une collection d'oiseaux pleine de légèreté et de poésie.

Les Fiancés aux contours fluides et délicats sont des symboles puissants d'universalité et d'ouverture d'esprit. Ils nous touchent par leur douceur et leur tendresse.

Pierre-Yves Rochon is one of the greatest interior architects in the world. His interiors are always extremely elegant, his style is comforting and soothing.

With Daum, Pierre-Yves Rochon presents a bird collection full of lightness and poetry.

Love Birds, which contours are smooth and delicate, remain powerful symbols of universality and open-mindedness.

Their softness and tenderness are providing emotions.

Les Fiancés PM vert jaune

H : 3,5 cm L : 5 cm l : 3,5 cm
0,1 kg (chacun)



Small green yellow Love Birds

H: 1.3" L: 2" W: 0.8"
0.2 lbs (each)

Ref. 05384-20/C

Les Fiancés PM lilas framboise

H : 3,5 cm L : 5 cm l : 3,5 cm
0,1 kg (chacun)



Small lilac raspberry Love Birds

H: 1.3" L: 2" W: 0.8"
0.2 lbs (each)

Ref. 05384-21/C

Les Fiancés PM bleu rose

H : 3,5 cm L : 5 cm l : 3,5 cm
0,1 kg (chacun)



Small blue pink Love Birds

H: 1.3" L: 2" W: 0.8"
0.2 lbs (each)

Ref. 05384-22/C

ANGELOT • CHAUSSONS DE DANSE

ANGEL • BALLET SLIPPERS



Angelot

H : 9,5 cm L : 7,5 cm l : 5,5 cm
0,2 kg

Angel

H: 3.7" L: 3" W: 2.2"
0.5 lbs

Ref. 05570

Chausson de danse Etoile PM

Pièce numérotée

H : 12,5 cm L : 8,5 cm l : 13 cm
0,9 Kg

Ballet slipper small star

Numbered piece

H: 4.9" L: 3.3" W: 5.1"
2 lbs

Ref. 05479



Mini chausson de danse

H : 3 cm L : 4 cm l : 5 cm
0,03 kg

Mini-ballet slippers

H: 1.2" L: 1.6" W: 2"
0,1 lbs

Ref. 05366/C

CHEVAL À BASCULE

ROCKING HORSE



Cheval à bascule bleu

Edition numérotée

L : 15 cm l : 7 cm H : 14 cm

0,8 kg

Blue rocking horse

Numbered edition

L : 5,9" W : 2,8" H : 5,5"

1,9 lbs

Ref. 05509-1



Cheval à bascule ambre

Edition numérotée

L : 15 cm l : 7 cm H : 14 cm

0,8 kg

Amber rocking horse

Numbered edition

L : 5,9" W : 2,8" H : 5,5"

1,9 lbs

Ref. 05509



Cheval à bascule violet

Edition numérotée

L : 15 cm l : 7 cm H : 14 cm

0,8 kg

Purple rocking horse

Numbered edition

L : 5,9" W : 2,8" H : 5,5"

1,9 lbs

Ref. 05509-2



Macarons Citron

H : 5,5 cm L : 9 cm l : 6 cm
0,3 Kg

Citron Macarons

H: 2" L: 3.5" W: 2.4"
0.5 lbs

Ref. 05618-1



Macarons Rose

H : 5,5 cm L : 9 cm l : 6 cm
0,3 Kg

Rose Macarons

H: 2" L: 3.5" W: 2.4"
0.5 lbs

Ref. 05618

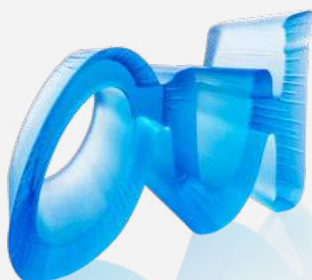

OUI

H : 5,6 cm L : 11 cm l : 4 cm
Poids : 0,2 kg

H: 2.2" L: 4.4" W: 1.6"
0.5 lbs

Ref. 05640



NON

H : 6 cm L : 14,5 cm l : 4 cm
Poids : 0,3 kg

H: 2.4" L: 5.7" W: 1.6"
0.7 lbs

Ref. 05652

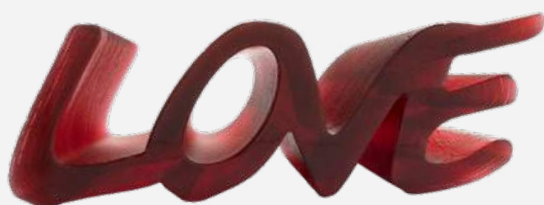

True Love

H : 5 cm L : 16,5 cm l : 3,5 cm
0,3 kg

*H: 2" L: 6.5" W: 1.3"
0.6 lbs*

Ref. 05594

True Love Bleu

H : 5 cm L : 16,5 cm l : 3,5 cm
0,3 kg

*H: 2" L: 6.5" W: 1.3"
0.6 lbs*

Ref. 05594-1

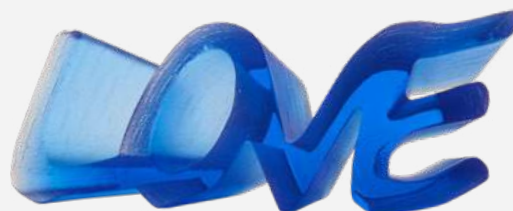

True Love Ultraviolet

H : 5 cm L : 16,5 cm l : 3,5 cm
0,3 kg

*H: 2" L: 6.5" W: 1.3"
0.6 lbs*

Ref. 05594-2



ORNEMENTS DE NOËL
CHRISTMAS ORNAMENTS



Flocon rouge

H : 6,5 cm L : 7,5 cm l : 2 cm
0,1 kg

Red snowflake

H: 2.5" L: 3" W: 0.8"
0.3 lbs

Ref. 05453-1/C



Flocon blanc

H : 6,5 cm L : 7,5 cm l : 2 cm
0,1 kg

White snowflake

H: 2.5" L: 3" W: 0.8"
0.3 lbs

Ref. 05453/C

Ornement de Noël rouge

H : 7 cm L : 7 cm l : 0,8 cm
0,07 kg

Red Christmas ornament

H: 2.8" L: 2.8" W: 0.3"
0.13 lbs

Ref. 05190-1/C



Sapin vert
H : 11,5 cm L : 8 cm l : 8 cm
0,4 kg

Green fir tree
H: 4.5" L: 3.1" W: 3.1"
0.9 lbs

Ref. 05455-2



Sapin blanc
H : 11,5 cm L : 8 cm l : 8 cm
0,4 kg

White fir tree
H: 4.5" L: 3.1" W: 3.1"
0.9 lbs

Ref. 05455



Bougie ambre senteur pomme de pin
H : 10 cm L : 9,5 cm l : 9,5 cm
0,5 kg

Amber pine cone scented candle holder
H: 3.9" L: 3.7" W: 3.7"
2 lbs

Ref. 05435-1

Recharge bougie pomme de pin
Pine cone candle refill
Ref. 05473

OURSONS RITZ

RITZ TEDDY BEARS



Ourson Ritz Paris PM ambre
Edition numérotée
H : 14 cm L : 9,6 cm l : 8 cm
0,9 kg

Small amber Ritz Paris teddy bear
Numbered edition
H: 5.5" L: 3.8" W: 3.1"
2 lbs

Ref. 05405-1



Ourson Ritz Paris PM blanc
Edition numérotée
H : 14 cm L : 9,6 cm l : 8 cm
0,9 kg

Small white Ritz Paris teddy bear
Numbered edition
H: 5.5" L: 3.8" W: 3.1"
2 lbs

Ref. 05405



Ourson Ritz Paris GM ambre
Edition numérotée
H : 28 cm L : 20 cm l : 16 cm
8,4 kg

Large amber Ritz Paris teddy
Numbered edition
H: 11" L: 7.9 W: 6.3"
18.5 lbs

Ref. 05467-1



Ourson Ritz Paris GM blanc
Edition numérotée
H : 28 cm L : 20 cm l : 16 cm
8,4 kg

Large white Ritz Paris teddy
Numbered edition
H: 11" L: 7.9 W: 6.3"
18.5 lbs

Ref. 05467



Doudours Twins bleu

Édition limitée à 375 exemplaires
H : 11 cm L : 10,5 cm l : 10,5 cm
1,3 kg

Blue Doudours Twins

Limited edition of 375
H: 4.3" L: 4.1" W: 4.1"
2.9 lbs

Ref : 05564-1



Doudours Twins rose

Édition limitée à 375 exemplaires
H : 11 cm L : 10,5 cm l : 10,5 cm
1,5 kg

Pink Doudours Twins

Limited edition of 375
H: 4.3" L: 4.1" W: 4.1"
2.9 lbs

Ref : 05564



Doudours ambre GM

Édition limitée à 375 exemplaires
H : 26 cm L : 22 cm l : 19,5 cm
10,5 kg

Large amber doudours

Limited edition of 375
H: 10.2" L: 8.7" W: 7.7"
23 lbs

Ref. 05365



Serge Mansau est internationalement reconnu dans l'industrie de la parfumerie où, depuis 1963, il crée les flacons des plus grands couturiers. Sculpteur, réalisateur et scénographe, il porte sur le monde un regard d'enfant.

Pour Daum, Serge Mansau crée ces figurines attachantes qui nous rappellent notre enfance. « Combien de nuits l'enfant a-t-il confié ses secrets dont seul, le Doudours confident attentif avait toutes les réponses ? »

Serge Mansau has gained international recognition as a designer in the perfume industry since 1963, where he creates bottles for the top couturiers. A sculptor, filmmaker and scenographer, he brings a child's vision to bear on the world.

For Daum, Serge Mansau creates figurines that remind us of our own childhood. « How many nights has the child told his secrets to his Doudours – this patient confidant who is the only one who has all the answers? »

Doudours bleu
Edition limitée à 375 exemplaires
H : 15 cm L : 11,5 cm l : 9 cm
1 kg

Blue Doudours
Limited edition of 375
H: 5.9" L: 4.5" W: 3.5"
2.2 lbs

Ref. 05271-2



Doudours noir
Edition limitée à 375 exemplaires
H : 15 cm L : 11,5 cm l : 9 cm
1 kg

Black Doudours
Limited edition of 375
H: 5.9" L: 4.5" W: 3.5"
2.2 lbs

Ref. 05271-4



Doudours gris
Edition limitée à 375 exemplaires
H : 15 cm L : 11,5 cm l : 9 cm
1 kg

Gray Doudours
Limited edition of 375
H: 5.9" L: 4.5" W: 3.5"
2.2 lbs

Ref. 05271-7





Doudours rose bonbon
Edition limitée à 375 exemplaires
H : 15 cm L : 11,5 cm l : 9 cm
1 kg

Candy Pink Doudours
Limited edition of 375
H: 5.9" L: 4.5" W: 3.15"
2.2 lbs

Ref. 05271-9

Doudours parme
Edition limitée à 375 exemplaires
H : 15 cm L : 11,5 cm l : 9 cm
1 kg

Violet Doudours
Limited edition of 375
H: 5.9" L: 4.5" W: 3.5"
2.2 lbs

Ref. 05271-6



Doudours jaune
Edition limitée à 375 exemplaires
H : 15 cm L : 11,5 cm l : 9 cm
1 kg

Yellow Doudours
Limited edition of 375
H: 5.9" L: 4.5" W: 3.15"
2.2 lbs

Ref. 05271-5





Mini-Doudours blanc
H : 8 cm L : 6 cm l : 5,5 cm
0,2 kg

White mini-doudours
H: 3.1" L: 2.4" W: 2.2"
0.4 lbs

Ref. 05364/C

Mini-Doudours bleu
H : 8 cm L : 6 cm l : 5,5 cm
0,2 kg

Blue mini-doudours
H: 3.1" L: 2.4" W: 2.2"
0.4 lbs

Ref. 05364-2/C



Mini-Doudours ambre
H : 8 cm L : 6 cm l : 5,5 cm
0,2 kg

Amber mini-doudours
H: 3.1" L: 2.4" W: 2.2"
0.5 lbs

Ref. 05364-1/C

Mini-Doudours rose
H : 8 cm L : 6 cm l : 5,5 cm
0,2 kg

Pink mini-doudours
H: 3.1" L: 2.4" W: 2.2"
0.4 lbs

Ref. 05364-3/C



Mini-Doudours jaune
H : 8 cm L : 6 cm l : 5,5 cm
0,2 kg

Yellow mini-doudours
H: 3.1" L: 2.4" W: 2.2"
0.5 lbs

Ref. 05364-5/C

Mini-Doudours parme
H : 8 cm L : 6 cm l : 5,5 cm
0,2 kg

Violet mini-doudours
H: 3.1" L: 2.4" W: 2.2"
0.5 lbs

Ref. 05364-6/C



PORTE-LIVRE • SYMBOLES • TOUR EIFFEL
 BOOKHOLDER • SYMBOLS • EIFFEL TOWER



Symbole Caducée

H : 13 cm (avec socle) L : 10 cm l : 6 cm
 0,6 kg

Caducée symbol

H: 5.1" (with base) L: 4.1" W: 2.4"
 1.4 lbs

Ref. 05571



Symbole Justice

H : 13 cm (avec socle) L : 10 cm l : 6 cm
 0,5 kg

Justice symbol

H: 5.1" (with base) L: 4.1" W: 2.4"
 1.2 lbs

Ref. 05572



Mezuzah feuille d'Olivier bleu

Edition numérotée
 H : 3 cm L : 14 cm l : 2,7 cm
 0,3 kg

Blue olive leaf Mezuzah

Numbered edition
 H: 1.2" L: 5.5" W: 1.1"
 0,6 lbs

Ref. 05311/C



Mezuzah feuille d'Olivier blanc

Edition numérotée
 H : 3 cm L : 14 cm l : 2,7 cm
 0,3 kg

White olive leaf Mezuzah

Numbered edition
 H: 1.2" L: 5.5" W: 1.1"
 0,6 lbs

Ref. 05311-1/C



Le Daum de Paris

Edition numérotée
 H : 20 cm L : 8 cm l : 8 cm
 3,4 kg

The Daum of Paris

Numbered edition
 H: 7.9" L: 3.1" W: 3.1"
 7.4 lbs

Ref. 05448-1

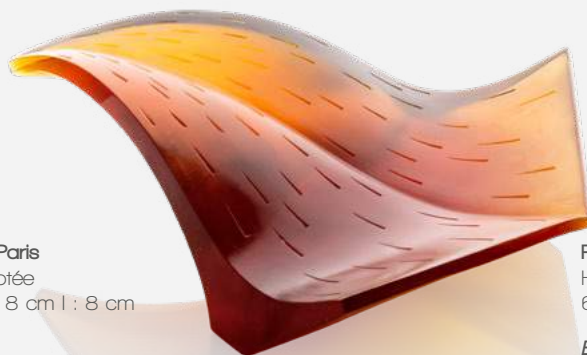

Porte Livre

H : 11 cm L : 37 cm l : 33 cm
 6,5 kg

Bookholder

H: 4.3" L: 14.6" W: 13"
 14.3 lbs

Ref. 05644



Little Happy Buddha
H : 7 cm L : 6 cm l : 6 cm
0,32 kg

Little Happy Buddha
H: 2.7" L: 2.3" W: 2.3"
0.70 lbs

Ref. 03955



Bouddha debout ambre
H : 10,7 cm L : 8,2 cm l : 8,2 cm
0,57 kg

Standing amber Buddha
H: 4.2" L: 3.2" W: 3.2"
1.25 lbs

Ref. 03299

Happy Buddha ambre
H : 6,5 cm L : 11 cm l : 6,5 cm
0,63 kg

Amber happy Buddha
H: 2.5" L: 4.3" W: 2.5"
1,39 lbs

Ref. 06390



Petit Buddha ocre
Édition limitée à 488 exemplaires
H : 16 cm L : 7,5 cm l : 7 cm
0,88 kg

Little ochre Buddha
Limited edition of 488
H: 6.3" L: 3" W: 2.7"
1.93 lbs

Ref. 03395-1



DIVINITÉ - GANESH
 DIVINITY - GANESHA



Ganesh blessing

Édition limitée à 488 exemplaires
 H : 21 cm L : 13,5 cm l : 12,5 cm
 2,74 kg

Ganesh blessing

Limited edition of 488
 H: 8.2" L: 5.3" W: 4.9"
 6.03 lbs

Ref. 03925

Ganesh

Édition limitée à 888 exemplaires
 H : 14 cm L : 10,5 cm l : 9 cm
 0,86 kg

Ganesh

Limited edition of 488
 H: 5.5" L: 4.1" W: 3.5"
 1.89 lbs

Ref. 03795



Ganesha ambre foncé

H : 10,2 cm L : 4,8 cm l : 4,4 cm
 0,23 kg

Dark amber Ganesha

H: 4" L: 1.9" W: 1.7"
 0.51 lbs

Ref. 01282-3



Coffret 3 Ganesh musiciens blancs

H : 9 cm L : 5,5 cm l : 4,5 cm
 0,7 kg

Set of 3 white Ganesh musicians

H: 3.5" L: 2" W: 1.8"
 1.5 lbs

Ref. 05457/C



Ganesha XL

Édition limitée à 88 exemplaires
H : 58 cm L : 33,5 cm l : 21,5 cm
35 kg

Ganesha XL

Limited edition of 88
H: 22.8" L: 13.2" W: 8.4"
70.54 lbs

Ref. 05207

Ganesha

Édition limitée à 1000 exemplaires
H : 54 cm L : 11 cm l : 8,5 cm
1,25 kg

Ganesha

Limited edition of 1000
H: 21.2" L: 4.3" W: 3.3"
2.75 lbs

Ref. 03443





Musicien Tabla
H : 9 cm L : 5,5 cm l : 4,5 cm
0,2 kg

Tabla musician
H: 3.5" L: 2" W: 1.8"
0.5 lbs

Ref. 05208/C



Musicien Veena
H : 9 cm L : 5,5 cm l : 4,5 cm
0,2 kg

Veena musician
H: 3.5" L: 2" W: 1.8"
0.5 lbs

Ref. 05210/C



Musicien Dholak
H : 9 cm L : 5,5 cm l : 4,5 cm
0,2 kg

Dholak musician
H: 3.5" L: 2" W: 1.8"
0.5 lbs

Ref. 05209/C

Mini-Ganesh bleu

H : 4,5 cm L : 5,2 cm l : 3,3 cm
0,100 Kg

Blue mini-Ganesh

H: 1.8" L: 2" W: 1.3"
0.22 lbs

Ref. 05288/C



Mini-Ganesh orange

H : 4,5 cm L : 5,2 cm l : 3,3 cm
0,100 Kg

Orange mini-Ganesh

H: 1.8" L: 2" W: 1.3"
0.22 lbs

Ref. 05288-5/C

Mini-Ganesh framboise

H : 4,5 cm L : 5,2 cm l : 3,3 cm
0,100 Kg

Framboise mini-Ganesh

H: 1.8" L: 2" W: 1.3"
0.22 lbs

Ref. 05288-9/C



Mini-Ganesh ultraviolet

H : 4,5 cm L : 5,2 cm l : 3,3 cm
0,100 Kg

Ultraviolet mini-Ganesh

H: 1.8" L: 2" W: 1.3"
0.22 lbs

Ref. 05288-1/C

Lakshmi

Édition limitée à 888 exemplaires
H : 15 cm L : 10 cm l : 5 cm
0,96 kg

Lakshmi

Limited edition of 888
H: 5.9" L: 3.9" W: 2"
2.11 lbs

Ref. 03926



Lakshmi XL

Édition limitée à 88 exemplaires
H : 56 cm L : 35 cm l : 25,5 cm
24 kg

Lakshmi XL

Limited edition of 88
H: 22" L: 13.8" W: 10"
52.8 lbs

Ref. 05322



Vishnu XL
Édition limitée à 88 exemplaires
H : 54 cm L : 29 cm l : 14,5 cm
7,2 kg

Vishnu XL
Limited edition of 88
H: 21.2" L: 11.4" W: 5.7"
15.8 lbs

Ref. 05284

HOROSCOPE CHINOIS

CHINESE HOROSCOPE



Cheval horoscope

H : 11 cm L : 11,5 cm l : 3,5 cm
0,2 kg

Horse horoscope

H: 4.3" L: 4.5" W: 1.3"
0.5 lbs

Ref. 05561



Chèvre horoscope

H : 9 cm L : 10,5 cm l : 4 cm
0,2 kg

Goat horoscope

H: 3.5" L: 4.1" W: 1.7"
0.5 lbs

Ref : 05558



Tigre horoscope

H : 7 cm L : 13,5 cm l : 3 cm
0,3 kg

Tiger horoscope

H: 2.7" L: 5" W: 1.1"
0.6 lbs

Ref. 05566



Buffle horoscope

H : 7 cm L : 10,5 cm l : 6 cm
0,26 kg

Buffalo horoscope

H: 2.7" L: 4.1" W: 2.3"
0.57 lbs

Ref. 03745



Cochon horoscope ambre

H : 6,3 cm L : 8,5 cm l : 3,5 cm
0,25 kg

Amber pig horoscope

H: 2.5" L: 3.3" W: 1.4"
0.55 lbs

Ref. 03392



Chien horoscope

H : 9 cm L : 10 cm l : 4,2 cm
0,3 kg

Dog horoscope

H: 3.5" L: 3.9" W: 1.7"
0.6 lbs

Ref. 05506



Coq horoscope ambre vert
H : 9,5 cm L : 8 cm l : 4,5 cm
0,240 kg

Amber green rooster horoscope
H: 3.7" L: 3.1" W: 1.8"
0.53 lbs

Ref. 02693



Rat horoscope
H : 9 cm L : 9 cm l : 5 cm
0,4 kg

Rat horoscope
H: 3.5" L: 3.5" W: 1.9"
0.8 lbs

Ref. 03688-1



Lapins horoscope chinois ambre-gris
H : 7 cm L : 9,2 cm l : 6,2 cm
0,26 kg

Amber-grey rabbits horoscope
H: 2.7" L: 3.6" W: 2.4"
0.6 lbs

Ref. 05131



Dragon horoscope
H : 8 cm L : 9,5 cm l : 6,5 cm
0,2 kg

Dragon horoscope
H: 3.1" L: 3.7" W: 2.4"
0.4 lbs

Ref. 05559



Singe à la pêche horoscope
H : 7 cm L : 3,5 cm l : 5,5 cm
0,2 kg

Monkey with peach horoscope
H: 2.7" L: 1.3" W: 2.1"
0.4 lbs

Ref : 05556



Serpent horoscope
H : 7 cm L : 11 cm l : 6,5 cm
0,2 kg

Snake horoscope
H: 2.7" L: 4.3" W: 2.4"
0.4 lbs

Ref : 05560



ARCHITECTURE D'INTÉRIEUR
INTERIOR DESIGN

TABLE IMPRÉVISIBLE

IMPREVISIBLE TABLE

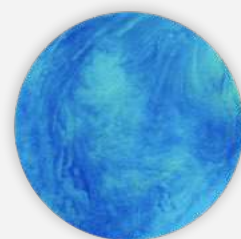

Aqua



Solaire

Table d'appoint Imprévisible

Plateau en cristal (feuilleté avec un verre trempé) sur structure en acier poli miroir

Editions numérotées

Aqua, bleu vert - Ref. 05577 ou Solaire, ambre rose, Ref. 05577-1

Ø : 61 cm - H : 50 cm

25,5 kg

Imprevisible side table

"Pâte de cristal" panel (laminated with toughened glass) on a bright polished stainless steel structure

Numbered editions

Aqua, blue green - Ref. 05577, or Solar, amber pink - Ref. 05577-1

Ø : 24" - H : 19.6"

56.2 lbs



TABLE VÉGÉTALE

VEGETAL TABLE

Table Végétal gris-bleu 6 éléments / Blue grey 6-piece Vegetal table Ref. 05392-2
Table Végétal gris-bleu 3 éléments / Blue grey 3-piece Vegetal table Ref. 05392-3



Table Végétale 6 éléments

Existe également avec 3 panneaux supérieurs uniquement

Éditions numérotées

Structure en acier inoxydable poli brillant

Plateau en verre trempé extra-blanc

Pied : H : 75 cm Ø 100 cm, 125 kg

Plateau vendu séparément ; disponible en Ø 140 cm (Ref. 05501) / Ø 150 cm (Ref. 05502) / Ø 160 cm (Ref.05503)

6-piece Vegetal Table

Also available with solely 3 upper panel

Numbered editions

Bright polished stainless steel structure

Extra-white toughened glass table top

Crystal stand: H: 29.5" Ø: 39.4", 275.6 lbs

Table top sold separately: available in Ø: 55.1" (Ref. 05501) / Ø: 59" (Ref. 05502) / Ø: 63" (Ref. 05503)



Table Végétal ambre 6 éléments / Amber 6-piece Vegetal table Ref. 05392-1

Table Végétal ambre 3 éléments / Amber 3-piece Vegetal table Ref. 05392



TABLE VÉGÉTALE

VEGETAL TABLE

Gris bleu / Blue gray Ref. 05662-1



Bout de canapé Végétal

Édition numérotée

H : 50 cm Poids : 47,5 kg

Plateau en verre trempé : Ø : 60 cm

Pied : Ø bas : 52,5 cm Ø haut : 42,5 cm H : 49 cm

Vegetal Side Table

Numbered edition

H: 19.7" Weight: 103.6 lbs

Toughened glass table top: Ø: 23.6"

Crystal stand: Base Ø: 20.5" Top Ø: 16.5" H: 19.3"



Ambre / Amber Ref. 05662

TABLE VÉGÉTALE

VEGETAL TABLE

Table basse Grand Modèle Végétale

Édition numérotée

H : 50 cm Poids : 129 kg

Plateau en verre trempé : L : 180 cm l : 90 cm

Pied : Ø bas : 52,5 cm Ø haut : 42,5 cm H : 49 cm

Large Vegetal Coffee Table

Numbered edition

H: 19.7" Weight: 284.4 lbs

Toughened glass table top: L: 70.9" W: 35.4"

Crystal stand: Base Ø: 20.5" Top Ø: 16.5" H: 19.3"



Bicolore / Bicolour Ref : 05661-2



Gris Bleu / Blue Grey Ref : 05661-1



Ambre / Amber Ref : 05661





TABLE VÉGÉTALE

VEGETAL TABLE

Gris-bleu / Blue grey Ref. 05406-1



Bout de canapé Végétal

Édition numérotée

H : 50 cm Poids : 47,5 kg

Plateau en verre trempé : Ø : 90 cm

Pied : Ø bas : 52,5 cm Ø haut : 42,5 cm H : 49 cm

Vegetal Side Table

Numbered edition

H: 19.7" Weight: 103.6 lbs

Toughened glass table top: Ø: 35.4"

Crystal stand: Base Ø: 20.5" Top Ø: 16.5" H: 19.3"



Ambre / Amber Ref. 05406



APPLIQUE VÉGÉTALE

VEGETAL WALL LAMP



Applique végétale ambre
Edition numérotée
H : 32 cm L : 31 cm l : 16 cm
3,6 kg

Amber floral wall lamp
Numbered edition
H: 12.6" L: 12.2" W: 6.3"
8 lbs

Ref. 05495

Applique végétale blanche
Edition numérotée
H : 32 cm L : 31 cm l : 16 cm
3,6 kg

White vegetal wall lamp
Numbered edition
H: 12.6" L: 12.2" W: 6.3"
8 lbs

Ref. 05495-1



Applique végétale gris bleu
Edition numérotée
H : 32 cm L : 31 cm l : 16 cm
3,6 kg

Blue grey vegetal wall lamp
Numbered edition
H: 12.6" L: 12.2" W: 6.3"
8 lbs

Ref. 05495-2





APPLIQUE MONSTERA

MONSTERA WALL LAMP

Ilidio Fobba



Applique blanche grand modèle

Pièce numérotée
H : 21 cm L : 52 cm l : 46 cm
10,2 Kg

Large white wall lamp

Numbered piece
H: 8.2" L: 20.4" W: 18.1"
22 lbs

Fixation courte *short fixture*
Ref. 05319-1



Applique grise grand modèle

Pièce numérotée
H : 21 cm L : 52 cm l : 46 cm
10,2 Kg

Large grey wall lamp

Numbered piece
H: 8.2" L: 20.4" W: 18.1"
22 lbs

Fixation courte *short fixture*
Ref. 05319-2



Applique verte grand modèle

Pièce numérotée
H : 21 cm L : 52 cm l : 46 cm
10,2 Kg

Large green wall lamp

Numbered piece
H: 8.2" L: 20.4" W: 18.1"
22 lbs

Fixation courte *short fixture*
Ref. 05319

Appliques GM : Base lumineuse en laiton, dorure mat 24 carats, inclinaison possible sur un axe vertical, rotation de gauche à droite à 20° de chaque côté.
Large wall lamps: Brass light base, golden finish 24 carats, possible to tilt on a vertical axis, 20° rotation from left to right on each side.



Applique blanche petit modèle

Pièce numérotée
H : 14 cm L : 33 cm l : 29,5 cm
3,5 Kg

Small white wall lamp

Numbered piece
H: 5.5" L: 13" W: 11.6"
7 lbs

Fixation courte *short fixture*
Ref. 05321-1



Applique grise petit modèle

Pièce numérotée
H : 14 cm L : 33 cm l : 29,5 cm
3,5 Kg

Small grey wall lamp

Numbered piece
H: 5.5" L: 13" W: 11.6"
7 lbs

Fixation courte *short fixture*
Ref. 05321-2



Applique verte petit modèle

Pièce numérotée
H : 14 cm L : 33 cm l : 29,5 cm
3,5 Kg

Small green wall lamp

Numbered piece
H: 5.5" L: 13" W: 11.6"
7 lbs

Fixation courte *short fixture*
Ref. 05321



Feuille murale verte grand modèle

Pièce numérotée
H : 21 cm L : 52 cm l : 46 cm
10,2 Kg

Large green wall leaf

Numbered piece
H: 8.2" L: 20.4" W: 18.1"
22 lbs

Fixation courte *short fixture*
Ref. 05298



Feuille murale verte petit modèle

Pièce numérotée
H : 14 cm L : 33 cm l : 29,5 cm
3,5 Kg

Small green wall leaf

Numbered piece
H: 5.5" L: 13" W: 11.6"
7 lbs

Fixation courte *short fixture*
Ref. 05276-040

Fixation longue *long fixture*
Ref. 05276-070



Feuille murale verte ambre petit modèle

Pièce numérotée
H : 14 cm L : 33 cm l : 29,5 cm
3,5 Kg

Small green amber wall leaf

Numbered piece
H: 5.5" L: 13" W: 11.6"
7 lbs

Fixation courte *short fixture*
Ref. 05276-140

Fixation longue *long fixture*
Ref. 05276-170



Grandes feuilles murales : Base circulaire en laiton, inclinaison possible sur un axe vertical , rotation de 30° de gauche à droite, vernis polymat.
Large wall leaves: Brass base possible to tilt on a vertical axis, 30° rotation from left to right, polimatt varnish.

Petites feuilles murales : Base circulaire en laiton, inclinaison possible sur un axe vertical, rotation de 30° de gauche à droite, rotule à 360° qui permet d'orienter la feuille de différentes manières, vernis polymat.

Small wall leaves: Brass base, possible to tilt on a vertical axis, 30° left to right rotation, 360° rotation allowing the user to direct the leaf in different ways, polimatt varnish.



Feuille murale blanche grand modèle

Pièce numérotée
H : 21 cm L : 52 cm l : 46 cm
10,2 Kg

Large white wall leaf

Numbered piece
H: 8.2" L: 20.4" W: 18.1"
22 lbs

Fixation courte *short fixture*
Ref. 05298-1



Feuille murale grise grand modèle

Pièce numérotée
H : 21 cm L : 52 cm l : 46 cm
10,2 Kg

Large grey wall leaf

Numbered piece
H: 8.2" L: 20.4" W: 18.1"
22 lbs

Fixation courte *short fixture*
Ref. 05298-2



Feuille murale blanche petit modèle

Pièce numérotée
H : 14 cm L : 33 cm l : 29,5 cm
3,5 Kg

Small white wall leaf

Numbered piece
H: 5.5" L: 13" W: 11.6"
7 lbs

Fixation courte *short fixture*
Ref. 05276-240

Fixation longue *long fixture*
Ref. 05276-270

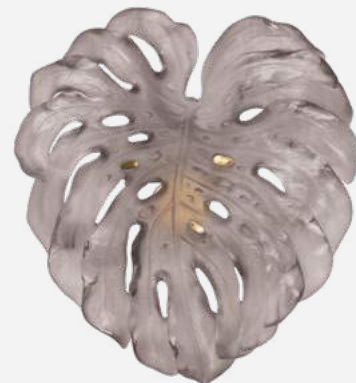

Feuille murale grise petit modèle

Pièce numérotée
H : 14 cm L : 33 cm l : 29,5 cm
3,5 Kg

Small grey wall leaf

Numbered piece
H: 5.5" L: 13" W: 11.6"
7 lbs

Fixation courte *short fixture*
Ref. 05276-340

Fixation longue *long fixture*
Ref. 05276-370



FEUILLE BORNEO

BORNEO WALL LEAF

Silvia Fobba

Feuille murale verte petit modèle

Pièce numérotée
H : 34,5 cm L : 29 cm I : 20 cm
3 kg

Small green wall leaf

Numbered piece
H: 13.6" L: 11.4" W: 7.9"
6.5 lbs

Fixation courte *short fixture*
Ref. 05529-040

Fixation longue *long fixture*
Ref. 05529-070



Feuille murale blanche petit modèle

Pièce numérotée
H : 34,5 cm L : 29 cm I : 20 cm
3 kg

Small white wall leaf

Numbered piece
H: 13.6" L: 11.4" W: 7.9"
6.5 lbs

Fixation courte *short fixture*
Ref. 05529-140

Fixation longue *long fixture*
Ref. 05529-170



Feuille murale verte grand modèle

Pièce numérotée
H : 60 cm L : 45 cm I : 20 cm
10 Kg

Large green wall leaf

Numbered piece
H: 23.7" L: 17.7" W: 7.9"
22 lbs

Fixation courte *short fixture*
Ref. 05517



Feuille murale blanche grand modèle

Pièce numérotée
H : 60 cm L : 45 cm I : 20 cm
10 Kg

Large white wall leaf

Numbered piece
H: 23.7" L: 17.7" W: 7.9"
22 lbs

Fixation courte *short fixture*
Ref. 05517-1

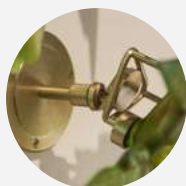

Fixation longue *long fixture*



Fixation courte *short fixture*

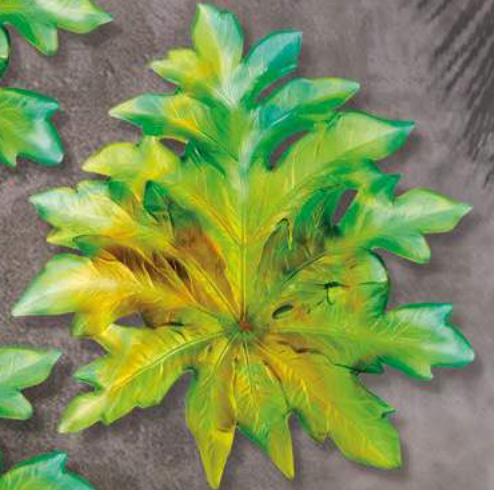



Lustre Eden

Edition limitée à 50 exemplaires
H : 102 cm L : 56 cm l : 56 cm
40 kg

Eden chandelier

Limited edition of 50
H: 40.1" L: 22" W: 22"
88.2 lbs

Ref. 05389-1



Lustre Eden Reptile

Edition limitée à 8 exemplaires
H : 102 cm L : 56 cm l : 56 cm
42 kg

Reptile Eden chandelier

Limited edition of 8
H: 40.1" L: 22" W: 22"
92.6 lbs

Ref. 05389

Structure en laiton poli verni : 1 tige centrale et 5 anneaux (Ø Max. : 36 cm, Ø Min. : 20 cm)
64 feuilles en pâte de cristal vert clair : 8 feuilles GM (L : 18 cm) et 56 feuilles PM (L : 17 cm)
Feuille de la pomme en bronze doré ; serpent en bronze patiné
13 ampoules halogènes (E14 CE ; E12 USA ; ampoules non fournies)

Polished lacquered brass structure: 1 central rod & 5 rings (Max. Ø: 14.2", min. Ø: 20 cm - 7.9")
64 light green "pâte de cristal" leaves: 8 large leaves (L: 7.1") and 56 small leaves (L: 6.7")
Apple leaf in gilded bronze; serpent in patinated bronze
13 Halogen bulbs (E14 socket for CE; E12 socket for USA; bulbs not provided)



Lustre Eden blanc

Edition numérotée

H : 102 cm L : 56 cm l : 56 cm

39 kg

White Eden chandelier

Numbered edition

H: 40.1" L: 22" W: 22"

86 lbs

Ref. 05489

- Structure en laiton nickelé puis chromé
- 65 feuilles en pâte de cristal blanc : 15 feuille GM (17,8 cm) et 50 feuilles PM (L : 16,5 cm)
- Hauteur totale = 102 cm (cache-piton fourni)
- 12 ampoules flammes E14 halogène 230V 30W 405 lumen warm white 2700K
- Homologation CE

- *Nickelled and chrome-plated brass structure*
- *65 white "pâte de cristal" leaves (L: 7") and 50 small leaves (L: 6.5")*
- *Total height = 40.2" (ceiling rose provided)*
- *12 E14 halogen flame bulbs 230V 30W 405 lumen warm white 2700K*
- *CE certified*

SUSPENSION ROSE PASSION

EDEN CHANDELIER



Suspension blanche & rouge
Édition limitée à 175 exemplaires
H : 165 cm L : 40 cm l : 40 cm
20,5 Kg

White & red hanging lamp
Limited edition of 175
H: 65" L: 15.7" W: 15.7"
45 lbs

Ref. 05317-1

SUSPENSION ROSE PASSION
ROSE PASSION HANGING LAMP



Suspension verte & rose
Édition limitée à 225 exemplaires
H : 165 cm L : 40 cm l : 40 cm
20,5 Kg

Green & pink hanging lamp
Limited edition of 225
H: 65" L: 15.7" W: 15.7"
45 lbs

Ref. 05317



LUSTRE ROSE PASSION
ROSE PASSION CHANDELIER



Lustre XXL blanc & rouge
Édition limitée à 8 exemplaires
H : 208 cm L : 108 cm l : 108 cm
250 Kg

XXL white & red Chandelier
Limited edition of 8
H: 81.9" L: 42.5" W: 42.5"
551 lbs

Ref. 05316

LAMPE RÉSONANCE
RESONANCE LAMP



Bleu Encre - *Ink Blue*
Ref. 05552-1



Vert Boréal - *Boreal Green*
Ref. 05552

Lampe Résonance
Editions numérotées
Ø : 25 cm (Abat-jour) - H : 43 cm
6 kg

Résonance Lamp
Numbered editions
Ø: 9.8" (Lamp-shade) - H: 16.4"
13.2 lbs

LAMPE RÉSONANCE
RESONANCE LAMP



Gris Paris - *Paris Grey*
Ref. 05552-3



Rouge Palissandre - *Rosewood Red*
Ref. 05552-2

LAMPE HERON & ARA
HERON & ARA LAMP



Lampe héron
H : 63 cm L : 48 cm l : 48 cm
6,48 kg

Heron lamp
H: 24.85" L: 18.9" W: 18.9"
14.26 lbs

Ref. 02841



Lampe Ara par Leroy Jean-François
Édition numérotée
H : 85 cm L : 40 cm l : 40 cm
6,50 kg

Macaw lamp by Leroy Jean-François
Numbered edition
H: 33.5" L: 15.7" W: 15.7"
14 lbs

Ref. 03271

Leroy

Panneau décoratif Saisons ambre bleu vert
L : 30 cm l : 30 cm E : 1 cm
2,7 kg

Amber blue green Seasons decorative panel
L: 11.8" W: 1.8" T: 0.4"
6 lbs

Ref. 05490/M



Panneau décoratif Saisons bleu rouge vert
L : 30 cm l : 30 cm E : 1 cm
2,7 kg

Blue red green Seasons decorative panel
L: 11.8" W: 1.8" T: 0.4"
6 lbs

Ref. 05490-1/M

Panneau décoratif Saisons ambre rouge
L : 30 cm l : 30 cm E : 1 cm
2,7 kg

Amber red Seasons decorative panel
L: 11.8" W: 1.8" T: 0.4"
6 lbs

Ref. 05490-2/M



PANNEAUX DÉCORATIFS

PANELS



Panneau décoratif Saisons bleu vert violet
L : 30 cm l : 30 cm E : 1 cm
2,7 kg

Blue green purple Seasons decorative panel
L: 11.8" W: 1.8" T: 0.4"
6 lbs

Ref. 05490-3/M



Panneau décoratif Saisons bleu rose vert
L : 30 cm l : 30 cm E : 1 cm
2,7 kg

Blue pink green Seasons decorative panel
L: 11.8" W: 1.8" T: 0.4"
6 lbs

Ref. 05490-4/M



FICHES TECHNIQUES
INFORMATION SHEETS

FICHES TECHNIQUES

INFORMATION SHEETS

COLLECTION IMPRÉVISIBLE IMPRÉVISIBLE COLLECTION

TABLE D'APPONT SIDE TABLE

ATELIER DAUM

Editions numérotées Numbered editions

MOBILIER FURNITURE



ref. 05577

Couleurs Aqua
Mélange aléatoire de tonalités bleues et vertes
Aqua colours
Random mix of blue and green shades

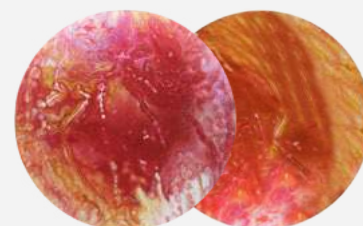

ref. 05577-1

Couleurs Solaire
Mélange aléatoire de tonalités ambres et roses
Solar colours
Random mix of amber and pink shades

MATÉRIAUX MATERIAL

PLATEAU PANEL

Pâte de cristal feuilletée avec un verre trempé
"Pâte de cristal" laminated with toughened glass

STRUCTURE STRUCTURE

Acier inoxydable poli brillant
Bright polished stainless steel

DIMENSIONS ET POIDS DIMENSIONS AND WEIGHT

D61 x H60 cm, 25,5 kg (D24" x H19,6"), 56,22 lbs

SPÉCIFICITÉS SPECIFICITIES

Plateau amovible facilitant le nettoyage et les déplacements
La partie inférieure des pieds peut se régler selon la planéité des sols
Removable panel facilitating cleaning and moving
The bottom part of the legs can be adapted to irregular floors

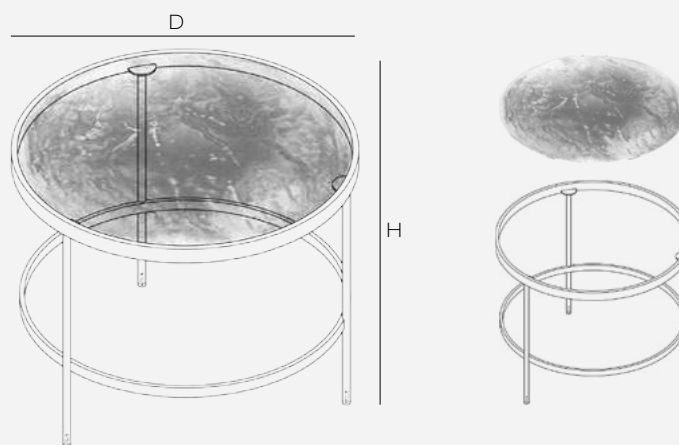

FABRICATION FRANÇAISE MADE IN FRANCE

COLLECTION VEGETALE VEGETAL COLLECTION

TABLE TABLE

ATELIER DAUM

MOBILIER FURNITURE

Ref. 05392, 05392-1, 05392-2, 05392-3

MATERIAUX MATERIAL

PLATEAU PANEL

Verre trempé extra-blanc
Extra white toughened glass

STRUCTURE STRUCTURE

Acier inoxydable poli brillant
Bright polished stainless steel

PIÈTEMENT DECOR CRISTAL BASE

Table 6 éléments : 3 panneaux supérieurs et 3 inférieurs en pâte de cristal
Table 3 éléments : 3 panneaux supérieurs en pâte de cristal
6-piece table : 3 upper pieces and 3 lower pieces in "pâte de cristal"
3-piece table : 3 upper pieces in "pâte de cristal"

DIMENSIONS ET POIDS DIMENSIONS AND WEIGHT

Plateau : Ø 160 cm - vendu séparément

Disponible en Ø 140 cm et Ø 150 cm

Panel : Ø 63" - sold separately

Available in Ø 55.1" and Ø 59"

Piètement décor : H : 75 cm - Ø supérieur : 100 cm - Ø inférieur : 64 cm, 125 kg

Crystal Base: H: 29.5" - Ø Top: 39.4" - Ø Bottom: 25.1", 275.6 lbs

SPECIFITES SPECIFITIES

Structure monobloc, assemblage du décor à la main
One-piece structure, crystal pieces assembled by hand



Ref. 05392-1



Ref. 05392-2



Ref. 05392



Ref. 05392-3

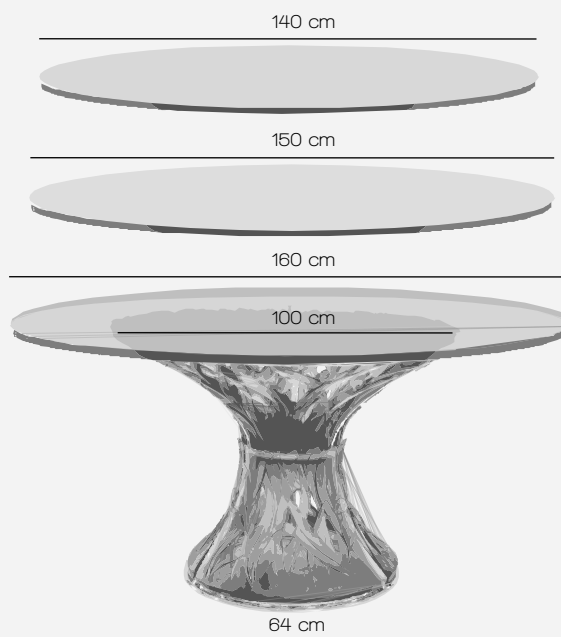

FABRICATION FRANÇAISE MADE IN FRANCE

COLLECTION VÉGÉTALE VEGETAL COLLECTION

MOBILIER FURNITURE

BOUT DE CANAPÉ SIDE TABLE

ATELIER DAUM

Éditions numérotées Numbered editions

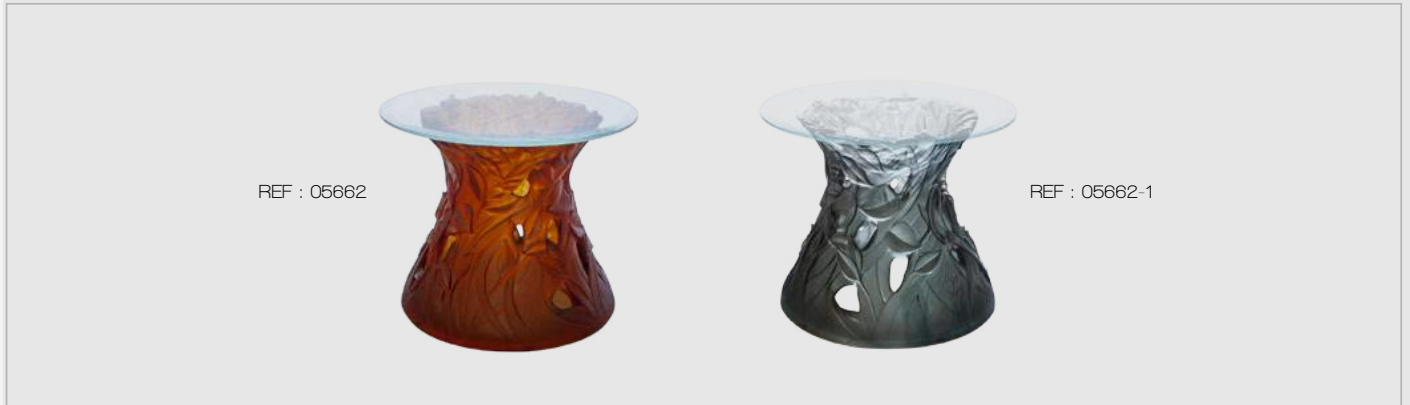

MATÉRIAUX MATERIAL

Piètement : pâte de cristal monobloc

Base: one-piece in "pâte de cristal"

Plateau : verre trempé extra-blanc

Panel: extra white toughened glass

DIMENSIONS ET POIDS DIMENSIONS AND WEIGHT

D80 x H50,5 cm, 47,5 kg D23,6" x H19,9", 104,7 lbs

épaisseur du plateau panel thickness 10 mm

SPÉCIFICITÉS SPECIFITIES

Plateau à poser centré sur le pied

The panel has to be placed at the center of the base

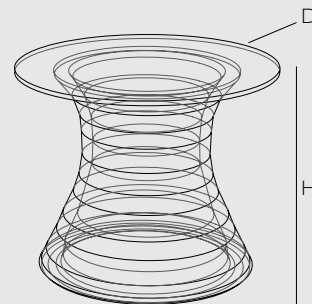

FABRICATION FRANÇAISE MADE IN FRANCE

COLLECTION VÉGÉTALE VEGETAL COLLECTION

MOBILIER FURNITURE

TABLE BASSE GRAND MODÈLE LARGE COFFEE TABLE

ATELIER DAUM

Éditions numérotées Numbered editions



MATÉRIAUX MATERIAL

Piètement : pâte de cristal monobloc

Base: one-piece in "pâte de cristal"

Plateau : verre trempé extra-blanc

Panel: extra white toughened glass

DIMENSIONS ET POIDS DIMENSIONS AND WEIGHT

L180 X L90 x H50,5 cm, 129 kg L70,9" x I35,4" x H19,9", 284,4 lbs

épaisseur du plateau panel thickness 12 mm

SPÉCIFICITÉS SPECIFITIES

Plateau à poser sur les deux pieds d'après repères figurant sur la notice

The panel has to be placed on the two bases with the measures given on the notice

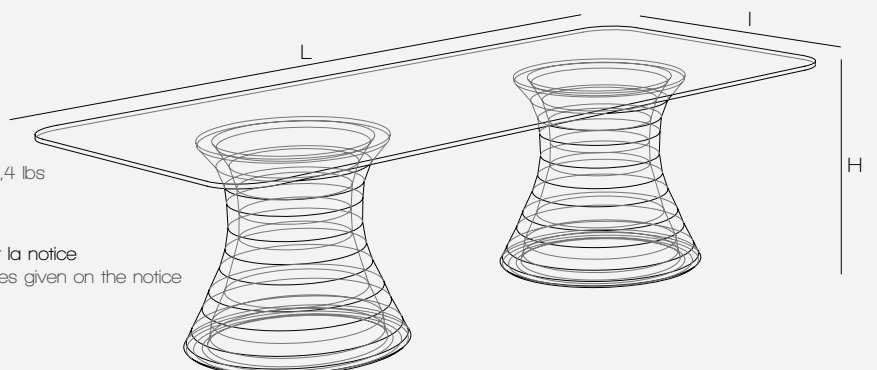

FABRICATION FRANÇAISE MADE IN FRANCE

FICHES TECHNIQUES INFORMATION SHEETS

COLLECTION VEGETALE *VEGETAL COLLECTION*
TABLE BASSE *COFFEE TABLE*
ATELIER DAUM

MOBILIER *FURNITURE*
Ref. 05406, 05406-1

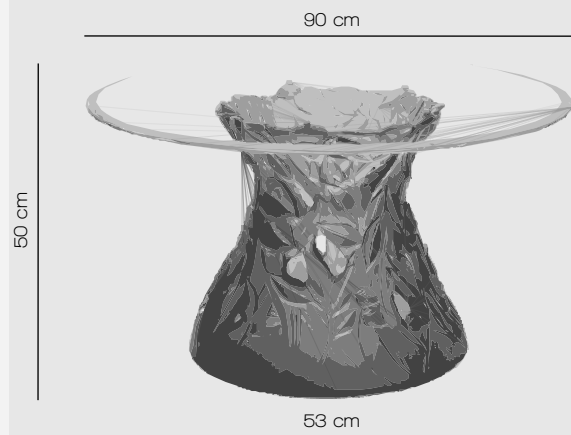

Ref. 05406

Ambre
Amber

Ref. 05406-1

Bleu-gris
Blue grey

MATERIAUX *MATERIAL*

PLATEAU *PANEL*

Verre trempé extra-blanc avec biseau
Extra white toughened bevelled glass

PIEUMENT *STAND*

Pâte de cristal monobloc
One piece in "pâte de cristal"

DIMENSIONS ET POIDS *DIMENSIONS AND WEIGHT*

Plateau : D90 cm

Panel : D35.4"

Pièment : D53 x H50 cm, 57,2 kg

Crystal Base : D21" x H19.7", 126.1 lbs

SPECIFITES *SPECIFITIES*

Assemblage du plateau par vissage en 5 points (cache-vis nickelés)
Assembled by screwing 5 screws (with nickel-plated covers)

FABRICATION FRANCAISE *MADE IN FRANCE*

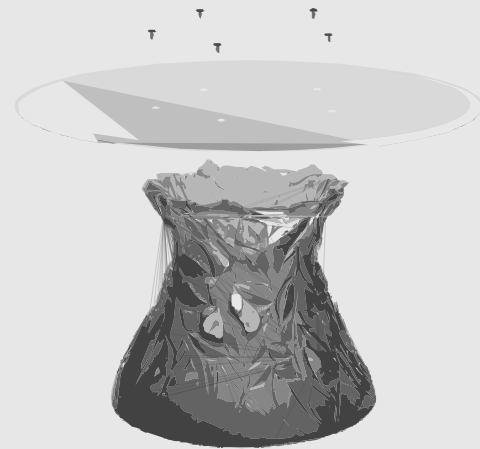

COLLECTION VEGETALE *VEGETAL COLLECTION*
APPLIQUE *WALL LAMP*
ATELIER DAUM

LUMINAIRE *LIGHTING*
Ref. 05495, 05495-1, 05495-2

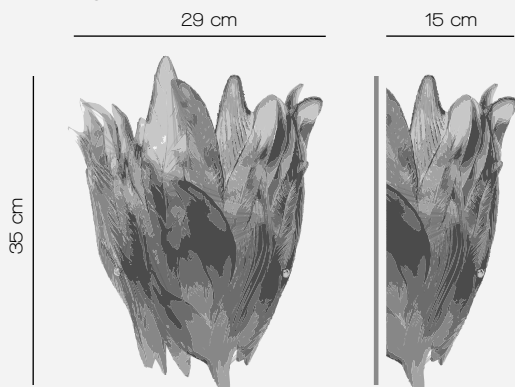

Ref. 05495



Ref. 05495-1



Ref. 05495-2

MATERIAUX *MATERIAL*

STRUCTURE *STRUCTURE*

Platine et support électrifié en nickel
Nickel wall hanger and electrified system

DECOR *CRISTAL*

Pâte de cristal monobloc
One piece in "pâte de cristal"

DIMENSIONS ET POIDS *DIMENSIONS AND WEIGHT*

Platine murale : D8 cm

Wall hanger : D2.4"

Décor : L29 x l15 x H35 cm, 3,6 kg

Crystal : L11.4" x W5.9" x H13.8", 8 lbs

SPECIFITES *SPECIFITIES*

Fixation en 3 temps (platine murale/support électrifié/cristal)
Fixing in 3 steps (wall hanger/electrified system/crystal)

Disponible en certification CE et UL : Available CE and UL certified:
zones A.C. 220-240V-50Hz, 0,75 mm² : ampoule *bulb* x1 max. 30W
zones A.C. ~ 120V-60Hz, SPT - 1 : ampoule *bulb* x1 E12 max. 40W

Possibilité de réassort séparé structure et cristal
Possible to buy the structure or the crystal part separately

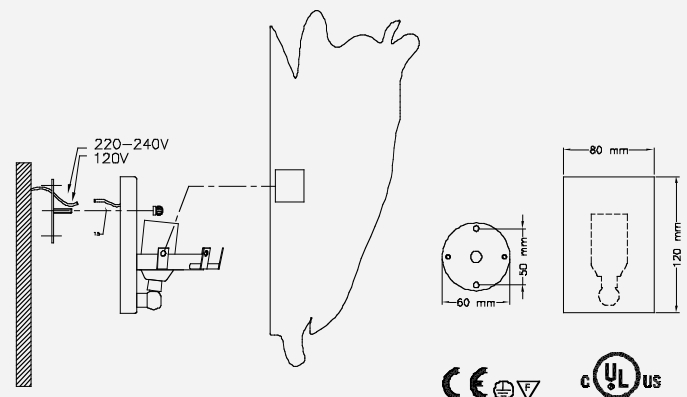

Cristal : FABRICATION FRANCAISE Support électrifié : FABRICATION ITALIENNE *Crystal: MADE IN FRANCE Electrified system: MADE IN ITALY* 

COLLECTION RÉSONANCE *RESONANCE COLLECTION*

LAMPE À POSER *TABLE LAMP*

ATELIER DAUM

Editions numérotées *Numbered editions*

LUMINAIRE D'AMBIANCE *AMBIENT LIGHTS*



MATÉRIAUX *MATERIAL*

ABAT-JOUR ET PIED *LAMP SHADE AND STAND*
Pâte de cristal mate et polie
Matt and polished "pâte de cristal"

GRIFFES ET SOCLE *CLAWS AND BASE*
Aluminium coloration champagne
Champagne-coloured aluminium

DIMENSIONS ET POIDS *DIMENSIONS AND WEIGHT*

D25 x H43 cm, 6,1 kg (D9,8" x H16,4"), 13.4 lbs

SPÉCIFICITÉS *SPECIFICITIES*

Double éclairage : E14 LED en partie supérieure et G9 LED dans le pied
Cordon d'alimentation en plastique noir
Marquage CE et certification CB
Double-lights : LED E14 on the upper part and LED G9 in the foot
Black plastic power cord
CE certified and CB certified

FABRICATION FRANÇAISE *MADE IN FRANCE*

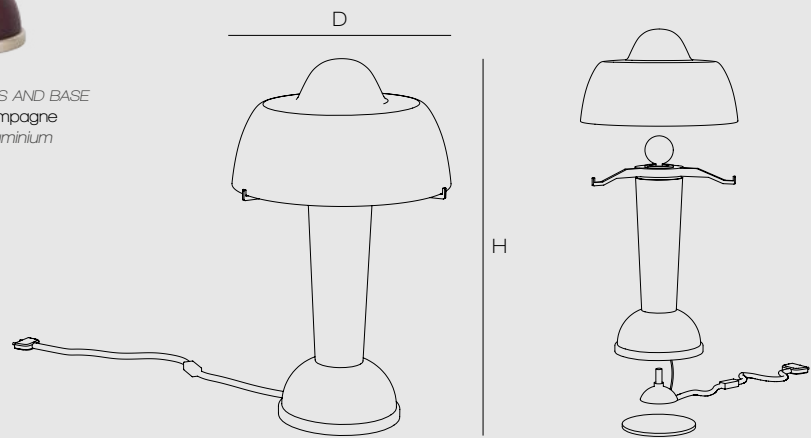

COLLECTION BORNÉO *BORNEO COLLECTION*

FEUILLES MURALES *WALL LEAVES*

EMILIO ROBBA

DÉCORATION *DECORATION*

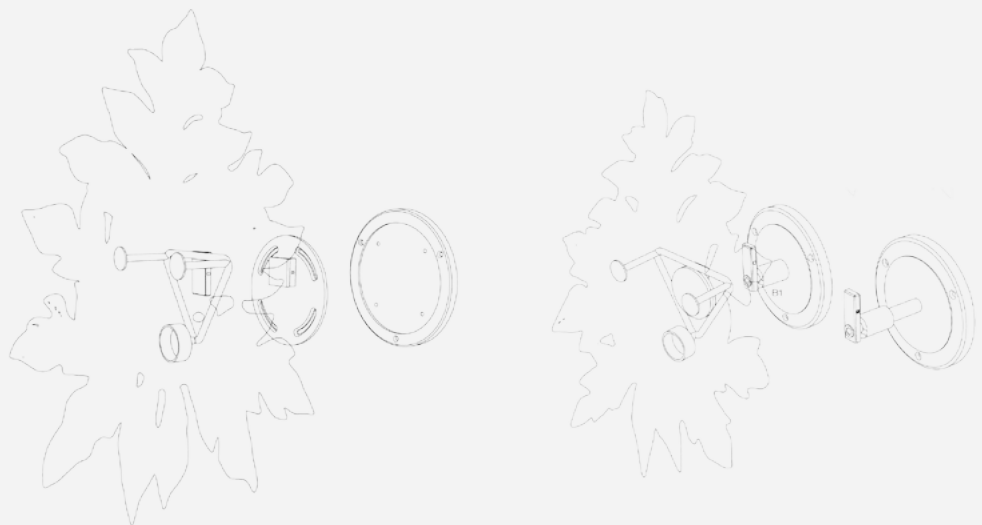

The leaf can tilt 20° from the left to the right.

The leaf can rotate on 360°.

MATÉRIAUX *MATERIAL*

Feuille : pâte de cristal monobloc *Leaf: one-piece in "pâte de cristal"*
Fixation : laiton vernis *Fixing system: varnished brass base*

DIMENSIONS ET POIDS *DIMENSIONS AND WEIGHT*

Grand modèle : L60 x I45 x P20 cm, 10 kg *Large leaf: L23.7" x W17.7" x D7.9", 22 lbs*
Petit modèle : L34,5 x I33 x P17/21 cm, 4 kg *Small leaf: L13.6" x W11.4" x D6.7/8", 8.8 lbs*

FABRICATION FRANÇAISE *MADE IN FRANCE*

FICHES TECHNIQUES

INFORMATION SHEETS

COLLECTION MONSTERA MONSTERA COLLECTION
 APPLIQUES FEUILLES MURALES WALL LAMP LEAVES
 EMILIO ROBBA

LUMINAIRES LIGHTING



The leaf can tilt 20° from the left to the right.
 Module led, classe III IP20, alimentation possible en 100 à 230V converti en 24V - Marquage CE

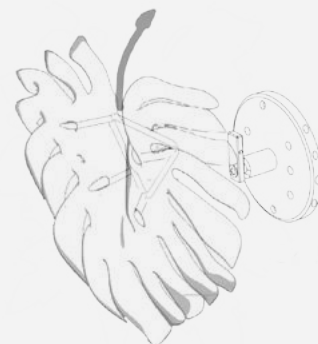

The leaf can rotate on 360°.
 Module led, classe III IP20, alimentation possible en 100 à 230V converti en 24V - Marquage CE

MATÉRIAUX MATERIAL

Feuille : pâte de cristal monobloc Leaf: one-piece in "pâte de cristal"
 Fixation grand modèle : laiton vernis et dorure mat 24 carats
 Large fixing system: varnished brass base and 24K matt gilded
 Fixation petit modèle : laiton vernis Small fixing system: varnished brass base

DIMENSIONS ET POIDS DIMENSIONS AND WEIGHT

Grand modèle : L52 x l46 x P23 cm, 10,2 kg Large leaf: L20.5" x W18.1" x D9.5", 22 lbs
 Petit modèle : L33 x l29,5 x P14 cm, 3,5 kg Small leaf: L13" x W11.6" x D5.5", 8.8 lbs

FABRICATION FRANÇAISE MADE IN FRANCE

COLLECTION MONSTERA MONSTERA COLLECTION
 FEUILLES MURALES WALL LEAVES
 EMILIO ROBBA

DÉCORATION DECORATION



The leaf can tilt 30° from the left to the right.

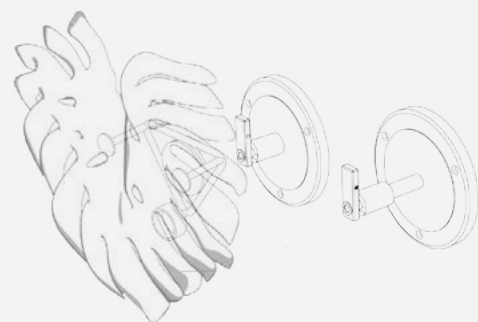

The leaf can rotate on 360°.

MATÉRIAUX MATERIAL

Feuille : pâte de cristal monobloc Leaf: one-piece in "pâte de cristal"
 Fixation : laiton vernis Fixing system: varnished brass base

DIMENSIONS ET POIDS DIMENSIONS AND WEIGHT

Grand modèle : L52 x l46 x P21 cm, 10,2 kg Large leaf: L20.5" x W18.1" x D8.3", 22 lbs
 Petit modèle : L33 x l29,5 x P14/18 cm, 3,5 kg Small leaf: L13" x W11.6" x D5.7", 8.8 lbs

FABRICATION FRANÇAISE MADE IN FRANCE

BOUTIQUES FLAGSHIP STORES

Paris
6-8 rue Royale
75008 Paris
+33 (0)1 40 06 91 08

Paris
4 rue de la Paix
75002 Paris
+33 (0)1 42 61 25 25

Nancy
14 place Stanislas
54000 Nancy
+33 (0)3 83 32 21 65

New York
499 Park Avenue
New York 10022
+1 (212) 355 2060

Singapour
Capitol Piazza
15 Stamford Road
Singapore 178906
(+65) 6100 2312

PRESSE & COMMUNICATION COMMUNICATION & PRESS

Vanessa Sitbon
+33 (0)1 42 66 36 36
vsitbon@daum.fr

SIEGE FRANCE FRANCE HEAD OFFICE

22 rue de la Trémoille
75008 Paris
+33 (0)1 42 66 36 36

FILIALES SUBSIDIARIES

Hong Kong
904-5 Tai Yip Building
141 Thomson Road
Wanchai
(+852) 3580 0222

New York
499 Park Avenue
New York 10022
+1 (212) 481 7300
marketing@daum-haviland.com

SITES OFFICIELS OFFICIAL SITES



Daum
FRANCE 1878