



LALIQUE

CATALOGUE 2019 - ARCHITECTURE D'INTÉRIEUR / *INTERIOR DESIGN*

SOMMAIRE - TABLE OF CONTENT

INTRODUCTION	4	TABLES / TABLES	81
LUMINAIRES / LIGHTINGS	11	CACTUS	81-83
APPLIQUES / WALL SCONCES	12	CHÈNE	84
2 PERRUCHES	12	COUTARD	85
AURORA CRISTALIGHT	13	TABLES BASSES / COFFEE TABLES	86
CHAMPS-ÉLYSÉES	14	PERLES D'EAU / WATER PEARLS	86
CHÈNE	15	VERSAILLES	87
GINKGO	16-18	VANITY / VANITY	88
HÉLICONIA	19	CAUSEUSES	88
KORA CRISTALIGHT	20	ASSISES / SEATINGS	89
ORGUE	21	CHAISE CONTEMPORAINE	90
PALME	22	CONTEMPORARY CHAIR	90
SERENE	23-27	COUTARD	90-91
SÉVILLE	28	AUTRE MOBILIER	93
LAMPES / LAMPS	29	OTHER FURNITURE	93
COUTARD	29	MIROIRS / MIRRORS	94
FAUNES	30	LANGUEDOC	94-95
GINKGO	31	LES CAUSEUSES	96
HIRONDELLES	32	MERLES ET RAISINS	97
JOSÉPHINE	33	OcéANIA	98
MASQUE DE FEMME	34	RINCEAUX	99
MOSSI	35	POIGNÉES DE PORTE ET BOUTONS	100
POSÉIDON	36	DOOR HANDLES AND KNOBS	100
SERENE	37	FAUNES	100-101
VERSAILLES	38	BUCOLIQUE	102
LANTERNES / LANTERNS	39	MASQUE DE FEMME	103
COUTARD	39-40	MÉTROPOLIS	104
GINKGO	41	PERLES	105
LUSTRES / CHANDELIERS	42	PANNEAUX DÉCORATIFS	106
CHAMPS-ÉLYSÉES	42-46	DECORATIVE PANELS	106
CHÈNE	47	COUTARD	115
GINKGO	48	FEMME BRAS LEVÉS	116-117
HIRONDELLES	49-50	FEMME TÊTE LEVÉE	118
ORGUE	51-53	FIGURINE ET RAISINS	119
SERENE	54-61	JOUEUR DE PIPEAU	120
SÉVILLE	63	LAURIERS	121
PLAFONNIER / CEILING LIGHT	62	LES CAUSEUSES	122
CORALLINE	62	MASQUE DE FEMME	123
SUSPENSIONS / CEILING LAMPS	64	MERLES ET RAISINS	124-126
COUTARD	65	PÉTITES BULLES	127
GINKGO	65-66	RAISINS	128-129
SERENE	67-69	ROSES	130
VIBRATION	70	SOUDAN	131
TABLES & MEUBLES DE RANGEMENT	71	VIBRATION	132
TABLES & CABINETS	71	PANNEAUX D'ESPACE	135
BUREAU / DESK	72	INTERIOR PANELS	135
COUTARD	72	BOUQUET	142
COMMODE / DRAWER UNIT	73	DAHLIA	143
VIBRATION	73	LANGUEDOC	144-145
CONSOLES / CONSOLES	74	VENISE	146
CACTUS	74-75	ÉCHANTILLONS / SAMPLES	147
SÉVILLE	76	BOUQUET	147
GUÉRIDONS / PEDESTAL TABLES	77	DAHLIA	147
MARSAN	77	LANGUEDOC	148
ROSES	78	VENISE	148
SOUDAN	79		
VERSAILLES	80		

SOMMAIRE - TABLE OF CONTENT

LALIQUE MAISON 149

LUMINAIRES / LIGHTINGS 153

LAMPES / LAMPS 154

FEMME BRAS LEVÉS	154
JOUEUR DE PIPEAU	155
MERLES ET RAISINS	156
RAISINS	157-160

TABLES & MEUBLES DE RANGEMENT / TABLES & CABINETS 161

ARMOIRES / CABINETS 162

FEMME BRAS LEVÉS	162
MERLES & RAISINS	163

BARS / BARS 164

DRAGON	164
FEMME BRAS LEVÉS	165
JOUEUR DE PIPEAU	166
LONGCHAMP	167
MASQUE DE FEMME	168
MERLES ET RAISINS	169
RAISINS	170-171

BIBLIOTHÈQUES / LIBRARIES 172

RAISINS	172-173
---------	---------

BUREAUX / DESKS 174

RAISINS	174
---------	-----

CABINET / CABINET 175

RAISINS	175
---------	-----

COIFFEUSES / DRESSING TABLES 176

MASQUE DE FEMME	176
RAISINS	177-178

COMMODES / DRAWER UNIT 179

RAISINS	179
---------	-----

COMMODES / TALL BOY 180

MASQUE DE FEMME	180
RAISINS	181

CONSOLES / CONSOLES 180

LONGCHAMP	182
MASQUE DE FEMME	183-184
RAISINS	185-186
ROSES	187

CRÉDENCES / SIDEBARDS 188

DRAGON	188
MASQUE DE FEMME	189
RAISINS	190-191

TABLES / TABLES 192

RAISINS	192-193
---------	---------

TABLES D'APPOINT / SIDE TABLES 194

MASQUE DE FEMME	194
RAISINS	195-196

TABLES BASSES / COFFEE TABLES 197

MASQUE DE FEMME	197
RAISINS	198-200

TABLES DE CHEVET / BEDSIDE TABLES 201

MASQUE DE FEMME	201
RAISINS	202-203

TABLES GIGOGNES / SIDE TABLES (NESTING TABLES) 204

MASQUE DE FEMME	204
RAISINS	205

VITRINE / DISPLAY UNIT 206

DAHLIA	206
--------	-----

ASSISES / SEATINGS 207

CANAPÉS CLASSIQUES / CLASSIC SOFAS 208

RAISINS	208-209
---------	---------

CANAPÉS CONTEMPORAINS / CONTEMPORARY SOFAS 210

MASQUE DE FEMME	210-213
RAISINS	214

CHAISES CONTEMPORAINES / CONTEMPORARY CHAIRS 215

MASQUE DE FEMME	215-216
RAISINS	217

CHAISES CLASSIQUES / CLASSIC CHAIRS 218

MASQUE DE FEMME	218-219
-----------------	---------

FAUTEUILS CONTEMPORAINS VILLA RENÉ LALIQUE / VILLA RENÉ LALIQUE CONTEMPORARY ARMCHAIRS 220

MASQUE DE FEMME	220
RAISINS	221

CHAISES DE BAR / BARSTOOL 222

MASQUE DE FEMME	222
-----------------	-----

FAUTEUILS CLUB CLASSIQUES / CLASSIC CLUB ARMCHAIRS 223

RAISINS	223
---------	-----

FAUTEUILS CLUB CONTEMPORAINS / CONTEMPORARY CLUB ARMCHAIRS 224

MASQUE DE FEMME	224
-----------------	-----

FAUTEUILS / ARMCHAIRS 225

LONGCHAMP	225
PANTHÈRE	226
VICTOIRE	227

OTTOMANS / OTTOMANS 228

MASQUE DE FEMME	228-229
RAISINS	230-231

SOMMAIRE - TABLE OF CONTENT

AUTRE MOBILIER **OTHER FURNITURE** **233**

LITS / BEDS **234**

MASQUE DE FEMME	234
RAISINS	235

CADRES TV / TV FRAMES SURROUND **236**

RAISINS	236
---------	-----

MIROIRS / MIRRORS **237**

MASQUE DE FEMME	237
RAISINS	238-240
ROSES	241
TIANLONG	242

LINGE DE MAISON **SOFT FURNISHING** **243**

COUSSINS / CUSHIONS **244**

2 POISSONS / KOI CIRCLE	244
CHEVAL BONDISSANT/ LEAPING HORSE	245
CHEVAL DEBOUT/ STANDING HORSE	246
COUTARD	247
DEMI COUTARD	248
DRAGON	249
HIRONDELLES	250
MASQUE DE FEMME	251-252
PANTHÈRE/ PANTHER	253

LINGE DE LIT / BED LINEN **254**

COUVRE-LITS PERLÉS / BEADED BED-COVERS **254**

RAISINS	254
---------	-----

DRAPS BRODÉS **EMBROIDERED TOP FLAT SHEETS** **255**

RAISINS	255
---------	-----

DRAPS HOUSSE **PLAIN FLAT BOTTOM SHEETS** **255**

RAISINS	255
---------	-----

HOUSSES DE COUETTE BRODÉES **EMBROIDERED DUVET COVERS** **256**

RAISINS	256
---------	-----

PLAID EN CACHEMIRE PERLÉ **BEADED CASHMERE THROW** **257**

HIRONDELLES	257
-------------	-----

TAIES D'OREILLER BRODÉES **EMBROIDERED PILLOW CASES** **258**

OXFORD	258
RAISINS	259

LINGE DE TOILETTE / BATH LINEN **260**

CARRÉS BRODÉS / **EMBROIDERED SQUARE TOWELS (FACE CLOTH)** **260**

LALIQUE	260
---------	-----

LINGE DE TOILETTE / BATH LINEN **261**

RAISINS	261
---------	-----

PEIGNOIR BRODÉ **EMBROIDERED BATHROBE** **262**

HIRONDELLES	262
-------------	-----

TAPIS DE BAIN BRODÉS **EMBROIDERED BATH MATS** **263**

HIRONDELLES	263
-------------	-----

LINGE DE TABLE / TABLE LINEN **264**

SERVIETTES ET SETS DE TABLE **NAPKINS AND PLACEMATS** **264**

1 HIRONDELLE	264
4 HIRONDELLES	265
2 POISSONS / KOI CIRCLE	266
RINCEAUX / SCALLOP	267



LALIQUE... LA MAGIE D'UN NOM, LE GÉNIE D'UN CRÉATEUR

Un passé, une histoire qui se confondent avec l'histoire des Arts décoratifs et du XX^e siècle.

Attentif aux êtres et à la nature, doué de dons exceptionnels, René Lalique commence sa carrière de créateur dans la joaillerie. Bijoutier-poète le plus célèbre de la Belle époque, il devient le maître absolu du bijou Art Nouveau où il mêle symbolisme et naturalisme. S'inspirant des artistes japonais, remettant au goût du jour des techniques et des matières telles la corne, l'émail, l'ivoire ou le verre, depuis longtemps délaissées, il est l'inventeur du bijou moderne. Dès le début du XX^e siècle, il connaît la gloire, fournit les cours d'Europe, les musées et les collectionneurs.

En 1907, René Lalique se passionne pour le verre qu'il avait introduit dans ses bijoux. L'artisan - créateur se transforme en industriel, réinventant le flacon de parfum, mettant au point le verre opalescent. Artiste génial, il décore l'Orient Express, le paquebot Normandie, crée les fontaines du rond-point des Champs Elysées, de nombreux objets, du plus usuel au plus audacieux, contrôlant et affinant transparence et reflets, avec là encore un succès international jusqu'à sa mort en 1945.

Il reste le maître incontesté d'un style et d'une matière... le verre.

Ses successeurs ont imposé définitivement le cristal en restant fidèles à l'esprit de René Lalique. Aujourd'hui, un atelier de création perpétue son savoir-faire et son style.

LALIQUE... THE MAGIC OF A NAME THE GENIUS OF A CREATOR

A past, a history tied-in with the history of decorative arts and the 20th century.

Attentive to living beings and nature, and endowed with exceptional gifts, René Lalique started his career in jewellery. This artist jeweller and poet was the most famous name of the Belle époque. He became the absolute master of the Art nouveau jewel, in which he blended symbolism and naturalism, inspired by Japanese artists, and remodelled long-abandoned techniques and materials such as horn, enamel, ivory and glass to please contemporary tastes. Lalique was the inventor of modern jewellery. From the beginning of the 20th century, he became famous, a purveyor to the courts of Europe, museums and collectors.

In 1907, René Lalique acquired a passion for glass, which had become an element of his works. The artist craftsman became a manufacturer, reinventing the perfume bottle and developing opalescent glass. He decorated the Orient Express and the Normandy cruise ship, designed the fountains on the Rond Point des Champs Elysées, and produced a host of objects - from the more mundane to the most daring - controlling and refining transparency and reflection, with an international success that continued to his death in 1945.

He remains the undisputed master of a style and of a material : glass.

His successors have definitively imposed crystal, while remaining faithful to the spirit of René Lalique. Today, a crystal design shop carries on his skill and knowledge and his style.

INTRODUCTION

UN SAVOIR-FAIRE EXCEPTIONNEL AU SERVICE DE LA CRÉATION ET DE L'ÉMOTION

Depuis 1921, la Manufacture installée en Alsace, région de tradition verrière, perpétue un savoir-faire artisanal. La main de l'homme, artiste - artisan de la matière, marque les objets de son empreinte et leur confère cette force, cette présence très «immatérielle» : notre savoir-faire.

Le style Lalique naît sous le geste de l'artiste esquissant un dessin en osmose totale avec la matière, un style reconnaissable au modelage manuel des pièces et des décors, comme une sculpture, à la richesse du décor figuratif, aux finitions qui donnent ce contraste caractéristique de cristal clair et satiné. Une culture de la douceur, de la féminité, de la nature nourrie d'une forte inspiration Art Nouveau et Art Déco.

Sculpteur de lumière...

Quand ce qui est contenu dans la matière naît à la lumière...

Lalique, la seule marque de cristal qui, dans un geste artistique, métamorphose la matière brute, fusion à 1 400° de silice et de plomb, en des objets uniques qui méritent le statut d'œuvres d'art.

LA MANUFACTURE

Tous les produits Lalique sont, pour le monde entier, fabriqués à la manufacture de Wingen sur Moder. On y cultive la tradition de ce savoir-faire qui transmis depuis des générations, forge l'identité et la mémoire de chaque pièce. Notre Manufacture est fière de compter parmi ses artistes 7 Meilleurs Ouvriers de France. Cette distinction s'acquiert à l'issue d'un concours national ayant lieu tous les 3 ans où ils sont jugés par leurs pairs sur un travail de recherche et un ouvrage d'art, faisant preuve de leur talent. Ils doivent y faire apparaître leur dextérité, leurs connaissances techniques évolutives, leur créativité et



LALIQUE: EXCEPTIONAL KNOW HOW SERVING CREATIVITY AND EMOTION

Since 1921, the Manufacture located in Alsace, area renowned for its glassmaking, has perpetuated an traditional know-how.

The human hand, that of both artist and craftsman, marks every object of its print and its strength, which convey this "immaterial" presence: our know-how.

The Lalique style comes from an artistic gesture, outlining a drawing in total osmosis with crystal, a style that one easily recognises through the manual modelling of the shapes and patterns, as if sculptured, the richness of the figurative details, the different types of finishing which create this characteristic contrast of clear and matt crystal. An identity built by softness, femininity, nature with strong Art nouveau and Art Deco inspirations.

Light sculptor...

When what is contained in the matter is revealed through the light...

Lalique, the only crystal Brand which, through an artistic gesture and the fusion at 1 400° C of lead and sand, metamorphoses raw material into unique artworks.

THE MANUFACTURE

All Lalique items are, for the whole world, manufactured in Wingen on Moder-France. One cultivates there the tradition of this priceless know-how. Transmitted since generations, it has forged the identity and the memory of each creation. Our Manufacture is proud to count among its artists 7 "Meilleurs Ouvriers de France". This distinction is acquired at the end of a national contest taking place every 3 years, where they are evaluated by their peers on a research task and an artwork, showing their talent. These must express their dexterity, their evolutive technical skills, their creativity, their mastery of both modern techniques and

INTRODUCTION

tout autant l'usage de techniques modernes que le respect des méthodes traditionnelles. En toute humilité, nos Maîtres verriers sont fiers de leur savoir-faire. Ils fabriquent eux-mêmes certains de leurs outils et reprennent des gestes anciens, transmis de génération en génération, les mêmes instruments pour venir cueillir, du bout de leur canne, le cristal en fusion. C'est alors, une étrange chorégraphie faite de souffles, de tournoiements et de gestes mesurés. Il s'agit d'arrondir la matière, de calmer le cristal, de lui donner forme, de lui donner vie.

L'alchimie du cristal

La magie du cristal s'opère dans la fusion, étape par laquelle le sable, la potasse, le minium de plomb et le groisil se métamorphosent, suivant des dosages qui restent un secret jalousement conservé, en une matière brillante, lumineuse et à la sonorité si particulière qui le distingue du verre.

La couleur

La recherche sur les couleurs est une caractéristique du style Lalique. À la composition de base sont ajoutés différents oxydes de métaux ou terres rares, chacun donnant une teinte au cristal. Ces mélanges, mis au point avec minutie, permettent de disposer aujourd'hui d'une palette riche de plus de 100 couleurs et nuances.

Certaines teintes sont plus difficiles à travailler comme le noir, le rouge, l'ambre, l'antinéa ou l'opale. Par exemple, pour conserver sa transparence au cristal opalescent, nous n'utilisons la composition d'un creuset qu'une seule journée. Chaque jour, les Maîtres Verriers vident les pots de la matière et la remplacent par une nouvelle composition. Les pièces réalisées en rouge à l'or requièrent également un haut degré de maîtrise technique et de la patience car elles sortent incolores du travail au verre chaud, la couleur ne se révélant qu'après la recuisson qui, par exemple, dure 6 jours sur le vase *Serpent*. Un cycle de couleur doit être respecté pour une utilisation optimale du pot : des couleurs claires aux couleurs foncées. Ainsi, après une composition de cristal noir, le pot devient inutilisable.

Poterie & moulerie

Lalique est une des seules manufactures à fabriquer encore ses pots ou creusets, fabriqués à la main dans une argile pure, et dans lesquels sera fondu le cristal. De la qualité de cette argile dépend la qualité des pots et donc celle du cristal. La fabrication des pots dure environ 9 mois à l'issue desquels il sera enfin possible de déterminer si le pot est apte à être enfourné. La Manufacture réalise également ses propres moules en fonte, dont une intérieuriste sculpte chaque détail pour rendre l'œuvre conforme à l'esprit de son créateur.

traditional methods. With much humbleness, our glass Masters are proud of their know-how. They make some the tools they works with and take up old gestures, transmitted from generation to generation, the same instruments to gather the molten crystal. This amazing choreography is made of blowing, whirling and measured gestures. It is a question of taming the matter, calming the molten crystal, to define a shape and give life to the item.

The alchemy of crystal

The Magic of crystal takes place in the fusion. At this stage, the sand, potash, lead oxide and recycled crystal (cullet) mixed in proportions which remain a jealously kept secret, metamorphose into brilliant and luminous crystal, with this particular sonority that distinguishes it from mere glass.

The colour

Research on the colours is characteristic of Lalique. style. Various metal oxides or rare types of earth are added to the basic composition, each one giving a specific colour to the crystal. These meticulously developed mixtures allow us to obtain a pallet rich of more than 100 colours and shades. Some colours are more difficult to work on such black, red, amber, antinéa or opalescent. For example, to preserve the transparency of opalescent crystal, we chose to use the composition molten in a pot only one day. Every day, Glass Masters empty the pots of the matter and replace it by a new composition. The pieces carried out in red with gold also require a high degree of technical mastery and a lot of patience since they remain clear at the end of the hot glass stage, the colour appearing only after the re heating which, for example, lasts 6 days on the "Serpent" vase. A colour cycles must be respected for optimal use of the pots: from light colours to darker ones. Thus, once a pot has served to melt black crystal, it becomes unusable.

Pottery, moulding

Lalique is one of last crystal Brand to still handcraft its pots (or crucibles), made with pure clay and in which the crystal is molten. The quality of this clay determines that of the pots and thus, that of crystal. Making a pot takes approximately 9 months. Only then can one tell whether the pot can be charged in the furnace. Our manufacturer also handcrafts its own cast iron moulds. A sculptor ("intérieuriste") sculpts each detail of these moulds to respect the intentions of the Creation Studio.



Remarquez le courage de ces hommes qui, dans leurs tenues de protection, bravent des températures extrêmes dans un ballet spectaculairement orchestré, pour placer les pots dans le four à plus de 1 800°C. Une fois le pot installé, la montée en température du cristal dure deux jours.

One should notice the courage of these men who, in their protective outfits, face extremely high temperatures in a spectacularly orchestrated ballet, to place the pots in the furnace at more than 1 800°C. Once the pot installed, the rise in temperature of the crystal takes two days.

LE TRAVAIL AU VERRE CHAUD

HOT WORK PROCESS

Le Cueillage

La fabrication s'articule autour de 2 étapes essentielles : «le verre chaud» et le «verre froid». L'étape du Verre Chaud comprend les opérations de cueillage, de nettoyage puis de mise en forme et de recuisson.

Le cristal en fusion est «cueilli» au centre du creuset par le Maître Verrier au moyen d'une canne. Les boules de feu se croisent alors furtivement dans une cadence parfaitement orchestrée par le chef de place. Pour les grandes pièces, le cueillage est réalisé en plusieurs fois et peut atteindre 30 kg de matière en fusion. Les bulles et imperfections sont ôtées de cette boule de feu aux ciseaux.

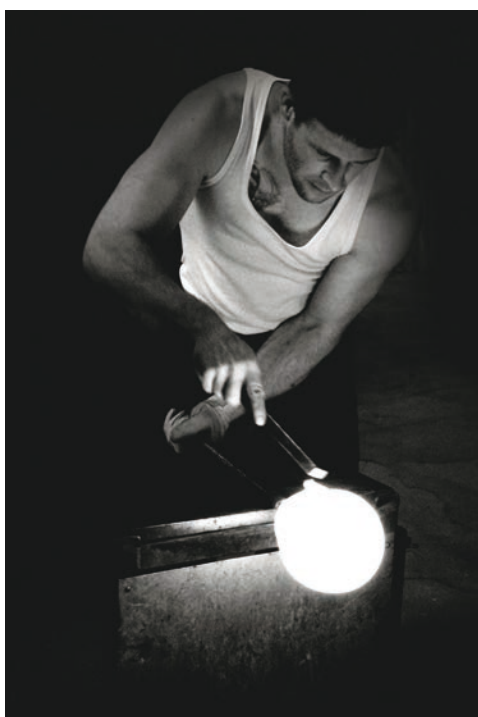

Gathering crystal

The manufacturing process comprises 2 essential stages: the "hot glass" and "cold glass" processes. The stage of Hot Glass process includes the operations of gathering, cleaning, shaping and re heating.

Each piece is born from fusing crystal, the fruit of a battle with time and temperature. The molten crystal is gathered at the centre of the crucible by the Glass Master with a cane. The fireballs then cross furtively in a rate perfectly orchestrated by the chief of place. For large items, the gathering is carried out in several times and can reach up to 30 kg of molten crystal. Cleaning consists in removing every bubbles and imperfections are removed from these fireballs with scissors.

INTRODUCTION

La mise en forme et la recuisson

La pièce est mise en forme selon différentes techniques qui vont du soufflé fixe au soufflé tourné en passant par le pressé sur une presse à balancier manuel. L'objet est ensuite transporté à l'aide du pontil jusqu'à l'arche de recuisson, dans laquelle il est déposé sur un tapis roulant, où suivant des paliers de températures décroissants, il se refroidit peu à peu. Cette étape permet de stabiliser les tensions internes du cristal. Sans elle, la pièce éclaterait au moindre choc.

LE TRAVAIL AU VERRE FROID

Taille & retouche

L'ébauche ainsi obtenue va subir, dans les ateliers de travail à froid, une suite d'opérations manuelles qui représentent les 3/4 du temps consacré à la fabrication de chaque objet. Ainsi, une pièce passe en moyenne entre les mains de 20 personnes, dont un minimum de 12 personnes au verre froid. Cette importance donnée au verre froid, qui fait la particularité de Lalique, s'explique par l'extrême attention portée au détail, aux finitions et à la sculpture des pièces. Cette étape du Verre Froid comprend les opérations de taille et retouches et les finitions. La taille et la retouche permettent de reprendre la surface afin d'éliminer les imperfections laissées par le travail à chaud (coutures de moule, plis...).

Sculpture et finitions

Commence alors un véritable travail de sculpture : les arrêtes sont avivées, certains détails sont soulignés par gravure pour redonner de la nervosité à la pièce et la rendre conforme à l'intention de la création. Ainsi, le mouvement d'une chevelure, la colonne vertébrale d'un nu ou le détail de l'expression d'un visage seront resculptés.

Viennent ensuite les finitions. Il en existe plusieurs, pouvant être combinées sur une même pièce et toujours entièrement réalisées à la main. Le polissage, le satinage, le sablage, le matage, l'émaillage au pinceau sont nos finitions privilégiées, mises au service de la création qui recherche toujours à trouver l'osmose entre le décor, les finitions et la matière.

Shaping and re heating

The item is shaped according to various techniques which range from "soufflé fixe" (fixed while blown) to "soufflé tourné" (turned while blown) or "pressé" then carried with the help of a tool called "pontil" to the re heating arch. It is set down on a conveyor belt, and goes through decreasing temperatures to cool off gently. This stabilises the internal tensions of crystal. Otherwise, the piece would burst at the smallest shock.

THE COLD WORK PROCESS

Cutting and touching up

The outline thus obtained will undergo a succession of manual operations in the workshops of cold work. These represent 3/4 of the time spent to the manufacture of each object. Thus, each piece is manipulated by the hands of 20 persons, with a minimum of 12 persons at the cold work process. This importance given to cold glass, is characteristic of Lalique. It is the result of the extreme attention given to details, finishing and to the sculpture of each creation. This stage of Cold Glass includes the operations of cutting, touching up and the finishing. The cutting, touching up consist in improving the surface in order to eliminate any imperfections left at the hot work stage. (seams of the moulds...).

Sculpting and finishing

Each object is sculpted to highlight each detail and give both life and movement, following the intention of the Creation Studio. Thus, the hair or vertebral column of a nude, the details of a face are re sculpted. The items then undergo the finishing process. There are several types of finishing, which can be combined together. Polishing, satin-finish, sanding, matt-finish, enamelling by hand are our favourite. The technique used depends on the required aspect of the item. The creation studio considers all the parameters to find the perfect osmosis between the decor, the finishing and the material.

INTRODUCTION

LE CHOIX

Chez Lalique, on parle volontairement de choix plutôt que de contrôle qualité : les pièces sont en effet choisies non seulement en fonction de critères techniques (absence de défauts) mais aussi suivant des critères esthétiques, dans le respect de l'esprit de la création.

Chaque pièce doit passer avec succès plusieurs étapes de choix intermédiaires avant d'être revêtue de la signature Lalique réalisée à main levée, au moyen d'une pointe diamantée, preuve de son authenticité et de sa qualité.

THE CHOICE

At Lalique, one voluntarily speaks about "choice" rather than of "quality control": the objects are selected not only according to technical criteria (absence of defects) but also according to aesthetic criteria, with full respect of the creation's intentions. Each item must pass successfully several intermediary choices before they can be signed by hand, sign of its authenticity and quality.





Ampoule fluorescente, halogène
et LED E12 - E14 - E26 - E27 - G9 - G4 /
*Fluorescent, halogène and LED
bulb E12 - E14 - E26 - E27 - G9 - G4*

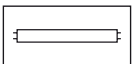

Tube fluorescent / *Fluorescent tube*

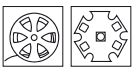

Disques, bandes de LEDs /
LED disks, strips

EU

Branchement Europe /
Europe plug

US

Branchement USA /
USA plug

UK

Branchement Royaume-Uni /
United Kingdom plug

CE

Certifié norme CE (230V Europe) /
Certified CE standard (230V Europe)

UL

Certifié norme UL (120V US) /
Certified UL standard (120V US)

IP20

IP30

Ce produit est conçu pour une utilisation intérieur. Il n'est pas destiné à être installé dans une salle de bain ou dans des locaux humides. Le luminaire ne doit pas entrer en contact avec l'eau. /

This product is designed for internal use. It is not intended to be installed in a bathroom or other damp premises. The light-fitting must not be in contact with water.



La finition « chromée » correspond dans le catalogue à un rendu argenté.
The "chrome" finishing in the catalogue corresponds to a silver rendering.

LUMINAIRES - *LIGHTINGS*



APPLIQUES - WALL SCONCES

2 PERRUCHES



183 mm / 7.20"
110 mm / 4.33"
86 mm / 3.39"
411 mm / 16.18"
161 mm / 6.34"

4,5 kg / 9.92 pounds
Abat-jour Ø 130 mm
Lampe shade Ø 5.12"

Incolore / Clear
Chromé / Chrome



Incolore / Clear
Doré / Gilded

FINITION / FINISHING



CRISTAL INCOLORE - CLEAR CRYSTAL
CHROMÉ - CHROME

REFERENCE

EUROPE
10611200

EAN CODE



CRISTAL INCOLORE - CLEAR CRYSTAL
CHROMÉ - CHROME

US
10611300



CRISTAL INCOLORE - CLEAR CRYSTAL
DORÉ - GILDED

EUROPE
10631300



CRISTAL INCOLORE - CLEAR CRYSTAL
DORÉ - GILDED

US
10631400



LED x 2 - 9 watts (socle - base) + G9 x 1 - 23 watts (abat-jour - lampshade) - 500 lumens

CE IP20 4100°K - Lumière neutre - Neutral light

2017 - PIERRE-YVES ROCHON POUR LALIQUE

Détails techniques et instructions de montage : cf fiche architecture. / Technical datas & mounting instructions: see architecture files.

AURORA CRISTALIGHT



FINITION / FINISHING



CRISTAL INCOLORE - CLEAR CRYSTAL
CHROMÉ - CHROME



CRISTAL INCOLORE - CLEAR CRYSTAL
CHROMÉ - CHROME

REFERENCE

EUROPE
10084600

US
10084700

EAN CODE



LED x 3 - 3 watts - 280 lumens

CE IP20 4100°K - Lumière neutre - Neutral light

2010 - LALIQUE

Détails techniques et instructions de montage : cf fiche architecture. / Technical datas & mounting instructions: see architecture files.

APPLIQUES - WALL SCONCES

CHAMPS-ÉLYSÉES

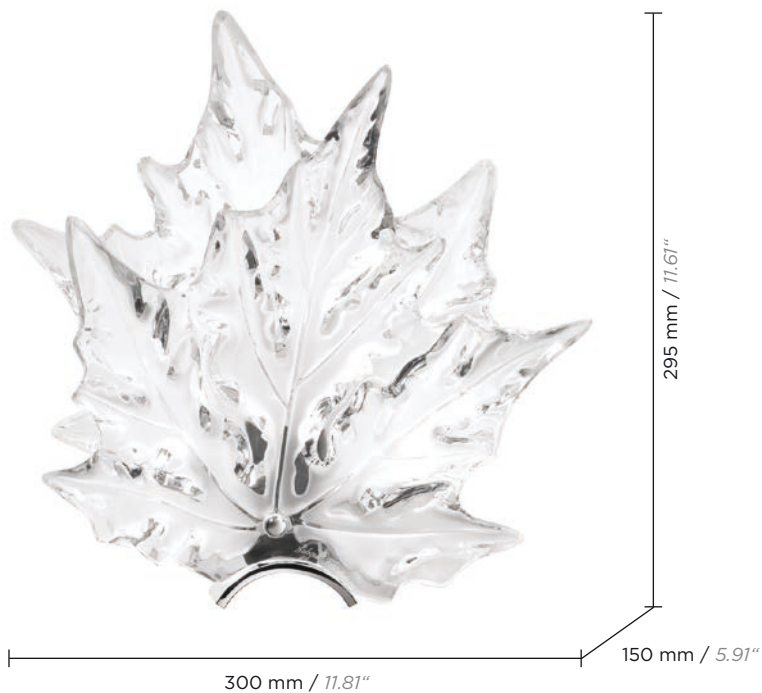

5 kg / 11.02 pounds

Incolore / Clear
Chromé / Chrome



Incolore / Clear
Doré / Gilded



Lustré or / Gold luster
Doré / Gilded

FINITION / FINISHING

REFERENCE

EAN CODE

	CRISTAL INCOLORE - CLEAR CRYSTAL CHROMÉ - CHROME	EUROPE 1001000	
	CRISTAL INCOLORE - CLEAR CRYSTAL CHROMÉ - CHROME	US 1001099	
	CRISTAL INCOLORE - CLEAR CRYSTAL DORÉ - GILDED	EUROPE 1001100	
	CRISTAL INCOLORE - CLEAR CRYSTAL DORÉ - GILDED	US 1001199	
	CRISTAL LUSTRÉ OR - GOLD LUSTER CRYSTAL DORÉ - GILDED	EUROPE 10584700	
	CRISTAL LUSTRÉ OR - GOLD LUSTER CRYSTAL DORÉ - GILDED	US 10584800	



E14 x 1

CE IP20

2700°K - Lumière chaude - Warm light

1957 - Marc Lalique

Détails techniques et instructions de montage : cf fiche architecture. / Technical datas & mounting instructions: see architecture files.



Incolore / Clear
Doré / Gilded

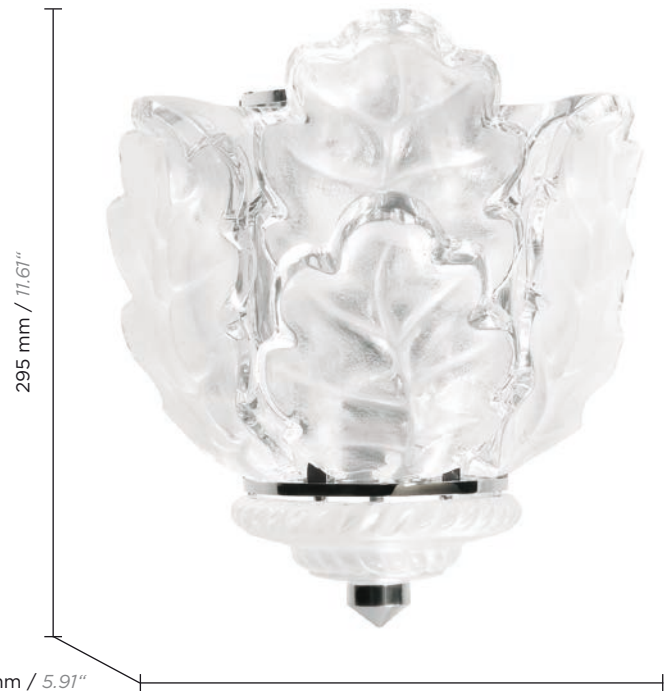

295 mm / 11.61"
150 mm / 5.91"
245 mm / 9.65"

7,4 kg / 16.31 pounds

Incolore / Clear
Chromé / Chrome

FINITION / FINISHING

REFERENCE

EAN CODE



CRISTAL INCOLORE - CLEAR CRYSTAL
CHROMÉ - CHROME

EUROPE
1000900



CRISTAL INCOLORE - CLEAR CRYSTAL
CHROMÉ - CHROME

US
1000999



CRISTAL INCOLORE - CLEAR CRYSTAL
DORÉ - GILDED

EUROPE
1001900



CRISTAL INCOLORE - CLEAR CRYSTAL
DORÉ - GILDED

US
1001999



E14 x 1

CE IP20

2700°K - Lumière chaude - Warm light

1955 - Marc Lalique

Détails techniques et instructions de montage : cf fiche architecture. / Technical datas & mounting instructions: see architecture files.

APPLIQUES - WALL SCONCES

GINKGO PM / SS



4 kg / 8.82 pounds

Incolore / Clear
Chromé / Chrome



Incolore / Clear
Doré / Gilded

FINITION / FINISHING



CRISTAL INCOLORE - CLEAR CRYSTAL
NICKEL - NICKEL

REFERENCE

EUROPE
10577900

EAN CODE



CRISTAL INCOLORE - CLEAR CRYSTAL
NICKEL - NICKEL

US
10578000



CRISTAL INCOLORE - CLEAR CRYSTAL
DORÉ - GILDED

EUROPE
10578100



CRISTAL INCOLORE - CLEAR CRYSTAL
DORÉ - GILDED

US
10578200



E14 x 1

CE IP20

4100°K - Lumière neutre - Neutral light

2016 - LALIQUE & DELISLE

Détails techniques et instructions de montage : cf fiche architecture. / Technical datas & mounting instructions: see architecture files.

APPLIQUES - WALL SCONCES

GINKGO
MM / MS



5,5 kg / 12.13 pounds

Incolore / Clear
Chromé / Chrome



Incolore / Clear
Doré / Gilded

FINITION / FINISHING

REFERENCE

EAN CODE



CRISTAL INCOLORE - CLEAR CRYSTAL
NICKEL - NICKEL

EUROPE
10578700



CRISTAL INCOLORE - CLEAR CRYSTAL
NICKEL - NICKEL

US
10578800



CRISTAL INCOLORE - CLEAR CRYSTAL
DORÉ - GILDED

EUROPE
10578900



CRISTAL INCOLORE - CLEAR CRYSTAL
DORÉ - GILDED

US
10579000



E14 x 2

CE IP20

4100°K - Lumière neutre - Neutral light

2017 - LALIQUE ET DELISLE

Détails techniques et instructions de montage : cf fiche architecture. / Technical datas & mounting instructions: see architecture files.

APPLIQUES - WALL SCONCES

GINKGO GM / LS



FINITION / FINISHING



CRISTAL INCOLORE - CLEAR CRYSTAL
NICKEL - NICKEL

REFERENCE

EUROPE
10578300

EAN CODE



CRISTAL INCOLORE - CLEAR CRYSTAL
NICKEL - NICKEL

US
10578400



CRISTAL INCOLORE - CLEAR CRYSTAL
DORÉ - GILDED

EUROPE
10578500



CRISTAL INCOLORE - CLEAR CRYSTAL
DORÉ - GILDED

US
10578600



E14 x 4

CE IP20

4100°K - Lumière neutre - Neutral light

2017 - LALIQUE & DELISLE

Détails techniques et instructions de montage : cf fiche architecture. / Technical datas & mounting instructions: see architecture files.



Incolore / Clear
Doré / Gilded

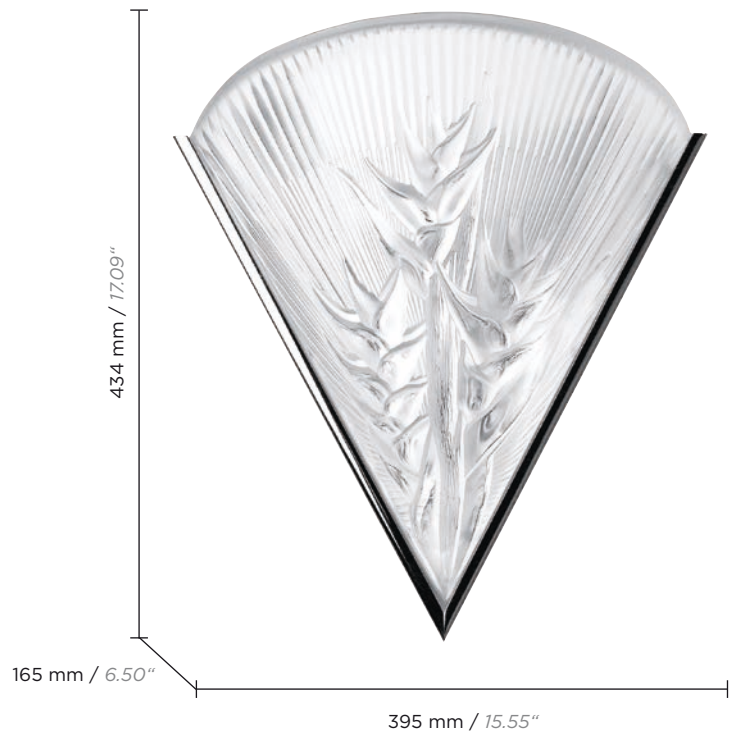

8,4 kg / 18.52 pounds

Incolore / Clear
Chromé / Chrome

FINITION / FINISHING



CRISTAL INCOLORE - CLEAR CRYSTAL
CHROMÉ - CHROME

REFERENCE

EUROPE
1002100

EAN CODE



CRISTAL INCOLORE - CLEAR CRYSTAL
CHROMÉ - CHROME

US
1002199



CRISTAL INCOLORE - CLEAR CRYSTAL
DORÉ - GILDED

EUROPE
1002200



CRISTAL INCOLORE - CLEAR CRYSTAL
DORÉ - GILDED

US
1002299



E14 x 1



IP20

2700°K - Lumière chaude - Warm light

1992 - Marie-Claude Lalique

Détails techniques et instructions de montage : cf fiche architecture. / Technical datas & mounting instructions: see architecture files.

APPLIQUES - WALL SCONCES

KORA CRISTALIGHT



403 mm / 15.87"

171 mm / 6.73"

106 mm / 4.17"

8,4 kg / 18.52 pounds

Incolore / Clear
Chromé / Chrome



Incolore / Clear
Doré / Gilded

FINITION / FINISHING

REFERENCE

EAN CODE



CRISTAL INCOLORE - CLEAR CRYSTAL
CHROMÉ - CHROME

EUROPE
10177700



CRISTAL INCOLORE - CLEAR CRYSTAL
CHROMÉ - CHROME

US
10177800



CRISTAL INCOLORE - CLEAR CRYSTAL
DORÉ - GILDED

EUROPE
10177900



CRISTAL INCOLORE - CLEAR CRYSTAL
DORÉ - GILDED

US
10178000



BANDES / STRIPS LED x 3 - 12 watts - 520 lumens

CE IP20

4100°K - Lumière neutre - Neutral light

2011 - LALIQUE

Détails techniques et instructions de montage : cf fiche architecture. / Technical datas & mounting instructions: see architecture files.

APPLIQUES - WALL SCONCES

ORGUE



0,75 kg / 1.65 pounds

1 cristal / 1 crystal
Incolore / Clear
Chromé / Chrome



2,8 kg / 6.17 pounds

5 cristaux / 5 crystals
Incolore / Clear
Doré / Gilded

FINITION / FINISHING

REFERENCE

EAN CODE



1 CRISTAL / 1 CRYSTAL



CRISTAL INCOLORE - CLEAR CRYSTAL
CHROMÉ - CHROME

EUROPE
10152900



CRISTAL INCOLORE - CLEAR CRYSTAL
CHROMÉ - CHROME

US
10157600



CRISTAL INCOLORE - CLEAR CRYSTAL
DORÉ - GILDED

EUROPE
10157700



CRISTAL INCOLORE - CLEAR CRYSTAL
DORÉ - GILDED

US
10157800



2011 - STUDIO ANDRÉE PUTMAN POUR LALIQUE



TRIO LED x 1 - 3 watts - 280 lumens



4100°K - Lumière neutre - Neutral light

Détails techniques et instructions de montage : cf fiche architecture. / Technical datas & mounting instructions: see architecture files.

FINITION / FINISHING

REFERENCE

EAN CODE



5 CRISTAUX / 5 CRYSTALS



CRISTAL INCOLORE - CLEAR CRYSTAL
CHROMÉ - CHROME

EUROPE
10153000



CRISTAL INCOLORE - CLEAR CRYSTAL
CHROMÉ - CHROME

US
10157900



CRISTAL INCOLORE - CLEAR CRYSTAL
DORÉ - GILDED

EUROPE
10158000



CRISTAL INCOLORE - CLEAR CRYSTAL
DORÉ - GILDED

US
10158100



2011 - STUDIO ANDRÉE PUTMAN POUR LALIQUE



LED x 5 - 18 watts - 850 lumens



4100°K - Lumière neutre - Neutral light

Détails techniques et instructions de montage : cf fiche architecture. / Technical datas & mounting instructions: see architecture files.

APPLIQUES - WALL SCONCES

PALME



2,1 kg / 4.63 pounds

Incolore / Clear
Chromé / Chrome



Incolore / Clear
Doré / Gilded

FINITION / FINISHING

REFERENCE

EAN CODE



CRISTAL INCOLORE - CLEAR CRYSTAL
CHROMÉ - CHROME

EUROPE
1000800



CRISTAL INCOLORE - CLEAR CRYSTAL
CHROMÉ - CHROME

US
1000899



CRISTAL INCOLORE - CLEAR CRYSTAL
DORÉ - GILDED

EUROPE
1004000



CRISTAL INCOLORE - CLEAR CRYSTAL
DORÉ - GILDED

US
1004099



E14 x 1

CE IP20

2700°K - Lumière chaude - Warm light

1947 - Marc Lalique

Détails techniques et instructions de montage : cf fiche architecture. / Technical datas & mounting instructions: see architecture files.

SERENE PRISME DOUBLE / DOUBLE PRISM

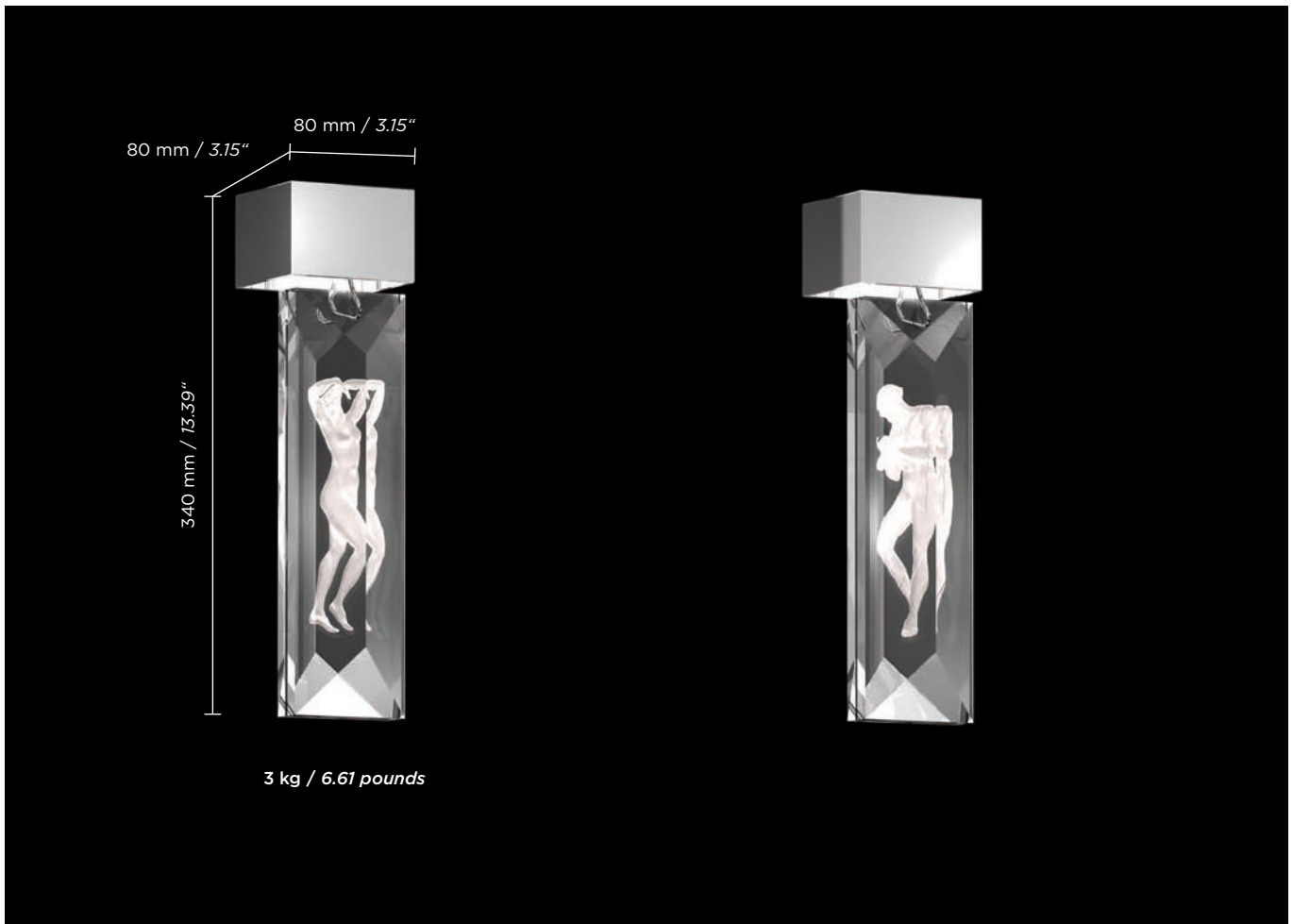

FINITION / FINISHING	REFERENCE	EAN CODE
DAHLIA  CRISTAL INCOLORE CLEAR CRYSTAL	10434800	0 90592 91583 7
FIGURINES  CRISTAL INCOLORE CLEAR CRYSTAL	10434700	0 90592 91584 4



Bronze / Bronze



Nickel (plaqué) / Nickel (plated)



Or (plaqué) / Gold (plated)

3 finitions de montage disponibles. Merci de préciser la finition souhaitée lors de la commande.
3 available mounting finishing. Please specify the desired finishing when ordering.



LED G4 - 1,5 watts - 90 lumens

CE IP30

2700°K - Lumière chaude - Warm light

Luminaire non gradable. / Non dimmable lighting.

2014 - WINDFALL & LALIQUE

Détails techniques et instructions de montage : cf fiche architecture. / Technical datas & mounting instructions: see architecture files.
Hauteur réglable. Pas de drop minimum. / Height adjustable. No minimum drop.

Compositions de cristal et finitions métal réalisables sur mesure. / Bespoke crystal and metal finishing customized choice available upon request.

APPLIQUES - WALL SCONCES

SERENE 4 PRISMES / 4 PRISMS

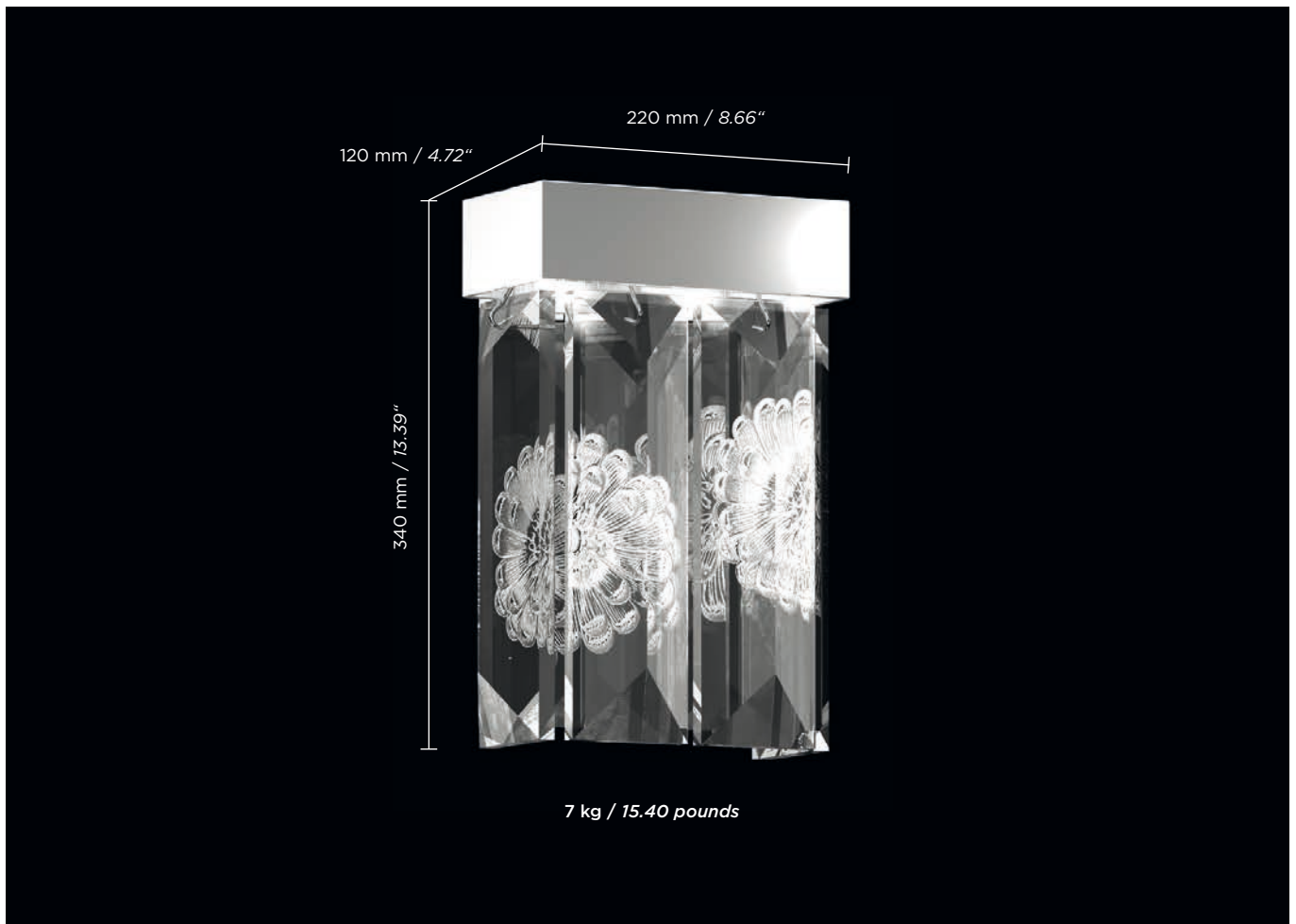

FINITION / FINISHING	REFERENCE	EAN CODE
DAHLIA  CRISTAL INCOLORE CLEAR CRYSTAL	10435000	 0 90592 91581 3
FIGURINES  CRISTAL INCOLORE CLEAR CRYSTAL	10434900	 0 90592 91582 0



3 finitions de montage disponibles. Merci de préciser la finition souhaitée lors de la commande.
3 available mounting finishing. Please specify the desired finishing when ordering.



LED G4 - 4,5 watts - 270 lumens

CE IP30

2700°K - Lumière chaude - Warm light

Luminaire non gradable. / Non dimmable lighting.

2014 - WINDFALL & LALIQUE

Détails techniques et instructions de montage : cf fiche architecture. / Technical datas & mounting instructions: see architecture files.
Hauteur réglable. Pas de drop minimum. / Height adjustable. No minimum drop.

Compositions de cristal et finitions métal réalisables sur mesure. / Bespoke crystal and metal finishing customized choice available upon request.

APPLIQUES - WALL SCONCES

SERENE

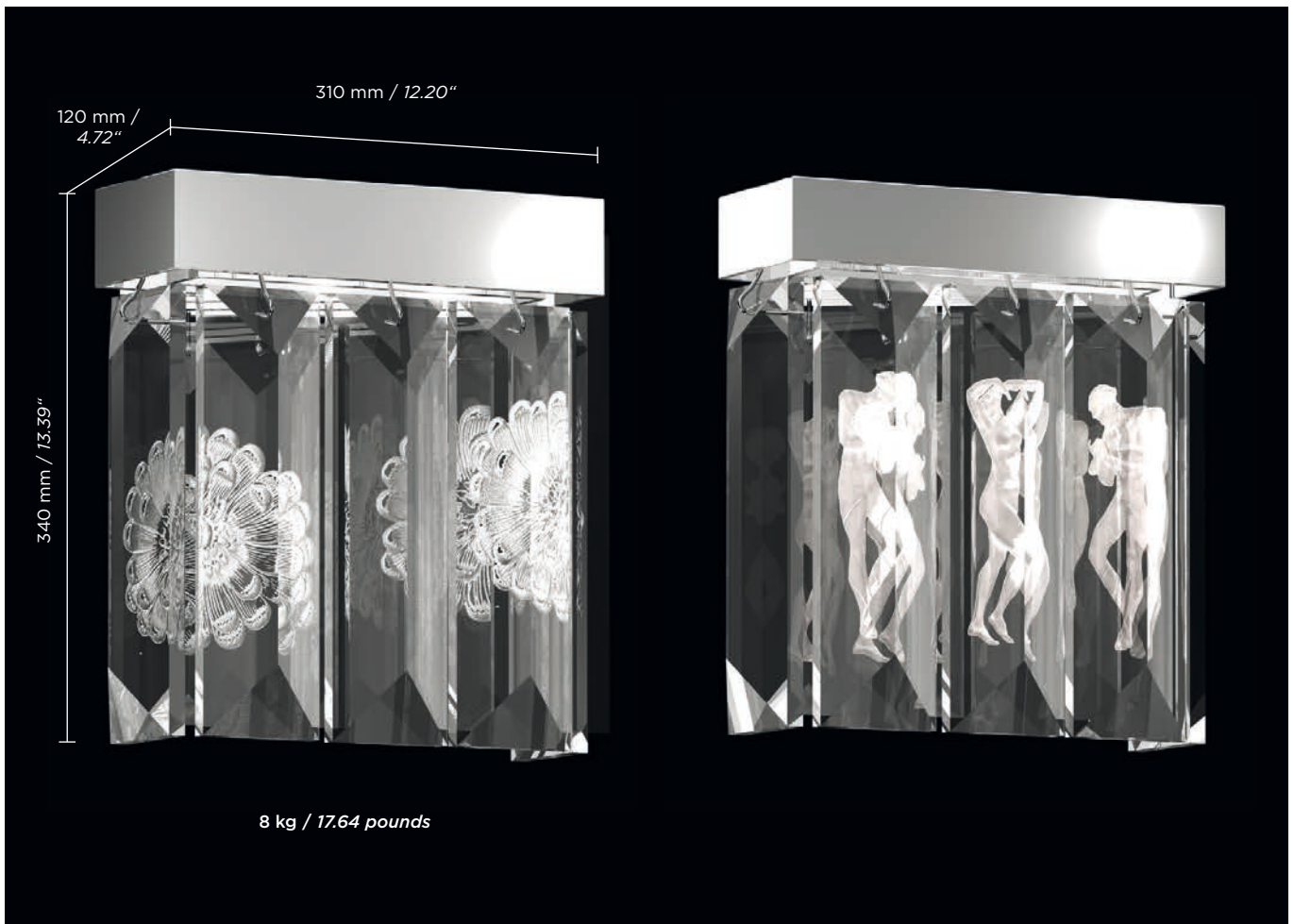

5 PRISMES, RECTANGULAIRE / 5 PRISMS, RECTANGULAR



FINITION / FINISHING	REFERENCE	EAN CODE
DAHLIA  CRISTAL INCOLORE CLEAR CRYSTAL	10435200	 0 90592 91579 0
FIGURINES  CRISTAL INCOLORE CLEAR CRYSTAL	10435100	 0 90592 91580 6



3 finitions de montage disponibles. Merci de préciser la finition souhaitée lors de la commande.
 3 available mounting finishing. Please specify the desired finishing when ordering.

	LED G4 - 6 watts - 360 lumens	 IP30	2700°K - Lumière chaude - Warm light	Luminaire non gradable. / Non dimmable lighting.
---	-------------------------------	---	--------------------------------------	--

2014 - WINDFALL & LALIQUE

Détails techniques et instructions de montage : cf fiche architecture. / Technical datas & mounting instructions: see architecture files.
 Hauteur réglable. Pas de drop minimum. / Height adjustable. No minimum drop.
 Compositions de cristal et finitions métal réalisables sur mesure. / Bespoke crystal and metal finishing customized choice available upon request.

APPLIQUES - WALL SCONCES

SERENE 5 PRISMES, CIRCULAIRE / 5 PRISMS, CIRCULAR

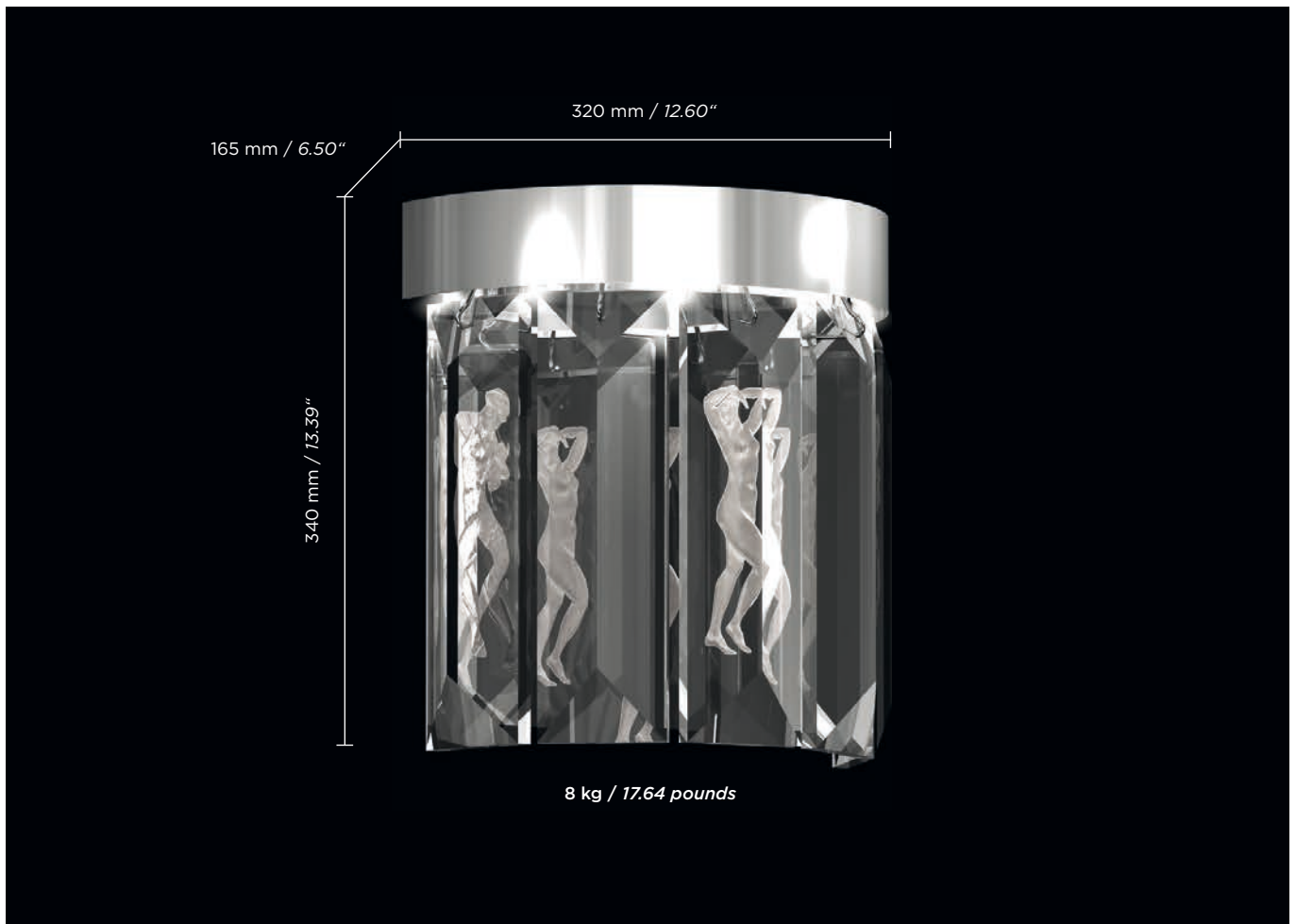

FINITION / FINISHING	REFERENCE	EAN CODE
DAHLIA  CRISTAL INCOLORE CLEAR CRYSTAL	10435400	0 90592 91577 6
FIGURINES  CRISTAL INCOLORE CLEAR CRYSTAL	10435300	0 90592 91578 3



Bronze / Bronze



Nickel (plaqué) / Nickel (plated)



Or (plaqué) / Gold (plated)

3 finitions de montage disponibles. Merci de préciser la finition souhaitée lors de la commande.
3 available mounting finishing. Please specify the desired finishing when ordering.



LED G4 - 6 watts - 360 lumens

CE IP30

2700°K - Lumière chaude - Warm light

Luminaire non gradable. / Non dimmable lighting.

2014 - WINDFALL & LALIQUE

Détails techniques et instructions de montage : cf fiche architecture. / Technical datas & mounting instructions: see architecture files.
Hauteur réglable. Pas de drop minimum. / Height adjustable. No minimum drop.





Compositions de cristal et finitions métal réalisables sur mesure. / Bespoke crystal and metal finishing customized choice available upon request.

APPLIQUES - WALL SCONCES

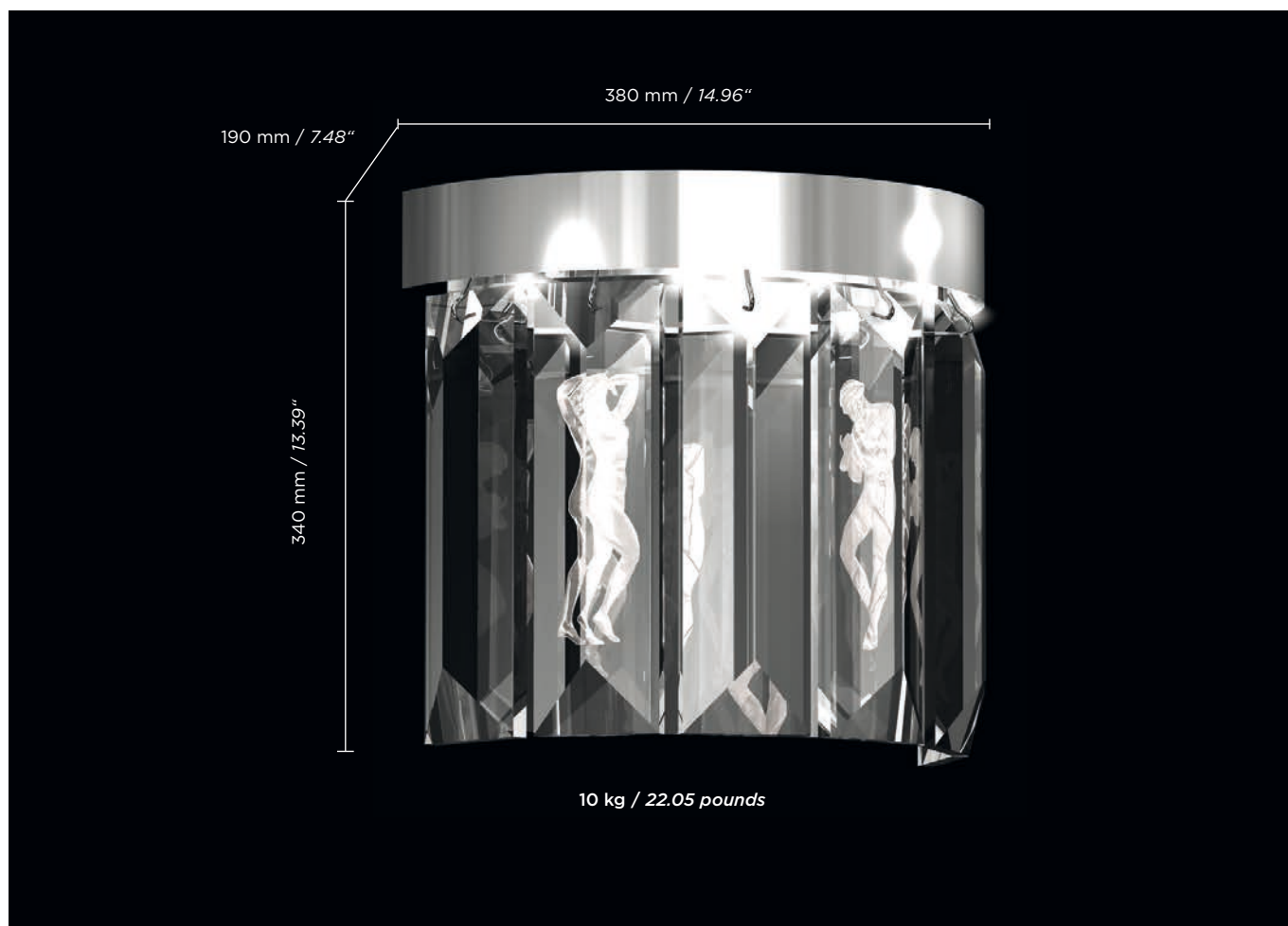
SERENE



6 PRISMES, CIRCULAIRE / 6 PRISMS, CIRCULAR

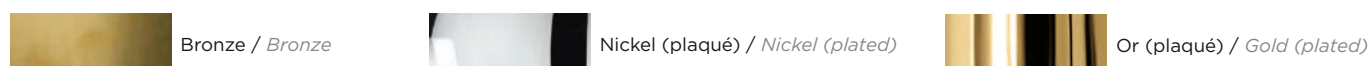

FINITION / FINISHING	REFERENCE	EAN CODE
DAHLIA  CRISTAL INCOLORE CLEAR CRYSTAL	10435600	 0 90592 91575 2
FIGURINES  CRISTAL INCOLORE CLEAR CRYSTAL	10435500	 0 90592 91576 9



3 finitions de monture disponibles. Merci de préciser la finition souhaitée lors de la commande.
3 available mounting finishing. Please specify the desired finishing when ordering.

 LED G4 - 7,5 watts - 450 lumens  **IP30** 2700°K - Lumière chaude - Warm light Luminaire non gradable. / Non dimmable lighting.

2014 - WINDFALL & LALIQUE

Détails techniques et instructions de montage : cf fiche architecture. / Technical datas & mounting instructions: see architecture files.
Hauteur réglable. Pas de drop minimum. / Height adjustable. No minimum drop.

Compositions de cristal et finitions métal réalisables sur mesure. / Bespoke crystal and metal finishing customized choice available upon request.

APPLIQUES - WALL SCONCES

SÉVILLE 1 RANG / 1 TIER



FINITION / FINISHING

REFERENCE

EAN CODE



CRISTAL INCOLORE - CLEAR CRYSTAL
CHROMÉ - CHROME

EUROPE
1000200



CRISTAL INCOLORE - CLEAR CRYSTAL
CHROMÉ - CHROME

US
1000299



CRISTAL INCOLORE - CLEAR CRYSTAL
DORÉ - GILDED

EUROPE
1001600



CRISTAL INCOLORE - CLEAR CRYSTAL
DORÉ - GILDED

US
1001699



1947 - Marc Lalique



CRISTAL INCOLORE ET NOIR - CLEAR AND BLACK CRYSTAL
CHROMÉ - CHROME

EUROPE
1000500



CRISTAL INCOLORE ET NOIR - CLEAR AND BLACK CRYSTAL
CHROMÉ - CHROME

US
1000599



2007 - LALIQUE



E14 x 1

CE IP20

2700°K - Lumière chaude - Warm light

Détails techniques et instructions de montage : cf fiche architecture. / Technical datas & mounting instructions: see architecture files.



FINITION / FINISHING



CRISTAL INCOLORE - CLEAR CRYSTAL
CHROMÉ - CHROME



CRISTAL INCOLORE - CLEAR CRYSTAL
CHROMÉ - CHROME

REFERENCE

EUROPE
10552400

US
10552500

EAN CODE



LED 28 - 9 watts - 730 lumens



2700°K - Lumière chaude - Warm light à / to 4100°K - Lumière neutre - Neutral light

2017 - LALIQUE

Détails techniques et instructions de montage : cf fiche architecture. / Technical datas & mounting instructions: see architecture files.

FAUNES



Ø 200 mm / 7.87"
5,79 kg / 12.76 pounds

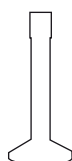

LAMPE HORS ABAT-JOUR

Hauteur x Diamètre - Poids :
500 x 200 mm - 5,4 kg

LAMP WITHOUT LAMPSHADE

Height x Diameter - Weight:
19.69" x 7.87" - 11.90 pounds

FINITION / FINISHING



CRISTAL INCOLORE - CLEAR CRYSTAL
CHROMÉ - CHROME



CRISTAL INCOLORE - CLEAR CRYSTAL
CHROMÉ - CHROME

REFERENCE

EUROPE
1150000

US
1150099

EAN CODE



E27 x 1

CE IP20

2700°K - Lumière chaude - Warm light

Lampe livrée sans abat-jour. / Lamp delivered without lampshade.

1997 - LALIQUE

Détails techniques et instructions de montage : cf fiche architecture. / Technical datas & mounting instructions: see architecture files.



ABAT-JOUR CYLINDRIQUE

Hauteur x Diamètre - Poids :
210 mm x 470 mm - 0,39 kg

LAMPSHADE CYLINDRICAL

Height x Diameter - Weight:
8.27" x 18.50" - 0.86 pounds

FINITION / FINISHING

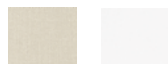

CRÈME / INTÉRIEUR BLANC
CREAM / INSIDE WHITE



NOIR / INTÉRIEUR ARGENT
BLACK / INSIDE SILVER

REFERENCE

10031700

10059600

EAN CODE



2008 - LALIQUE



Incolore / Clear
Doré / Gilded

4 kg / 8.82 pounds

Incolore / Clear
Chromé / Chrome

FINITION / FINISHING

REFERENCE

EAN CODE



CRISTAL INCOLORE - CLEAR CRYSTAL
NICKEL - NICKEL

EUROPE
10579100



CRISTAL INCOLORE - CLEAR CRYSTAL
NICKEL - NICKEL

US
10579200



CRISTAL INCOLORE - CLEAR CRYSTAL
DORÉ - GILDED

EUROPE
10579300



CRISTAL INCOLORE - CLEAR CRYSTAL
DORÉ - GILDED

US
10579400



 E14 x 2 - 520 lumens

CE IP20 4000°K - Lumière neutre - Neutral light

2017 - LALIQUE & DELISLE

Détails techniques et instructions de montage : cf fiche architecture. / Technical datas & mounting instructions: see architecture files.

HIRONDELLES



FINITION / FINISHING



CRISTAL INCOLORE - CLEAR CRYSTAL
CHROMÉ - CHROME

REFERENCE

EUROPE
10648800

EAN CODE



CRISTAL INCOLORE - CLEAR CRYSTAL
CHROMÉ - CHROME

US
10648900



CRISTAL BLEU SAPHIR - SAPPHIRE BLUE CRYSTAL
CHROMÉ - CHROME

EUROPE
10649000



CRISTAL BLEU SAPHIR - SAPPHIRE BLUE CRYSTAL
CHROMÉ - CHROME

US
10649100



1 LED **CE** IP20

2700°K - Lumière chaude - Warm light

2018 - LALIQUE

Détails techniques : cf fiche d'identité. / Technical datas : see identity file files.

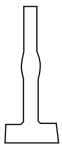

LAMPE HORS ABAT-JOUR

Hauteur x Largeur - Poids :
420 x 155 mm - 2,4 kg

LAMP WITHOUT LAMPSHADE

Height x Width - Weight:
16.54" x 6.10" - 5.29 pounds

FINITION / FINISHING



CRISTAL INCOLORE - CLEAR CRYSTAL
DORÉ - GILDED



CRISTAL INCOLORE - CLEAR CRYSTAL
DORÉ - GILDED

REFERENCE

EUROPE
1145300

US
1145399

EAN CODE



E14 x 2

CE IP20

2700°K - Lumière chaude - Warm light

Lampe livrée sans abat-jour. / Lamp delivered without lampshade.

1948 - Marc Lalique

Détails techniques et instructions de montage : cf fiche architecture. / Technical datas & mounting instructions: see architecture files.



ABAT-JOUR

Hauteur x Diamètre - Poids :
300 mm x 510 mm - 0,35 kg

LAMPSHADE

Height x Diameter - Weight:
11.81" x 20.08" - 0.77 pounds

FINITION / FINISHING

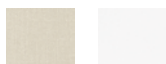

CRÈME / INTÉRIEUR BLANC
CREAM / INSIDE WHITE



NOIR / INTÉRIEUR BLANC
BLACK / INSIDE WHITE

REFERENCE

0145320

0145330

EAN CODE



2008 - LALIQUE

MASQUE DE FEMME



FINITION / FINISHING



CRISTAL INCOLORE - CLEAR CRYSTAL
CHROMÉ - CHROME



CRISTAL INCOLORE - CLEAR CRYSTAL
CHROMÉ - CHROME

REFERENCE

EUROPE
10552000

US
10552100

EAN CODE



BANDES LED - 16 watts - 580 lumens

CE IP20

2700°K - Lumière chaude - Warm light à / to 4100°K - Lumière neutre - Neutral light

2017 - LALIQUE

Détails techniques et instructions de montage : cf fiche architecture. / Technical datas & mounting instructions: see architecture files.



3,7 kg / 8.16 pounds

FINITION / FINISHING



CRISTAL INCOLORE
CLEAR CRYSTAL

CRISTAL INCOLORE
CLEAR CRYSTAL

REFERENCE

EUROPE
1150900

US
1150999

EAN CODE



E14 x 1

CE IP20

2700°K - Lumière chaude - Warm light

2005 - LALIQUE

Détails techniques et instructions de montage : cf fiche architecture. / Technical datas & mounting instructions: see architecture files.

POSÉIDON

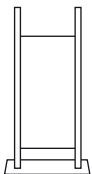

LAMPE HORS ABAT-JOUR

Hauteur x Longueur x Largeur - Poids :
430 x 200 x 120 mm - 2,85 kg

LAMP WITHOUT LAMPSHADE

Height x Length x Width - Weight:
16.93" x 7.87" x 4.72" - 6.28 pounds

200 mm / 7.87"

3,27 kg / 7.21 pounds

FINITION / FINISHING



CRISTAL INCOLORE - CLEAR CRYSTAL
CHROMÉ - CHROME



CRISTAL INCOLORE - CLEAR CRYSTAL
CHROMÉ - CHROME

REFERENCE

EUROPE
1150800

US
1150899

EAN CODE



E27 x 1

CE IP20

2700°K - Lumière chaude - Warm light

Lampe livrée sans abat-jour. / Lamp delivered without lampshade.

2004 - LALIQUÉ

Détails techniques et instructions de montage : cf fiche architecture. / Technical datas & mounting instructions: see architecture files.

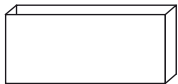

ABAT-JOUR

Hauteur x Longueur x Largeur - Poids :
140 x 370 x 120 mm - 0,42 kg

LAMPSHADE

Height x Length x Width - Weight:
5.51" x 14.57" x 4.72" - 0.93 pounds

FINITION / FINISHING



PERCALINE CRÈME / INTÉRIEUR ARGENT
CREAM PERCALINE COTTON / INSIDE SILVER



PERCALINE NOIRE / INTÉRIEUR ARGENT
BLACK PERCALINE COTTON / INSIDE SILVER

REFERENCE

0150850

0150840

EAN CODE



2007 - LALIQUÉ

SERENE
6 PRISMES, CIRCULAIRE / 6 PRISMS, CIRCULAR

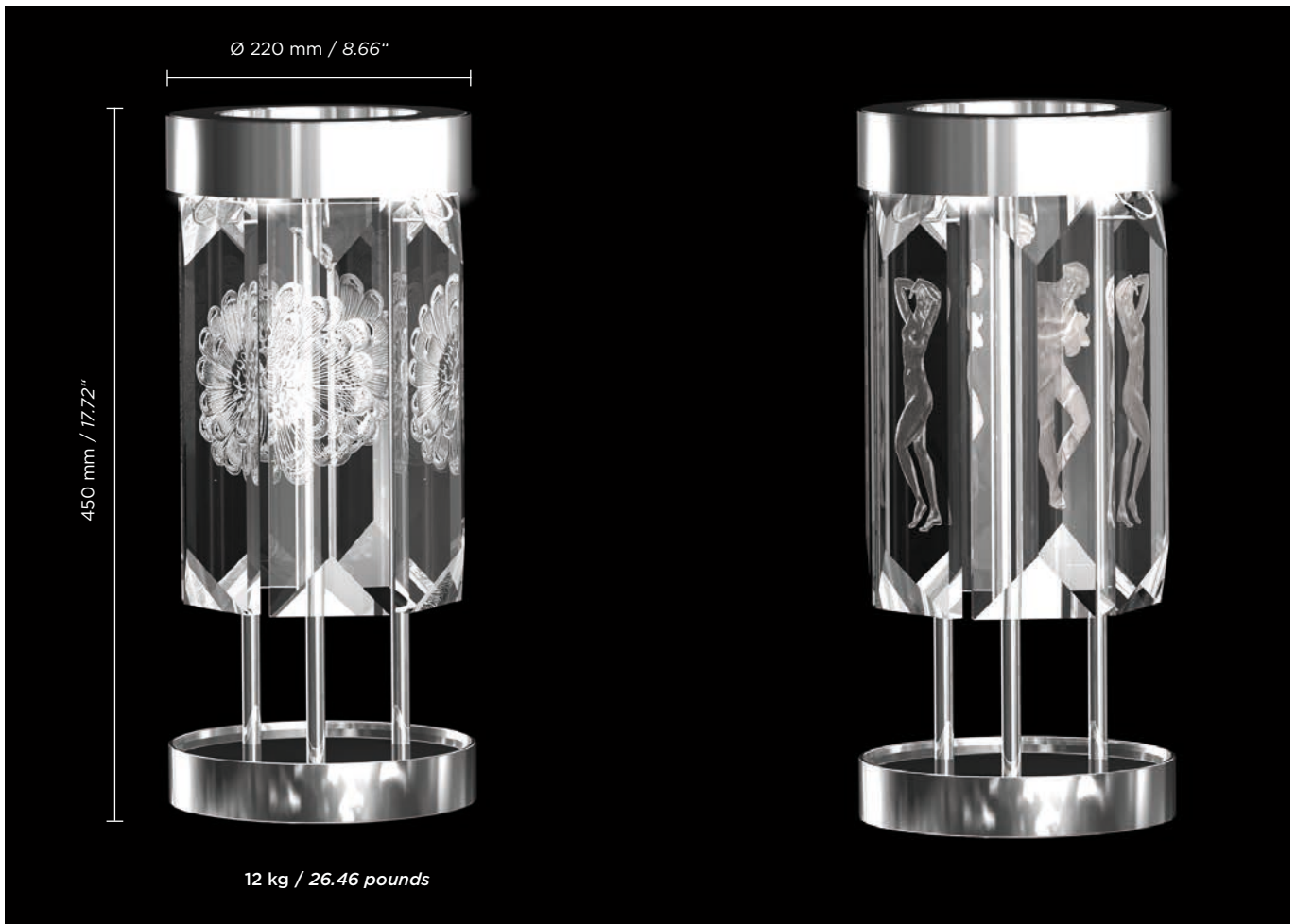

FINITION / FINISHING	REFERENCE	EAN CODE
DAHLIA  CRISTAL INCOLORE CLEAR CRYSTAL	10432200	 0 90592 91610 0
FIGURINES  CRISTAL INCOLORE CLEAR CRYSTAL	10432300	 0 90592 91559 2



Bronze / Bronze



Nickel (plaqué) / Nickel (plated)



Or (plaqué) / Gold (plated)

3 finitions de monture disponibles. Merci de préciser la finition souhaitée lors de la commande.
 3 available mounting finishing. Please specify the desired finishing when ordering.



LED G4 - 9 watts - 540 lumens

CE IP30 2700°K - Lumière chaude - Warm light

Luminaire non gradable. / Non dimmable lighting.

2014 - WINDFALL & LALIQUE

Détails techniques et instructions de montage : cf fiche architecture. / Technical datas & mounting instructions: see architecture files.

Hauteur réglable. Pas de drop minimum. / Height adjustable. No minimum drop.

Compositions de cristal et finitions métal réalisables sur mesure. / Bespoke crystal and metal finishing customized choice available upon request.

VERSAILLES



LAMPE HORS ABAT-JOUR

Hauteur x Largeur - Poids :
450 x 230 mm - 9,4 kg

LAMP WITHOUT LAMPSHADE

Height x Width - Weight:
17.72" x 9.06" - 20.72 pounds

FINITION / FINISHING



CRISTAL INCOLORE - CLEAR CRYSTAL
CHROMÉ - CHROME



CRISTAL INCOLORE - CLEAR CRYSTAL
CHROMÉ - CHROME

REFERENCE

EUROPE
1153800

US
1153899

EAN CODE



E27 x 1

CE IP20

2700°K - Lumière chaude - Warm light

Lampe livrée sans abat-jour. / Lamp delivered without lampshade.

2006 - LALIQUE

Détails techniques et instructions de montage : cf fiche architecture. / Technical datas & mounting instructions: see architecture files.



ABAT-JOUR

Hauteur x Diamètre - Poids :
320 x 450 mm - 0,51 kg

LAMPSHADE

Height x Diameter - Weight:
12.60" x 17.72" - 1.12 pounds

FINITION / FINISHING

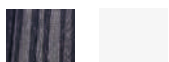

MOUSSELINE NOIRE / INTÉRIEUR BLANC
BLACK MUSLIN / INSIDE WHITE

REFERENCE

0153800

EAN CODE



2006 - LALIQUE

LANTERNES - LANTERNS

COUTARD
PM / SS

ÉDITION NUMÉROTÉE / *NUMBERED EDITION*



Incolore / *Clear*
Noir mat / *Matte black*

FINITION / *FINISHING*

REFERENCE

EAN CODE

	CRISTAL INCOLORE - <i>CLEAR CRYSTAL</i> NICKEL - <i>NICKEL</i>	EUROPE 10642700	0 90592 89361 6
	CRISTAL INCOLORE - <i>CLEAR CRYSTAL</i> NICKEL - <i>NICKEL</i>	US 10642800	0 90592 89359 3
	CRISTAL INCOLORE - <i>CLEAR CRYSTAL</i> NOIR MAT - <i>MATTE BLACK</i>	EUROPE 10642900	0 90592 89357 9
	CRISTAL INCOLORE - <i>CLEAR CRYSTAL</i> NOIR MAT - <i>MATTE BLACK</i>	US 10643000	0 90592 89356 2
	CRISTAL INCOLORE - <i>CLEAR CRYSTAL</i> DORÉ - <i>GILDED</i>	EUROPE 10643100	0 90592 89355 5
	CRISTAL INCOLORE - <i>CLEAR CRYSTAL</i> DORÉ - <i>GILDED</i>	US 10643200	0 90592 89354 8



Bande LED - *LED stripe* - 100 watts



IP20

2700°K - Lumière chaude - *Warm light*

2018 - PIERRE-YVES ROCHON POUR LALIQUE

Détails techniques et instructions de montage : cf fiche architecture. / *Technical datas & mounting instructions: see architecture files.*

Préciser la hauteur totale du lustre à la commande. / *Precise the total height of the chandelier when ordering.*

Éclairage gradable avec télécommande ou domotique (sur demande). / *Dimmable lighting with remote control or home automation (bespoke order).*

LANTERNES - LANTERNS

COUTARD

GM / LS

ÉDITION NUMÉROTÉE / NUMBERED EDITION

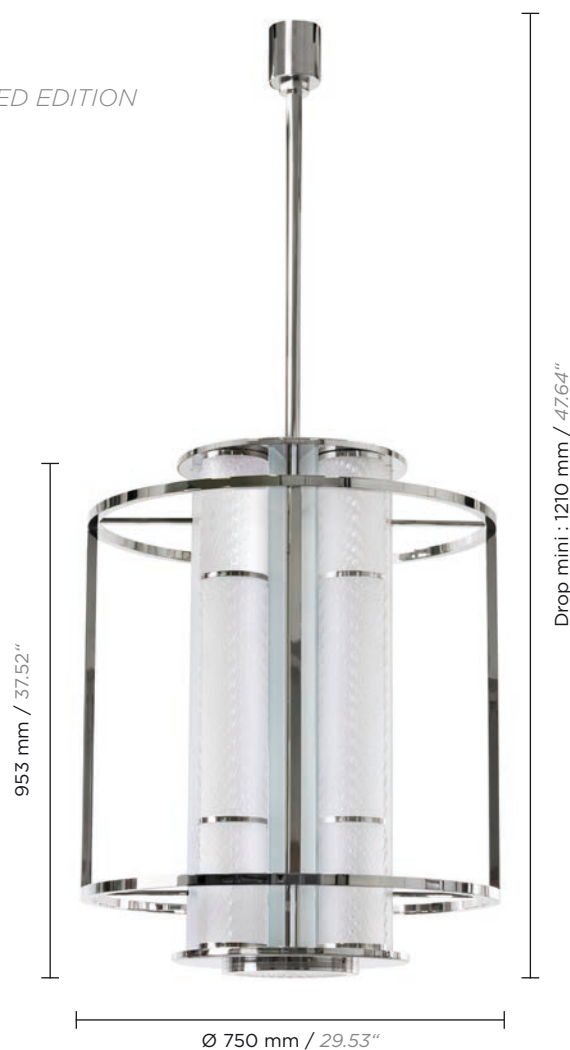

Ø 750 mm / 29.53"

90 kg / 198.42 pounds

Incolore / Clear
Chromé / Chrome

FINITION / FINISHING		REFERENCE	EAN CODE
	CRISTAL INCOLORE - CLEAR CRYSTAL NICKEL - NICKEL	EUROPE 10642300	 0 90592 89366 1
	CRISTAL INCOLORE - CLEAR CRYSTAL NICKEL - NICKEL	US 10642400	 0 90592 89365 4
	CRISTAL INCOLORE - CLEAR CRYSTAL NOIR MAT - MATTE BLACK	EUROPE 10642500	 0 90592 89364 7
	CRISTAL INCOLORE - CLEAR CRYSTAL NOIR MAT - MATTE BLACK	US 10642600	 0 90592 89362 3
	CRISTAL INCOLORE - CLEAR CRYSTAL DORÉ - GILDED	EUROPE 10656700	 0 90592 89166 7
	CRISTAL INCOLORE - CLEAR CRYSTAL DORÉ - GILDED	US 10656800	 0 90592 89165 0



Bande LED - LED stripe - 185 watts



IP20 2700°K - Lumière chaude - Warm light

2018 - PIERRE-YVES ROCHON POUR LALIQUE

Détails techniques et instructions de montage : cf fiche architecture. / Technical datas & mounting instructions: see architecture files.

Préciser la hauteur totale du lustre à la commande. / Precise the total height of the chandelier when ordering.

Éclairage gradable avec télécommande ou domotique (sur demande). / Dimmable lighting with remote control or home automation (bespoke order).

LANTERNE - LANTERN

GINKGO



Incolore / Clear
Doré / Gilded

830 mm / 32.68"



Incolore / Clear
Chromé / Chrome

Drop mini : 990 mm / 38.98"

Ø 410 mm / 16.14"

21 kg / 46.30 pounds

FINITION / FINISHING



CRISTAL INCOLORE - CLEAR CRYSTAL
NICKEL - NICKEL

REFERENCE

EUROPE
10579500

EAN CODE



CRISTAL INCOLORE - CLEAR CRYSTAL
NICKEL - NICKEL

US
10579600



CRISTAL INCOLORE - CLEAR CRYSTAL
DORÉ - GILDED

EUROPE
10579700



CRISTAL INCOLORE - CLEAR CRYSTAL
DORÉ - GILDED

US
10579800



E27 x 3 - 6 watts - 520 lumens

CE IP20

4000°K - Lumière neutre - Neutral light

2017 - LALIQUE & DELISLE

Détails techniques et instructions de montage : cf fiche architecture. / Technical datas & mounting instructions: see architecture files.

LUSTRES - CHANDELIERS

CHAMPS-ÉLYSÉES 1 RANG / 1 TIER



Lustré or / Gold luster
Doré / Gilded



255 mm / 10.04"

Drop mini : 330 mm / 12.99"

Ø 560 mm / 22.05"

19,5 kg / 42.99 pounds

Incolore / Clear
Chromé / Chrome



Incolore / Clear
Doré / Gilded

FINITION / FINISHING

REFERENCE

EAN CODE



CRISTAL INCOLORE - CLEAR CRYSTAL
CHROMÉ - CHROME

EUROPE
1011294



CRISTAL INCOLORE - CLEAR CRYSTAL
CHROMÉ - CHROME

US
1011297



CRISTAL INCOLORE - CLEAR CRYSTAL
DORÉ - GILDED

EUROPE
1011494



CRISTAL INCOLORE - CLEAR CRYSTAL
DORÉ - GILDED

US
1011497



2001 - LALIQUÉ



CRISTAL LUSTRÉ OR - GOLD LUSTER CRYSTAL
DORÉ - GILDED

EUROPE
10544800



CRISTAL LUSTRÉ OR - GOLD LUSTER CRYSTAL
DORÉ - GILDED

US
10544900



2016 - LALIQUÉ



E14 x 6

CE IP20

2700°K - Lumière chaude - Warm light

Détails techniques et instructions de montage : cf fiche architecture. / Technical datas & mounting instructions: see architecture files.
Préciser la hauteur totale du lustre à la commande (minimum 330 mm). / Precise the total height of the chandelier when ordering (12.99 inches minimum).

LUSTRES - CHANDELIERS

CHAMPS-ÉLYSÉES 2 RANGS / 2 TIERS

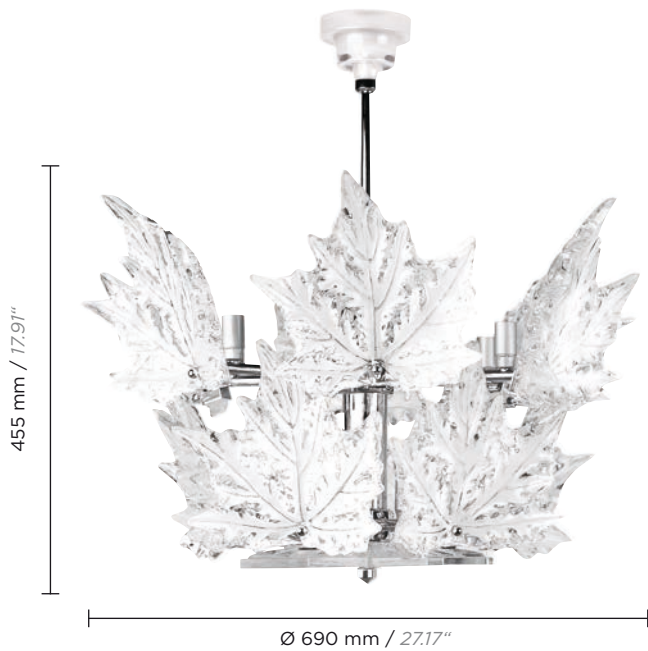

38 kg / 83.78 pounds

Incolore / Clear
Chromé / Chrome



Lustré or / Gold luster
Doré / Gilded

FINITION / FINISHING

	REFERENCE	EAN CODE
	EUROPE 1011394	
	US 1011397	
	EUROPE 1011594	
	US 1011597	
2001 - LALIQUE		
	EUROPE 10545000	
	US 10545100	

2016 - LALIQUE



E14 x 12

CE IP20

2700°K - Lumière chaude - Warm light

Détails techniques et instructions de montage : cf fiche architecture. / Technical datas & mounting instructions: see architecture files.
Préciser la hauteur totale du lustre à la commande (minimum 510 mm). / Precise the total height of the chandelier when ordering (20.08 inches minimum)

LUSTRES - CHANDELIERS

CHAMPS-ÉLYSÉES 3 RANGS / 3 TIERS



Ø 840 mm / 33.07

55 kg / 121.25 pounds

Incolore / Clear
Chromé / Chrome



Lustré or / Gold luster
Doré / Gilded

FINITION / FINISHING



CRISTAL INCOLORE - CLEAR CRYSTAL
CHROMÉ - CHROME

REFERENCE

EUROPE
1012100

EAN CODE



CRISTAL INCOLORE - CLEAR CRYSTAL
CHROMÉ - CHROME

US
1012199



1957 - Marc Lalique



CRISTAL INCOLORE - CLEAR CRYSTAL
DORÉ - GILDED

EUROPE
1012200



CRISTAL INCOLORE - CLEAR CRYSTAL
DORÉ - GILDED

US
1012299



1993 - LALIQUE



CRISTAL LUSTRÉ OR - GOLD LUSTER CRYSTAL
DORÉ - GILDED

EUROPE
10545200



CRISTAL LUSTRÉ OR - GOLD LUSTER CRYSTAL
DORÉ - GILDED

US
10545300



2016 - LALIQUE



E14 x 18

CE IP20

2700°K - Lumière chaude - Warm light

Détails techniques et instructions de montage : cf fiche architecture. / Technical datas & mounting instructions: see architecture files.
Préciser la hauteur totale du lustre à la commande (minimum 700 mm). / Precise the total height of the chandelier when ordering (27.56 inches minimum).

LUSTRES - CHANDELIERS

CHAMPS-ÉLYSÉES 5 RANGS / 5 TIERS



90 kg / 198.42 pounds

Incolore / Clear
Chromé / Chrome



Lustré or / Gold luster
Doré / Gilded

FINITION / FINISHING

REFERENCE

EAN CODE

	CRISTAL INCOLORE - CLEAR CRYSTAL CHROMÉ - CHROME	EUROPE 10619000	 9
	CRISTAL INCOLORE - CLEAR CRYSTAL CHROMÉ - CHROME	US 10619100	 2
	CRISTAL INCOLORE - CLEAR CRYSTAL DORÉ - GILDED	EUROPE 10619200	 5
	CRISTAL INCOLORE - CLEAR CRYSTAL DORÉ - GILDED	US 10619300	 8
	CRISTAL LUSTRÉ OR - GOLD LUSTER CRYSTAL DORÉ - GILDED	EUROPE 10619400	 1
	CRISTAL LUSTRÉ OR - GOLD LUSTER CRYSTAL DORÉ - GILDED	US 10619500	 4



E14 x 30

CE IP20

2700°K - Lumière chaude - Warm light

2017 - LALIQUE

Détails techniques et instructions de montage : cf fiche architecture. / Technical datas & mounting instructions: see architecture files.

Préciser la hauteur totale du lustre à la commande (minimum 1020 mm). / Precise the total height of the chandelier when ordering (40.16 inches minimum).

LUSTRES - CHANDELIERS

CHAMPS-ÉLYSÉES 6 RANGS / 6 TIERS



110 kg / 242.51 pounds

Incolore / Clear
Chromé / Chrome



Lustré or / Gold luster
Doré / Gilded

FINITION / FINISHING



CRISTAL INCOLORE - CLEAR CRYSTAL
CHROMÉ - CHROME

REFERENCE

EUROPE
1012300

EAN CODE



CRISTAL INCOLORE - CLEAR CRYSTAL
CHROMÉ - CHROME

US
1012399



1995 - LALIQUE



CRISTAL INCOLORE - CLEAR CRYSTAL
DORÉ - GILDED

EUROPE
1012400



CRISTAL INCOLORE - CLEAR CRYSTAL
DORÉ - GILDED

US
1012499



1997 - LALIQUE



CRISTAL LUSTRÉ OR - GOLD LUSTER CRYSTAL
DORÉ - GILDED

EUROPE
10545400



CRISTAL LUSTRÉ OR - GOLD LUSTER CRYSTAL
DORÉ - GILDED

US
10545500



2016 - LALIQUE



E14 x 36

CE IP20

2700°K - Lumière chaude - Warm light

Détails techniques et instructions de montage : cf fiche architecture. / Technical datas & mounting instructions: see architecture files.
Préciser la hauteur totale du lustre à la commande (minimum 1220 mm). / Precise the total height of the chandelier when ordering (48.03 inches minimum).



FINITION / FINISHING

		REFERENCE	EAN CODE
	CRISTAL INCOLORE - CLEAR CRYSTAL CHROMÉ - CHROME	EUROPE 1010200	
	CRISTAL INCOLORE - CLEAR CRYSTAL CHROMÉ - CHROME	US 1010299	
	CRISTAL INCOLORE - CLEAR CRYSTAL DORÉ - GILDED	EUROPE 1011600	
	CRISTAL INCOLORE - CLEAR CRYSTAL DORÉ - GILDED	US 1011699	



E27 x 3

CE IP20

2700°K - Lumière chaude - Warm light

1955 - Marc Lalique

Détails techniques et instructions de montage : cf fiche architecture. / Technical datas & mounting instructions: see architecture files.

Préciser la hauteur totale du lustre à la commande (minimum 440 mm). / Precise the total height of the chandelier when ordering (17.32 inches minimum).

LUSTRES - CHANDELIERS

GINKGO



42,5 kg / 93.70 pounds
Incolore / Clear
Chromé / Chrome



Incolore / Clear
Doré / Gilded

FINITION / FINISHING



CRISTAL INCOLORE - CLEAR CRYSTAL
NICKEL - NICKEL

REFERENCE

EUROPE
10580700

EAN CODE



CRISTAL INCOLORE - CLEAR CRYSTAL
NICKEL - NICKEL

US
10580800



CRISTAL INCOLORE - CLEAR CRYSTAL
DORÉ - GILDED

EUROPE
10580900



CRISTAL INCOLORE - CLEAR CRYSTAL
DORÉ - GILDED

US
10581000



E14 x 3 - 6 watts - 520 lumens

CE IP20

4000°K - Lumière neutre - Neutral light

2016 - LALIQUE & DELISLE

Détails techniques et instructions de montage : cf fiche architecture. / Technical datas & mounting instructions: see architecture files.

LUSTRES - CHANDELIERS

HIRONDELLES PM / SS



Incolore / Clear
Doré / Gilded



Incolore / Clear
Chromé / Chrome

FINITION / FINISHING



CRISTAL INCOLORE - CLEAR CRYSTAL
CHROMÉ - CHROME

REFERENCE

EUROPE
10649400

EAN CODE



CRISTAL INCOLORE - CLEAR CRYSTAL
CHROMÉ - CHROME

US
10649500



CRISTAL INCOLORE - CLEAR CRYSTAL
DORÉ - GILDED

EUROPE
10649600



CRISTAL INCOLORE - CLEAR CRYSTAL
DORÉ - GILDED

US
10649700



E26-E27

CE IP20

2700°K - 4100°K Lumière neutre ou chaude - neutral or warm light

2018 - LALIQUE

Détails techniques et instructions de montage : cf fiche architecture. / Technical datas & mounting instructions: see architecture files.

Préciser la hauteur totale du lustre à la commande (minimum 570 mm). / Precise the total height of the chandelier when ordering (22.44 inches minimum)

LUSTRES - CHANDELIERS

HIRONDELLES GM / LS



Incolore / Clear
Chromé / Chrome



Incolore / Clear
Doré / Gilded

FINITION / FINISHING



CRISTAL INCOLORE - CLEAR CRYSTAL
CHROMÉ - CHROME

REFERENCE

EUROPE
10649800

EAN CODE



CRISTAL INCOLORE - CLEAR CRYSTAL
CHROMÉ - CHROME

US
10649900



CRISTAL INCOLORE - CLEAR CRYSTAL
DORÉ - GILDED

EUROPE
10650000



CRISTAL INCOLORE - CLEAR CRYSTAL
DORÉ - GILDED

US
10650100



E26-E27

CE IP20

2700°K - 4100°K Lumière neutre ou chaude - neutral or warm light

2018 - LALIQUÉ

Détails techniques et instructions de montage : cf fiche architecture. / Technical datas & mounting instructions: see architecture files.

Préciser la hauteur totale du lustre à la commande (minimum 700 mm). / Precise the total height of the chandelier when ordering (27.56 inches minimum)

ORGUE 2 RANGS, MM / 2 TIERS, MS



Incolore / Clear
Doré / Gilded



22,5 kg / 49.6 pounds

Incolore / Clear
Chromé / Chrome

FINITION / FINISHING

REFERENCE

EAN CODE



CRISTAL INCOLORE - CLEAR CRYSTAL
CHROMÉ - CHROME

EUROPE
10233100



CRISTAL INCOLORE - CLEAR CRYSTAL
CHROMÉ - CHROME

US
10233200



CRISTAL INCOLORE - CLEAR CRYSTAL
DORÉ - GILDED

EUROPE
10233300



CRISTAL INCOLORE - CLEAR CRYSTAL
DORÉ - GILDED

US
10233400



LED x 43 - 55 watts - 3900 lumens

CE IP20

4100°K - Lumière neutre - Neutral light

2012 - STUDIO ANDRÉE PUTMAN POUR LALIQUE

Détails techniques et instructions de montage : cf classeur architecture. / Technical datas & mounting instructions: see architecture files.

Préciser la hauteur totale du lustre à la commande. / Precise the total height of the chandelier when ordering.

Éclairage gradable avec télécommande. / Dimmable lighting with remote control.

LUSTRES - CHANDELIERS

ORGUE 2 RANGS / 2 TIERS



Ø 1135 mm / 44.69"

53 kg / 116.84 pounds

Incolore / Clear
Chromé / Chrome



Drop mini : 750 mm / 29.53"

Incolore / Clear
Doré / Gilded

FINITION / FINISHING



CRISTAL INCOLORE - CLEAR CRYSTAL
CHROMÉ - CHROME

REFERENCE

EUROPE
10153200

EAN CODE



CRISTAL INCOLORE - CLEAR CRYSTAL
CHROMÉ - CHROME

US
10158900



CRISTAL INCOLORE - CLEAR CRYSTAL
DORÉ - GILDED

EUROPE
10159000



CRISTAL INCOLORE - CLEAR CRYSTAL
DORÉ - GILDED

US
10159100



2011 - STUDIO ANDRÉE PUTMAN POUR LALIQUE



LED x 119 - 200 watts - 10800 lumens

CE IP20

4100°K - Lumière neutre - Neutral light

Détails techniques et instructions de montage : cf fiche architecture. / Technical datas & mounting instructions: see architecture files.

Préciser la hauteur totale du lustre à la commande. / Precise the total height of the chandelier when ordering.

Éclairage gradable avec télécommande. / Dimmable lighting with remote control.

LUSTRES - CHANDELIERS

ORGUE 3 RANGS / 3 TIERS



Incolore / Clear
Doré / Gilded



45 kg / 99.21 pounds

Incolore / Clear
Chromé / Chrome

FINITION / FINISHING

REFERENCE

EAN CODE



CRISTAL INCOLORE - CLEAR CRYSTAL
CHROMÉ - CHROME

EUROPE
10153300



CRISTAL INCOLORE - CLEAR CRYSTAL
CHROMÉ - CHROME

US
10159200



CRISTAL INCOLORE - CLEAR CRYSTAL
DORÉ - GILDED

EUROPE
10159300



CRISTAL INCOLORE - CLEAR CRYSTAL
DORÉ - GILDED

US
10159400



2011 - STUDIO ANDRÉE PUTMAN POUR LALIQUE



LED x 93 - 200 watts - 8400 lumens

CE IP20

4100°K - Lumière neutre - Neutral light

Détails techniques et instructions de montage : cf fiche architecture. / Technical datas & mounting instructions: see architecture files.

Préciser la hauteur totale du lustre à la commande. / Precise the total height of the chandelier when ordering.

Éclairage gradable avec télécommande. / Dimmable lighting with remote control.

LUSTRES - CHANDELIERS

SERENE 6 PRISMES, CIRCULAIRE / 6 PRISMS, CIRCULAR



FINITION / FINISHING	REFERENCE	EAN CODE
DAHLIA  CRISTAL INCOLORE CLEAR CRYSTAL	10435800	0 90592 91573 8
FIGURINES  CRISTAL INCOLORE CLEAR CRYSTAL	10435700	0 90592 91574 5



Bronze / Bronze



Nickel (plaqué) / Nickel (plated)



Or (plaqué) / Gold (plated)

3 finitions de montage disponibles. Merci de préciser la finition souhaitée lors de la commande.
3 available mounting finishing. Please specify the desired finishing when ordering.



LED G4 x 6 - 9 watts - 540 lumens

CE IP30

2700°K - Lumière chaude - Warm light

Luminaire non gradable. / Non dimmable lighting.

2014 - WINDFALL & LALIQUE

Détails techniques et instructions de montage : cf fiche architecture. / Technical datas & mounting instructions: see architecture files.
Hauteur réglable. Pas de drop minimum. / Height adjustable. No minimum drop.

Compositions de cristal et finitions métal réalisables sur mesure. / Bespoke crystal and metal finishing customized choice available upon request.

LUSTRES - CHANDELIERS

SERENE

12 PRISMES, CIRCULAIRE / 12 PRISMS, CIRCULAR



FINITION / FINISHING

REFERENCE

EAN CODE

DAHLIA



CRISTAL INCOLORE
CLEAR CRYSTAL

10432400



FIGURINES



CRISTAL INCOLORE
CLEAR CRYSTAL

10432500



Bronze / Bronze



Nickel (plaqué) / Nickel (plated)



Or (plaqué) / Gold (plated)

3 finitions de montage disponibles. Merci de préciser la finition souhaitée lors de la commande.
3 available mounting finishing. Please specify the desired finishing when ordering.



LED G4 x 12 - 18 watts - 1080 lumens



IP30

2700°K - Lumière chaude - Warm light

Luminaire non gradable. / Non dimmable lighting.

2014 - WINDFALL & LALIQUE

Détails techniques et instructions de montage : cf fiche architecture. / Technical datas & mounting instructions: see architecture files.

Hauteur réglable. Pas de drop minimum. / Height adjustable. No minimum drop.

Compositions de cristal et finitions métal réalisables sur mesure. / Bespoke crystal and metal finishing customized choice available upon request.

LUSTRES - CHANDELIERS

SERENE

18 PRISMES, CIRCULAIRE / 18 PRISMS, CIRCULAR

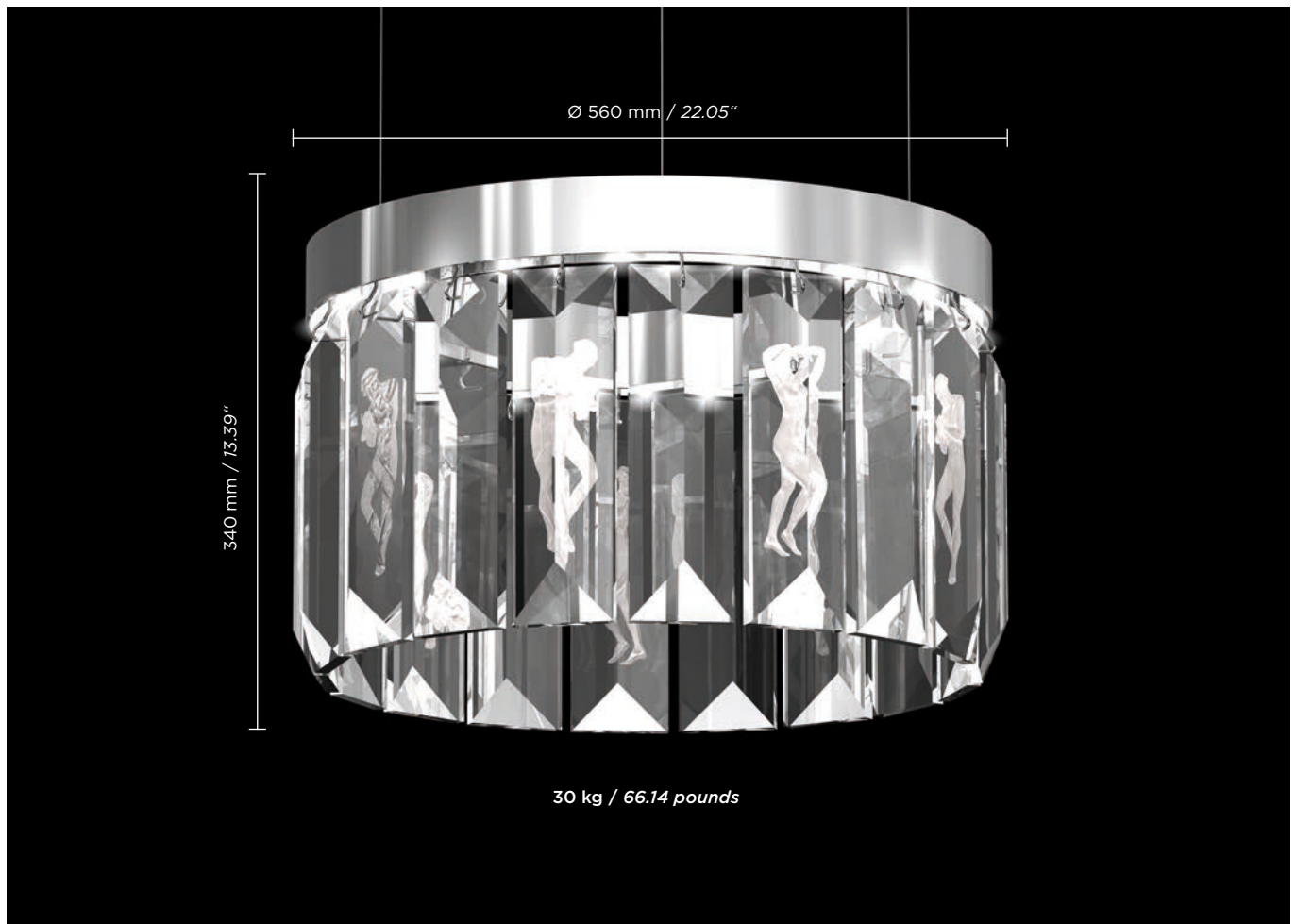

FINITION / FINISHING

REFERENCE

EAN CODE

DAHLIA



CRISTAL INCOLORE
CLEAR CRYSTAL

10436100



FIGURINES



CRISTAL INCOLORE
CLEAR CRYSTAL

10432600



Bronze / Bronze



Nickel (plaqué) / Nickel (plated)



Or (plaqué) / Gold (plated)

3 finitions de montage disponibles. Merci de préciser la finition souhaitée lors de la commande.
3 available mounting finishing. Please specify the desired finishing when ordering.



LED G4 x 18 - 27 watts - 1620 lumens

CE IP30

2700°K - Lumière chaude - Warm light

Luminaire non gradable. / Non dimmable lighting.

2014 - WINDFALL & LALIQUE

Détails techniques et instructions de montage : cf fiche architecture. / Technical datas & mounting instructions: see architecture files.

Hauteur réglable. Pas de drop minimum. / Height adjustable. No minimum drop.

Compositions de cristal et finitions métal réalisables sur mesure. / Bespoke crystal and metal finishing customized choice available upon request.

LUSTRES - CHANDELIERS

SERENE

24 PRISMES, CIRCULAIRE / 24 PRISMS, CIRCULAR

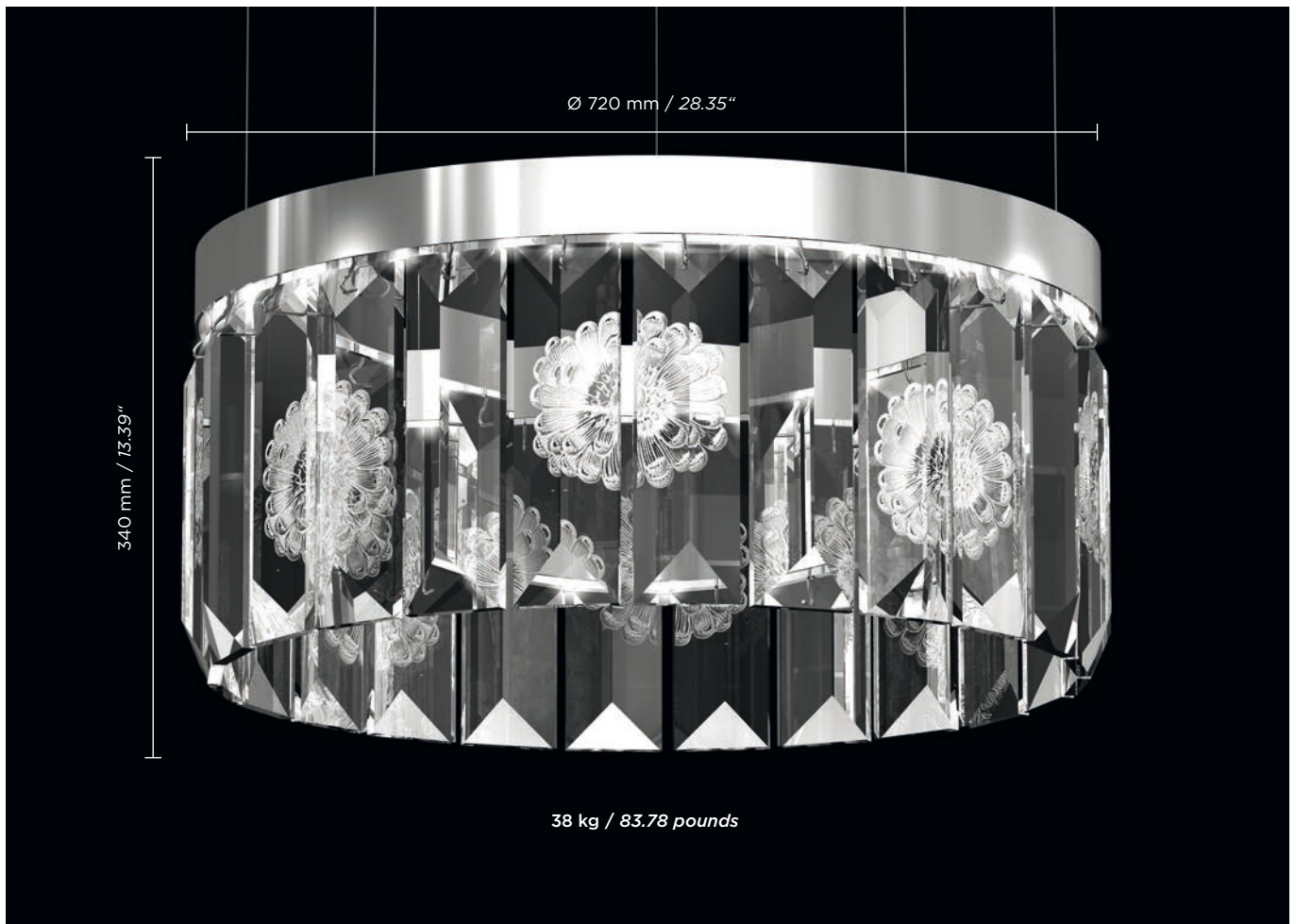

FINITION / FINISHING	REFERENCE	EAN CODE
DAHLIA  CRISTAL INCOLORE CLEAR CRYSTAL	10436300	 0 90592 91568 4
FIGURINES  CRISTAL INCOLORE CLEAR CRYSTAL	10436200	 0 90592 91569 1

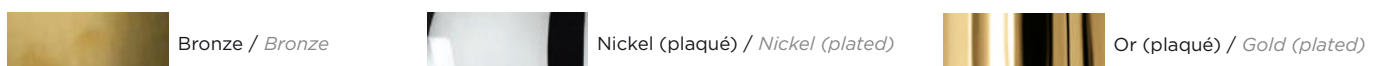

3 finitions de montage disponibles. Merci de préciser la finition souhaitée lors de la commande.
3 available mounting finishing. Please specify the desired finishing when ordering.



LED G4 x 24 - 36 watts - 2160 lumens

CE IP30 2700°K - Lumière chaude - Warm light

Luminaire non gradable. / Non dimmable lighting.

2014 - WINDFALL & LALIQUE

Détails techniques et instructions de montage : cf fiche architecture. / Technical datas & mounting instructions: see architecture files.
Hauteur réglable. Pas de drop minimum. / Height adjustable. No minimum drop.



Compositions de cristal et finitions métal réalisables sur mesure. / Bespoke crystal and metal finishing customized choice available upon request.

LUSTRES - CHANDELIERS

SERENE

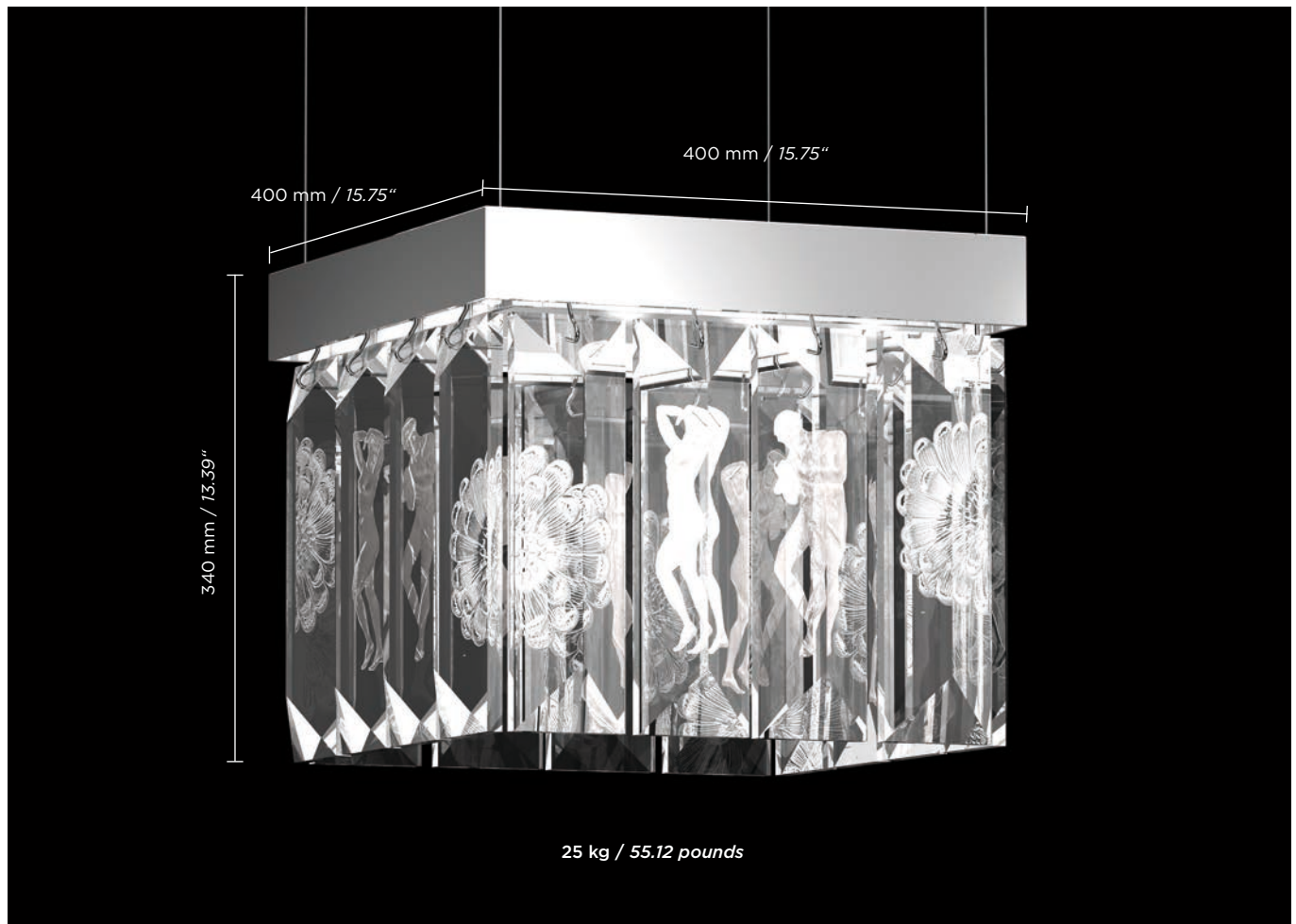
16 PRISMES, CARRÉ / 16 PRISMS, SQUARE



FINITION / FINISHING	REFERENCE	EAN CODE
FIGURINES ET DAHLIA  CRISTAL INCOLORE CLEAR CRYSTAL	10432900	0 90592 91604 9
DAHLIA  CRISTAL INCOLORE CLEAR CRYSTAL	10436000	0 90592 91571 4
FIGURINES  CRISTAL INCOLORE CLEAR CRYSTAL	10435900	0 90592 91572 1

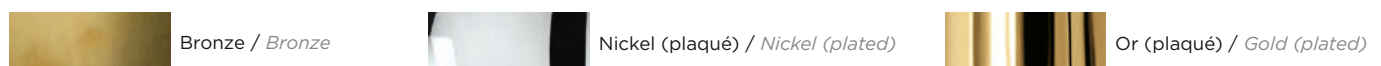

3 finitions de montage disponibles. Merci de préciser la finition souhaitée lors de la commande.
3 available mounting finishing. Please specify the desired finishing when ordering.





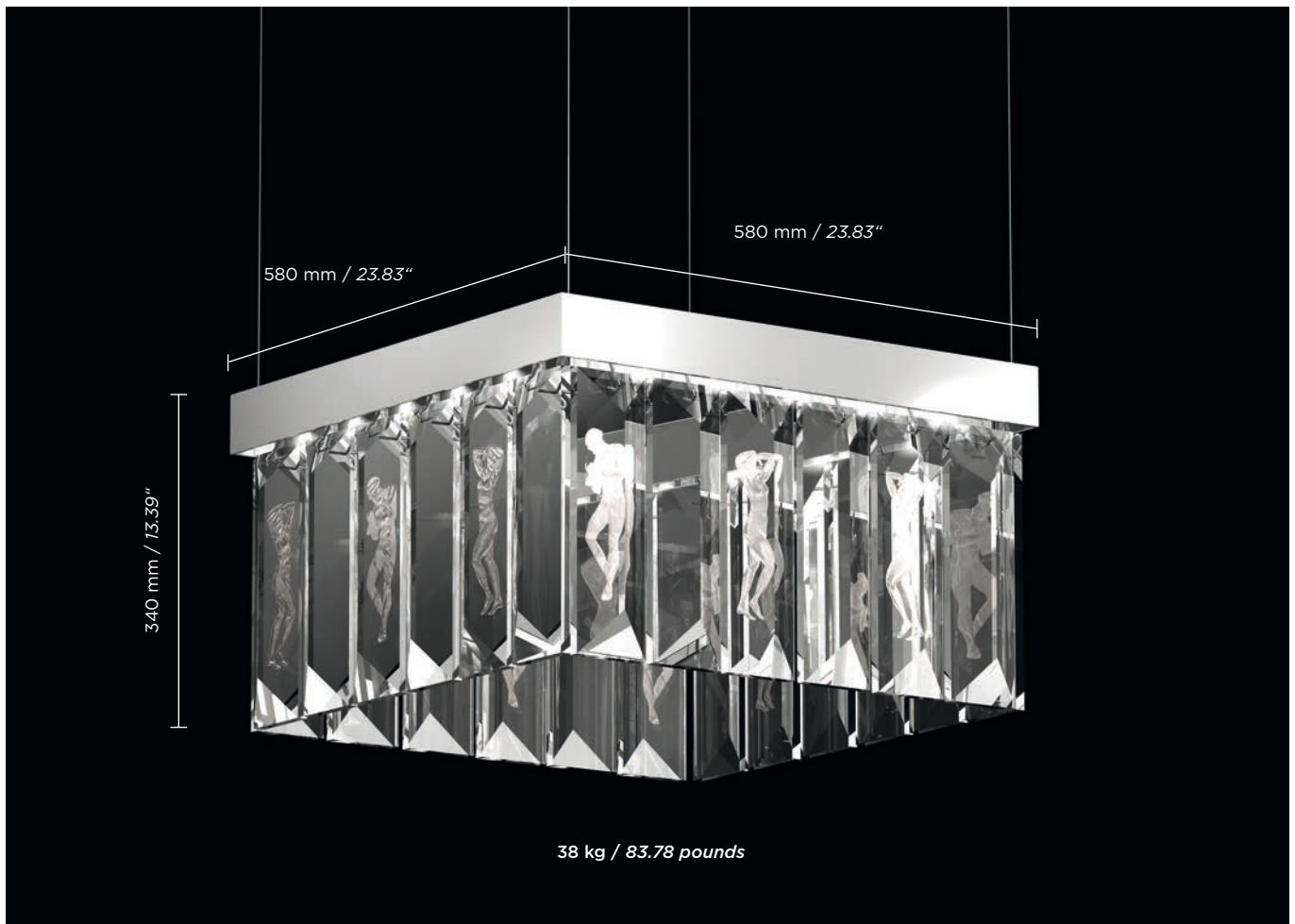

 LED G4 x 12 - 18 watts - 1080 lumens **CE IP30** 2700°K - Lumière chaude - Warm light Luminaire non gradable. / Non dimmable lighting.

2014 - WINDFALL & LALIQUE

Détails techniques et instructions de montage : cf fiche architecture. / Technical datas & mounting instructions: see architecture files.
Hauteur réglable. Pas de drop minimum. / Height adjustable. No minimum drop.

Compositions de cristal et finitions métal réalisables sur mesure. / Bespoke crystal and metal finishing customized choice available upon request.



FINITION / FINISHING	REFERENCE	EAN CODE
FIGURINES ET DAHLIA  CRISTAL INCOLORE CLEAR CRYSTAL	10436600	 0 90592 91565 3
DAHLIA  CRISTAL INCOLORE CLEAR CRYSTAL	10436500	 0 90592 91566 0
FIGURINES  CRISTAL INCOLORE CLEAR CRYSTAL	10436400	 0 90592 91567 7



Bronze / Bronze



Nickel (plaqué) / Nickel (plated)



Or (plaqué) / Gold (plated)

3 finitions de montage disponibles. Merci de préciser la finition souhaitée lors de la commande.
3 available mounting finishing. Please specify the desired finishing when ordering.



LED G4 x 12 - 30 watts - 1800 lumens

CE IP30 2700°K - Lumière chaude - Warm light

Luminaire non gradable. / Non dimmable lighting.

2014 - WINDFALL & LALIQUE

Détails techniques et instructions de montage : cf fiche architecture. / Technical datas & mounting instructions: see architecture files.
Hauteur réglable. Pas de drop minimum. / Height adjustable. No minimum drop.

Compositions de cristal et finitions métal réalisables sur mesure. / Bespoke crystal and metal finishing customized choice available upon request.

LUSTRES - CHANDELIERS

SERENE

26 PRISMES, RECTANGULAIRE / 26 PRISMS, RECTANGULAR

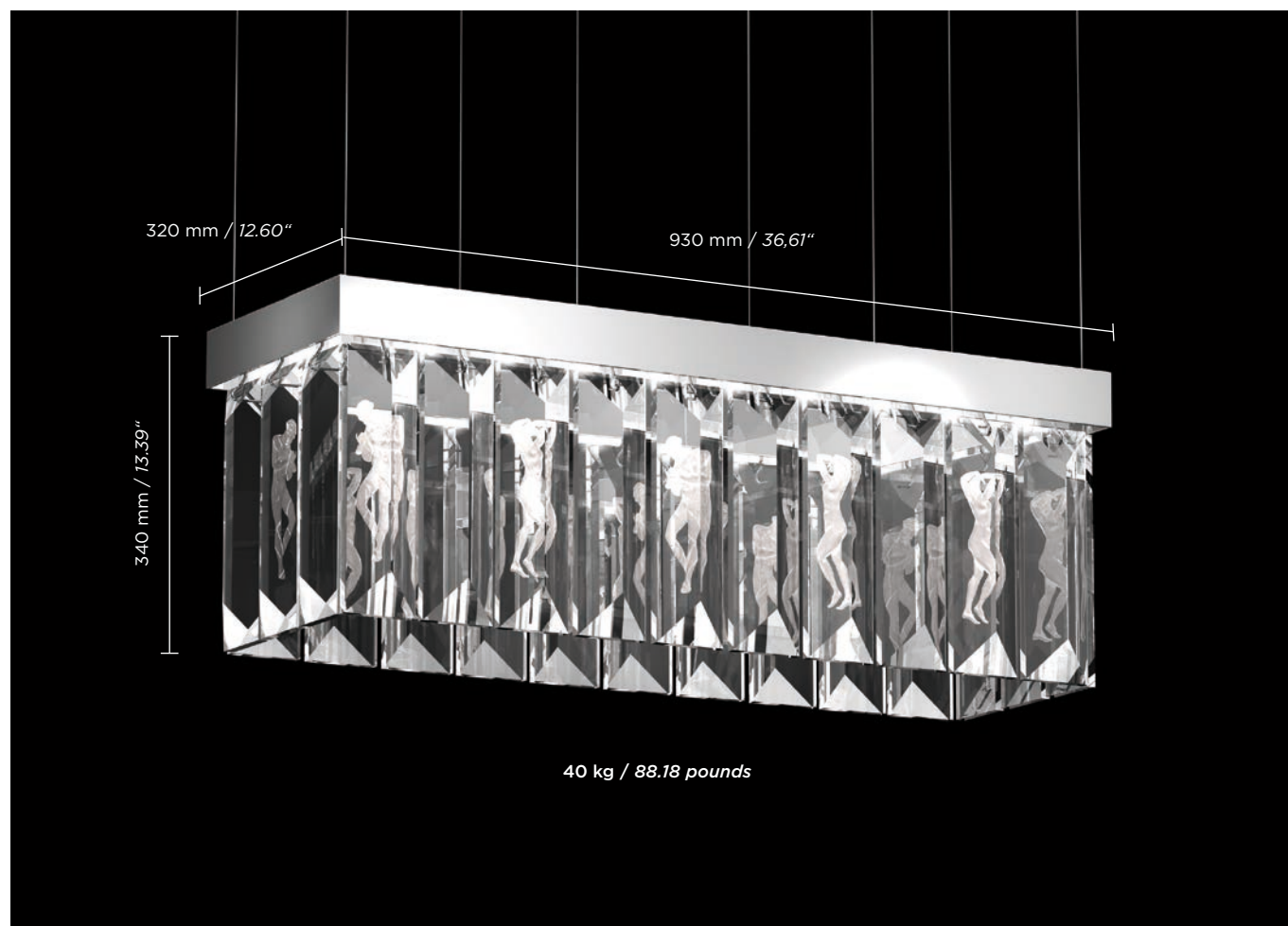

FINITION / FINISHING	REFERENCE	EAN CODE
DAHLIA  CRISTAL INCOLORE CLEAR CRYSTAL	10436700	0 90592 91564 6
FIGURINES  CRISTAL INCOLORE CLEAR CRYSTAL	10432700	0 90592 91606 3

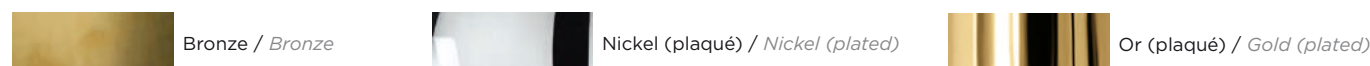

3 finitions de montage disponibles. Merci de préciser la finition souhaitée lors de la commande.
3 available mounting finishing. Please specify the desired finishing when ordering.

 LED G4 x 22 - 33 watts - 1980 lumens **CE IP30** 2700°K - Lumière chaude - Warm light Luminaire non gradable. / Non dimmable lighting.

2014 - WINDFALL & LALIQUE

Détails techniques et instructions de montage : cf fiche architecture. / Technical datas & mounting instructions: see architecture files.

Hauteur réglable. Pas de drop minimum. / Height adjustable. No minimum drop.

Compositions de cristal et finitions métal réalisables sur mesure. / Bespoke crystal and metal finishing customized choice available upon request.



LUSTRES - CHANDELIERS

SERENE

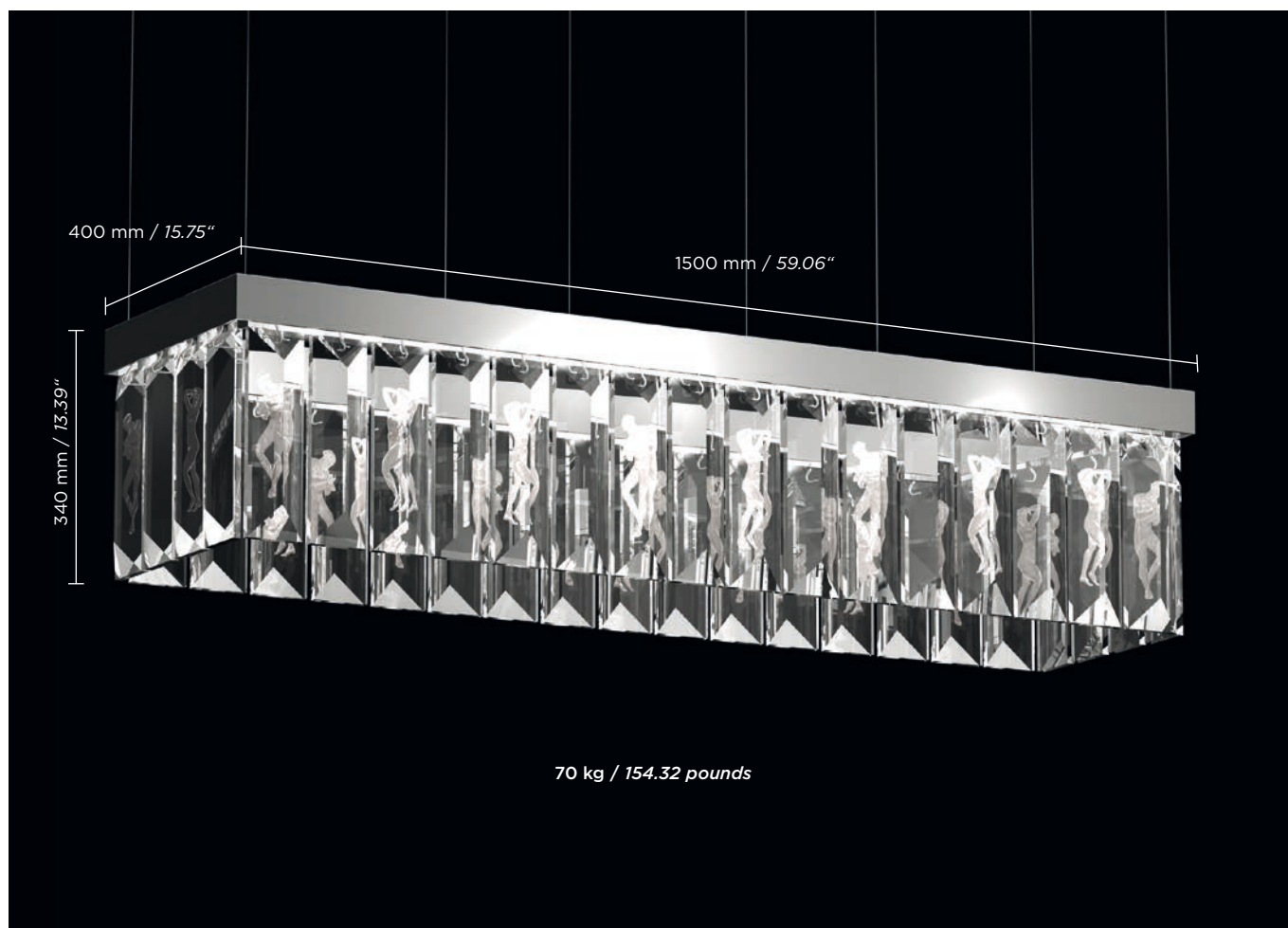
40 PRISMES, RECTANGULAIRE / 40 PRISMS, RECTANGULAR



70 kg / 154.32 pounds

FINITION / FINISHING	REFERENCE	EAN CODE
DAHLIA  CRISTAL INCOLORE CLEAR CRYSTAL	10436900	 0 90592 91562 2
FIGURINES  CRISTAL INCOLORE CLEAR CRYSTAL	10436800	 0 90592 91563 9



Bronze / Bronze



Nickel (plaqué) / Nickel (plated)



Or (plaqué) / Gold (plated)

3 finitions de montage disponibles. Merci de préciser la finition souhaitée lors de la commande.
 3 available mounting finishing. Please specify the desired finishing when ordering.



LED G4 x 36 - 54 watts - 3240 lumens



IP30

2700°K - Lumière chaude - Warm light

Luminaire non gradable. / Non dimmable lighting.

2014 - WINDFALL & LALIQUE

Détails techniques et instructions de montage : cf fiche architecture. / Technical datas & mounting instructions: see architecture files.

Hauteur réglable. Pas de drop minimum. / Height adjustable. No minimum drop.

Compositions de cristal et finitions métal réalisables sur mesure. / Bespoke crystal and metal finishing customized choice available upon request.

LUSTRES - CHANDELIERS

SÉVILLE

8 CRISTAUX, PM / 8 CRYSTALS, SS



Ø 340 mm / 13.39"

37 kg / 81.57 pounds

Incolore / Clear
Chromé / Chrome



Incolore / Clear
Doré / Gilded

FINITION / FINISHING



CRISTAL INCOLORE - CLEAR CRYSTAL
CHROMÉ - CHROME

REFERENCE

EUROPE
1010600

EAN CODE



CRISTAL INCOLORE - CLEAR CRYSTAL
CHROMÉ - CHROME

US
1010699



CRISTAL INCOLORE - CLEAR CRYSTAL
DORÉ - GILDED

EUROPE
1012000



CRISTAL INCOLORE - CLEAR CRYSTAL
DORÉ - GILDED

US
1012099



1947 - Marc Lalique



E27 x 1

CE IP20

2700°K - Lumière chaude - Warm light

Détails techniques et instructions de montage : cf fiche architecture. / Technical datas & mounting instructions: see architecture files.

Préciser la hauteur totale du lustre à la commande (minimum 580 mm). / Precise the total height of the chandelier when ordering (22.83 inches minimum).

PLAFONNIER - CEILING LIGHT

CORALLINE

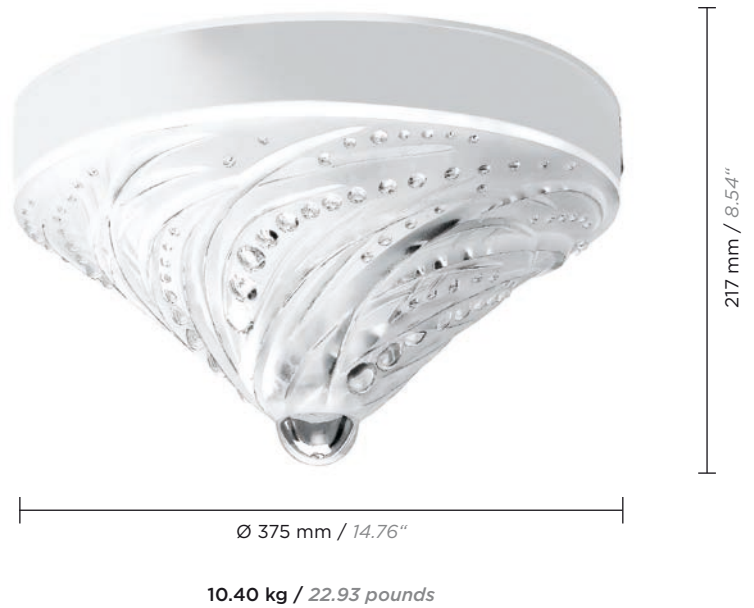

FINITION / FINISHING



CRISTAL INCOLORE - CLEAR CRYSTAL
CHROMÉ - CHROME



CRISTAL INCOLORE - CLEAR CRYSTAL
CHROMÉ - CHROME

REFERENCE

EUROPE
1012700

US
1012799

EAN CODE



E14 x 3

CE IP20 2700°K - Lumière chaude - Warm light

2004 - LALIQUE

Détails techniques et instructions de montage : cf fiche architecture. / Technical datas & mounting instructions: see architecture files.

SUSPENSIONS - CEILING LAMPS

COUTARD



4,20 kg / 9.26 pounds

FINITION / FINISHING



CRISTAL INCOLORE - CLEAR CRYSTAL
 CHROMÉ - CHROME

REFERENCE

EUROPE
 10552800

EAN CODE



CRISTAL INCOLORE - CLEAR CRYSTAL
 CHROMÉ - CHROME

US
 10552900



LED x 28 - 9 watts - 730 lumens

CE IP20

2700°K - Lumière chaude - Warm light à / to 4100°K - Lumière neutre - Neutral light

2017 - LALIQUE

Détails techniques et instructions de montage : cf fiche architecture. / Technical datas & mounting instructions: see architecture files.

SUSPENSIONS - CEILING LAMPS

GINKGO
PM / SS



Incolore / Clear
Doré / Gilded



Ø 370 mm / 14.57"

8,5 kg / 18.74 pounds

Incolore / Clear
Chromé / Chrome

800 mm / 31.50"

FINITION / FINISHING



CRISTAL INCOLORE - CLEAR CRYSTAL
NICKEL - NICKEL

REFERENCE

EUROPE
10579900

EAN CODE



CRISTAL INCOLORE - CLEAR CRYSTAL
NICKEL - NICKEL

US
10580000



CRISTAL INCOLORE - CLEAR CRYSTAL
DORÉ - GILDED

EUROPE
10580100



CRISTAL INCOLORE - CLEAR CRYSTAL
DORÉ - GILDED

US
10580200



E14 x 3 - 6 watts - 520 lumens

CE IP20

4100°K - Lumière neutre - Neutral light

2016 - LALIQUE & DELISLE

Détails techniques et instructions de montage : cf fiche architecture. / Technical datas & mounting instructions: see architecture files.

SUSPENSIONS - CEILING LAMPS

GINKGO GM / LS



FINITION / FINISHING

REFERENCE

EAN CODE

	CRISTAL INCOLORE - CLEAR CRYSTAL NICKEL - NICKEL	EUROPE 10580300	
	CRISTAL INCOLORE - CLEAR CRYSTAL NICKEL - NICKEL	US 10580400	
	CRISTAL INCOLORE - CLEAR CRYSTAL DORÉ - GILDED	EUROPE 10580500	
	CRISTAL INCOLORE - CLEAR CRYSTAL DORÉ - GILDED	US 10580600	



E14 x 13 - 6 watts - 520 lumens

CE IP20

4000°K - Lumière neutre - Neutral light

2017 - LALIQUE & DELISLE





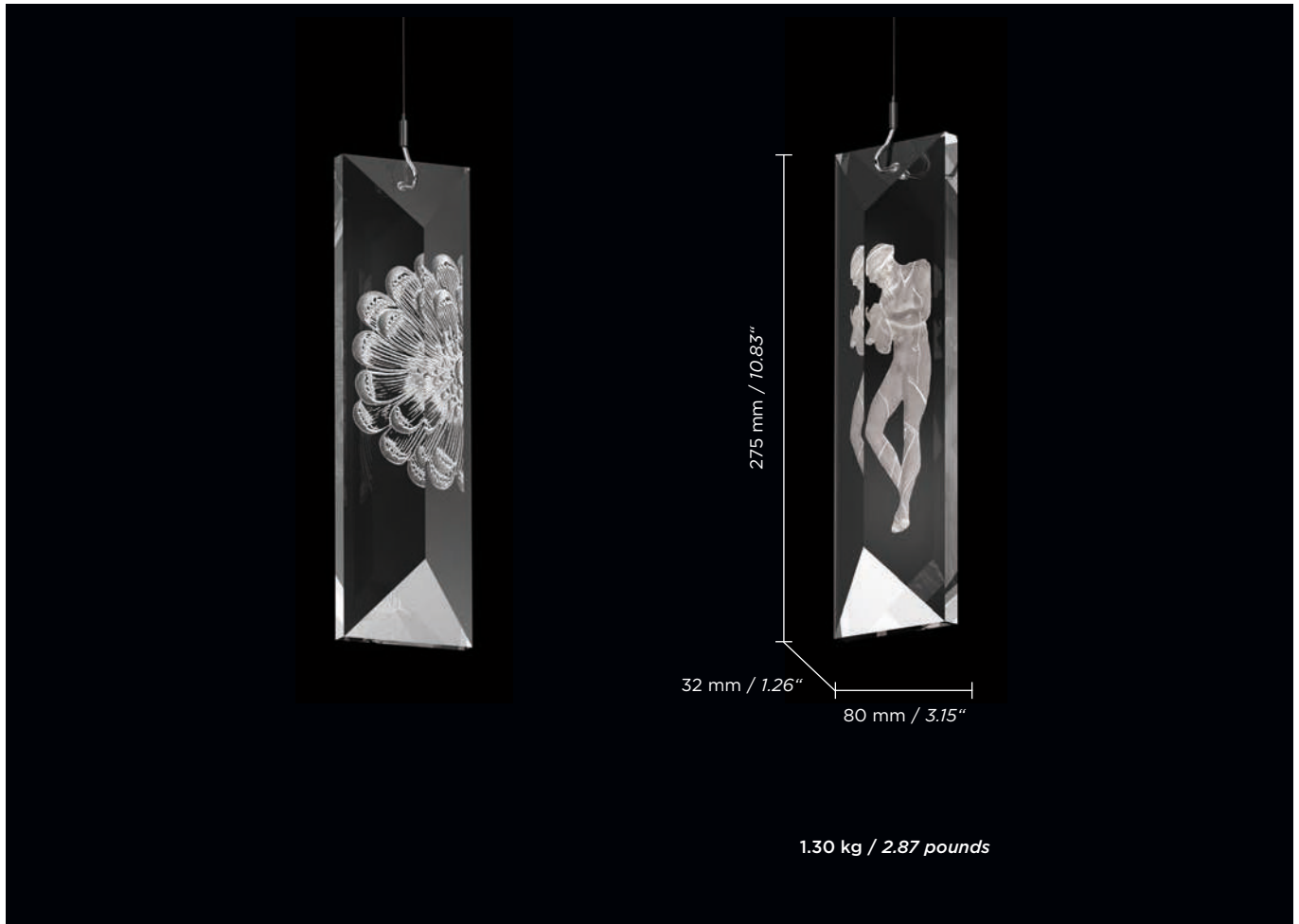

Détails techniques et instructions de montage : cf fiche architecture. / Technical datas & mounting instructions: see architecture files.

SUSPENSIONS - CEILING LAMPS

SERENE PRISME SIMPLE / SIMPLE PRISM



FINITION / FINISHING

FINITION / FINISHING	REFERENCE	EAN CODE
DAHLIA  CRISTAL INCOLORE CLEAR CRYSTAL	10433300	 0 90592 91600 1
FIGURINES  CRISTAL INCOLORE CLEAR CRYSTAL	10433200	 0 90592 91601 8
SANS MOTIFS WITHOUT MOTIV  CRISTAL INCOLORE CLEAR CRYSTAL	10433400	 0 90592 91599 8



Bronze / Bronze



Nickel (plaqué) / Nickel (plated)



Or (plaqué) / Gold (plated)

3 finitions de montage disponibles. Merci de préciser la finition souhaitée lors de la commande.
 3 available mounting finishing. Please specify the desired finishing when ordering.



LED (rétroéclairage depuis le plafond / downlight from the ceiling)



Luminaire non gradable. / Non dimmable lighting.

2014 - WINDFALL & LALIQUE

Détails techniques et instructions de montage : cf fiche architecture. / Technical datas & mounting instructions: see architecture files.
 Hauteur réglable. Pas de drop minimum. / Height adjustable. No minimum drop.

Compositions de cristal et finitions métal réalisables sur mesure. / Bespoke crystal and metal finishing customized choice available upon request.

SUSPENSIONS - CEILING LAMPS

SERENE PRISME DOUBLE / DOUBLE PRISM

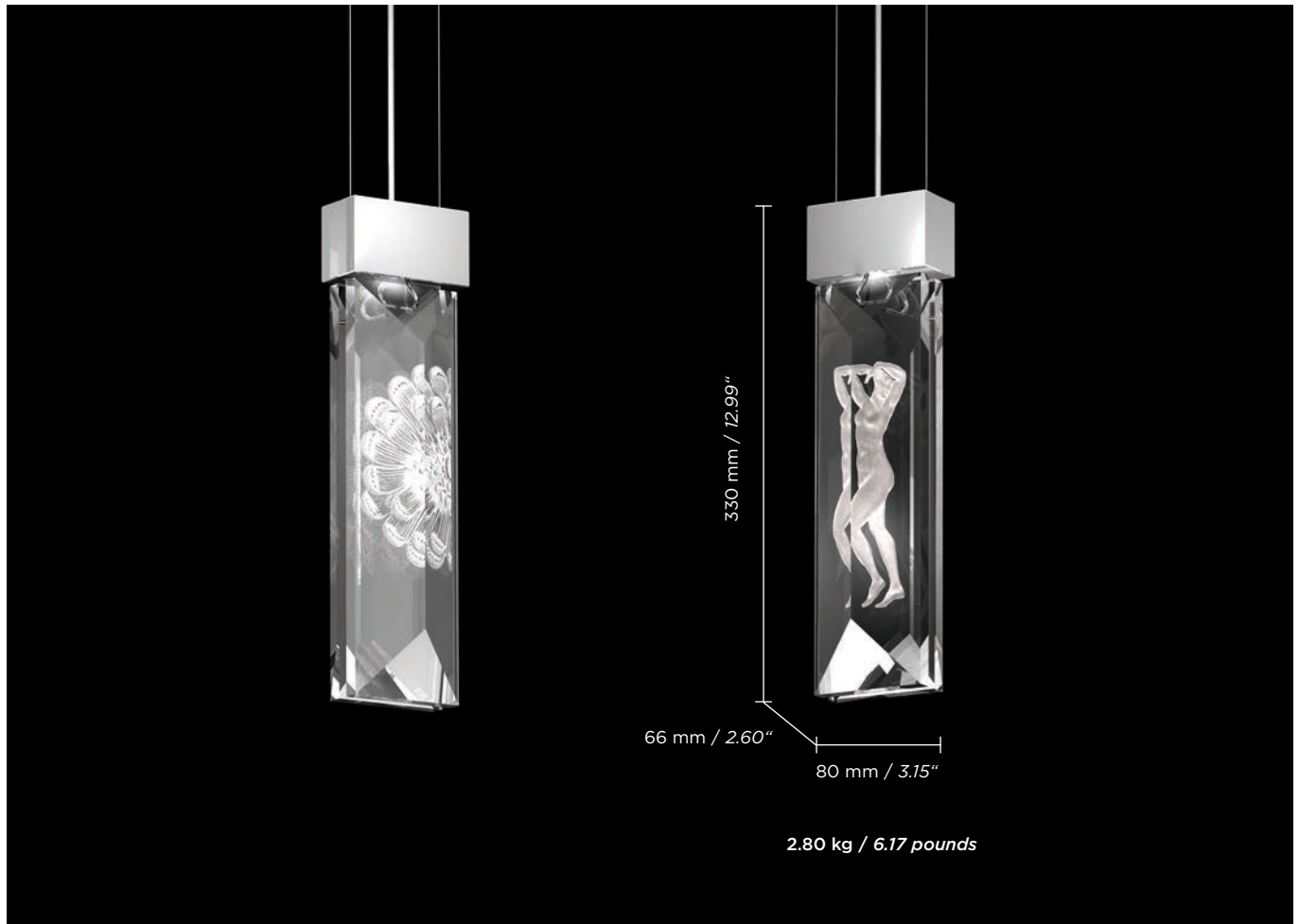

FINITION / FINISHING		REFERENCE	EAN CODE		
DAHLIA	 CRISTAL INCOLORE CLEAR CRYSTAL	10433100	 0 90592 91602 5		
FIGURINES	 CRISTAL INCOLORE CLEAR CRYSTAL	10433000	 0 90592 91603 2		
	Bronze / Bronze		Nickel (plaqué) / Nickel (plated)		Or (plaqué) / Gold (plated)

3 finitions de montage disponibles. Merci de préciser la finition souhaitée lors de la commande.
3 available mounting finishing. Please specify the desired finishing when ordering.



LED G4 x 1 - 1,5 watts - 90 lumens

CE IP30

2700°K - Lumière chaude - Warm light

Luminaire non gradable. / Non dimmable lighting.

2014 - WINDFALL & LALIQUE

Détails techniques et instructions de montage : cf fiche architecture. / Technical datas & mounting instructions: see architecture files.
Hauteur réglable. Pas de drop minimum. / Height adjustable. No minimum drop.

Compositions de cristal et finitions métal réalisables sur mesure. / Bespoke crystal and metal finishing customized choice available upon request.

SUSPENSIONS - CEILING LAMPS

SERENE

32 PRISMES SIMPLE / 32 SIMPLE PRISMS

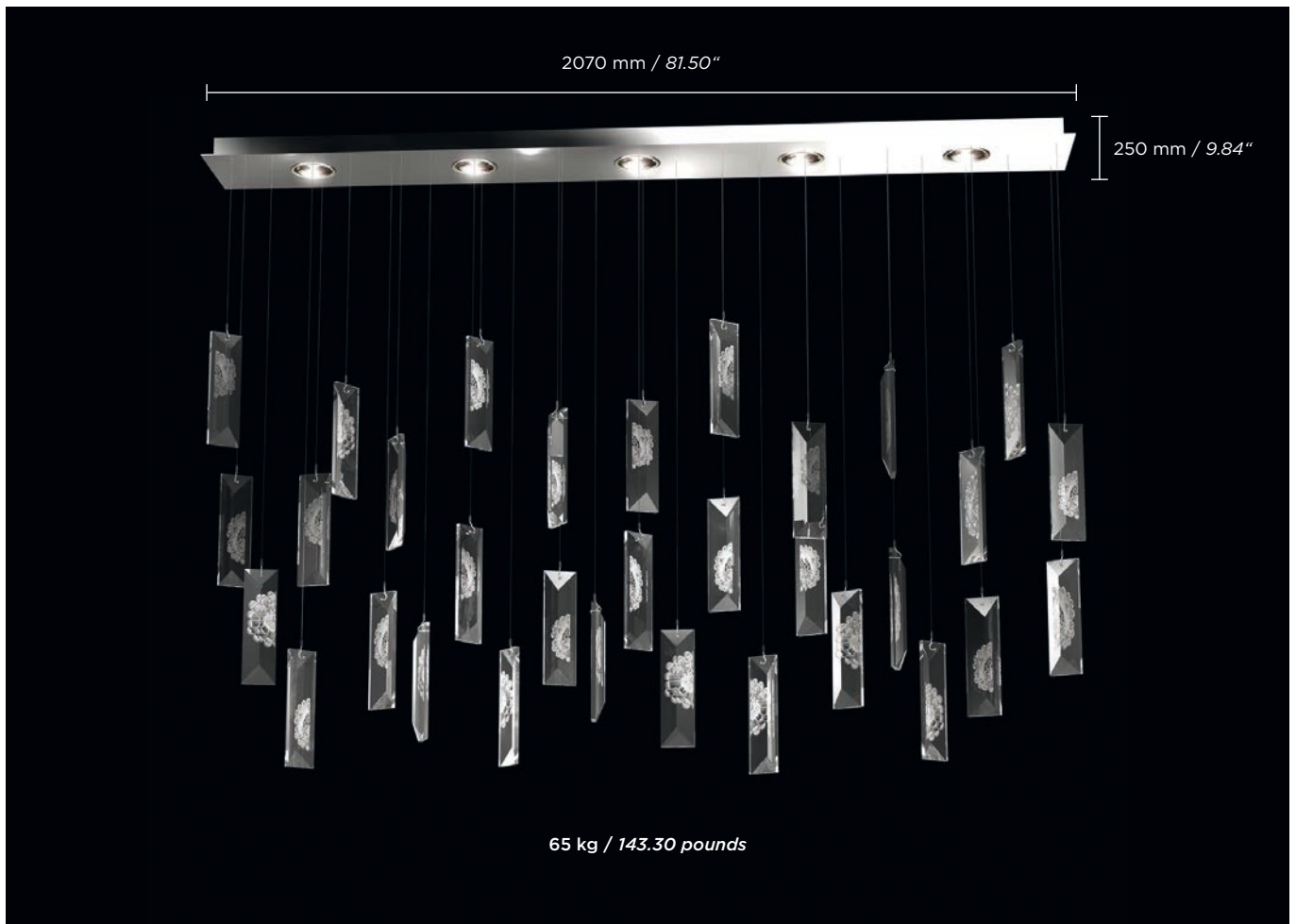

FINITION / FINISHING

REFERENCE

EAN CODE

DAHLIA



CRISTAL INCOLORE
CLEAR CRYSTAL

10450000



Bronze / Bronze



Nickel (plaqué) / Nickel (plated)



Or (plaqué) / Gold (plated)

3 finitions de montage disponibles. Merci de préciser la finition souhaitée lors de la commande.
3 available mounting finishing. Please specify the desired finishing when ordering.



LED (rétroéclairage depuis le plafond / downlight from the ceiling)

CE IP30

Luminaire non gradable. / Non dimmable lighting.

2014 - WINDFALL & LALIQUE

Détails techniques et instructions de montage : cf fiche architecture. / Technical datas & mounting instructions: see architecture files.
Hauteur réglable. Pas de drop minimum. / Height adjustable. No minimum drop.

Compositions de cristal et finitions métal réalisables sur mesure. / Bespoke crystal and metal finishing customized choice available upon request.

SUSPENSIONS - CEILING LAMPS

VIBRATION



FINITION / FINISHING



CRISTAL INCOLORE - CLEAR CRYSTAL
CHROMÉ - CHROME

REFERENCE

EUROPE
1158200

EAN CODE



CRISTAL INCOLORE - CLEAR CRYSTAL
CHROMÉ - CHROME

US
1158299



E14 x 1

CE IP20

2700°K - Lumière chaude - Warm light

2006 - LALIQUE

Longueur maximum : 2000 mm. / Height maximum: 78.74 inches.

Détails techniques et instructions de montage : cf fiche architecture. / Technical datas & mounting instructions: see architecture files.

TABLES & MEUBLES DE RANGEMENT
TABLES & CABINETS



BUREAU - *DESK*

COUTARD

ÉDITION NUMÉROTÉE / *NUMBERED EDITION*



FINITION / *FINISHING*

REFERENCE

EAN CODE



CRISTAL INCOLORE - *CLEAR CRYSTAL*
CUIR - *LEATHER*
MACASSAR - *MACASSAR*

10643300



CRISTAL INCOLORE - *CLEAR CRYSTAL*
CUIR - *LEATHER*
NICKEL - *NICKEL*

10643400



2018 - PIERRE-YVES ROCHON POUR LALIQUE

COMMODE - *DRAWER UNIT*

VIBRATION

ÉDITION NUMÉROTÉE / *NUMBERED EDITION*



220 kg / 485.02 pounds

FINITION / *FINISHING*

REFERENCE

EAN CODE



CRISTAL LUSTRÉ OR - *GOLD LUSTER CRYSTAL*
BRONZE - *BRONZE*
MARBRE NOIR - *BLACK MARBLE*

10637600



2017 - PIERRE-YVES ROCHON POUR LALIQUE

CONSOLES - CONSOLES

CACTUS DEMI-LUNE / HALF-MOON

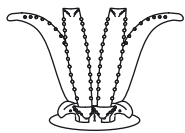

CONSOLE SANS DALLE

Hauteur x Largeur x Profondeur - Poids :
695 x 1140 x 600 mm - 90 kg

CONSOLE WITHOUT TABLE TOP





Height x Width x Depth - Weight:
27.36" x 44.88" x 23.62" - 253.53 pounds

FINITION / FINISHING

		REFERENCE	EAN CODE
	CRISTAL INCOLORE CLEAR CRYSTAL	1005600	 0 90592 10056 1
1987 - Marie-Claude Lalique			
	CRISTAL INCOLORE ET NOIR CLEAR AND BLACK CRYSTAL	1005620	 0 90592 08196 9
	CRISTAL AMBRE AMBER CRYSTAL	1005630	 0 90592 08730 5
2007 - LALIQUE			

Détails techniques et instructions de montage : cf fiche architecture. / Technical datas & mounting instructions: see architecture files.

DALLES / TABLE TOPS

		REFERENCE	EAN CODE
	 L1300 x P650 mm - E15 mm - 25 kg L51.18" x W25.59" - T0.59" - 55.11 pounds	10588400	 0 90592 08441 0
	 L1300 x P650 mm - E15 mm - 25 kg L51.18" x W25.59" - T0.59" - 55.11 pounds	0105620	 0 90592 08494 6

CACTUS RECTANGULAIRE / *RECTANGULAR*

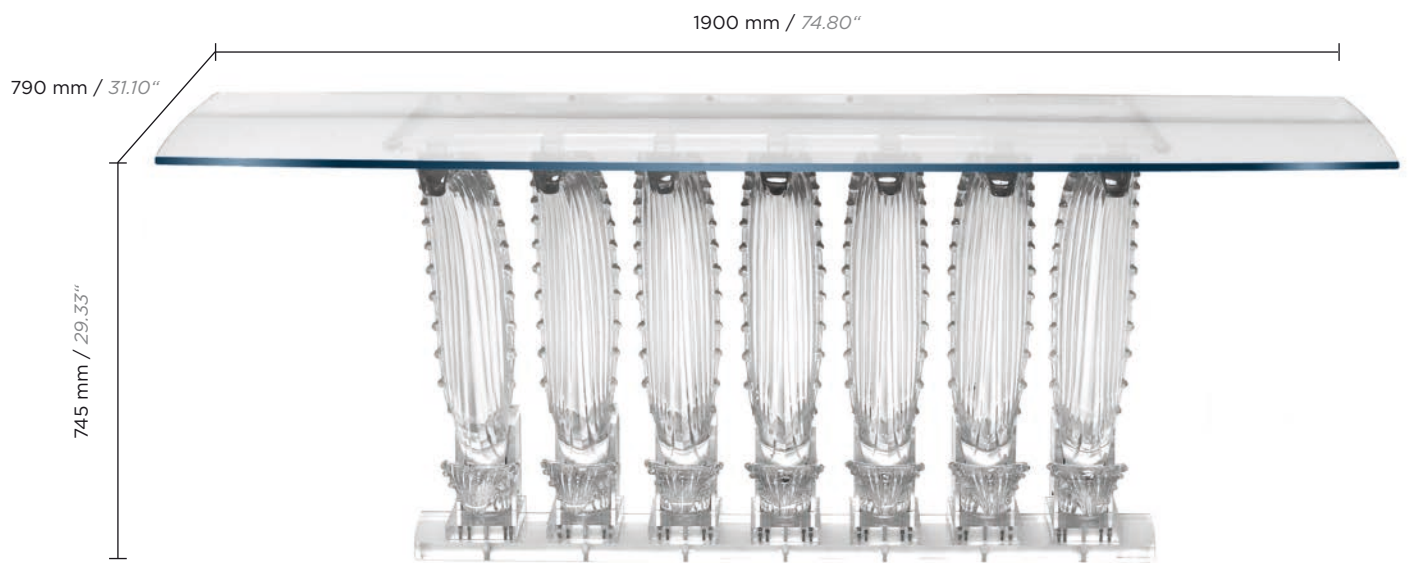

207 kg / 455.40 pounds

FINITION / *FINISHING*

REFERENCE

EAN CODE



CRISTAL INCOLORE
CLEAR CRYSTAL

10588600



2009 - LALIQUE

Détails techniques et instructions de montage : cf fiche architecture. / *Technical datas & mounting instructions: see architecture files.*
Console livrée avec dalle. / *Console delivered with table top.*

CONSOLES - CONSOLES

SÉVILLE



10,60 kg / 23.37 pounds



CONSOLE SANS DALLE

Hauteur x Largeur x Profondeur - Poids :
248 x 500 x 130 mm - 6,60 kg

CONSOLE WITHOUT TABLE TOP

Height x Width x Depth - Weight:
9.76" x 19.69" x 5.12" - 15.55 pounds

FINITION / FINISHING



CRISTAL INCOLORE
CLEAR CRYSTAL

REFERENCE

1005500

EAN CODE



1986 - Marie-Claude Lalique

Détails techniques et instructions de montage : cf fiche architecture. / Technical datas & mounting instructions: see architecture files.

Console livrée sans dalle. / Console delivered without table top.

DALLE / TABLE TOP



L500 x P300 mm - E12 mm - 4 kg
L19.69" x D11.81" - T0.47" - 8.82 pounds

REFERENCE

10588300

EAN CODE



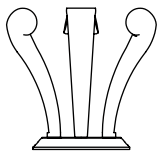

GUÉRIDON SANS DALLE

Hauteur x Diamètre - Poids :
660 x 700 mm - 76 kg

PEDESTAL TABLE WITHOUT TABLE TOP

Height x Diameter - Weight:
25.98" x 27.56" - 167.55 pounds

FINITION / FINISHING



CRISTAL INCOLORE
CLEAR CRYSTAL

REFERENCE

10060500

EAN CODE



2009 - LALIQUE

Détails techniques et instructions de montage : cf fiche architecture. / Technical datas & mounting instructions: see architecture files.
Console livrée sans dalle. / Console delivered without table top.

DALLES / TABLE TOPS

REFERENCE

EAN CODE

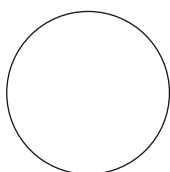

Ø 650 mm - E19 mm - 15,20 kg
Ø 25.59" - T0.75" - 33.51 pounds

10587100



Ø 900 mm - E19 mm - 24 kg
Ø 35.43" - T0.75" - 50.91 pounds

10587200



Ø 650 mm - E19 mm - 15,20 kg
Ø 25.59" - T0.75" - 33.51 pounds

10060800



2014 - LALIQUE

GUÉRIDONS - PEDESTAL TABLES

ROSES

ÉDITION NUMÉROTÉE / NUMBERED EDITION



123 kg / 271.17 pounds

FINITION / FINISHING

REFERENCE

EAN CODE



CRISTAL INCOLORE - CLEAR CRYSTAL
MACASSAR - MACASSAR

10643500



CRISTAL INCOLORE - CLEAR CRYSTAL
NICKEL - NICKEL

10643600



2018 - PIERRE-YVES ROCHON POUR LALIQUE

GUÉRIDONS - *PEDESTAL TABLES*

SOUDAN

ÉDITION NUMÉROTÉE / *NUMBERED EDITION*

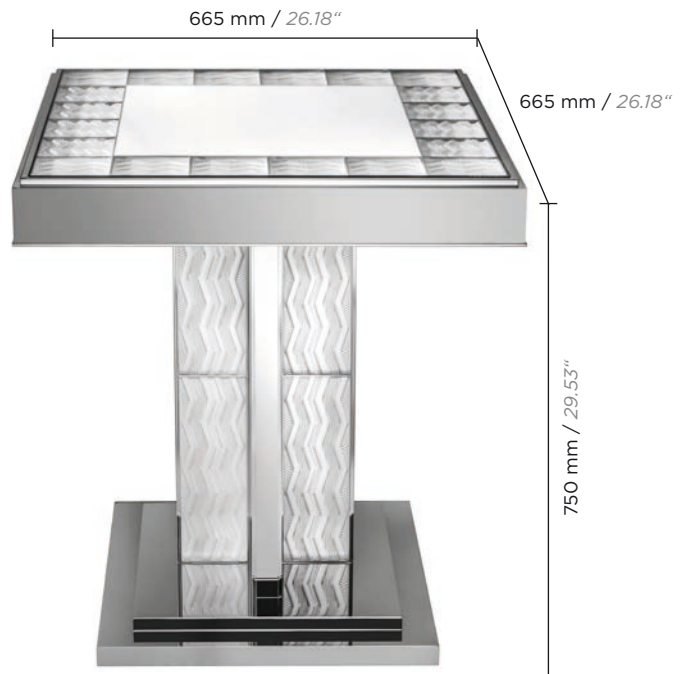

140 kg / 308.65 pounds

FINITION / *FINISHING*

REFERENCE

EAN CODE



CRISTAL INCOLORE - *CLEAR CRYSTAL*
MACASSAR - *MACASSAR*

10643700



CRISTAL INCOLORE - *CLEAR CRYSTAL*
NICKEL - *NICKEL*

10643800



2018 - PIERRE-YVES ROCHON POUR LALIQUE

GUÉRIDONS - PEDESTAL TABLES

VERSAILLES



FINITION / FINISHING

REFERENCE

EAN CODE



CRISTAL INCOLORE - CLEAR CRYSTAL
INOX BROSSÉ - BRUSHED STAINLESS STEEL

1025700



2006 - LALIQUE

Détails techniques et instructions de montage : cf fiche architecture. / Technical datas & mounting instructions: see architecture files.
Guéridon livré avec plateau. / Pedestal table delivered with tabletop.

TABLES - TABLES

CACTUS

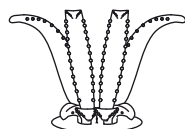
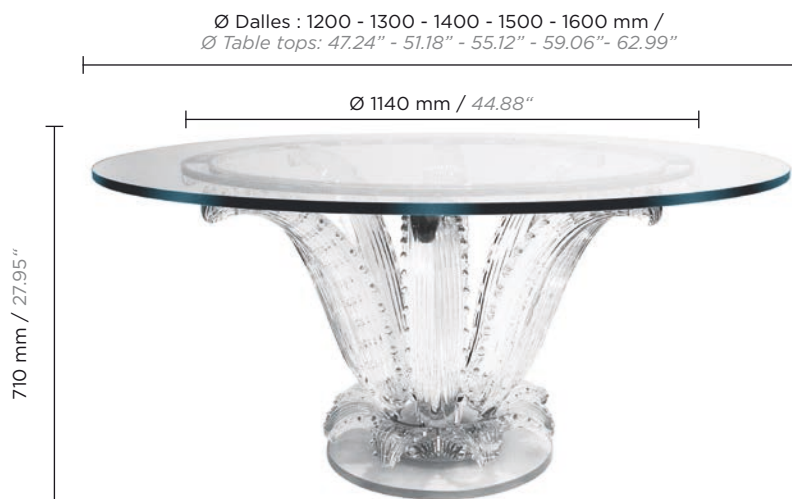





TABLE SANS DALLE

Hauteur x Diamètre - Poids :
691 x 1140 mm - 144 kg

TABLE WITHOUT TABLE TOP

Height x Diameter - Weight:
27.20" x 44.88" - 317.47 pounds

FINITION / FINISHING

FINITION / FINISHING	REFERENCE	EAN CODE
 1951 - Marc Lalique CRISTAL INCOLORE CLEAR CRYSTAL	1030200	0 90592 10302 9
 2006 - LALIQUE CRISTAL AMBRE AMBER CRYSTAL	1030220	0 90592 07819 8
 2007 - LALIQUE CRISTAL INCOLORE ET NOIR CLEAR AND BLACK CRYSTAL	1030230	0 90592 08195 2
 2019 - LALIQUE CRISTAL VERT GREEN CRYSTAL	10673600	0 90592 88966 4

Détails techniques et instructions de montage : cf fiche architecture. / Technical datas & mounting instructions: see architecture files.
 Table livrée sans dalle. / Table delivered without table top.

DALLES / TABLE TOPS

DALLES / TABLE TOPS	REFERENCE	EAN CODE
 4 PERSONNES MAXIMUM - 4 PERSONS MAXIMUM Ø 1200 mm - E19 mm - 43 kg Ø 47.24" - T0.75" - 94.8 pounds	10587300	0 90592 89952 6
6 PERSONNES MAXIMUM - 6 PERSONS MAXIMUM Ø 1300 mm - E19 mm - 50 kg Ø 51.18" - T0.75" - 110.23 pounds	10587400	0 90592 89951 9
6 PERSONNES MAXIMUM - 6 PERSONS MAXIMUM Ø 1400 mm - E19 mm - 74 kg Ø 55.12" - T0.75" - 163.14 pounds	10587500	0 90592 89950 2
6 PERSONNES MAXIMUM - 6 PERSONS MAXIMUM Ø 1500 mm - E19 mm - 84 kg Ø 59.06" - T0.75" - 185.19 pounds	10587600	0 90592 89949 6
8 PERSONNES MAXIMUM - 8 PERSONS MAXIMUM Ø 1600 mm - E19 mm - 96 kg Ø 62.99" - T0.75" - 211.64 pounds	10587700	0 90592 89948 9

TABLES - TABLES

CACTUS DOUBLE / DOUBLE



536 kg / 1181.68 pounds

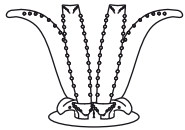

TABLE SANS DALLE

Hauteur x Diamètre - Poids :
691 x 1140 mm - 144 kg par pied

TABLE WITHOUT TABLE TOP

Height x Diameter - Weight:
27.20" x 44.88" - 317.47 pounds per table foot

FINITION / FINISHING

REFERENCE

EAN CODE



CRISTAL INCOLORE
CLEAR CRYSTAL

1030200



1951 - Marc Lalique



CRISTAL AMBRE
AMBER CRYSTAL

1030220



2006 - LALIQUE



CRISTAL INCOLORE ET NOIR
CLEAR AND BLACK CRYSTAL

1030230



2007 - LALIQUE

Détails techniques et instructions de montage : cf fiche architecture. / Technical datas & mounting instructions: see architecture files.

Table livrée sans dalle. / Table delivered without table top.

**POUR TOUTE COMMANDE D'UNE TABLE DOUBLE CACTUS, MERCI DE COMMANDER DEUX FOIS LA RÉFÉRENCE DU PIED SIMPLE CI-DESSUS.
FOR EVERY ORDER OF A DOUBLE CACTUS TABLE, PLEASE ORDER TWICE THE REFERENCE ABOVE.**

DALLES / TABLE TOPS

REFERENCE

EAN CODE



14 PERSONNES MAXIMUM - 14 PERSONS MAXIMUM
L3600 x l1600 mm - E19 mm - 248 kg
L141.73" x W62.99" - T0.75" - 546.75 pounds

10588200



TABLES - TABLES

CACTUS RECTANGULAIRE / RECTANGULAR

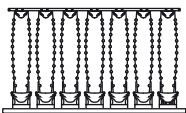

TABLE SANS DALLE

Hauteur x Longueur x Largeur - Poids :
745 x 1266 x 1126 mm - 275 kg

TABLE WITHOUT TABLE TOP

Height x Length x Width - Weight:
29.33" x 49.84" x 44.33" - 606.27 pounds

FINITION / FINISHING



CRISTAL INCOLORE
CLEAR CRYSTAL

REFERENCE

10068100

EAN CODE



2009 - LALIQUE

Détails techniques et instructions de montage : cf fiche architecture. / Technical datas & mounting instructions: see architecture files.

Table livrée sans dalle. / Table delivered without table top.

DALLES / TABLE TOPS



10 PERSONNES MAXIMUM - 10 PERSONS MAXIMUM

L1800 X l1600 mm - E19 mm - 162 kg
L70.87" x W62.99" - T0.75" - 357.15 pounds

10588000



12 PERSONNES MAXIMUM - 12 PERSONS MAXIMUM

L2400 x l1700 mm - E19 mm - 217 kg
L94.50" x W66.93" - T0.75" - 477.40 pounds

10588100



TABLES - TABLES

CHÊNE

Ø Dalles : 1200 - 1300 - 1400 mm / Ø Table tops: 47.24" - 51.18" - 55.12"



264 kg / 582.02 pounds

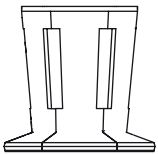

TABLE SANS DALLE

Hauteur x Diamètre - Poids :
751 x 780 mm - 190 kg

TABLE WITHOUT TABLE TOP
Height x Diameter - Weight:
29.57" x 30.71" - 418.88 pounds

FINITION / FINISHING



CRISTAL INCOLORE
CLEAR CRYSTAL

REFERENCE

1031100

EAN CODE



1951 - Marc Lalique

Détails techniques et instructions de montage : cf fiche architecture. / Technical datas & mounting instructions: see architecture files.

Table livrée sans dalle. / Table delivered without table top.

DALLES / TABLE TOPS

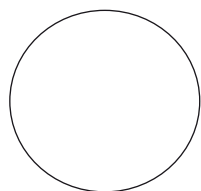

4 PERSONNES MAXIMUM - 4 PERSONS MAXIMUM

Ø 1200 mm - E19 mm - 43 kg
Ø 47.24" - T0.75" - 94.8 pounds

10587300



6 PERSONNES MAXIMUM - 6 PERSONS MAXIMUM

Ø 1300 mm - E19 mm - 50 kg
Ø 51.18" - T0.75" - 110.23 pounds

10587400



6 PERSONNES MAXIMUM - 6 PERSONS MAXIMUM

Ø 1400 mm - E19 mm - 74 kg
Ø 55.12" - T0.75" - 163.14 pounds

10587500



TABLES - TABLES

COUTARD
 RECTANGULAIRE / *RECTANGULAR*
 CARRÉE / *SQUARE*
 ÉDITION NUMÉROTÉE / *NUMBERED EDITION*

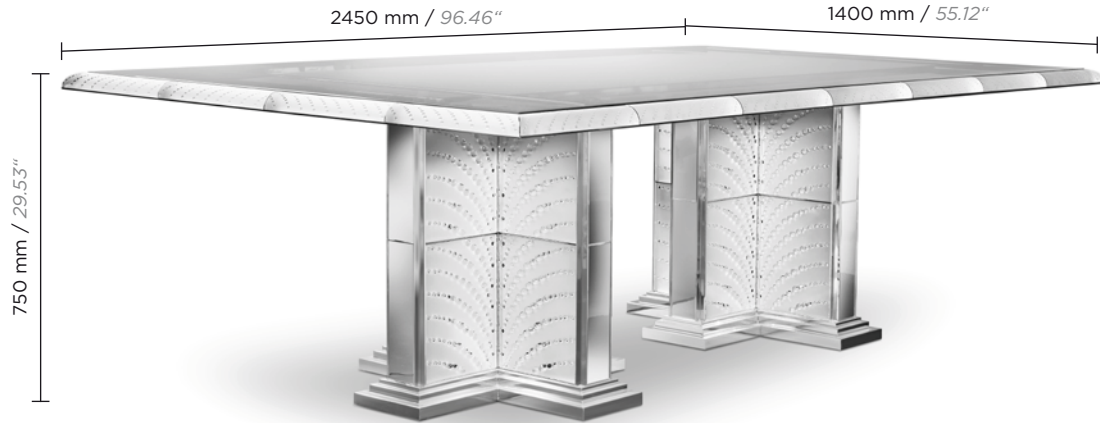

425 kg / 936.96 pounds

Rectangulaire / Rectangular

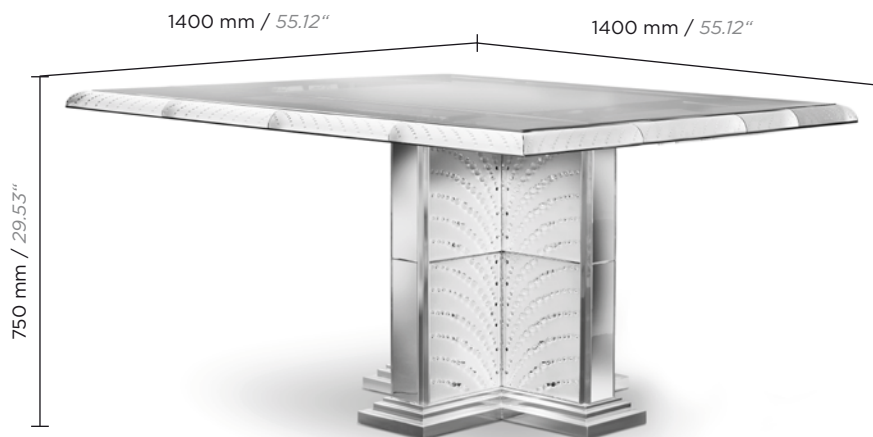

250 kg / 520.30 pounds

Carrée / Square

FINITION / *FINISHING*

REFERENCE

EAN CODE



10 PERSONNES MAXIMUM - 10 PERSONS MAXIMUM
 CRISTAL INCOLORE - *CLEAR CRYSTAL*

10611100



Rectangulaire / Rectangular



4 PERSONNES MAXIMUM - 4 PERSONS MAXIMUM
 CRISTAL INCOLORE - *CLEAR CRYSTAL*

10611000



Carrée / Square



4 PERSONNES MAXIMUM - 4 PERSONS MAXIMUM
ÉCLAIRÉE - *LIGHTED*
 CRISTAL INCOLORE - *CLEAR CRYSTAL*

10631600



2017 - PIERRE-YVES ROCHON POUR LALIQUE

TABLES BASSES - COFFEE TABLES

PERLES D'EAU / WATER PEARLS

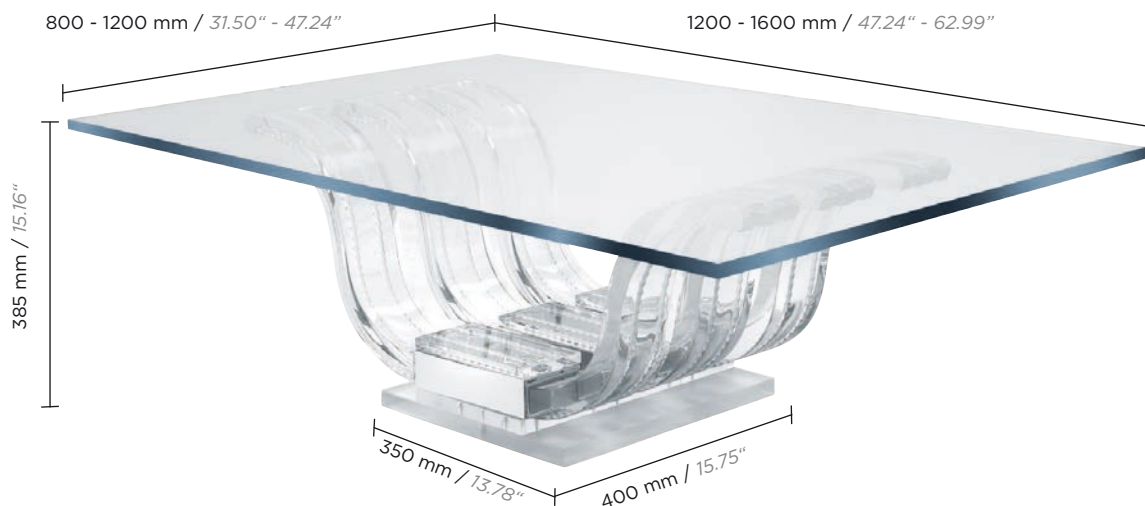

Table double / Double table



TABLE SANS DALLE

Hauteur x Longueur x Largeur - Poids :
370 x 915 x 400 mm - 50 kg

TABLE WITHOUT TABLE TOP

Height x Length x Width - Weight:
14.57" x 36.02" x 15.75" - 110.23 pounds

FINITION / FINISHING



CRISTAL INCOLORE
CLEAR CRYSTAL

REFERENCE

1030300

EAN CODE



1990 - Marie-Claude Lalique

Détails techniques et instructions de montage : cf fiche architecture. / Technical datas & mounting instructions: see architecture files.

Table livrée sans dalle. / Table delivered without table top.

PIED DE TABLE LIVRÉ À L'UNITÉ. COMMANDER DEUX PIEDS POUR UNE TABLE DOUBLE.

TABLE FOOT DELIVERED INDIVIDUALLY. TWO FOOT MUST BE ORDERED FOR A DOUBLE TABLE.

DALLES / TABLE TOPS

REFERENCE

EAN CODE



DALLE SIMPLE - SINGLE TABLE TOP

L1200 X l800 mm - E15 mm - 36 kg
L47.24" x W31.50" - T0.59" - 79.37 pounds

10587800



DALLE DOUBLE - DOUBLE TABLE TOP

L1600 x l1200 mm - E15 mm - 72 kg
L62.99" x W47.24" - T0.59" - 158.73 pounds

10587900



TABLES BASSES - COFFEE TABLES

VERSAILLES



104,80 kg / 231.04 pounds



PIED DE TABLE SANS DALLE

Hauteur x Longueur x Largeur - Poids :
380 x 230 x 230 mm - 12,70 kg par pied

TABLE FOOT WITHOUT TABLE TOP

Height x Length x Width - Weight:
14.95" x 9.06" x 9.06" - 20 pounds per table foot

FINITION / FINISHING

REFERENCE

EAN CODE



CRISTAL INCOLORE
CLEAR CRYSTAL

1031400



2006 - LALIQUE

Détails techniques et instructions de montage : cf fiche architecture. / Technical datas & mounting instructions: see architecture files.

Table livrée sans dalle. / Table delivered without table top.

POUR TOUTE COMMANDE D'UNE TABLE BASSE VERSAILLES, MERCI DE COMMANDER 4 FOIS LA RÉFÉRENCE DU PIED DE TABLE 1031400.

FOR EVERY ORDER OF A VERSAILLES COFFEE TABLE, PLEASE ORDER 4 TIMES THE REFERENCE OF THE TABLE FOOT: 1031400.

DALLES / TABLE TOPS

REFERENCE

EAN CODE

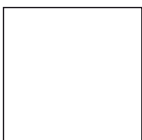

L1200 x l1200 mm - E15 mm - 54 kg
L47.24" x W47.24" - T0.59" - 119.05 pounds

10588500

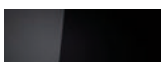

L1200 x l1200 mm - E15 mm - 54 kg
L47.24" x l47.24" - T0.59" - 119.05 pounds

0131200



VANITY - VANITY

CAUSEUSES

ÉDITION NUMÉROTÉE / *NUMBERED EDITION*

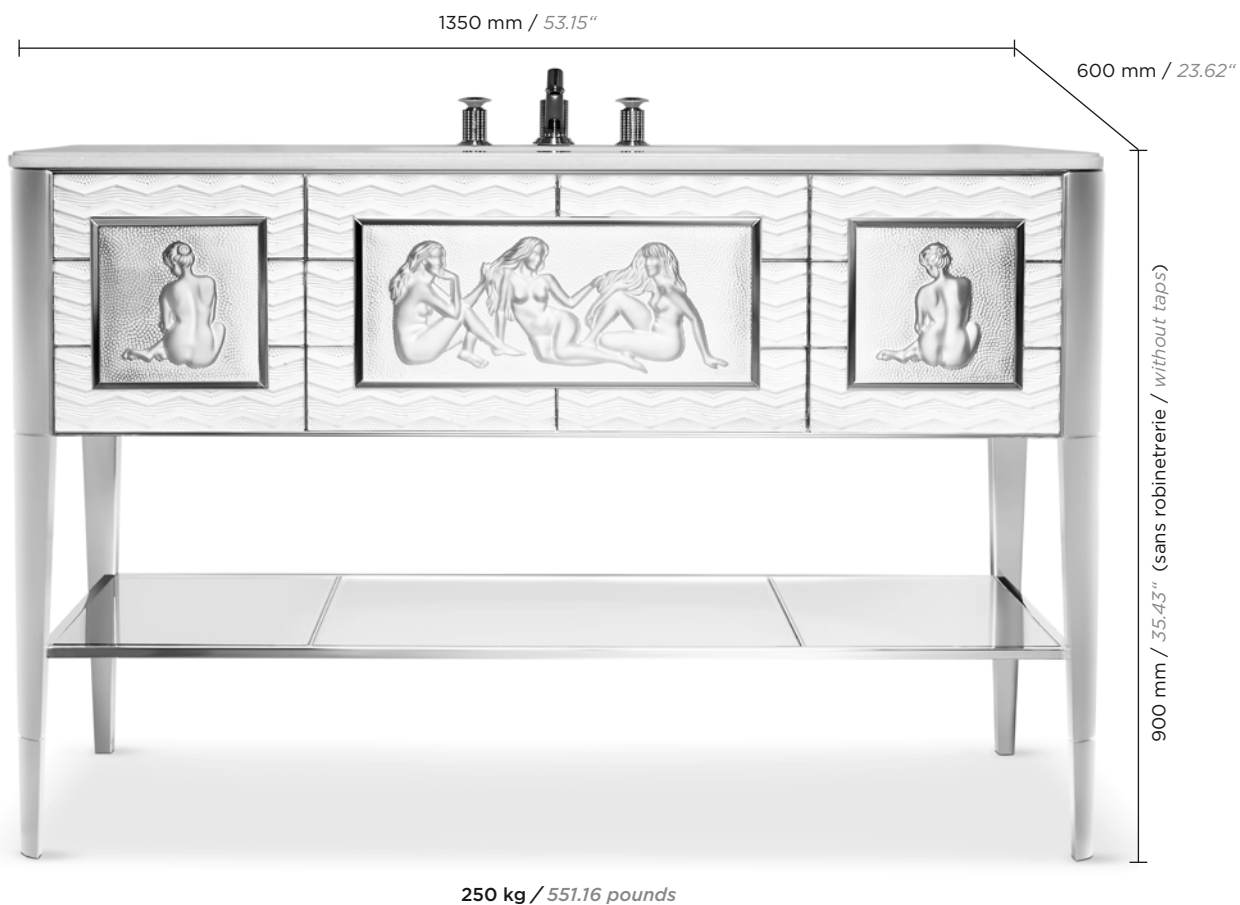

FINITION / *FINISHING*

REFERENCE

EAN CODE

AVEC TIROIRS
WITH DRAWERS



CRISTAL INCOLORE - *CLEAR CRYSTAL*
NICKEL BRILLANT - *BRIGHT NICKEL*
MARBRE BLANC - *WHITE MARBLE*

10637700



2017 - PIERRE-YVES ROCHON POUR LALIQUE



ASSISES - SEATINGS

CHAISES CONTEMPORAINES - *CONTEMPORARY CHAIRS*

COUTARD

AVEC CRISTAL ENCHÂSSÉ / *WITH ADORNED CRYSTAL*

ÉDITION NUMÉROTÉE / *NUMBERED EDITION*



16 kg / 35.27 pounds

Nickel / *Nickel*



Noyer teinté / *Tinted walnut*

FINITION / *FINISHING*

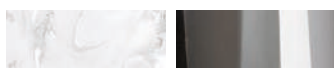

CRISTAL INCOLORE - *CLEAR CRYSTAL*
CUIR - *LEATHER*
NICKEL - *NICKEL*

REFERENCE

10644100

EAN CODE



CRISTAL INCOLORE - *CLEAR CRYSTAL*
CUIR - *LEATHER*
NOYER TEINTÉ - *TINTED WALNUT*

10644200



2018 - PIERRE-YVES ROCHON POUR LALIQUE

CHAISES CONTEMPORAINES - *CONTEMPORARY CHAIRS*

COUTARD

ÉDITION NUMÉROTÉE / *NUMBERED EDITION*



Incolore / *Clear*
Hêtre laqué bronze / *Bronze lacquered beech*

FINITION / *FINISHING*

REFERENCE

EAN CODE

		CRISTAL INCOLORE - <i>CLEAR CRYSTAL</i> CUIR - <i>LEATHER</i> HÊTRE LAQUÉ MÉTAL - <i>METAL LACQUERED BEECH</i>	10644300	 0 90592 89337 1
		CRISTAL INCOLORE - <i>CLEAR CRYSTAL</i> SOIE - <i>SILK</i> HÊTRE LAQUÉ BRONZE - <i>BRONZE LACQUERED BEECH</i>	10644400	 0 90592 89336 4
		CRISTAL INCOLORE - <i>CLEAR CRYSTAL</i> CUIR - <i>LEATHER</i> HÊTRE LAQUÉ NOIR - <i>BLACK LACQUERED BEECH</i>	10644500	 0 90592 89335 7

2018 - PIERRE-YVES ROCHON POUR LALIQUE

AUTRE MOBILIER - *OTHER FURNITURE*



LANGUEDOC



Ø 900 / 35.43"

20 kg / 44.09 pounds

ROND GM / ROUND LS



Ø 400 / 15.75"

2,80 kg / 6.17 pounds

ROND MM / ROUND MS



Ø 300 / 11.81"

2 kg / 4.41 pounds

ROND PM / ROUND SS

MIROIRS - MIRRORS

LANGUEDOC



Gabarit de cette composition disponible sur demande auprès de l'atelier de montage.
 Template of this arrangement available on request from the assembly workshop.

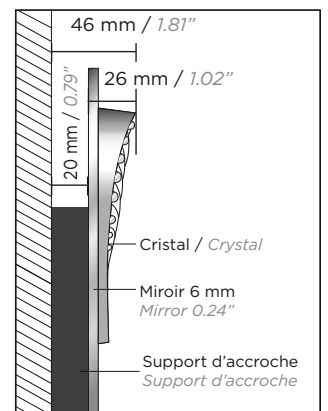

FINITION / FINISHING

REFERENCE

EAN CODE



ROND GM / ROUND LS



CRISTAL INCOLORE
 CLEAR CRYSTAL

10509200



ROND MM / ROUND MS



CRISTAL INCOLORE
 CLEAR CRYSTAL

10509300



ROND PM / ROUND SS



CRISTAL INCOLORE
 CLEAR CRYSTAL

10509400



2015 - LALIQUE

Détails techniques et instructions de montage : cf fiche architecture. / Technical datas & mounting instructions: see architecture files.

LES CAUSEUSES



499 mm / 19.65"

25 kg / 55.12 pounds

MM, CENTRAL / MS, CENTRAL

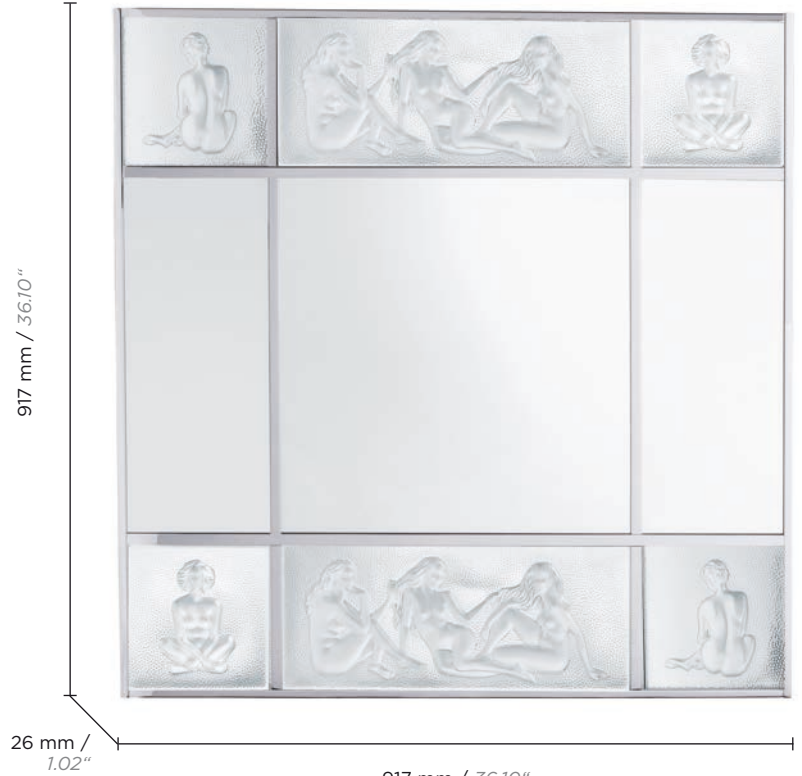

917 mm / 36.10"

26 mm / 1.02"

917 mm / 36.10"

50 kg / 110.23 pounds

GM / LS

FINITION / *FINISHING*

REFERENCE

EAN CODE



CRISTAL INCOLORE - *CLEAR CRYSTAL*
CHROMÉ - *CHROME*

1021500



MM, CENTRAL / MS, CENTRAL



CRISTAL INCOLORE - *CLEAR CRYSTAL*
CHROMÉ - *CHROME*

1021400



GM / LS

1991 - Marie-Claude Lalique

Détails techniques et instructions de montage : cf fiche architecture. / *Technical datas & mounting instructions: see architecture files.*

Équerres murales de fixation apparentes. / *Visible fixing wall brackets.*

MERLES ET RAISINS



25 kg / 55.12 pounds

FINITION / *FINISHING*

REFERENCE

EAN CODE



CRISTAL INCOLORE - *CLEAR CRYSTAL*
CHROMÉ - *CHROME*

10364400



0 90592 92305 4

2014 - LALIQUE

Détails techniques et instructions de montage : cf fiche architecture. / *Technical datas & mounting instructions: see architecture files.*

Équerres murales de fixation non apparentes. / *Invisible fixing wall brackets.*

Océania



Ø 860 mm / 33.86"

37 kg / 81.57 pounds

FINITION / *FINISHING*

REFERENCE

EAN CODE



CRISTAL INCOLORE
CLEAR CRYSTAL

1021900



2001 - LALIQUE

Détails techniques et instructions de montage : cf fiche architecture. / *Technical datas & mounting instructions: see architecture files.*
Équerres murales de fixation non apparentes. / *Invisible fixing wall brackets.*

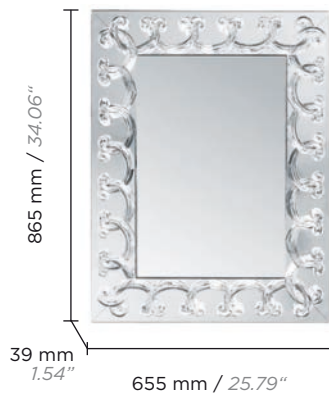

25 kg / 55.12 pounds

PM / SS

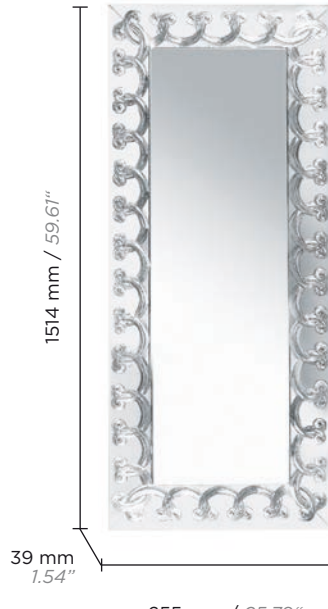

50 kg / 110.23 pounds

TOUTE HAUTEUR / FULL LENGTH



46 kg / 101.41 pounds

GM / LS

FINITION / FINISHING

REFERENCE

EAN CODE

PM / SS



1950 - Marc Lalique

CRISTAL INCOLORE
CLEAR CRYSTAL

1020800



GM / LS



1950 - Marc Lalique

CRISTAL INCOLORE
CLEAR CRYSTAL

1021300



**TOUTE HAUTEUR /
FULL LENGTH**



1950 - Marc Lalique

CRISTAL INCOLORE
CLEAR CRYSTAL

1021800



Détails techniques et instructions de montage : cf fiche architecture. / Technical datas & mounting instructions: see architecture files.
Équerres murales de fixation non apparentes. / Invisible fixing wall brackets.

POIGNÉES DE PORTE ET BOUTONS - *DOOR HANDLES AND KNOBS*

FAUNES

POIGNÉES DE PORTE / *DOOR HANDLES*

PORTE EN BOIS - *WOOD DOOR*



1 FACE
1 SIDE



2 FACES
2 SIDES



DOUBLE PORTE EN BOIS - 1 FACE :
commander la référence : 1028450 x2 ou 1028750 x2
DOUBLE PORTE EN BOIS - 2 FACES :
commander la référence : 1028450 x4 ou 1028750 x4

DOUBLE WOOD DOOR - 1 SIDE:
ordering reference: 1028450 x2 or 1028750 x2
DOUBLE WOOD DOOR - 2 SIDES:
ordering reference: 1028450 x4 or 1028750 x4



SIMPLE PORTE EN BOIS - 1 FACE :
commander la référence : 1028450 x1 ou 1028750 x1
SIMPLE PORTE EN BOIS - 2 FACES :
commander la référence : 1028450 x2 ou 1028750 x2

SINGLE WOOD DOOR - 1 SIDE:
ordering reference: 1028450 x1 or 1028750 x1
SINGLE WOOD DOOR - 2 SIDES:
ordering reference: 1028450 x2 or 1028750 x2

PORTE EN BOIS ET MIROIR *WOOD AND MIRROR DOOR*



1 FACE
1 SIDE



2 FACES
2 SIDES

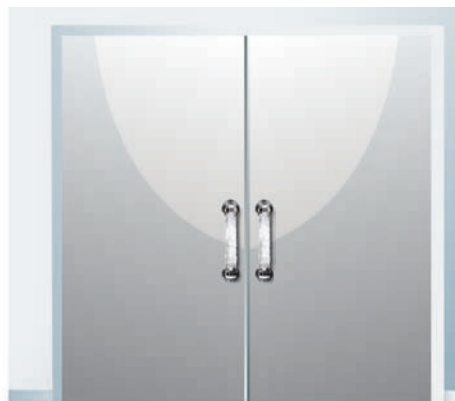

DOUBLE PORTE EN BOIS ET MIROIR - 1 FACE :
commander la référence : 1028490 x2 ou 1028790 x2
DOUBLE PORTE EN BOIS ET MIROIR - 2 FACES :
commander la référence : 1028490 x4 ou 1028790 x4

DOUBLE WOOD AND MIRROR DOOR - 1 SIDE:
ordering reference: 1028490 x2 or 1028790 x2
DOUBLE WOOD AND MIRROR DOOR - 2 SIDES:
ordering reference: 1028490 x4 or 1028790 x4

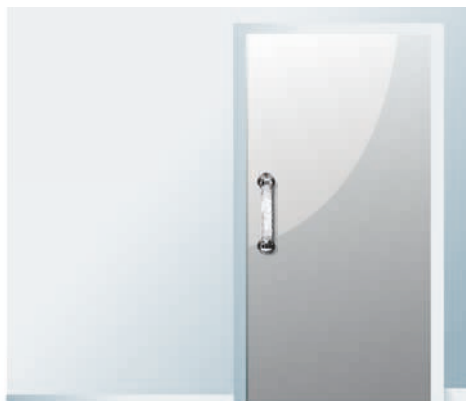

SIMPLE PORTE EN BOIS ET MIROIR - 1 FACE :
commander la référence : 1028490 x1 ou 1028790 x1
SIMPLE PORTE EN BOIS ET MIROIR - 2 FACES :
commander la référence : 1028490 x2 ou 1028790 x2

SINGLE WOOD AND MIRROR DOOR - 1 SIDE:
ordering reference: 1028490 x1 or 1028790 x1
SINGLE WOOD AND MIRROR DOOR - 2 SIDES:
ordering reference: 1028490 x2 or 1028790 x2

PORTE EN VERRE - *GLASS DOOR*



1 FACE
1 SIDE



2 FACES
2 SIDES

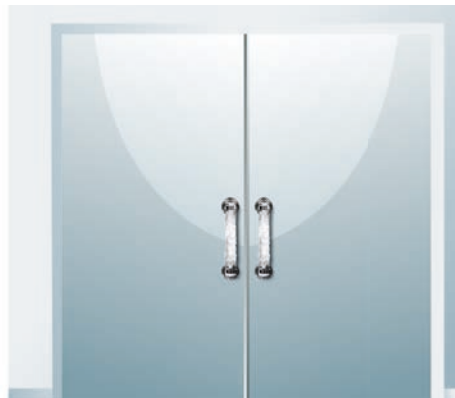

DOUBLE PORTE EN VERRE - 1 FACE :
commander la référence : 1028400 x2 ou 1028700 x2
DOUBLE PORTE EN VERRE - 2 FACES :
commander la référence : 1028300 x2 ou 1028600 x2

DOUBLE GLASS DOOR - 1 SIDE:
ordering reference: 1028400 x2 or 1028700 x2
DOUBLE GLASS DOOR - 2 SIDES:
ordering reference: 1028300 x2 or 1028600 x2

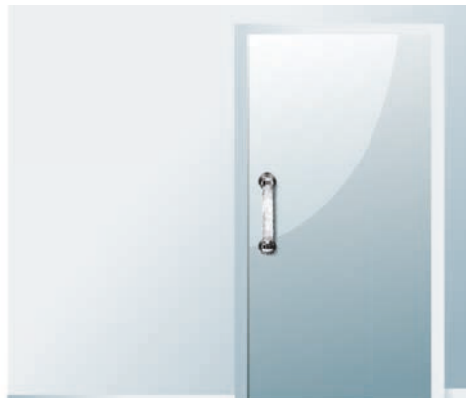

SIMPLE PORTE EN VERRE - 1 FACE :
commander la référence : 1028400 x1 ou 1028700 x1
SIMPLE PORTE EN VERRE - 2 FACES :
commander la référence : 1028300 x1 ou 1028600 x1

SINGLE GLASS DOOR - 1 SIDE:
ordering reference: 1028400 x1 or 1028700 x1
SINGLE GLASS DOOR - 2 SIDES:
ordering reference: 1028300 x1 or 1028600 x1

POIGNÉES DE PORTE ET BOUTONS - *DOOR HANDLES AND KNOBS*

FAUNES

POIGNÉES DE PORTE / *DOOR HANDLES*



FINITION / *FINISHING*

REFERENCE

EAN CODE

PORTE SIMPLE EN BOIS - *WOOD SINGLE DOOR*



1 POIGNÉE
1 HANDLE

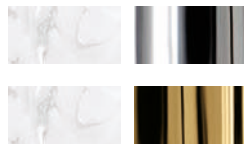

CRISTAL INCOLORE - *CLEAR CRYSTAL*
CHROMÉ - *CHROME*

1028450



CRISTAL INCOLORE - *CLEAR CRYSTAL*
DORÉ - *GILDED*

1028750



PORTE SIMPLE EN BOIS ET MIROIR - *WOOD AND MIRROR SINGLE DOOR*



1 POIGNÉE
1 HANDLE

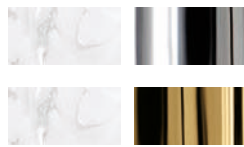

CRISTAL INCOLORE - *CLEAR CRYSTAL*
CHROMÉ - *CHROME*

1028490



CRISTAL INCOLORE - *CLEAR CRYSTAL*
DORÉ - *GILDED*

1028790



PORTE SIMPLE EN VERRE - *GLASS SINGLE DOOR*



1 POIGNÉE
1 HANDLE

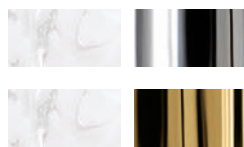

CRISTAL INCOLORE - *CLEAR CRYSTAL*
CHROMÉ - *CHROME*

1028400



CRISTAL INCOLORE - *CLEAR CRYSTAL*
DORÉ - *GILDED*

1028700



2 POIGNÉES
FACE À FACE*
2 HANDLES
FACE TO FACE*

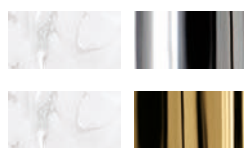

CRISTAL INCOLORE - *CLEAR CRYSTAL*
CHROMÉ - *CHROME*

1028300



CRISTAL INCOLORE - *CLEAR CRYSTAL*
DORÉ - *GILDED*

1028600



1962 - Marc Lalique

Détails techniques et instructions de montage : cf fiche architecture. / *Technical datas & mounting instructions: see architecture files.*

Épaisseur de la porte à préciser lors de la commande. / *Door thickness to be precised when ordering.*

*Une poignée sur chaque face de la porte. / **One handle on each side of the door.*

POIGNÉES DE PORTE ET BOUTONS - *DOOR HANDLES AND KNOBS*

BUCOLIQUE

BOUTONS / *KNOBS*



FINITION / *FINISHING*



CRISTAL INCOLORE - *CLEAR CRYSTAL*
CHROMÉ - *CHROME*

REFERENCE

1034000

EAN CODE



CRISTAL INCOLORE - *CLEAR CRYSTAL*
DORÉ - *GILDED*

10346600



2007 - LALIQUE

Détails techniques et instructions de montage : cf fiche architecture. / *Technical datas & mounting instructions: see architecture files.*

POIGNÉES DE PORTE ET BOUTONS - *DOOR HANDLES AND KNOBS*

MASQUE DE FEMME

BOUTONS / *KNOBS*

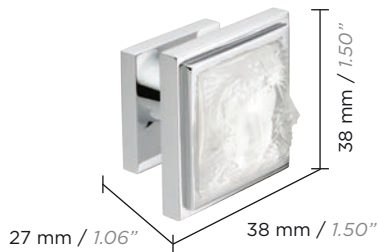

MM / MS

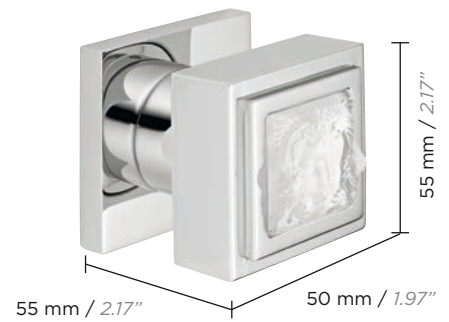

GM / LS

FINITION / *FINISHING*

REFERENCE

EAN CODE



CRISTAL INCOLORE
CLEAR CRYSTAL
CHROME - *CHROME*

10173100



CRISTAL INCOLORE
CLEAR CRYSTAL
DORÉ - *GILDED*

10173200



1 BOUTON MM - 1 MS *KNOB*



CRISTAL INCOLORE
CLEAR CRYSTAL
CHROME - *CHROME*

10172700



CRISTAL INCOLORE
CLEAR CRYSTAL
DORÉ - *GILDED*

10172800



1 BOUTON GM - 1 LS *KNOB*

2011 - LALIQUE & THG

Détails techniques et instructions de montage : cf fiche architecture. / *Technical datas & mounting instructions: see architecture files.*

POIGNÉES DE PORTE ET BOUTONS - *DOOR HANDLES AND KNOBS*

MÉTROPOLIS

BOUTONS / *KNOBS*

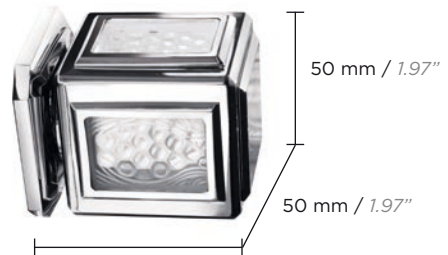
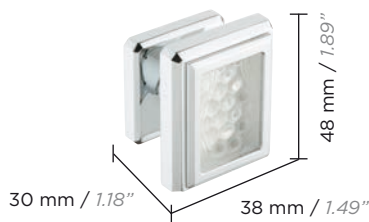

0,22 kg / 0.49 pounds

0,90 kg / 1.98 pounds

MM / MS

GM / LS

FINITION / *FINISHING*

REFERENCE

EAN CODE



CRISTAL INCOLORE
CLEAR CRYSTAL
CHROME - *CHROME*

1033500



CRISTAL INCOLORE
CLEAR CRYSTAL
DORÉ - *GILDED*

1033510



1 BOUTON MM - 1 MS KNOB



CRISTAL INCOLORE
CLEAR CRYSTAL
CHROME - *CHROME*

1033100



CRISTAL INCOLORE
CLEAR CRYSTAL
DORÉ - *GILDED*

1033110



1 BOUTON GM - 1 LS KNOB

2006 - LALIQUE & THG

Détails techniques et instructions de montage : cf fiche architecture. / *Technical datas & mounting instructions: see architecture files.*

PERLES BOUTONS / *KNOBS*

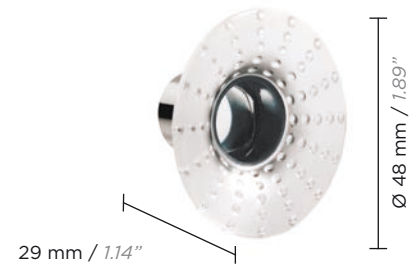

0,06 kg / 0.13 pounds

FINITION / *FINISHING*

REFERENCE

EAN CODE



CRISTAL INCOLORE - *CLEAR CRYSTAL*
CHROMÉ - *CHROME*

1034100



2007 - LALIQUE

Détails techniques et instructions de montage : cf fiche architecture. / *Technical datas & mounting instructions: see architecture files.*

PANNEAUX DÉCORATIFS - *DECORATIVE PANELS*



PANNEAUX DÉCORATIFS - *DECORATIVE PANELS*

I. MISES EN OEUVRE DES PANNEAUX DÉCORATIFS / *INSTALLATION OF THE DECORATIVE PANELS*

1 - MIS EN OEUVRE DIRECTEMENT PAR LE CLIENT / *INSTALLATION DIRECTLY BY THE CLIENT:*

- Il peut s'agir d'un panneau miroité ou non miroité seul.
 - Le client reçoit des panneaux décoratifs dans leur conditionnement.
 - LALIQUE n'intervient pas dans le process de montage ni sur la mise en oeuvre.
 - Tolérance des dimensions de +/- 2 mm, une tolérance plus précise (+/- 1 mm) peut être obtenue sur demande et sur devis.
- *Mirrored or non-mirrored panel.*
 - *The client receives the decorative panels in their packaging.*
 - *LALIQUE is not involved in the mounting process and does not provide guidances for the installation.*
 - *Dimensions may vary between +/-2 mm. More precise dimensions can be achieved on demand and quotation.*



Panneau de cristal miroité ou non miroité
Crystal panel mirrored or non-mirrored

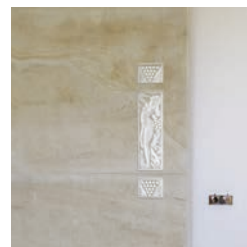

2 - MISE EN OEUVRE DANS UNE MONTURE LALIQUE / *IMPLEMENTATION IN A LALIQUE MOUNT:*

- Il s'agit d'un panneau miroité ou non-miroité mis en monture par LALIQUE.
 - Le client reçoit des panneaux décoratifs dans leur conditionnement avec la monture métallique associée, à monter sur place ou déjà montée, selon les projets.
 - La monture permet de combiner plusieurs panneaux ensemble.
 - La monture LALIQUE présente l'avantage de rattraper les différences d'épaisseur des panneaux.
- *Mirrored or non-mirrored panel in a LALIQUE mount.*
 - *The client receives the decorative panels including the associated metallic mount which has to be mounted on the spot or is already mounted, depending on the project.*
 - *The mount allows the combining of various panels together.*
 - *The LALIQUE mount makes up for the possible difference of thickness to one panel from another.*

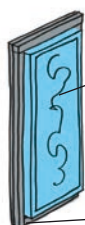

Panneau de cristal miroité ou non miroité
Crystal panel mirrored or non-mirrored

Monture / *Mount*

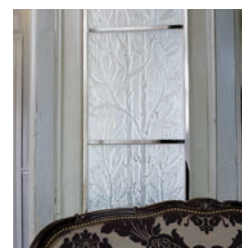

3 - MISE EN OEUVRE EN PANNEAU D'ESPACE / *IMPLEMENTATION OF AN INTERIOR PANEL:*

- Il s'agit de panneaux de verre extra-blancs aux formats et dimensions sur-mesure contenant des panneaux de cristal et/ou des motifs sablés à la main.
 - Le panneau d'espace permet d'étendre la surface du panneau de cristal tout en conservant la transparence. Cela rend possible l'intégration d'une composition de grande dimensions d'un seul tenant.
 - La précision des dimensions facilite l'intégration dans un contexte architectural.
 - Le collage UV est une opération irréversible.
 - Voir chapitre panneaux d'espace pour plus de détails.
- *Panels with extra-white glass in bespoke formats and sizes, including crystal panels and/or by hand sandblasted motifs.*
 - *The interior panel allows extending the crystal panel while maintaining the transparency. This makes it possible to integrate a large size composition in one piece.*
 - *The precision of the dimensions facilitates integration in an architectural context.*
 - *UV gluing is an irreversible operation.*
 - *For more details, please refer to the interior panels chapter.*



Panneau de cristal non miroité collé UV sur une dalle en verre
Non mirrored crystal panel, UV glued on a glass slab

Supprt en verre / *Glass mount*



PANNEAUX DÉCORATIFS - *DECORATIVE PANELS*

II. LES ÉTAPES DE FABRICATION D'UN PANNEAU DÉCORATIF

STEP BY STEP MANUFACTURING PROCESS OF A DECORATIVE PANEL



Chaque panneau est fabriqué artisanalement selon la technique du pressé. Pour chaque panneau, un moule en fonte est fabriqué.

Les dimensions de chaque panneau sont conditionnées par les dimensions du moule correspondant.

La taille des panneaux ne peut être modifiée sans refaire un nouveau moule.

Each panel is handcrafted according to the pressing technique. A cast-iron mold is manufactured for each panel. The dimensions of each panel are related to the dimensions of the corresponding mold.

The size of the panel cannot be modified without manufacturing a new mold.

1 - VERRE CHAUD / *HOT GLASS:*

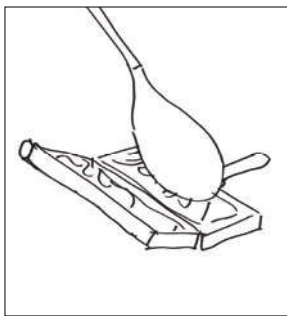

Cristal en fusion cueilli et coulé dans le moule
Melted crystal is gathered and cast into the mold

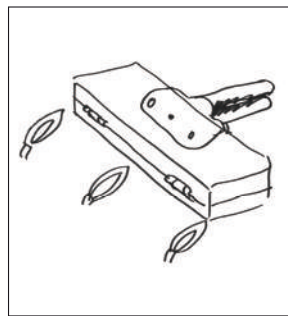

Le moule est pressé
The mold is pressed

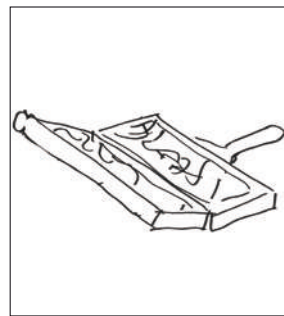

Le panneau est démoulé
The panel is taken out of the mold

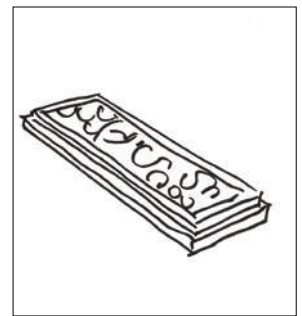

Le panneau est recuit (refroidissement contrôlé)
The panel is annealed (controlled cooling off)

2 - VERRE FROID / *COLD GLASS:*

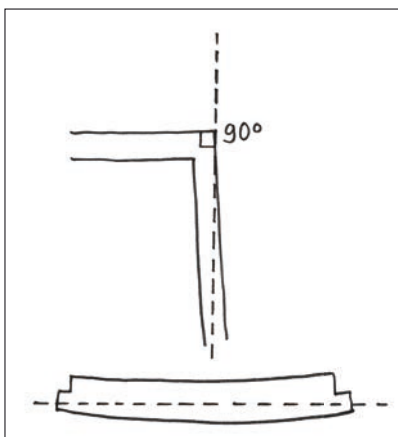

Travail sur la géométrie du panneau.
Tolérance variable en raison du caractère artisanal du processus de fabrication
There can be variance due to the craftsmanship in the process

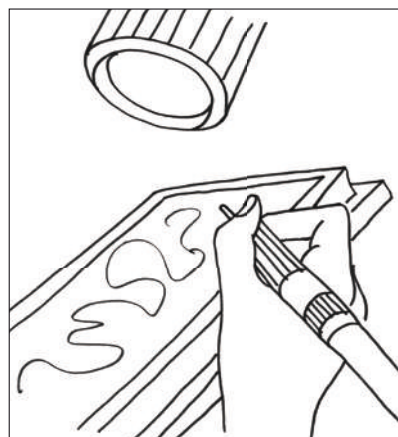

Travail sur la finition du motif
Finishing of the design



Travail sur l'éclat et la finition du cristal
Polishing of the crystal

De nombreuses autres opérations au verre froid peuvent être réalisées : émaillage, tamponnage, etc. La non-planéarité fait partie inhérente du processus artisanal de fabrication et ne peut être considérée comme un défaut.

Several other operations can be completed in the cold glass workshop: enamelling, stamping etc. The fact that the panels are not completely even is part of the handmade process and cannot be considered as defect.

PANNEAUX DÉCORATIFS - *DECORATIVE PANELS*

III. FORMATS ET DIMENSIONS POSSIBLES / *AVAILABLE SIZES*

1 - FORMATS DES PANNEAUX EXISTANTS (notion d'échelle)

FORMATS OF EXISTING PANELS (notions of scale):



Madison panel
H 182 / L 166 mm
H 7.17" / L 6.54"
0.77 kg / 1.70 pounds



Aster panel
H 290 / L 290 mm
H 11.42" / L 11.42"
2.20 kg / 4.85 pounds

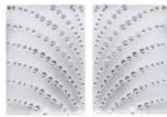

Coutard panel left or right
H 319 / L 235 mm
H 12.56" / L 9.25"
3.80 kg / 8.38 pounds



Lauriers panel
H 433 / L 374 mm
H 17.05" / L 14.72"
7.50 kg / 16.53 pounds



Joueur de pipeau panel
left or right
H 458 / L 153 mm
H 18.03" / L 6.02"
2.80 kg / 6.17 pounds

2 - UTILISATION D'UN PANNEAU DÉCORATIF POUR COUVRIR UN MUR (principe général)

USE OF A DECORATIVE PANEL TO COVER A WALL (general principle):

Panneau décoratif Lauriers
Dimensions fixes 37 x 43 cm
Lauriers decorative panel
Fixed dimensions 14.72" x 17.05"

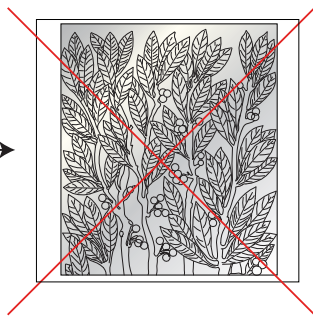

Pas d'agrandissement
du panneau envisageable sans
refaire un nouveau moule.
*It is not possible to enlarge an
existing crystal panel without
producing a new cast mold.*

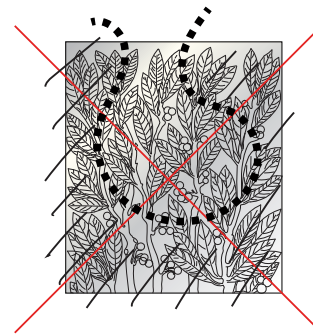

Découpe dans le panneau
impossible (découpe parfois
possible après étude).
*It's not always
possible to cut in a crystal
panel.*

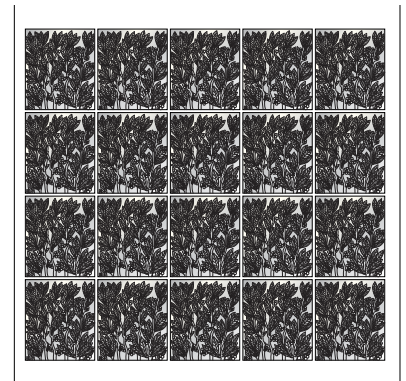

Pour couvrir la surface d'un mur, il faut
assembler plusieurs panneaux.
*To cover a wall surface, several panels
have to be assembled.*

PANNEAUX DÉCORATIFS - *DECORATIVE PANELS*

IV. FINITIONS ESTHÉTIQUES DES PANNEAUX DÉCORATIFS *FINISHINGS AESTHETICS OF DECORATIVE PANELS*

1 - NON MIROITÉ / *NON MİRRORED*



Panneau Lauriers
Lauriers panel

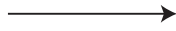

Exemple de mise en oeuvre :

Panneaux d'espace composés de panneaux Lauriers collés UV sur une dalle de verre satinée en dégradé. L'ensemble est inséré dans les portes du restaurant le George, Hôtel le George V (monture des portes non fournies par LALIQUE).

Example of installation:

Interior panels composed of Lauriers panels, UV glued on a gradient satin glass slab. These panels are inserted into the doors of the restaurant Le George, of the Hôtel George V in Paris (door frame not provided by LALIQUE).

2 - MIROITÉ / *MİRRORED*



Panneau Lauriers
Lauriers panel



Exemple de mise en oeuvre :

Panneaux Lauriers miroités insérés dans le meuble d'accueil du restaurant le George, Hôtel le George V (monture sur-mesure non fournie par LALIQUE).

Example of installation:

Mirrored Lauriers panels inserted in the reception desk of the restaurant le George, Hôtel George V (custom-made mount, not provided by LALIQUE).

3 - AUTRES FINITIONS SUR DEMANDE / *OTHER BESPOKE FINISHINGS*

Les panneaux de cristal peuvent faire l'objet de finitions esthétiques spécifiques sur demande. La faisabilité sera étudiée selon la demande.

The panels can have specific aesthetics with customized finishing. The feasibility has to be studied based on the project.

PANNEAUX DÉCORATIFS - *DECORATIVE PANELS*

V. FINITIONS TECHNIQUES DES PANNEAUX DÉCORATIFS

TECHNICAL FINISHINGS OF THE DECORATIVE PANELS

Feuillure : « Une feuillure est une entaille pratiquée à moitié de l'épaisseur d'un panneau de cristal ».

Rabbet: "A rabbet is a recess or a groove cut into the edge of the crystal panel."

1 - SANS FEUILLURE / *WITHOUT RABBET*

Caractéristiques :

Un panneau sans feuillure peut être mis en œuvre dans une monture ou collé UV dans le cadre d'un projet de panneau d'espace, sans modifications.

Features:

A panel without rabbet can be integrated in a mount or UV glued as part of an interior panel project without any modifications.

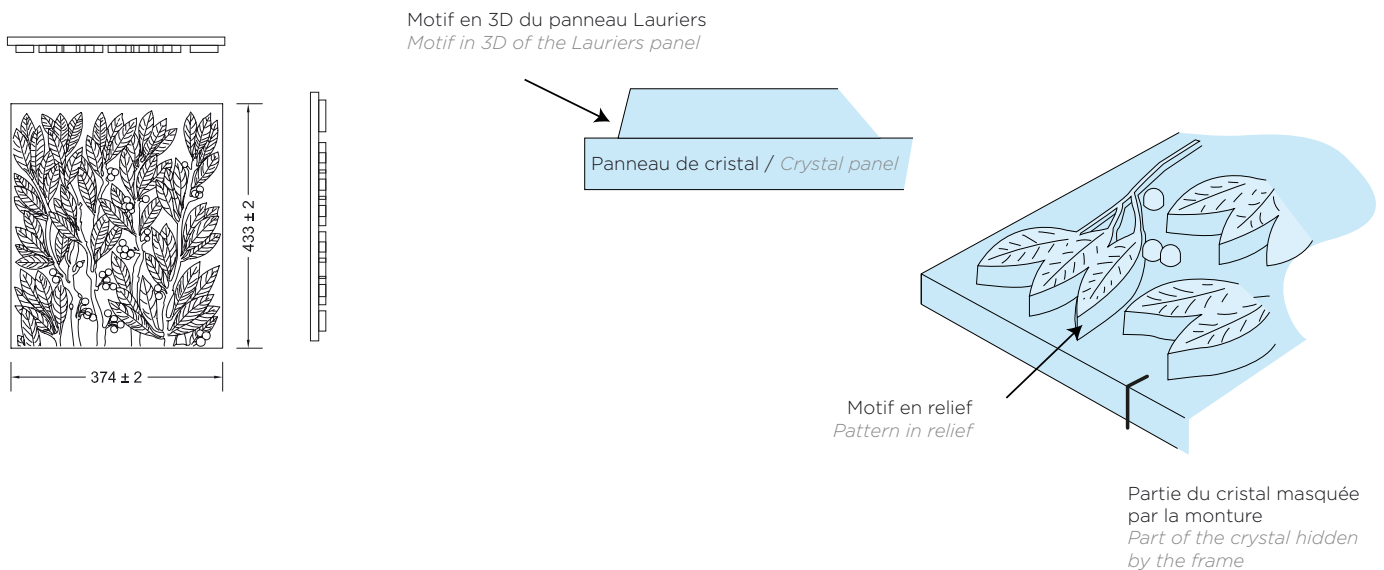

2 - AVEC FEUILLURE / *WITH RABBET*

Caractéristiques :

- Les dimensions du panneau incluent la feuillure qui sera masquée dans la monture.
- La feuillure est supprimée par une opération manuelle lorsque le panneau est collé UV dans le cadre d'un projet de panneau d'espace.

Features:

- *Panel dimensions include the rabbet which will be hidden in the frame.*
- *When the panels are UV glued as part of an interior panel project, the rabbet will be removed by a manual process.*

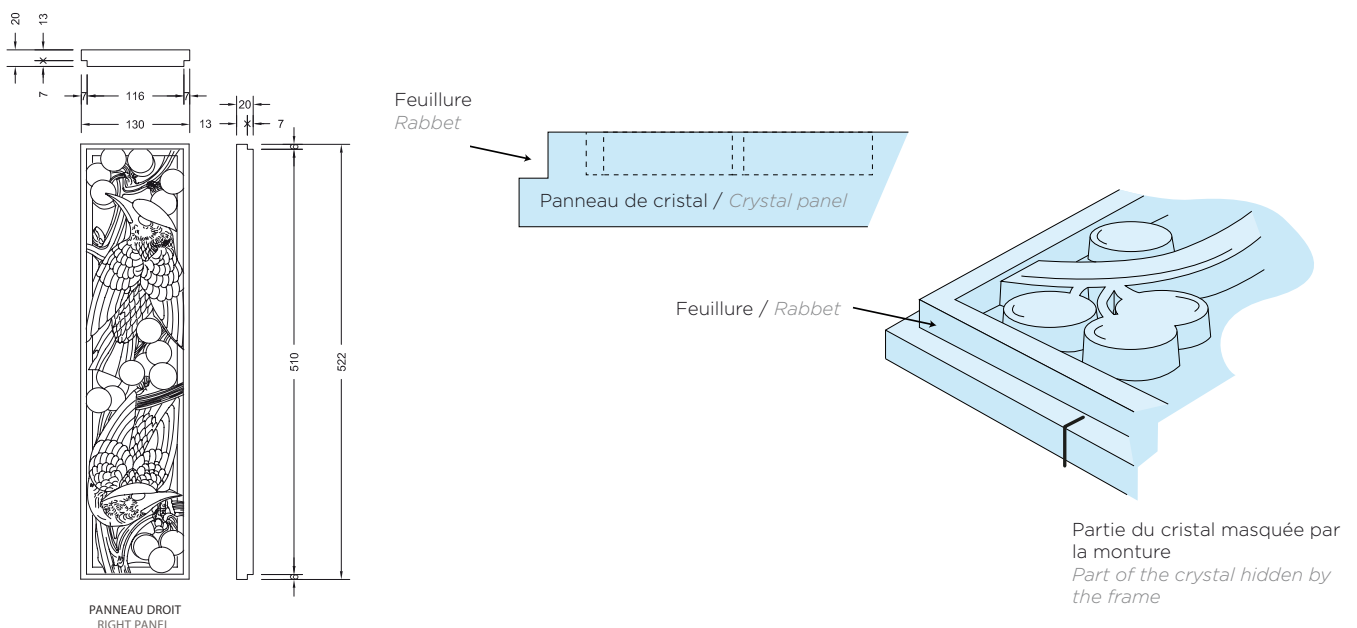

VI. INTÉGRATION EN MONTURE ET EN LUMIÈRE DES PANNEAUX DÉCORATIFS *USING DECORATIVE PANELS IN FRAMES AND IN LIGHTS*

1 - LES MONTURES EN « L » ET EN « T » / *“L” AND “T” SHAPED FRAMES*

1.1 - LA MONTURE EN « L » POUR ACCROCHAGE COMME UN TABLEAU *L-SHAPED FRAME TO BE HUNG LIKE A PICTURE*



Exemple d'une composition Merles et Raisins accrochée au mur comme un tableau avec une monture en L

Composition example Merles et Raisins (Blackbirds and Grapes) hung on the wall like a picture with an L-shaped frame

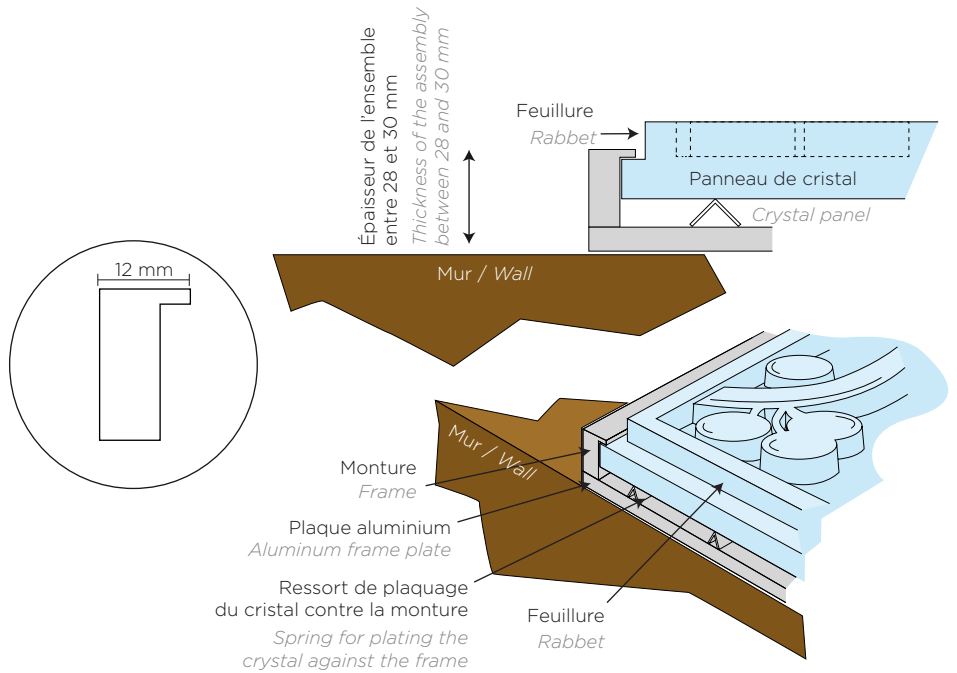

1.2 - LA MONTURE EN « T » POUR ACCROCHAGE ENCASTRÉ DANS LE MUR *T-SHAPED FRAME FOR HANGING RECESSED INTO THE WALL*



Exemple d'un ensemble de panneaux Lauriers encastrés dans le mur avec une monture en T

Example of a set of Lauriers (laurel) panels recessed into the wall with a T-shaped frame

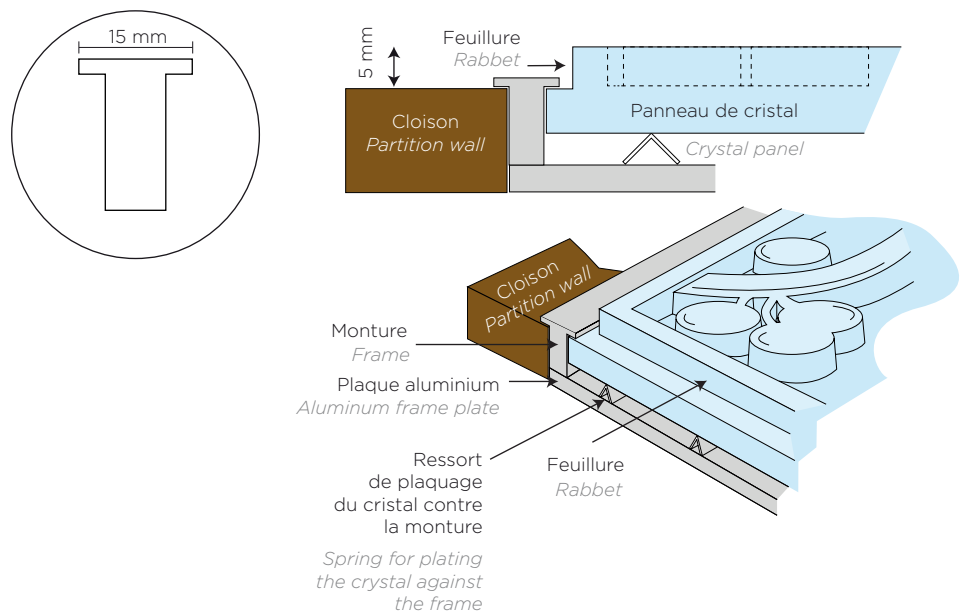

PANNEAUX DÉCORATIFS - *DECORATIVE PANELS*

VII. SUGGESTIONS D'INTÉGRATION / *SUGGESTIONS FOR INTEGRATION*



Frises de panneaux décoratifs entourant un miroir (miroir non fourni)
Friezes of decorative panels surrounding a mirror (mirror not provided)



Composition XXL de panneaux décoratifs accrochée sur un mur
Grand composition of decorative panels hung on a wall



Frises de panneaux décoratifs encadrant les portes d'une cave à vin
Friezes of decorative panels integrated in the doors of a wine cellar



Panneaux Merles et Raisins insérés dans le bar et dans le mur
Merles et Raisins panels integrated in a bar and a wall

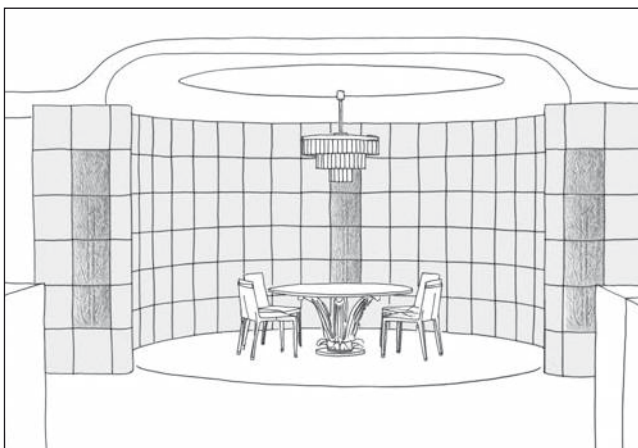

Ensembles de panneaux Lauriers dans l'entrée d'une maison privée
Sets of Lauriers panels at the entrance of a private house



Ensembles de panneaux Coutard insérés sur des colonnes
Set of Coutard panels integrated in pillars

INFORMATIONS INDISPENSABLES À PRÉCISER POUR TOUTE DEMANDE DE PANNEAUX DÉCORATIFS :

Ces informations sont nécessaires pour la définition et l'étude de prix de la demande de panneaux décoratifs :

- I. Dimensions globales du projet
- II. Environnement d'intégration des panneaux décoratifs (contexte, type d'environnement, nature du support d'accrochage)
- III. Mise en œuvre des panneaux pour assemblage entre eux. En fonction du contexte et de l'une des 3 options de mise en œuvre souhaitée par le client, les questions suivantes s'appliquent :

OPTION 1 : Mise en œuvre des panneaux par le client. LALIQUE FOURNIT les panneaux seuls :

- Choix du ou des panneau(x) décoratif(s) et quantité(s)
- Finition des panneaux (miroités ou non-miroités)
- Précisions sur la tolérance de géométrie des panneaux (définition d'un gabarit de contrôle entre le client et Lalique si nécessaire)
- Modification du panneau cristal selon les contraintes du projet du client (à confirmer par Lalique). Exemple : enlèvement de la feuilure, découpe dans le format original, affinement de l'épaisseur du panneau, etc. Toute modification après production du panneau génère obligatoirement un surcoût.

OPTION 2 : Mise en œuvre des panneaux par LALIQUE en monture métal. LALIQUE FOURNIT la monture et les panneaux :

- Choix du ou des panneau(x) décoratif(s) et quantité(s)
- Finition de la monture souhaitée (échantillon à fournir si finition sur-mesure)
- Éclairage dans la monture (information à donner en amont du projet, contraintes techniques)
- Type d'accrochage souhaité (intégration, accrochage comme un tableau, etc.)

OPTION 3 : Mise en œuvre des panneaux par LALIQUE en panneau d'espace :

- Choix du ou des panneau(x) décoratif(s) et quantité(s)
- Dimensions hors tout et épaisseur du panneau d'espace
- Dimensions du clair de vue (voir chapitre panneau d'espace)
- Finition(s) technique(s) du panneau d'espace (partie verre) : sécurisation, options du verre dont l'usinage (pour insert de charnières* et de poignées de porte*, etc.)
- Information sur la mise en lumière* prévue par le client

*Les systèmes lumineux, les montures, les charnières, les poignées de portes ou autres ne sont pas fournis par LALIQUE.

ESSENTIAL INFORMATION REQUIRED FOR ANY DECORATIVE PANEL:

The below information is required to develop the design and provide a quotation of a decorative panel:

- I. Dimensions of the project*
- II. Installation type and usage of the panel (wall, mirror, door insert, etc.)*
- III. Panel installation options. Depending on one of the 3 installation options chosen by the client, the following questions apply:*

OPTION 1: Installation by the client directly. LALIQUE provides only the panels:

- *Choice of the decorative panel(s) and amount*
- *Finishing of the panel (mirrored or non-mirrored)*
- *Confirming the geometrical shape of the panel (if necessary comparing to a template between the client and Lalique)*
- *Modification of the crystal panel according to the constraints of the client's project (to be confirmed by Lalique). Example: Removal of the rabbet, cutting of the original format, refinement of the thickness of the panel, etc. Any modification after production of the panel generates an additional cost.*

OPTION 2: Installation of the panels in a metallic mount. LALIQUE provides the mount and the panels:

- *Choice of the decorative panel(s) and amount.*
- *Finishing of the preferred mount (if it is a bespoke finishing a sample will be produced)*
- *Lighting in the mount (information to be provided with the project, technical constraints)*
- *Preferred mounting type (integration, assembly like a board etc.)*

OPTION 3: Installation of LALIQUE panels as interior panels

- *Choice of the decorative panel(s) and amount*
- *Overall dimensions and thickness of the interior panel*
- *Dimension of the inside measurement (refer to the interior panels chapter)*
- *Technical finishing(s) of the interior panel(s) (glass part): security, glass options therewith the using (for the insert of the hinges* and door handles*etc.)*
- *Information of the planned lighting**

* *Lighting systems, mountings, drillings and handles are not provided by LALIQUE.*

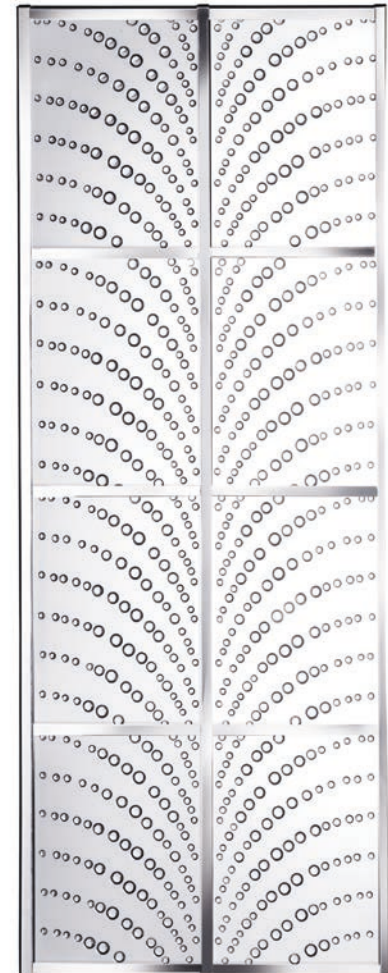
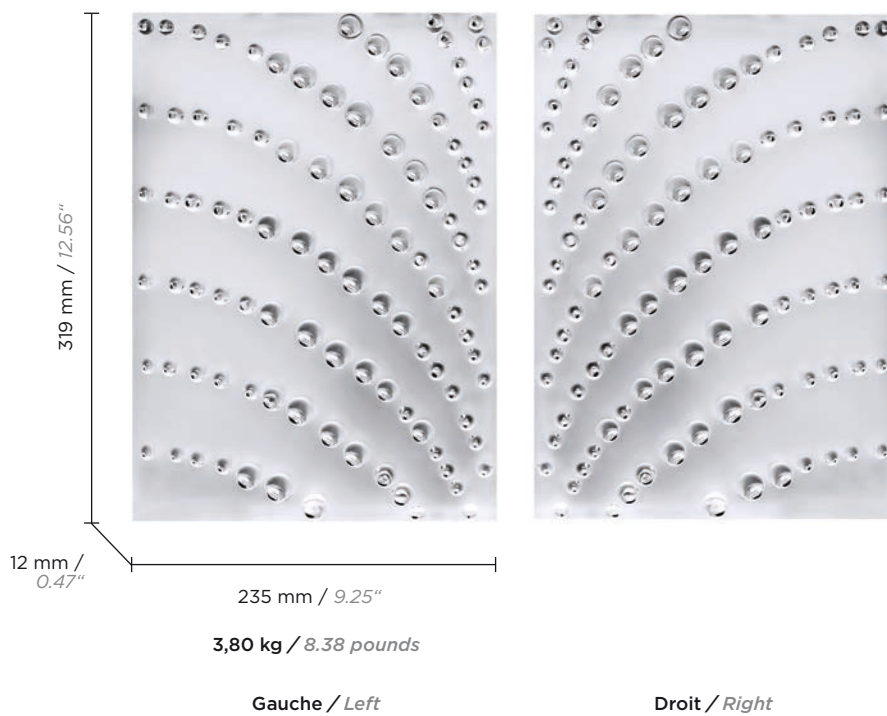

Modèle avec monture disponible uniquement sur commande spéciale.
Panels with frame are only available on special order.

DIMENSIONS DES PANNEAUX SANS FEUILLURE
PANELS DIMENSIONS WITHOUT RABBET

FINITION / FINISHING

REFERENCE

EAN CODE

DROIT



NON MIROITÉ
NON MIRRORRED

CRISTAL INCOLORE - *CLEAR CRYSTAL*

1023700



MIROITÉ
MIRRORED

CRISTAL INCOLORE - *CLEAR CRYSTAL*

1023710



GAUCHE



NON MIROITÉ
NON MIRRORRED

CRISTAL INCOLORE - *CLEAR CRYSTAL*

1023600



MIROITÉ
MIRRORED

CRISTAL INCOLORE - *CLEAR CRYSTAL*

1023610



1935 - René Lalique

Détails techniques et instructions de montage : cf fiche architecture. / *Technical datas & mounting instructions: see architecture files.*

FEMME BRAS LEVÉS



6,2 kg / 13.66 pounds

Modèle avec monture.
Panel with frame.

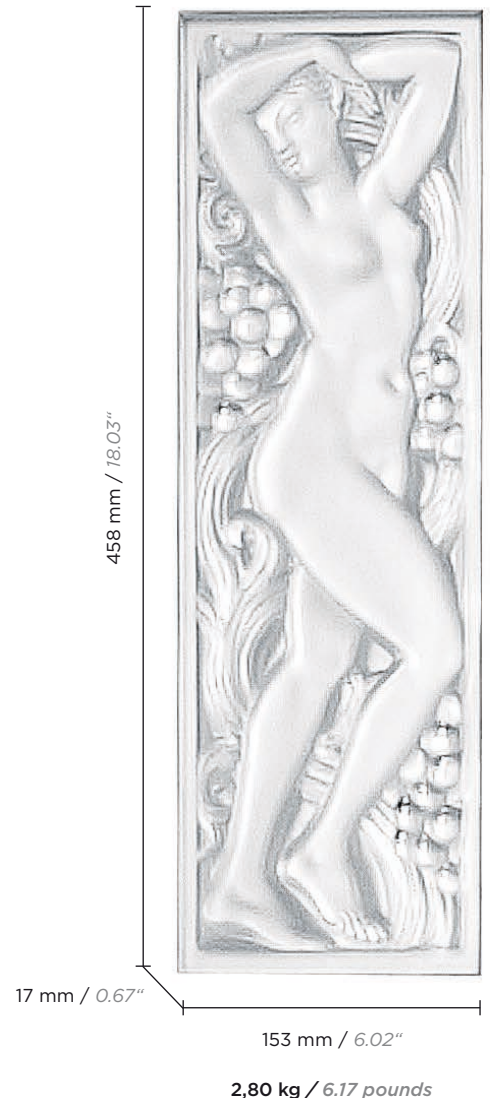

2,80 kg / 6.17 pounds

DIMENSIONS DES PANNEAUX AVEC FEUILLURE
PANELS DIMENSIONS WITH RABBET

FINITION / FINISHING

REFERENCE

EAN CODE



NON MIROITÉ
NON MIRRORED

CRISTAL INCOLORE - CLEAR CRYSTAL

1023200



MIROITÉ
MIRRORED

CRISTAL INCOLORE - CLEAR CRYSTAL

1023210



MIROITÉ ENCADRÉ
MIRRORED FRAMED

CRISTAL INCOLORE - CLEAR CRYSTAL

10625400



1928 - René Lalique

Détails techniques et instructions de montage : cf fiche architecture. / Technical datas & mounting instructions: see architecture files.

FEMME BRAS LEVÉS XXL

CIRE PERDUE / *LOST WAX*

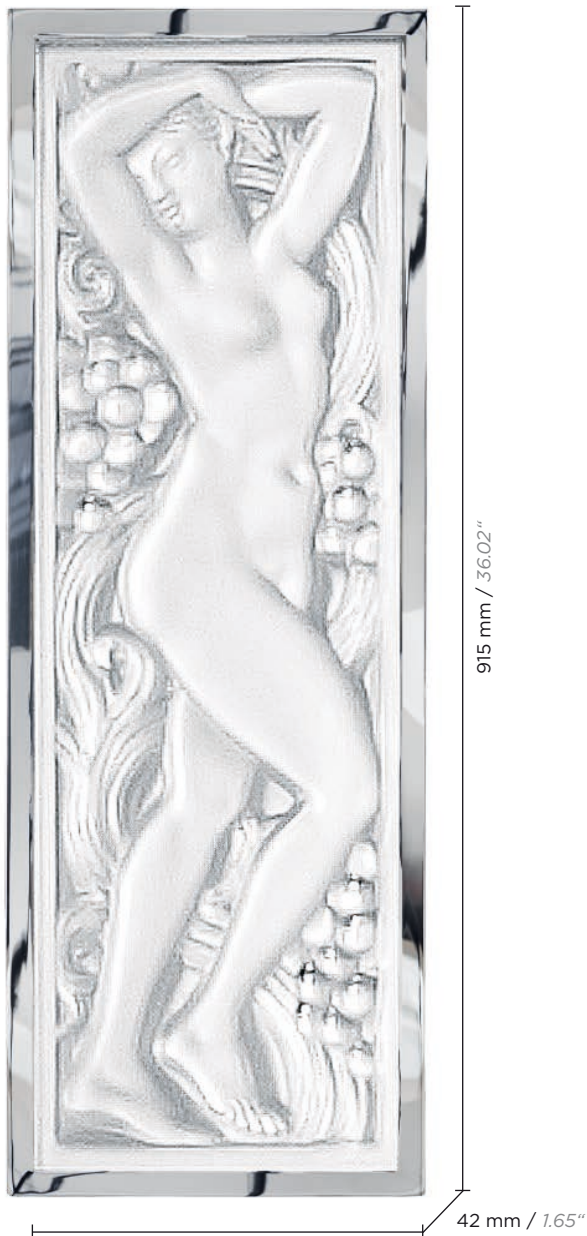

45 kg / 99.21 pounds
Modèle avec monture.
Panel with frame.

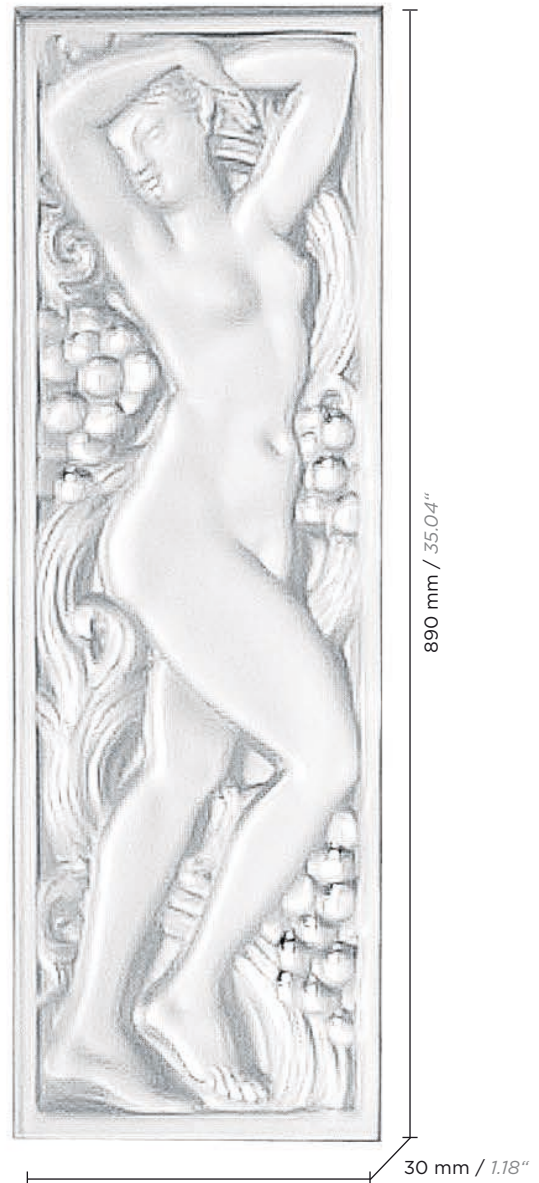

25 kg / 55.12 pounds

DIMENSIONS DES PANNEAUX AVEC FEUILLURE
PANELS DIMENSIONS WITH RABBET

FINITION / *FINISHING*

REFERENCE EAN CODE



NON MIROITÉ
NON MIRRORED

CRISTAL INCOLORE - *CLEAR CRYSTAL*

10596600



MIROITÉ
MIRRORED

CRISTAL INCOLORE - *CLEAR CRYSTAL*

10596700



MIROITÉ ENCADRÉ
MIRRORED FRAMED

CRISTAL INCOLORE - *CLEAR CRYSTAL*

10596800



1928 - René Lalique

Détails techniques et instructions de montage : cf fiche architecture. / *Technical datas & mounting instructions: see architecture files.*

PANNEAUX DÉCORATIFS - *DECORATIVE PANELS*

FEMME TÊTE LEVÉE

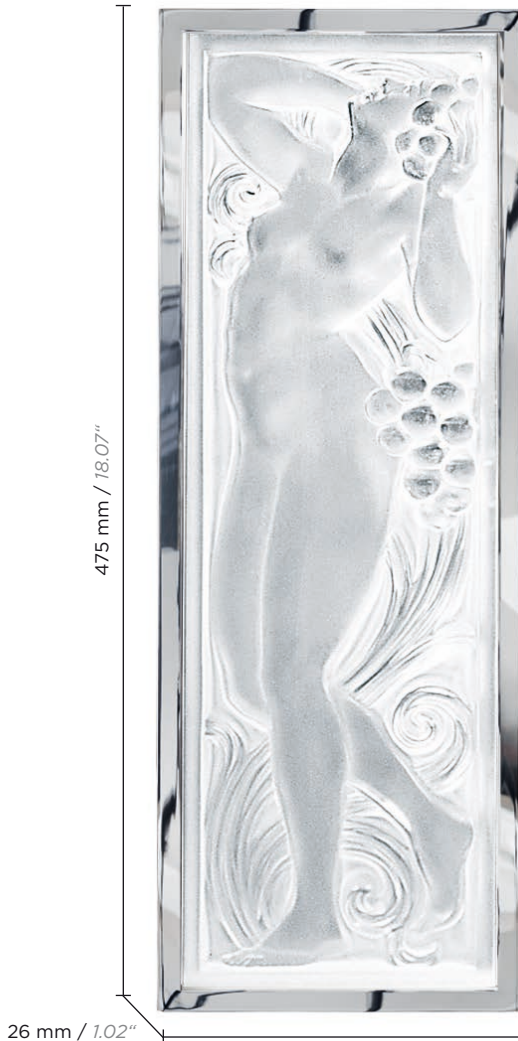

170 mm / 6.70"

6,2 kg / 13.66 pounds

Modèle avec monture.
Panel with frame.

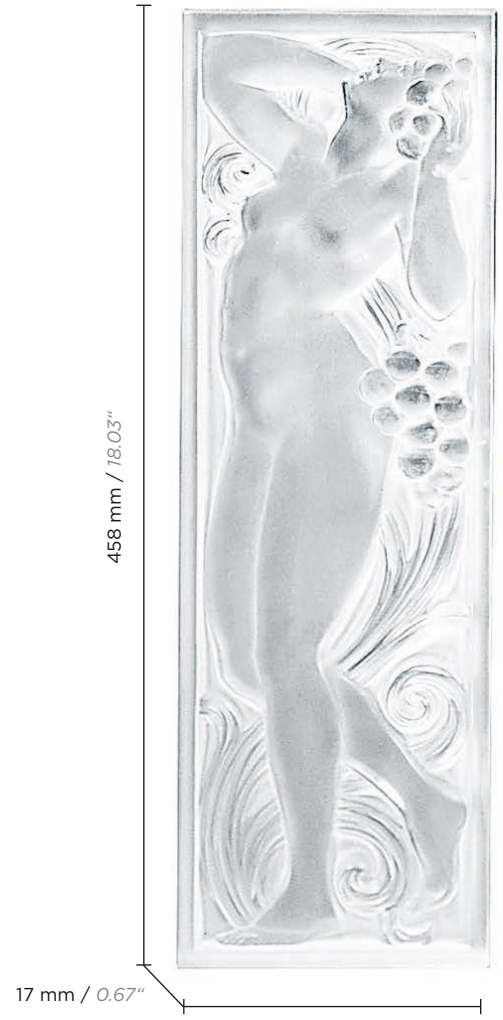

153 mm / 6.02"

2,80 kg / 6.17 pounds

DIMENSIONS DES PANNEAUX AVEC FEUILLURE
PANELS DIMENSIONS WITH RABBET

FINITION / FINISHING

REFERENCE

EAN CODE



NON MIROITÉ
NON MIRRORED

CRISTAL INCOLORE - CLEAR CRYSTAL

1023100



MIROITÉ
MIRRORED

CRISTAL INCOLORE - CLEAR CRYSTAL

1023110



MIROITÉ ENCADRÉ
MIRRORED, FRAMED

CRISTAL INCOLORE - CLEAR CRYSTAL

10625500



1928 - René Lalique

Détails techniques et instructions de montage : cf fiche architecture. / Technical datas & mounting instructions: see architecture files.



2,80 kg / 6.17 pounds

DIMENSIONS DES PANNEAUX AVEC FEUILLURE
PANELS DIMENSIONS WITH RABBET



Modèle avec monture.
Panel with frame.

6,2 kg / 13.66 pounds

FINITION / FINISHING

REFERENCE

EAN CODE



NON MIROITÉ
NON MIRRORED

CRISTAL INCOLORE - *CLEAR CRYSTAL*

10067800



MIROITÉ
MIRRORED

CRISTAL INCOLORE - *CLEAR CRYSTAL*

10067900



MIROITÉ ENCADRÉ
MIRRORED FRAMED

CRISTAL INCOLORE - *CLEAR CRYSTAL*

10625600



1928 - René Lalique

Détails techniques et instructions de montage : cf fiche architecture. / *Technical datas & mounting instructions: see architecture files.*

PANNEAUX DÉCORATIFS - *DECORATIVE PANELS*

JOUEUR DE PIPEAU



26 mm / 1.02"

170 mm / 6.70"

Modèle avec monture.
Panel with frame.

6,2 kg / 13.66 pounds

Gauche encadré / Left framed



17 mm / 0.67"

153 mm / 6.02"



2,80 kg / 6.17 pounds

Droit / Right

Droit encadré / Right framed

DIMENSIONS DES PANNEAUX AVEC FEUILLURE
PANELS DIMENSIONS WITH RABBET

FINITION / FINISHING

FINITION / FINISHING		REFERENCE	EAN CODE
GAUCHE 	NON MIROITÉ <i>NON MIRRORED</i>	CRISTAL INCOLORE - CLEAR CRYSTAL	1023300
	MIROITÉ <i>MIRRORED</i>	CRISTAL INCOLORE - CLEAR CRYSTAL	1023310
	MIROITÉ ENCADRÉ <i>MIRRORED FRAMED</i>	CRISTAL INCOLORE - CLEAR CRYSTAL	10625700
DROIT 	NON MIROITÉ <i>NON MIRRORED</i>	CRISTAL INCOLORE - CLEAR CRYSTAL	10040100
	MIROITÉ <i>MIRRORED</i>	CRISTAL INCOLORE - CLEAR CRYSTAL	10040200
	MIROITÉ ENCADRÉ <i>MIRRORED FRAMED</i>	CRISTAL INCOLORE - CLEAR CRYSTAL	10625800

1928 - René Lalique

Détails techniques et instructions de montage : cf fiche architecture. / Technical datas & mounting instructions: see architecture files.

PANNEAUX DÉCORATIFS - *DECORATIVE PANELS*

LAURIERS

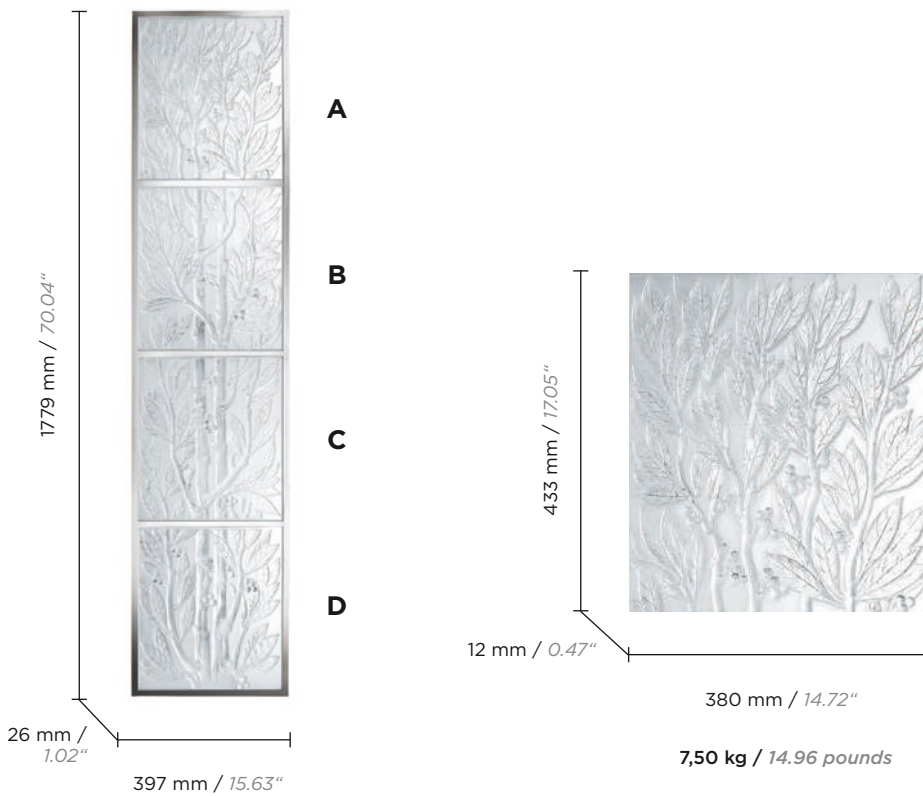

38,5 kg / 84.90 pounds

DIMENSIONS DES PANNEAUX SANS FEUILLURE
PANELS DIMENSIONS WITHOUT RABBET

FINITION / FINISHING

REFERENCE

EAN CODE

	NON MIROITÉ <i>NON MIRRORED</i>	CRISTAL INCOLORE - <i>CLEAR CRYSTAL</i>	1023800	
	A MIROITÉ <i>MIRRORED</i>	CRISTAL INCOLORE - <i>CLEAR CRYSTAL</i>	1023810	
	NON MIROITÉ <i>NON MIRRORED</i>	CRISTAL INCOLORE - <i>CLEAR CRYSTAL</i>	1023900	
	B MIROITÉ <i>MIRRORED</i>	CRISTAL INCOLORE - <i>CLEAR CRYSTAL</i>	1023910	
	NON MIROITÉ <i>NON MIRRORED</i>	CRISTAL INCOLORE - <i>CLEAR CRYSTAL</i>	1024000	
	C MIROITÉ <i>MIRRORED</i>	CRISTAL INCOLORE - <i>CLEAR CRYSTAL</i>	1024010	
	NON MIROITÉ <i>NON MIRRORED</i>	CRISTAL INCOLORE - <i>CLEAR CRYSTAL</i>	1024100	
	D MIROITÉ <i>MIRRORED</i>	CRISTAL INCOLORE - <i>CLEAR CRYSTAL</i>	1024110	
ENSEMBLE DE 4 PANNEAUX LAURIERS MIROITÉS* <i>4 LAURIERS MIRRORED PANELS*</i>			1024200	

1923 - René Lalique

Détails techniques et instructions de montage : cf fiche architecture. / *Technical datas & mounting instructions: see architecture files.*

*Livré avec monture, prêt à encadrer. Fixation sur face arrière du support. / **Delivered with frame to be fitted. To be fixed on back side of supporting material.*

PANNEAUX DÉCORATIFS - *DECORATIVE PANELS*

LES CAUSEUSES

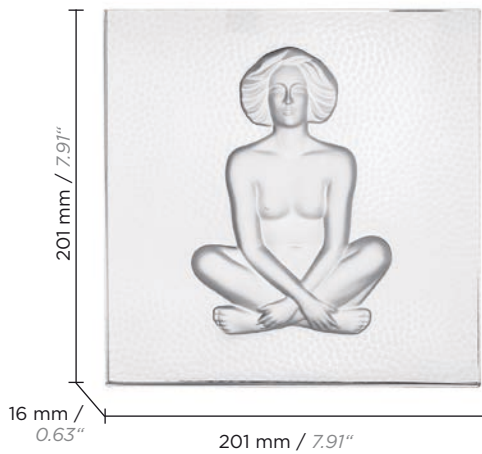

1,70 kg / 3.75 pounds

PM Face / SS front



PM Dos / SS back

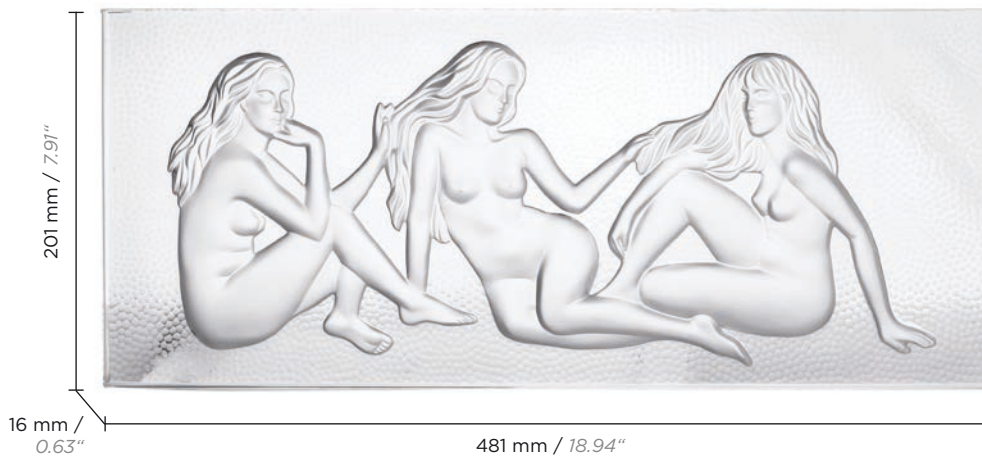

3,95 kg / 8.71 pounds

GM / LS

DIMENSIONS DES PANNEAUX SANS FEUILLURE
PANELS DIMENSIONS WITHOUT RABBET

FINITION / FINISHING

REFERENCE

EAN CODE



PM FACE NON MIROITÉ
SS FRONT, NON MIRRORED

CRISTAL INCOLORE
CLEAR CRYSTAL

1021401



PM DOS NON MIROITÉ
SS BACK, NON MIRRORED

CRISTAL INCOLORE
CLEAR CRYSTAL

1021402



GM NON MIROITÉ
LS, NON MIRRORED

CRISTAL INCOLORE
CLEAR CRYSTAL

1021501



2004 - LALIQUE

Détails techniques et instructions de montage : cf fiche architecture. / Technical datas & mounting instructions: see architecture files.

PANNEAUX DÉCORATIFS - *DECORATIVE PANELS*

MASQUE DE FEMME

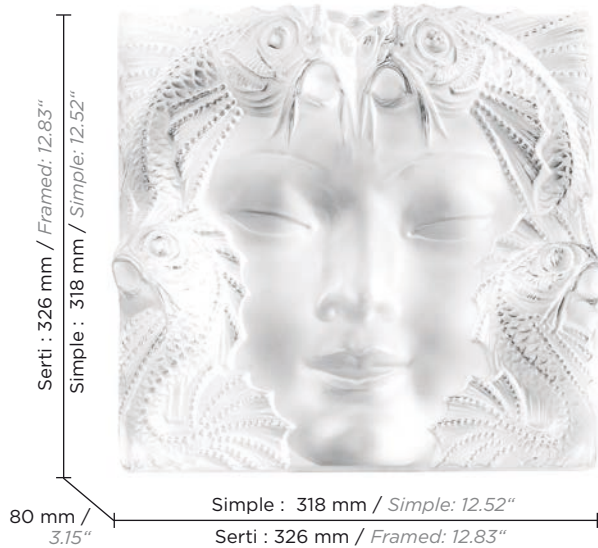

Simple : 13,50 kg / Simple: 29.76 pounds
Serti : 15,10 kg / Framed: 33.29 pounds

GM incolore / LS, clear

DIMENSIONS DES PANNEAUX SANS FEUILLURE
PANELS DIMENSIONS WITHOUT RABBET

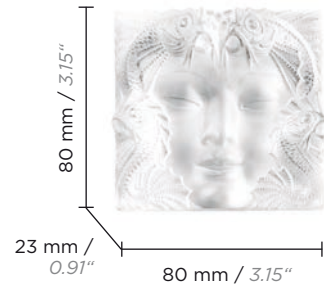

0,28 kg / 0.62 pounds
PM incolore / SS, clear

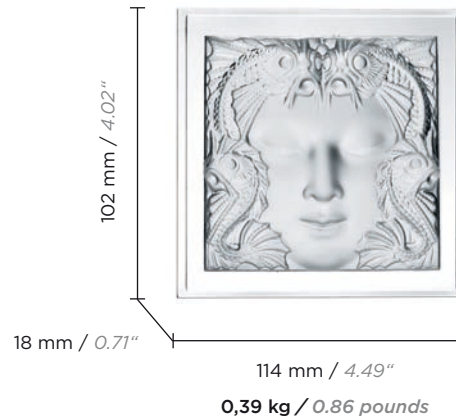

Révélation Masque de Femme

FINITION / FINISHING

REFERENCE

EAN CODE

PM - SS



NON MIROITÉ
NON MIRRORRED



CRISTAL INCOLORE
CLEAR CRYSTAL

10039700



MIROITÉ
MIRRORED



CRISTAL INCOLORE
CLEAR CRYSTAL

10039800



1935 - René Lalique

GM - LS



SIMPLE
SIMPLE



CRISTAL INCOLORE
CLEAR CRYSTAL

1164502



SERTI
FRAMED



CRISTAL INCOLORE
CLEAR CRYSTAL

1166500



GM SUR CHEVALET
LS WITH STAND



CRISTAL INCOLORE
CLEAR CRYSTAL

1164500



RÉVÉLATION MASQUE DE FEMME *REVELATION MASQUE DE FEMME*



NON MIROITÉ
NON MIRRORRED



CRISTAL INCOLORE
CLEAR CRYSTAL

10089000



1935 - René Lalique

Détails techniques et instructions de montage : cf fiche architecture. / *Technical datas & mounting instructions: see architecture files.*

PANNEAUX DÉCORATIFS - *DECORATIVE PANELS*

MERLES ET RAISINS



Tête Levée / *Head Up*



Tête Baissée / *Head Down*

DIMENSIONS DES PANNEAUX AVEC FEUILLURE
 PANELS DIMENSIONS WITH RABBET

FINITION / *FINISHING*

REFERENCE

EAN CODE

TÊTE LEVÉE - *HEAD UP*



NON MIROITÉ
NON MIRRORED



CRISTAL INCOLORE
 CLEAR CRYSTAL

10372500



MIROITÉ
MIRRORED



CRISTAL INCOLORE
 CLEAR CRYSTAL

10364200



TÊTE BAISSÉ - *HEAD DOWN*



NON MIROITÉ
NON MIRRORED



CRISTAL INCOLORE
 CLEAR CRYSTAL

10372600



MIROITÉ
MIRRORED



CRISTAL INCOLORE
 CLEAR CRYSTAL

10367200



1928 - René Lalique

Détails techniques et instructions de montage : cf fiche architecture. / *Technical datas & mounting instructions: see architecture files.*

MERLES ET RAISINS

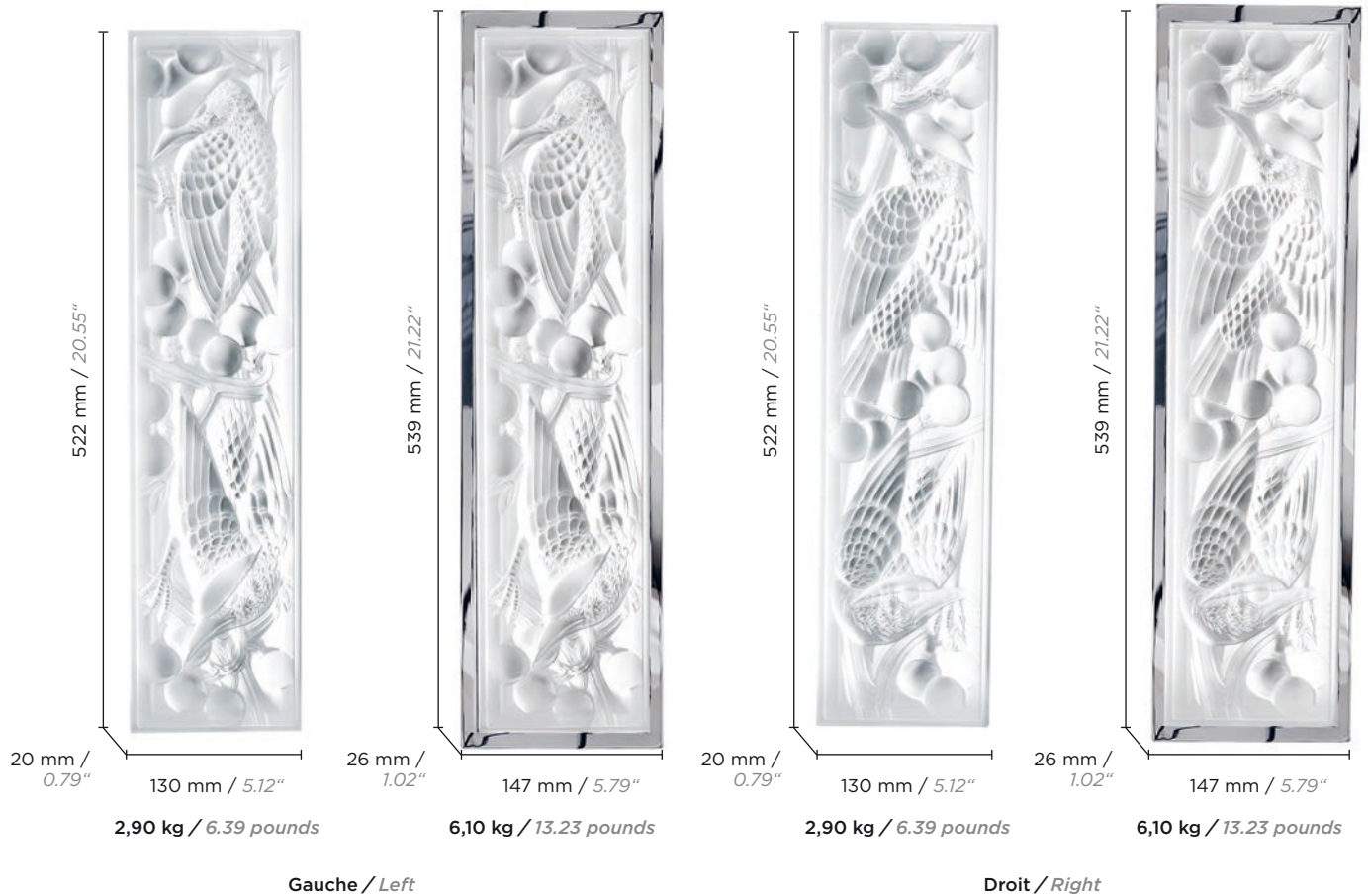

DIMENSIONS DES PANNEAUX AVEC FEUILLURE
PANELS DIMENSIONS WITH RABBET

FINITION / FINISHING		REFERENCE	EAN CODE
DROIT - RIGHT			
	NON MIROITÉ <i>NON MIRRORRED</i>	CRISTAL INCOLORE CLEAR CRYSTAL	1024900 0 90592 10249 7
	MIROITÉ <i>MIRRORRED</i>	CRISTAL INCOLORE CLEAR CRYSTAL	1024910 0 90592 09970 4
	MIROITÉ ENCADRÉ <i>MIRRORRED FRAMED</i>	CRISTAL INCOLORE CLEAR CRYSTAL	10625900 0 90592 89537 5
GAUCHE - LEFT			
	NON MIROITÉ <i>NON MIRRORRED</i>	CRISTAL INCOLORE CLEAR CRYSTAL	1024800 0 90592 10248 0
	MIROITÉ <i>MIRRORRED</i>	CRISTAL INCOLORE CLEAR CRYSTAL	1024810 0 90592 09969 8
	MIROITÉ ENCADRÉ <i>MIRRORRED FRAMED</i>	CRISTAL INCOLORE CLEAR CRYSTAL	10626000 0 90592 89536 8

1928 - René Lalique

Détails techniques et instructions de montage : cf fiche architecture. / *Technical datas & mounting instructions: see architecture files.*

PANNEAUX DÉCORATIFS - *DECORATIVE PANELS*

MERLES ET RAISINS

COMPOSITION / *ARRANGEMENT*

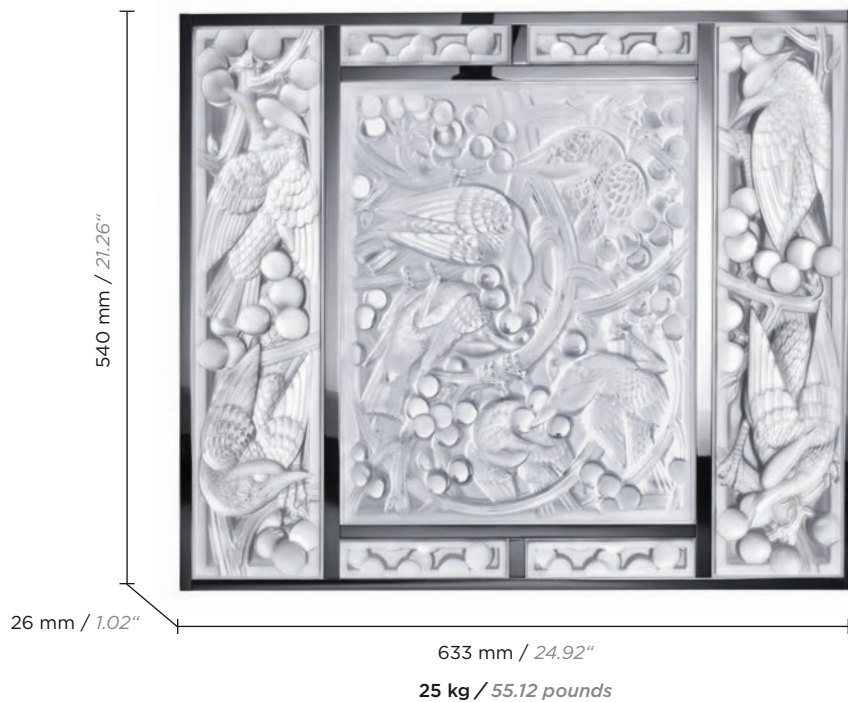

Composition Merles et Raisins Tête Levée miroité / *Merles et Raisins Head Up arrangement, mirrored*



Composition Merles et Raisins Tête Baissée miroité / *Merles et Raisins Head Down arrangement, mirrored*

DIMENSIONS DES PANNEAUX AVEC FEUILLURE
PANELS DIMENSIONS WITH RABBET

FINITION / *FINISHING*

REFERENCE

EAN CODE



TÊTE LEVÉE MIROITÉ - HEAD UP, MIRRORED
CRISTAL INCOLORE - *CLEAR CRYSTAL*
CHROMÉ - *CHROME*

10372900



TÊTE BAISSÉE MIROITÉ - HEAD DOWN, MIRRORED
CRISTAL INCOLORE - *CLEAR CRYSTAL*
CHROMÉ - *CHROME*

10372800



2014 - LALIQUE

Détails techniques et instructions de montage : cf fiche architecture. / *Technical datas & mounting instructions: see architecture files.*

PETITES BULLES



DIMENSIONS DES PANNEAUX AVEC FEUILLURE
 PANELS DIMENSIONS WITH RABBET

FINITION / FINISHING



NON MIROITÉ
NON MIRRORED

CRISTAL INCOLORE - *CLEAR CRYSTAL*

REFERENCE

10373200

EAN CODE



MIROITÉ
MIRRORED

CRISTAL INCOLORE - *CLEAR CRYSTAL*

10373100



2014 - LALIQUE

Détails techniques et instructions de montage : cf fiche architecture. / *Technical datas & mounting instructions: see architecture files.*

PANNEAUX DÉCORATIFS - *DECORATIVE PANELS*

RAISINS

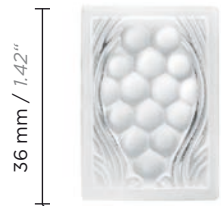

36 mm / 1.42"
8 mm / 0.31"
26 mm / 1.02"

0,02 kg / 0.04 pounds
PM / SS

DIMENSIONS DES PANNEAUX SANS FEUILLURE
PANELS DIMENSIONS WITHOUT RABBET



36 mm / 1.42"
8 mm / 0.31"
52 mm / 2.05"

0,04 kg / 0.09 pounds
SIMPLE



103 mm / 4.06"
0,08 kg / 0.18 pounds
DOUBLE



152 mm / 5.98"
0,12 kg / 0.26 pounds
TRIPLE

DIMENSIONS DES PANNEAUX SANS FEUILLURE
PANELS DIMENSIONS WITHOUT RABBET



118 mm / 4.65"
14 mm / 0.55"
152 mm / 5.98"

0,60 kg / 1.32 pounds

Gauche / Left



Centre / Center



Droit / Right

DIMENSIONS DES PANNEAUX AVEC FEUILLURE
PANELS DIMENSIONS WITH RABBET

FINITION / FINISHING		REFERENCE	EAN CODE
PM - SS			
	NON MIROITÉ NON MIRRORRED	 CRISTAL INCOLORE CLEAR CRYSTAL	1024600 
	MIROITÉ MIRRORED	 CRISTAL INCOLORE CLEAR CRYSTAL	1024610 
SIMPLE - SIMPLE			
	NON MIROITÉ NON MIRRORRED	 CRISTAL INCOLORE CLEAR CRYSTAL	1025200 
	MIROITÉ MIRRORED	 CRISTAL INCOLORE CLEAR CRYSTAL	1025210 
DOUBLE - DOUBLE			
	NON MIROITÉ NON MIRRORRED	 CRISTAL INCOLORE CLEAR CRYSTAL	1025100 
	MIROITÉ MIRRORED	 CRISTAL INCOLORE CLEAR CRYSTAL	1025110 
TRIPLE - TRIPLE			
	NON MIROITÉ NON MIRRORRED	 CRISTAL INCOLORE CLEAR CRYSTAL	1024700 
	MIROITÉ MIRRORED	 CRISTAL INCOLORE CLEAR CRYSTAL	1024710 
DROIT - RIGHT			
	NON MIROITÉ NON MIRRORRED	 CRISTAL INCOLORE CLEAR CRYSTAL	1022800 
	MIROITÉ MIRRORED	 CRISTAL INCOLORE CLEAR CRYSTAL	1022810 
GAUCHE - LEFT			
	NON MIROITÉ NON MIRRORRED	 CRISTAL INCOLORE CLEAR CRYSTAL	1022900 
	MIROITÉ MIRRORED	 CRISTAL INCOLORE CLEAR CRYSTAL	1022910 
CENTRE - CENTER			
	NON MIROITÉ NON MIRRORRED	 CRISTAL INCOLORE CLEAR CRYSTAL	1023000 
	MIROITÉ MIRRORED	 CRISTAL INCOLORE CLEAR CRYSTAL	1023010 

1928 - René Lalique

Détails techniques et instructions de montage : cf fiche architecture. / *Technical datas & mounting instructions: see architecture files.*

PANNEAUX DÉCORATIFS - *DECORATIVE PANELS*

ROSES



130 mm / 5.12"

60 mm / 2.36"

0,23 kg / 0.51 pounds

PM / MS

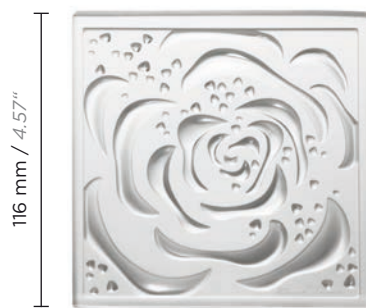

116 mm / 4.57"

116 mm / 4.57"

0,55 kg / 1.21 pounds

MM / SS



316 mm / 12.44"

116 mm / 4.57"

1,60 kg / 3.53 pounds

GM / LS

DIMENSIONS DES PANNEAUX AVEC FEUILLURE
PANELS DIMENSIONS WITH RABBET

FINITION / FINISHING

REFERENCE

EAN CODE

PM - SS



NON MIROITÉ
NON MİRRORED



CRISTAL INCOLORE
CLEAR CRYSTAL

10122600



MIROITÉ
MİRRORED



CRISTAL INCOLORE
CLEAR CRYSTAL

10122700



MM - MS



NON MIROITÉ
NON MİRRORED



CRISTAL INCOLORE
CLEAR CRYSTAL

10210200



MIROITÉ
MİRRORED



CRISTAL INCOLORE
CLEAR CRYSTAL

10210300



GM - LS



NON MIROITÉ
NON MİRRORED



CRISTAL INCOLORE
CLEAR CRYSTAL

10122200



MIROITÉ
MİRRORED



CRISTAL INCOLORE
CLEAR CRYSTAL

10122300



2011 - LALIQUE

Détails techniques et instructions de montage : cf fiche architecture. / *Technical datas & mounting instructions: see architecture files.*

PANNEAUX DÉCORATIFS - *DECORATIVE PANELS*

SOUDAN

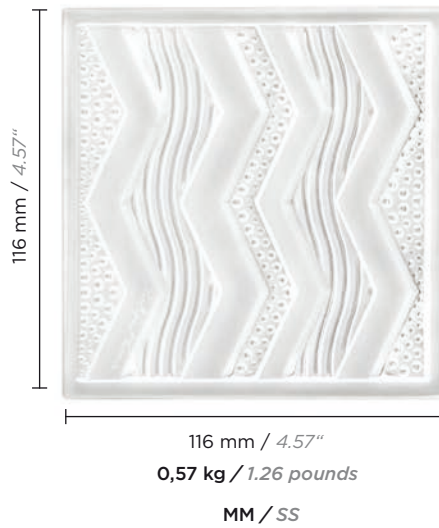
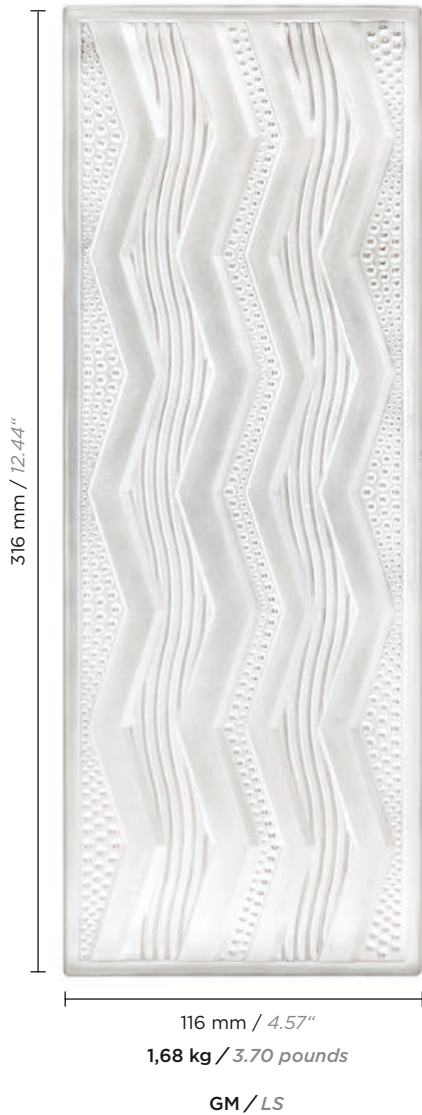

DIMENSIONS DES PANNEAUX AVEC FEUILLURE
PANELS DIMENSIONS WITH RABBET

FINITION / FINISHING

REFERENCE

EAN CODE

PM - SS



NON MIROITÉ
NON MIRRORRED



CRISTAL INCOLORE
CLEAR CRYSTAL

10122000



MIROITÉ
MIRRORED



CRISTAL INCOLORE
CLEAR CRYSTAL

10122100



MM - MS



NON MIROITÉ
NON MIRRORRED



CRISTAL INCOLORE
CLEAR CRYSTAL

10121800



MIROITÉ
MIRRORED



CRISTAL INCOLORE
CLEAR CRYSTAL

10121900



GM - LS



NON MIROITÉ
NON MIRRORRED



CRISTAL INCOLORE
CLEAR CRYSTAL

10121600



MIROITÉ
MIRRORED



CRISTAL INCOLORE
CLEAR CRYSTAL

10121700



2011 - LALIQUE

Détails techniques et instructions de montage : cf fiche architecture. / *Technical datas & mounting instructions: see architecture files.*

PANNEAUX DÉCORATIFS - *DECORATIVE PANELS*

VIBRATION

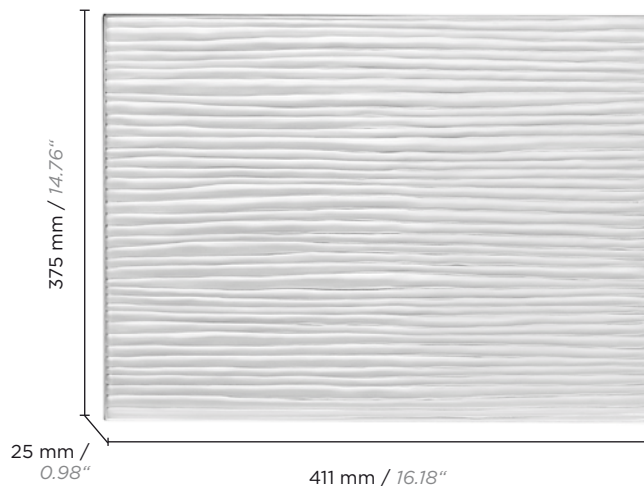

411 mm / 16.18"
7 kg / 15.43 pounds

Incolore / *Clear*



Lustré or / *Gold luster*

Photos non contractuelles / *Non contractual pictures*

DIMENSIONS DES PANNEAUX SANS FEUILLURE
PANELS DIMENSIONS WITHOUT RABBET

FINITION / *FINISHING*

REFERENCE

EAN CODE



NON MIROITÉ
NON MIRRORRED



CRISTAL INCOLORE
CLEAR CRYSTAL

10633300



MIROITÉ
MIRRORRED



CRISTAL INCOLORE
CLEAR CRYSTAL

10671000



NON MIROITÉ
NON MIRRORRED



CRISTAL INCOLORE
CLEAR CRYSTAL

10633400



MIROITÉ
MIRRORRED



CRISTAL LUSTRÉ OR
GOLD LUSTER CRYSTAL

10633500



2018 - LALIQUE

Détails techniques et instructions de montage : cf fiche architecture. / *Technical datas & mounting instructions: see architecture files.*

PANNEAUX DÉCORATIFS - *DECORATIVE PANELS*

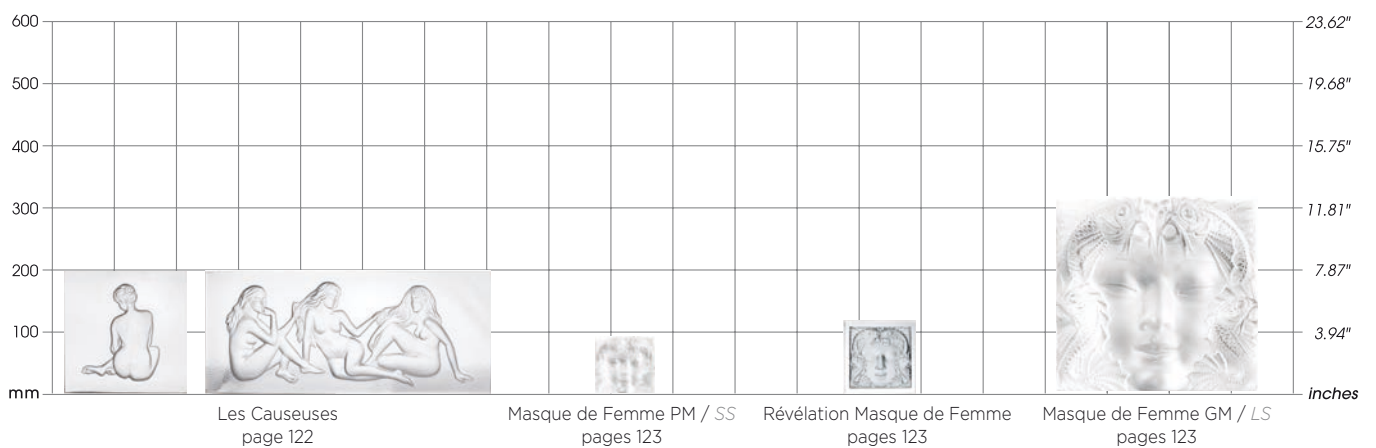
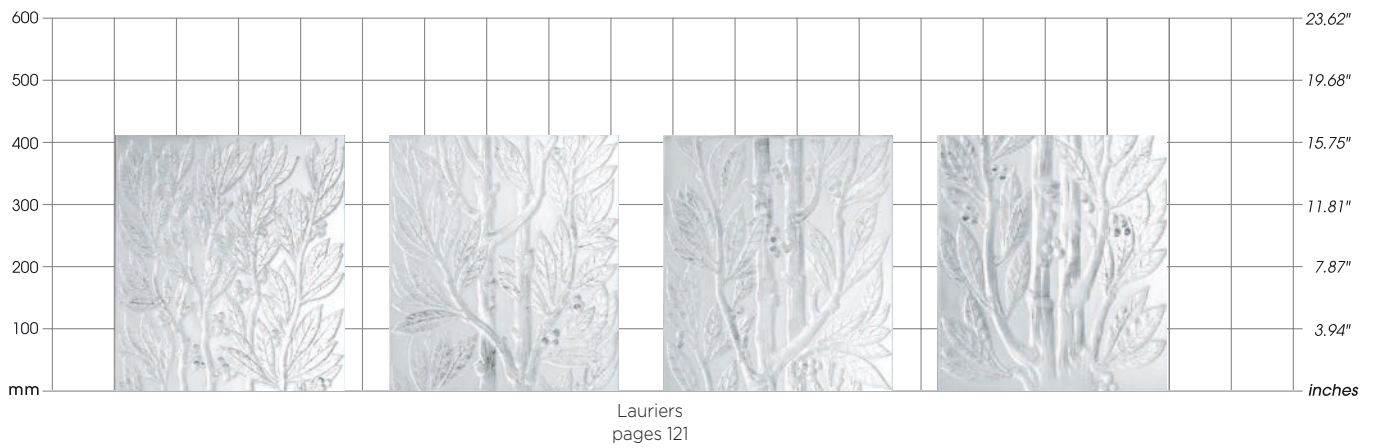
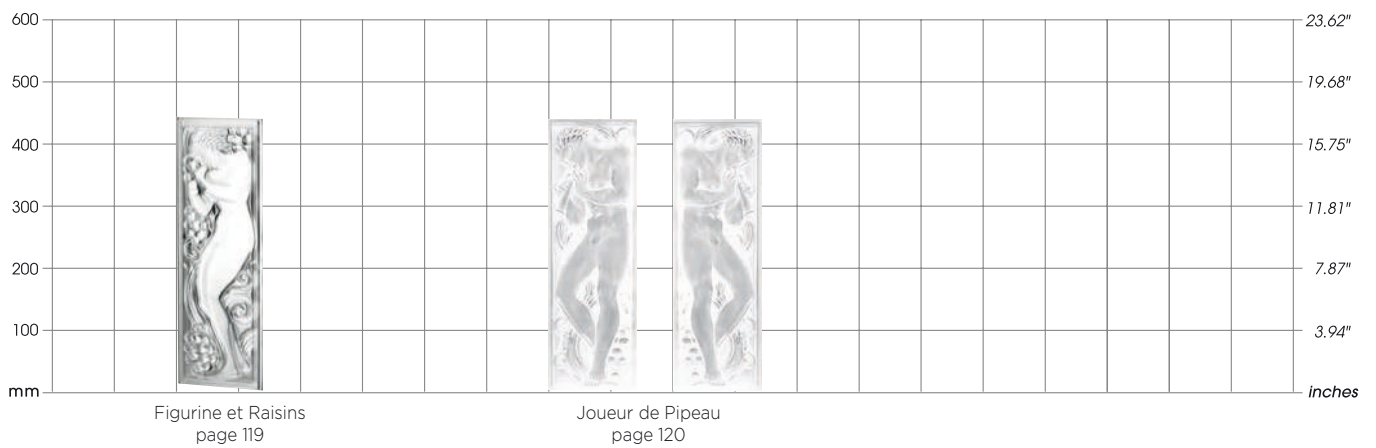
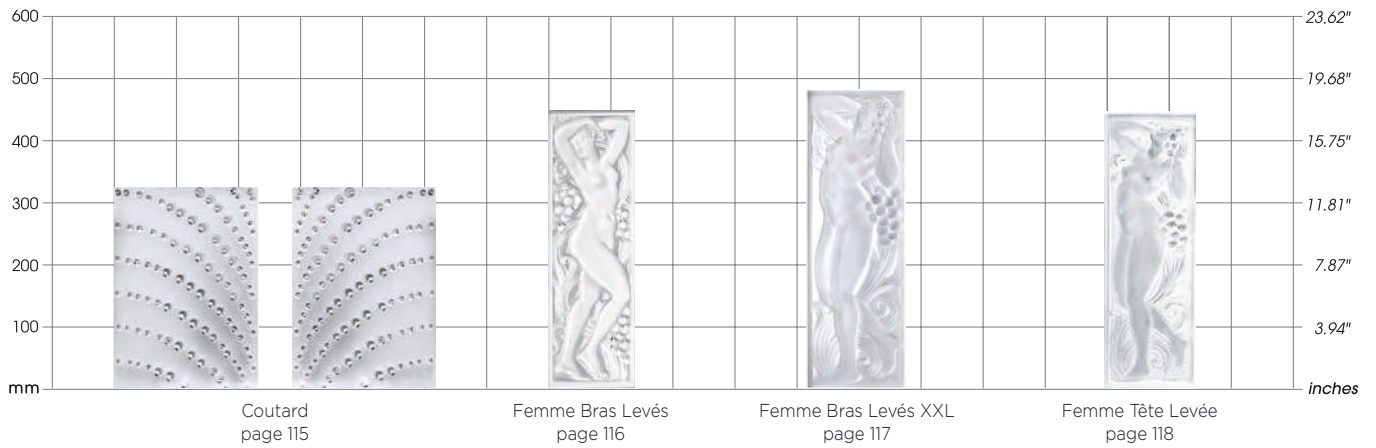

PANNEAUX DÉCORATIFS - *DECORATIVE PANELS*

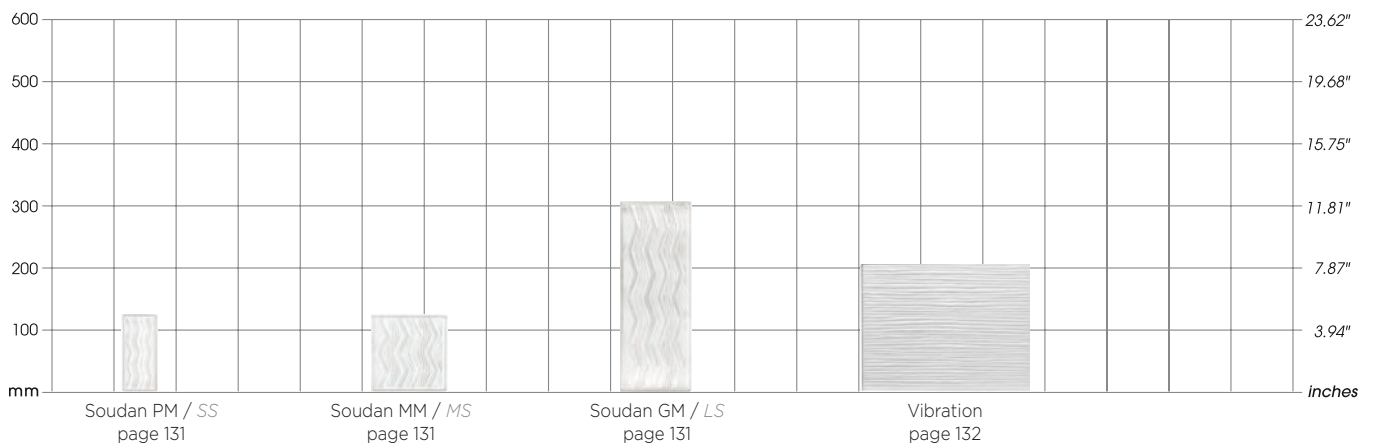
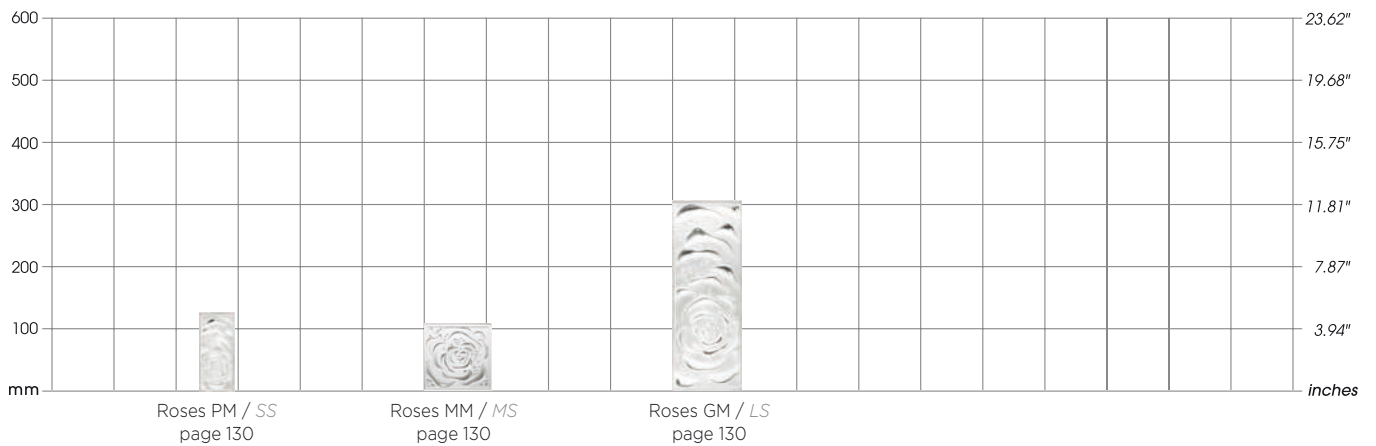
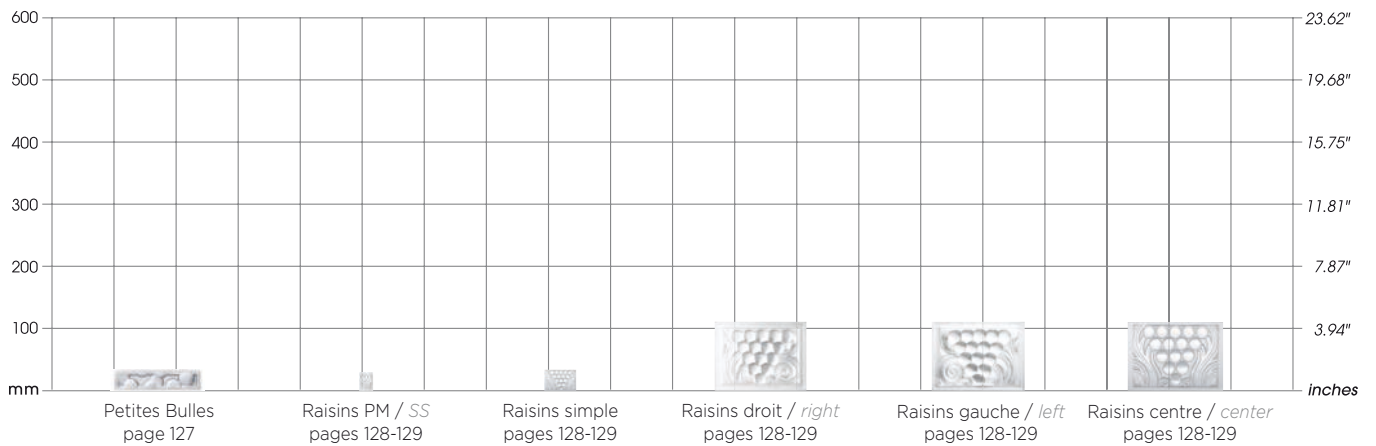
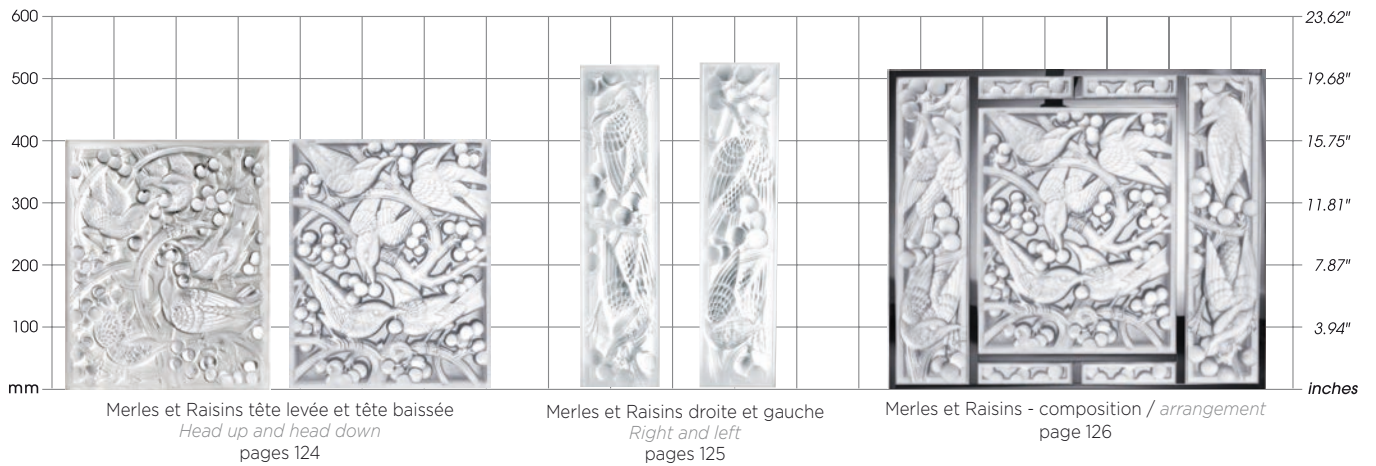

PANNEAUX D'ESPACE - INTERIOR PANELS

Panneaux de verre extra-blancs aux formats et dimensions sur-mesure contenant des éléments en cristal et/ou des motifs sablés à la main.

Extra-white bespoke glass panels with crystal elements and/or sand-blasted patterns applied by hand.



Image 3D - non contractuelle / 3D picture - non contractual

PANNEAUX D'ESPACE - *INTERIOR PANELS*

I. SUGGESTIONS D'INTÉGRATION / *SUGGESTIONS FOR INTEGRATION*

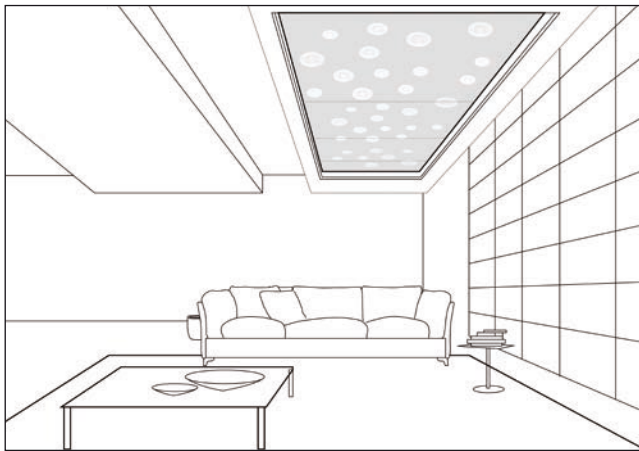

Inserts de plafond, 3 x Dahlia 900 x 900 mm
Ceiling inserts, 3 x Dahlia 35.43" x 35.43"



Paroi et miroir Dahlia, sur-mesure
Wall and mirror Dahlia, bespoke

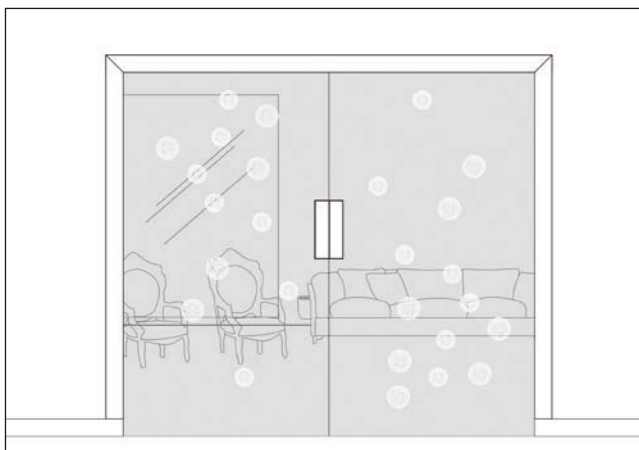

Double porte Dahlia, sur-mesure
Dahlia full door, bespoke

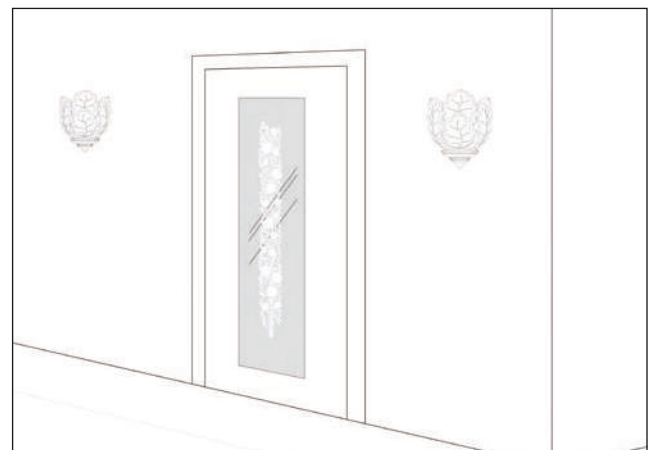

Insert de porte, 1 x Bouquet 1500 x 400 mm
Door insert, 1 x Bouquet 59.05" x 15.74"

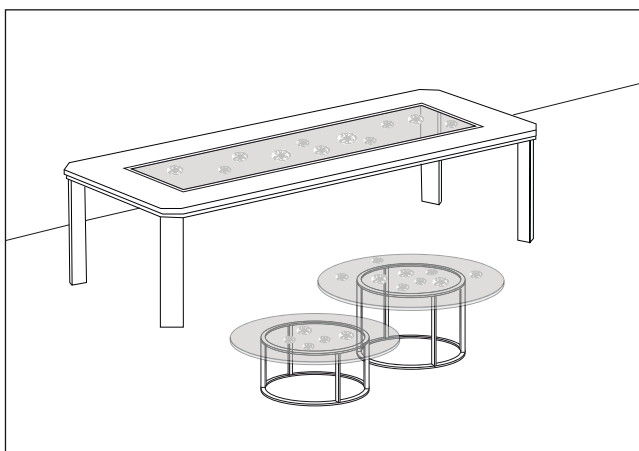

Plateau de table et tables basses Dahlia
(piétements non fournis par LALIQUÉ)
Dahlia table tops (table base non provided by LALIQUÉ)

PANNEAUX D'ESPACE - INTERIOR PANELS

II. FORMATS ET DIMENSIONS POSSIBLES / POSSIBLE FORMATS AND DIMENSIONS

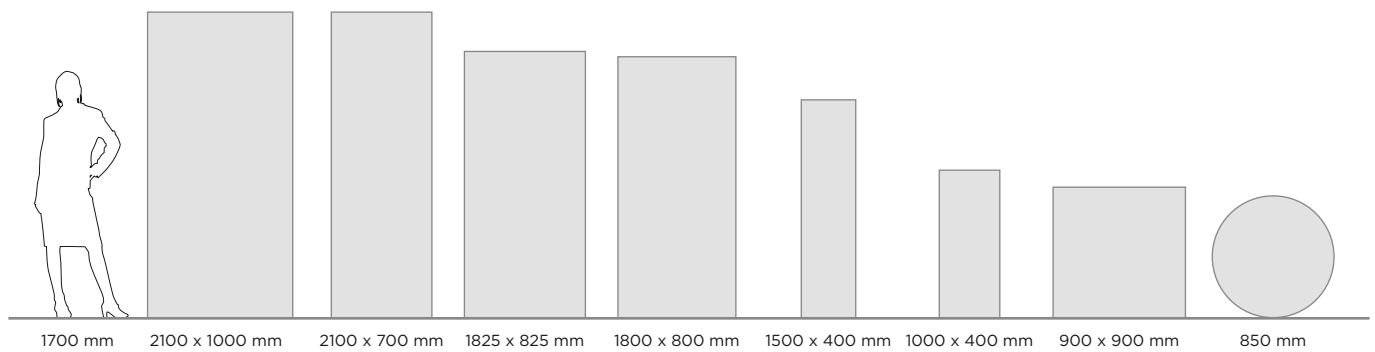

Dimensions et formats disponibles actuellement au catalogue LALIQUE. **À noter que tous les formats et toutes les dimensions sont réalisables sur-mesure à la demande du client après concertation avec Lalique Interior Design Studio.**

Available dimensions and formats in LALIQUE catalogue. **Please note that all formats and dimensions can be customized according to the client request after confirmation with the Lalique Interior Design Studio.**

CLAIR DE VUE (schéma de principe)

"INSIDE MEASUREMENT" (basic sketch)

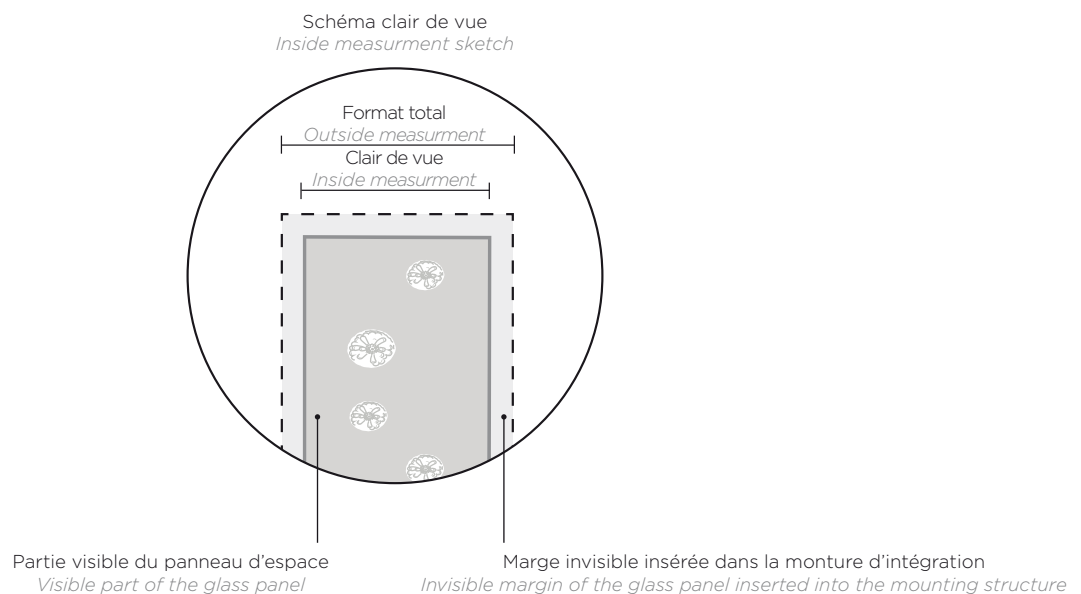

III. CHOIX DU MOTIF EN CRISTAL / CRYSTAL PATTERN OPTIONS



Bouquet



Dahlia



Languedoc



Venise

Le motif cristal peut être choisi parmi notre offre dans la catégorie panneau d'espace. Pour tout autre panneau décoratif, voir avec Lalique Interior Design Studio.

The crystal pattern can be chosen from our interior panels range. For any other decorative panel, please see with Lalique interior Design Studio.

IV. FINITIONS ESTHÉTIQUES DES PANNEAUX / PANELS AESTHETIC FINISHING

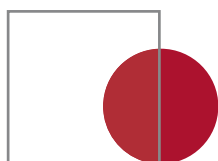

CLAIR / CLEAR
Panneau transparent
Transparent panel

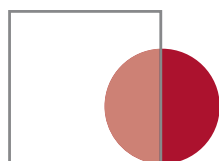

SATINÉ / SATIN
Panneau semi-transparent
Semi-transparent panel



SATINÉ-MIROITÉ / SATIN-MIRRORED
Panneau opaque
Opaque panel



MIROIR / MIRROR
Panneau réfléchissant
Reflective panel

V. FINITIONS TECHNIQUES DES PANNEAUX / PANELS TECHNICAL FINISHING

1 - SÉCURISATION DU VERRE :

Le type de sécurisation du verre est défini en fonction du lieu et du panneau sélectionné.

- VERRE TREMPÉ : Verre de sécurité traité pour être plus résistant qu'un verre normal.
- VERRE FEUILLETÉ : Verre de sécurité constitué d'au moins deux feuilles de verre séparées par un film intercalaire transparent. Les deux couches de verre sont visibles sur la tranche.
- VERRE FEUILLETÉ-TREMPÉ : Verre de sécurité composé d'une plaque de verre trempé et d'une plaque de verre standard, séparées par un film intercalaire transparent.

2 - OPTIONS DU VERRE :

- TRAITEMENT ANTI-CALCAIRE : revêtement protecteur contre le calcaire appliqué sur le côté lisse du panneau (sans élément cristal et / ou sablage).
- USINAGE : Possibilités de perçage pour fixer des charnières, poignées (non fournies par LALIQUÉ), ou de découpe du panneau en formes ovales, rondes...

1 - GLASS SECURITY:

The type of glass security is specified according to the location and the panel selection.

- TEMPERED GLASS: Security glass treated to be more resistant than a classic glass panel.
- LAYERED GLASS: Security glass made with at least two glass leaves and divided by an interlayer and transparent film. The two coated glass panels can be seen on the edge.
- LAYERED-TEMPERED GLASS: Security glass made with a tempered glass panel and classic glass panel divided by an interlayer and transparent film.

2 - GLASS OPTIONS:

- ANTI-SCALE TREATMENT: Anti-scale protective coating applied on the smooth side of the glass panel (without crystal element and / or sandblasting).
- MACHINING: Possibility of drilling, fixing handles (not provided by LALIQUÉ), or inserting round or oval shapes.

PANNEAUX D'ESPACE - INTERIOR PANELS

3 - TABLEAU DES FINITIONS ESTHÉTIQUES, TECHNIQUES ET OPTIONS POSSIBLES EN FONCTION DU MOTIF CRISTAL :

3 - AESTHETICAL, TECHNICAL AND OPTIONS FINISHING TABLE ACCORDING TO THE CRYSTAL PATTERN:

BOUQUET



Information données à titre indicatif, à confirmer en fonction du projet.

Data given for information, to be confirmed according to the project.

Finitions esthétiques possibles du panneau	Finitions techniques : sécurisation du verre			Options verre	
	Trempé	Feuilleté	Feuilleté Trempé	Traitement anti-calcaire	Usinages et découpes
Clair	non	oui	oui	oui	oui
Satiné	non	oui	oui	oui	oui
Satiné miroité	non	oui	oui	non	oui

Panel aesthetical	Technical finishes : Glass security			Glass option	
	Tempered	Layered	Layered tempered	Calcium deposit treatment	Machining and cutting
Clear	no	yes	yes	yes	yes
Satin	no	yes	yes	yes	yes
Satin mirrored	no	yes	yes	no	yes

DAHLIA

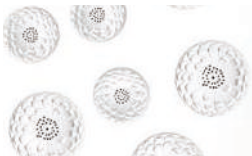

LANGUEDOC



Information données à titre indicatif, à confirmer en fonction du projet.

VENISE



Data given for information, to be confirmed according to the project.

Finitions esthétiques possibles du panneau	Finitions techniques : sécurisation du verre			Options verre	
	Trempé	Feuilleté	Feuilleté Trempé	Traitement anti-calcaire	Usinages et découpes
Clair	oui	oui	oui	oui	oui
Satiné	oui	oui	oui	oui	oui
Satiné miroité	non	oui	oui	non	oui
Miroir	non	oui	oui	non	oui

Panel aesthetical	Technical finishes : Glass security			Glass option	
	Tempered	Layered	Layered tempered	Calcium deposit treatment	Machining and cutting
Clear	yes	yes	yes	yes	yes
Satin	yes	yes	yes	yes	yes
Satin mirrored	no	yes	yes	no	yes
Mirrored	no	yes	yes	no	yes

INFORMATIONS INDISPENSABLES À PRÉCISER POUR TOUTE DEMANDE SUR MESURE :

Ces informations sont nécessaires pour la définition et l'étude de prix du panneau sur mesure.

- I. Environnement d'intégration du panneau et usage (paroi, miroir, insert de porte, etc.)
- II. Format, dimensions, épaisseur du panneau et clair de vue
- III. Choix du motif en cristal
- IV. Finition esthétique des panneaux
- V. Finition(s) technique(s) des panneaux : sécurisation, options du verre dont l'usinage (pour insert de charnières* et de poignées de porte*, etc.).
- VI. Information sur la mise en lumière* prévue du panneau

*Les systèmes lumineux, les montures, les charnières, les poignées de portes ou autres ne sont pas fournis par LALIQUE.

ESSENTIAL INFORMATION REQUIRED FOR ANY BESPOKE REQUEST:

The below information is required to develop the design study and provide a quotation.

- I. Integration environment and usage of the panel (wall, mirror, door insert, etc.)*
- II. Format, dimensions, thickness of the panel and "inside measurement"*
- III. Crystal pattern choice*
- IV. Panel aesthetic finishing*
- V. Panel technical finishing: glass security, options including machining (drilling* and handles* insert, etc.)*
- VI. Information on the required lighting* of the panel*

** Lighting systems, mountings, drillings and handles are not provided by LALIQUE.*

PANNEAUX D'ESPACE - INTERIOR PANELS

BOUQUET



1500 mm / 59.05"

400 mm / 15.74"

19 kg / 41.89 pounds



1800 mm / 70.86"

800 mm / 31.49"

45 kg / 99.21 pounds



2100 mm / 82.67"

1000 mm / 39.37"

67 kg / 147.71 pounds

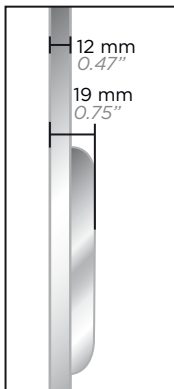

Épaisseur 12 mm - jusqu'à 19 mm
au niveau des fleurs de cristal
Thickness 0.47" - up to 0.75" for
the crystal flowers

FINITION / FINISHING

REFERENCE

EAN CODE

H1500 X L400MM
H59.05" X L15.74"

VERRE SATINÉ
SATIN FINISH GLASS



CRISTAL INCOLORE
CLEAR CRYSTAL

10302000



H1800 X L800MM
H70.86" X L31.49"

VERRE SATINÉ
SATIN FINISH GLASS



CRISTAL INCOLORE
CLEAR CRYSTAL

10302100



H2100 X L1000MM
H82.67" X L39.37"

VERRE SATINÉ
SATIN FINISH GLASS



CRISTAL INCOLORE
CLEAR CRYSTAL

10302200



2012 - LALIQUÉ

Détails techniques et instructions de montage : cf fiche architecture. / *Technical datas & mounting instructions: see architecture files.*
Autres formats sur demande (cf fiche architecture). / *Other dimensions on request (see architecture files).*

PANNEAUX D'ESPACE - INTERIOR PANELS

DAHLIA

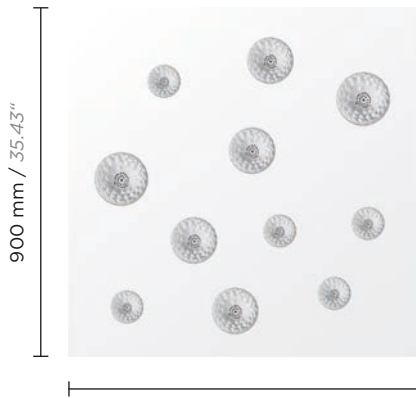

900 mm / 35.43"

900 mm / 35.43"

35 kg / 77.16 pounds

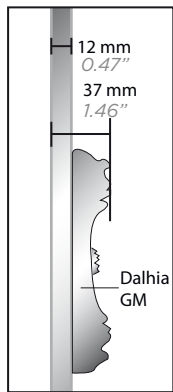

Épaisseur : 12 mm jusqu'à 37 mm
au niveau du plus grand Dahlia en cristal.
Thickness: 0.47" up to 1.46"
for the largest crystal Dahlia.

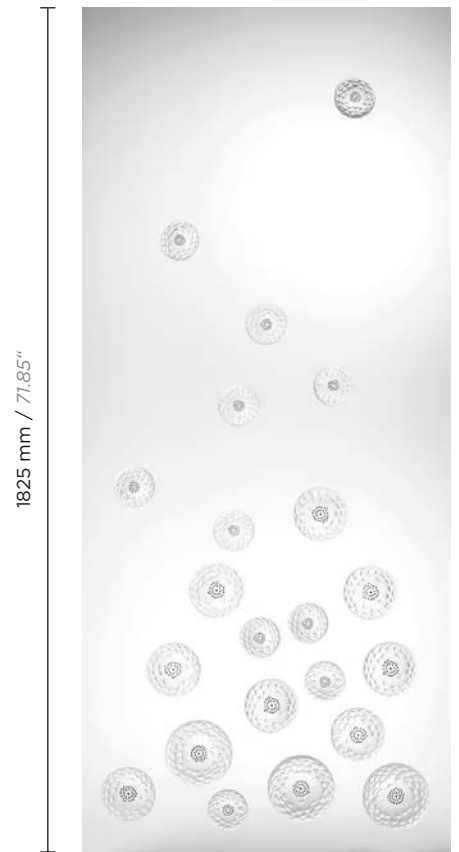

1825 mm / 71.85"

825 mm / 32.48"

47 kg / 103.62 pounds

FINITION / FINISHING

			REFERENCE	EAN CODE	
H900 x L900mm L35.43" x L35.43"	VERRE CLAIR CLEAR GLASS		CRISTAL INCOLORE CLEAR CRYSTAL	10318900	
	MIROIR MIRROR		CRISTAL INCOLORE CLEAR CRYSTAL	10318800	
	VERRE SATINÉ SATIN FINISH GLASS		CRISTAL INCOLORE CLEAR CRYSTAL	10302300	
	VERRE SATINÉ, MIROITÉ MIRRORED, SATIN FINISH GLASS		CRISTAL INCOLORE CLEAR CRYSTAL	10302400	
H1825 x L825 mm H71.85" x L32.48"	VERRE CLAIR CLEAR GLASS		CRISTAL INCOLORE CLEAR CRYSTAL	10368000	
	MIROIR MIRROR		CRISTAL INCOLORE CLEAR CRYSTAL	10367800	
	VERRE SATINÉ SATIN FINISH GLASS		CRISTAL INCOLORE CLEAR CRYSTAL	10367600	
	VERRE SATINÉ, MIROITÉ MIRRORED, SATIN FINISH GLASS		CRISTAL INCOLORE CLEAR CRYSTAL	10367700	

2012 - LALIQUE

Détails techniques et instructions de montage : cf fiche architecture. / Technical datas & mounting instructions: see architecture files.

Autres formats sur demande (cf fiche architecture). / Other dimensions on request (see architecture files).

PANNEAUX D'ESPACE - INTERIOR PANELS

LANGUEDOC

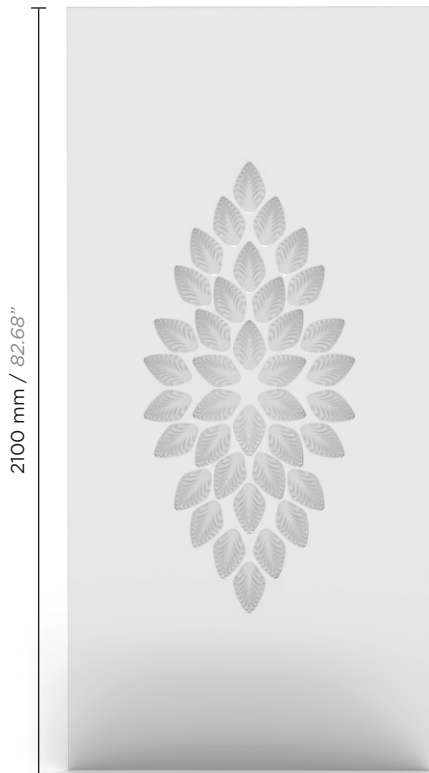

Panneau 2100 x 1000 mm - 38 cristaux
Panel 2100 x 1000 mm - 38 crystals

2100 mm / 82.68"

1000 mm / 39.37"

72 kg / 158.73 pounds

Panneau diam. 850 mm - 10 cristaux
Panel diam. 850 mm - 10 crystals



Ø 850 mm / 33.46"

20 kg / 44.09 pounds

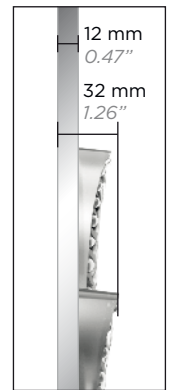

Épaisseur : 12 mm jusqu'à 32 mm
au niveau du cristal.
Thickness: 0.47" up to 1.26"
for the largest crystal part.



2100 mm / 82.68"

700 mm / 27.56"

49 kg / 108.03 pounds

Panneau 2100 x 700 mm - 22 cristaux
Présentation d'un panneau
Panel 2100 x 700 mm - 22 crystals
Presentation of one panel

Panneau 2100 x 700 mm
22 cristaux
Présentation de 2 panneaux
en porte double.
Commander 2 fois la même
référence, elles sont réversibles.
Panel 2100 x 700 mm
22 crystals
Presentation as a sliding door
with 2 panels.
Order twice the same reference,
there are reversible.



FINITION / FINISHING		REFERENCE	EAN CODE
2100 x 700 mm 82.68" x 27.56" 	VERRE CLAIR CLEAR GLASS	CRISTAL INCOLORE CLEAR CRYSTAL	10510300 
	VERRE MIROIR MIRROR GLASS	CRISTAL INCOLORE CLEAR CRYSTAL	10510400 
	VERRE SATINÉ SATIN FINISH GLASS	CRISTAL INCOLORE CLEAR CRYSTAL	10510500 
	VERRE SATINÉ MIROITÉ MIRRORED, SATIN FINISH GLASS	CRISTAL INCOLORE CLEAR CRYSTAL	10510600 
2100 x 1000 mm 82.68" x 39.37" 	VERRE CLAIR CLEAR GLASS	CRISTAL INCOLORE CLEAR CRYSTAL	10509900 
	VERRE MIROIR MIRROR GLASS	CRISTAL INCOLORE CLEAR CRYSTAL	10510000 
	VERRE SATINÉ SATIN FINISH GLASS	CRISTAL INCOLORE CLEAR CRYSTAL	10510100 
	VERRE SATINÉ MIROITÉ MIRRORED, SATIN FINISH GLASS	CRISTAL INCOLORE CLEAR CRYSTAL	10510200 
Ø 850 mm Ø 33.46" 	VERRE CLAIR CLEAR GLASS	CRISTAL INCOLORE CLEAR CRYSTAL	10509500 
	VERRE MIROIR MIRROR GLASS	CRISTAL INCOLORE CLEAR CRYSTAL	10509600 
	VERRE SATINÉ SATIN FINISH GLASS	CRISTAL INCOLORE CLEAR CRYSTAL	10509700 
	VERRE SATINÉ MIROITÉ MIRRORED, SATIN FINISH GLASS	CRISTAL INCOLORE CLEAR CRYSTAL	10509800 

2015 - LALIQUE

Détails techniques et instructions de montage : cf fiche architecture. / Technical datas & mounting instructions: see architecture files.

PANNEAUX D'ESPACE - INTERIOR PANELS

VENISE

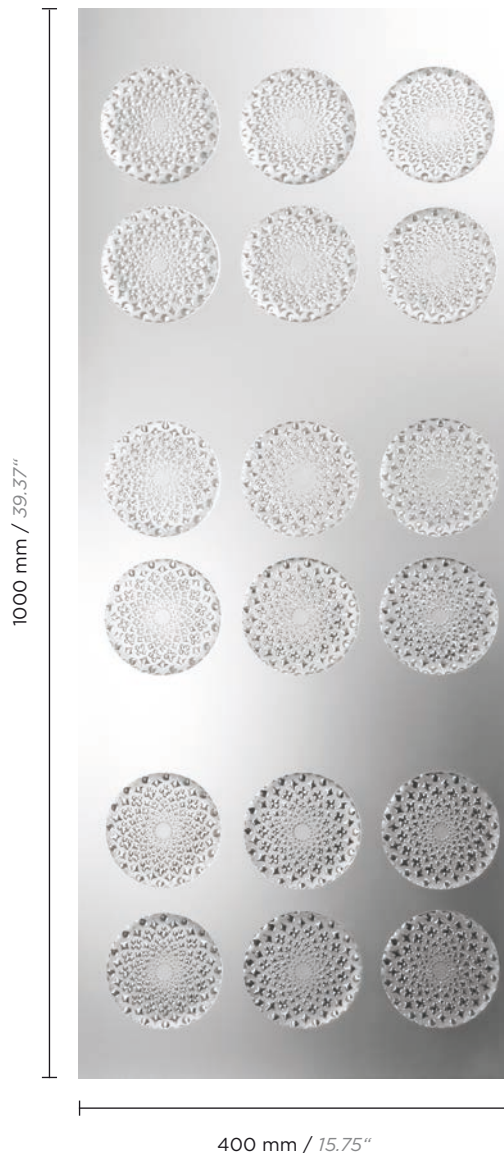

15 kg / 33.07 pounds

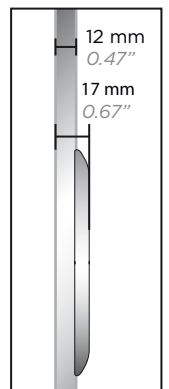

Épaisseur 12 mm - jusqu'à 17 mm
au niveau du cristal.
Thickness 0.47" - up to 0.67"
for the crystal tops.

FINITION / FINISHING			REFERENCE	EAN CODE
VERRE CLAIR CLEAR GLASS		CRISTAL INCOLORE CLEAR CRYSTAL	10368200	 0 90592 92265 1
MIROIR MIRROR		CRISTAL INCOLORE CLEAR CRYSTAL	10368100	 0 90592 92266 8
VERRE SATINÉ SATIN FINISH GLASS		CRISTAL INCOLORE CLEAR CRYSTAL	10319800	 0 90592 92769 4
VERRE SATINÉ, MIROITÉ MIRRORED, SATIN FINISH GLASS		CRISTAL INCOLORE CLEAR CRYSTAL	10319900	 0 90592 92768 7

2013 - LALIQUÉ

Détails techniques et instructions de montage : cf fiche architecture. / Technical datas & mounting instructions: see architecture files.
Autres formats sur demande (cf fiche architecture). / Other dimensions on request (see architecture files).W

BOUQUET











FINITION / FINISHING

		REFERENCE	EAN CODE
H170 x L170 x E37 mm <i>H6.69" x L6.69" x W1.46"</i>	VERRE CLAIR <i>CLEAR GLASS</i>	 CRISTAL INCOLORE <i>CLEAR CRYSTAL</i>	10482300 
	MIROIR <i>MIRROR</i>	 CRISTAL INCOLORE <i>CLEAR CRYSTAL</i>	10482400 
	VERRE SATINÉ <i>SATIN FINISH GLASS</i>	 CRISTAL INCOLORE <i>CLEAR CRYSTAL</i>	10482100 
	VERRE SATINÉ, MIROITÉ <i>MIRRORED, SATIN FINISH GLASS</i>	 CRISTAL INCOLORE <i>CLEAR CRYSTAL</i>	10482200 

DAHLIA



FINITION / FINISHING

		REFERENCE	EAN CODE
H170 x L170 x E37 mm <i>H6.69" x L6.69" x W1.46"</i>	VERRE CLAIR <i>CLEAR GLASS</i>	 CRISTAL INCOLORE <i>CLEAR CRYSTAL</i>	10481300 
	MIROIR <i>MIRROR</i>	 CRISTAL INCOLORE <i>CLEAR CRYSTAL</i>	10481400 
	VERRE SATINÉ <i>SATIN FINISH GLASS</i>	 CRISTAL INCOLORE <i>CLEAR CRYSTAL</i>	10360300 
	VERRE SATINÉ, MIROITÉ <i>MIRRORED, SATIN FINISH GLASS</i>	 CRISTAL INCOLORE <i>CLEAR CRYSTAL</i>	10360400 

ÉCHANTILLONS - SAMPLES

LANGUEDOC



FINITION / FINISHING

			REFERENCE	EAN CODE
H170 x L170 x E37 mm <i>H6.69" x L6.69" x W1.46"</i>	VERRE CLAIR CLEAR GLASS		CRISTAL INCOLORE CLEAR CRYSTAL 10510700	 0 90592 90771 9
	MIROIR MIRROR		CRISTAL INCOLORE CLEAR CRYSTAL 10510800	 0 90592 90770 2
	VERRE SATINÉ SATIN FINISH GLASS		CRISTAL INCOLORE CLEAR CRYSTAL 10510900	 0 90592 90769 6
	VERRE SATINÉ, MIROITÉ MIRRORED, SATIN FINISH GLASS		CRISTAL INCOLORE CLEAR CRYSTAL 10511000	 0 90592 90768 9

VENISE



FINITION / FINISHING

			REFERENCE	EAN CODE
H170 x L170 x E37 mm <i>H6.69" x L6.69" x W1.46"</i>	VERRE CLAIR CLEAR GLASS		CRISTAL INCOLORE CLEAR CRYSTAL 10360500	 0 90592 92346 7
	MIROIR MIRROR		CRISTAL INCOLORE CLEAR CRYSTAL 10360600	 0 90592 92345 0
	VERRE SATINÉ SATIN FINISH GLASS		CRISTAL INCOLORE CLEAR CRYSTAL 10481700	 0 90592 91075 7
	VERRE SATINÉ, MIROITÉ MIRRORED, SATIN FINISH GLASS		CRISTAL INCOLORE CLEAR CRYSTAL 10481800	 0 90592 91074 0

LALIQUE

MAISON



Tout a commencé avec Lalique il y a plus d'une dizaine d'années quand nous avons travaillé sur le yacht d'un client passionné d'Art Déco. Nous nous sommes immergés dans cette période et particulièrement dans les créations de René Lalique pour en comprendre l'esprit. Un challenge passionnant car il s'agissait d'intégrer harmonieusement le cristal Lalique dans du mobilier, des lampes et d'utiliser des vases et autres pièces en cristal aussi bien dans la chambre que dans le bar ou la salle de bain tout en exprimant notre expertise. Nous collaborons avec les meilleurs constructeurs de yachts italiens, ce sont des artisans parmi les plus exigeants en matière de finitions. Puis nous avons installé des pièces Lalique dans différents appartements et villas mais c'est notre travail sur un yacht de 65 mètres qui a attiré l'attention de Silvio Denz. Il y a trois ans et demi, nous avons commencé par dessiner des lampes, une crédence et quelques coussins, et aujourd'hui nous créons des pièces uniques. Nous avons réalisé en trois ans ce que nous aurions fait en dix normalement, presque quatre cents pièces au total, c'est incroyable. Au-delà d'être une collection de meubles, lampes, serviettes et linge de lit, Lalique Maison s'impose comme un style de vie. Cette collection puissante doit vivre avec la lumière. Les connaisseurs reconnaîtront immédiatement la touche unique. Il reste essentiel pour nous que chaque création trouve sa place dans le décor pour que l'un et l'autre se fassent écho.

Lalique s'inscrit désormais dans notre ADN, nous avons complètement assimilé ce savoir-faire dans nos projets. C'est une passion que nous déclinons au quotidien, jour après jour. Lorsque nous voyageons, toute chose peut devenir matière à réflexion, source d'inspiration, car nous savons jouer avec le cristal et transformer un dessin en prototype. C'est en permanence un « work in progress ».

It all began with Lalique over a dozen years ago, when we worked on the yacht belonging to a client passionate about Art Deco. We immersed ourselves in this period – especially René Lalique's designs – to understand its spirit. It was an exciting challenge because it involved harmoniously incorporating the Lalique crystal pieces into the furniture, lamps and using also vases and others crystal pieces into the bedroom as well as into the bar or the bathroom, while expressing our expertise. We collaborate with the best Italian yacht builders, who are some of the most demanding craftsmen when it comes to finishes. We subsequently placed Lalique pieces in different apartments, villas, but it was our work on a 65 meter yacht that caught Silvio Denz's attention. Three and a half years ago, we started designing lamps, a credenza and some cushions, and we now have a collection of unique creations. In three years, we have achieved what would normally have taken us ten years, we created nearly four hundred pieces; it's incredible. Over and above being a collection of furniture, lamps, towels and bed linen, Lalique Maison embodies a lifestyle. This powerful collection interplays with light. Connoisseurs will immediately recognise the unique touch. For us, it remains essential that each piece finds its place in the decor to their mutual benefit.

Lalique is now part of our DNA, we have completely assimilated this know-how into our upcoming projects. It's a passion that we express on a daily basis, day after day. When we travel, anything can become a source of inspiration because we know how to play with the crystal and transform a design into a prototype. It's a constant work in progress.

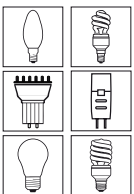

Ampoule fluorescente, halogène
et LED E12 - E14 - E26 - E27 - G9 - G4 /
*Fluorescent, halogène and LED
bulb E12 - E14 - E26 - E27 - G9 - G4*

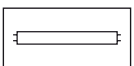

Tube fluorescent / *Fluorescent tube*



Disques, bandes de LEDs /
LED disks, strips

EU

Branchement Europe /
Europe plug

US

Branchement USA /
USA plug

UK

Branchement Royaume-Uni /
United Kingdom plug

CE

Certifié norme CE (230V Europe) /
Certified CE standard (230V Europe)

UL

Certifié norme UL (120V US) /
Certified UL standard (120V US)

IP20

Ce produit est conçu pour une utilisation intérieur. Il n'est pas destiné à être installé dans une salle de bain ou dans des locaux humides. Le luminaire ne doit pas entrer en contact avec l'eau. /

IP30

This product is designed for internal use. It is not intended to be installed in a bathroom or other damp premises. The light-fitting must not be in contact with water.



La finition « chromée » correspond dans le catalogue à un rendu argenté.
The "chrome" finishing in the catalogue corresponds to a silver rendering.

LUMINAIRES - *LIGHTINGS*



FEMME BRAS LEVÉS

ÉDITION NUMÉROTÉE / NUMBERED EDITION

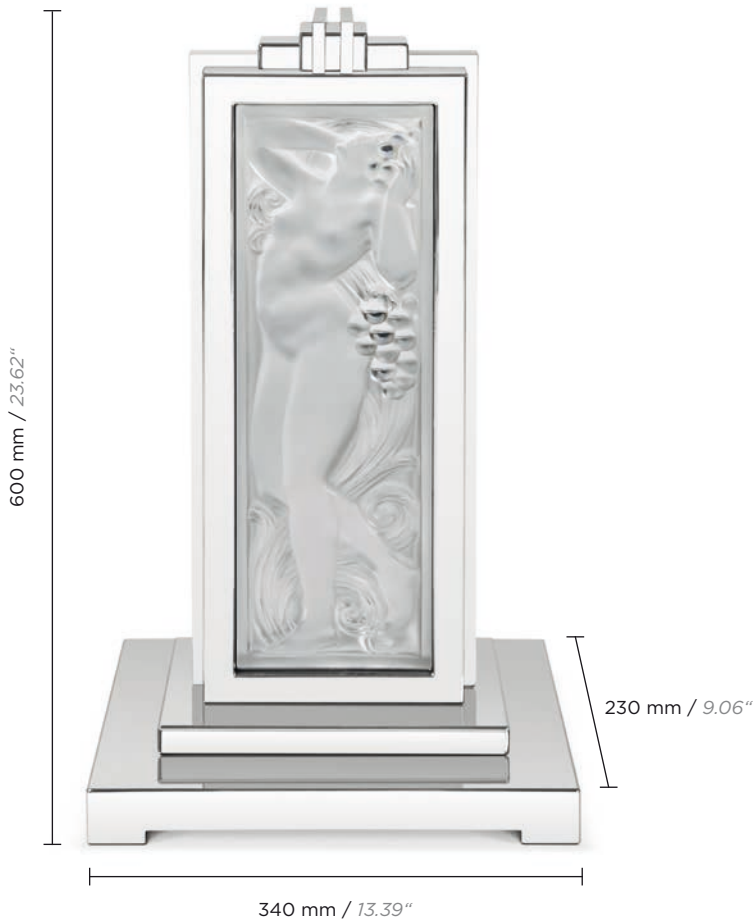







14 kg / 30.90 pounds

Incolore / Clear
Acier poli / Polished steel









Incolore et chromé / Clear and chrome
Acier poli / Polished steel

FINITION / FINISHING

	REFERENCE	EAN CODE
	EUROPE 10156500	 7 640111 494430
	US 10156600	 7 640111 494447
	UK 10156700	 7 640111 494454

2011 - LADY TINA GREEN & PIETRO MINGARELLI POUR LALIQUE

	EUROPE 10156712	 7 640111 508434
	US 10156711	 7 640111 508427
	UK 10156710	 7 640111 506669

2013 - LADY TINA GREEN & PIETRO MINGARELLI POUR LALIQUE



LED x 364 - 18 watts - 2160 lumens

CE IP20

4000°K - Lumière froide - Warm light

JOUEUR DE PIPEAU

ÉDITION NUMÉROTÉE / *NUMBERED EDITION*



FINITION / *FINISHING*

REFERENCE

EAN CODE



CRISTAL INCOLORE - *CLEAR CRYSTAL*
ACIER POLI - *POLISHED STEEL*

EUROPE
10157100



CRISTAL INCOLORE - *CLEAR CRYSTAL*
ACIER POLI - *POLISHED STEEL*

US
10157200



CRISTAL INCOLORE - *CLEAR CRYSTAL*
ACIER POLI - *POLISHED STEEL*

UK
10161500



LED x 364 - 18 watts - 2160 lumens

CE IP20

4000°K - Lumière froide - *Warm light*

MERLES ET RAISINS

ÉDITION NUMÉROTÉE / NUMBERED EDITION



FINITION / FINISHING



CRISTAL INCOLORE - CLEAR CRYSTAL
ACIER POLI - POLISHED STEEL



CRISTAL INCOLORE - CLEAR CRYSTAL
ACIER POLI - POLISHED STEEL

CRISTAL INCOLORE - CLEAR CRYSTAL
ACIER POLI - POLISHED STEEL

REFERENCE

EUROPE
10156800

US
10156900

UK
10157000

EAN CODE



LED x 364 - 21 watts - 2500 lumens



4000°K - Lumière froide - Warm light

2011 - LADY TINA GREEN & PIETRO MINGARELLI POUR LALIQUE

RAISINS PM / SS

ÉDITION NUMÉROTÉE / NUMBERED EDITION

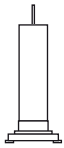

LAMPE HORS ABAT-JOUR

Hauteur x Longueur x Largeur - Poids :
590 x 270 x 170 mm - 10,5 kg

LAMP WITHOUT LAMPSHADE

Height x Length x Width - Weight:
23.23" x 10.63" x 6.69" - 23.15 pounds

FINITION / FINISHING



CRISTAL INCOLORE - CLEAR CRYSTAL
ACIER POLI - POLISHED STEEL

CRISTAL INCOLORE - CLEAR CRYSTAL
ACIER POLI - POLISHED STEEL

CRISTAL INCOLORE - CLEAR CRYSTAL
ACIER POLI - POLISHED STEEL

REFERENCE

EUROPE
10156200

US
10156300

UK
10156400

EAN CODE



E26-E27 x 2 - max 40watts



IP20



Lampe livrée sans abat-jour. / Lamp delivered without lampshade.

2011 - LADY TINA GREEN & PIETRO MINGARELLI POUR LALIQUE



ABAT-JOUR

Hauteur x Diamètre - Poids :
300 x 550 mm - 0,5 kg

LAMPSHADE

Height x Diameter - Weight:
11.81" x 21.65" - 1.1 pounds

FINITION / FINISHING

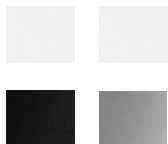

SOIE IVOIRE / INTÉRIEUR IVOIRE
IVORY SILK / INSIDE IVORY

SOIE NOIRE / INTÉRIEUR ARGENT
BLACK SILK / INSIDE SILVER

REFERENCE

10161800

10161900

EAN CODE



2011 - LADY TINA GREEN & PIETRO MINGARELLI POUR LALIQUE

RAISINS PM / SS

360 mm / 214.17"

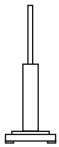

LAMPE HORS ABAT-JOUR

Hauteur x Longueur x Largeur - Poids
630 x 240 x 240 mm - 10 kg

LAMP WITHOUT LAMPSHADE

Height x Length x Width - Weight:
24.80" x 9.44" x 9.44" - 22.05 pounds

FINITION / FINISHING

REFERENCE

EAN CODE



CRISTAL INCOLORE - CLEAR CRYSTAL
CHROMÉ - CHROME

EUROPE
76111110



CRISTAL INCOLORE - CLEAR CRYSTAL
CHROMÉ - CHROME

US
76121110



CRISTAL INCOLORE - CLEAR CRYSTAL
CHROMÉ - CHROME

UK
76131110



E26-E27 x 2 - max 40 watts

CE IP20

Lampe livrée sans abat-jour. / Lamp delivered without lampshade.

2017 - LADY TINA GREEN & PIETRO MINGARELLI POUR LALIQUE

Détails techniques et instructions de montage : cf fiche architecture. / Technical datas & mounting instructions: see architecture files.

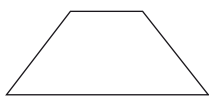

ABAT-JOUR

Hauteur x Longueur x Largeur - Poids :
160 x 360 x 360 mm

LAMPSHADE

Height x Length x Width - Weight:
6.29" x 14.17" x 14.17"

FINITION / FINISHING

REFERENCE

EAN CODE



SOIE IVOIRE / INTÉRIEUR IVOIRE
IVORY SILK / INSIDE IVORY

76300890



2006 - LALIQUE

RAISINS
PM / SS

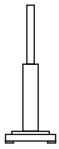

LAMPE HORS ABAT-JOUR

Hauteur x Longueur x Largeur - Poids
630 x 240 x 240 mm - 10 kg

LAMP WITHOUT LAMPSHADE

Height x Length x Width - Weight:
24.80" x 9.44" x 9.44" - 22.05 pounds

FINITION / FINISHING

REFERENCE

EAN CODE



CRISTAL LUSTRÉ OR - GOLD LUSTER CRYSTAL
FINITION SATINÉE DORÉE - GOLDEN SATIN FINISHING

EUROPE
76111120



CRISTAL LUSTRÉ OR - GOLD LUSTER CRYSTAL
FINITION SATINÉE DORÉE - GOLDEN SATIN FINISHING

US
76121120



CRISTAL LUSTRÉ OR - GOLD LUSTER CRYSTAL
FINITION SATINÉE DORÉE - GOLDEN SATIN FINISHING

UK
76131120



E26-E27 - 2 x 40 watts **CE IP20**

Lampe livrée sans abat-jour. / Lamp delivered without lampshade.

2018 - LADY TINA GREEN & PIETRO MINGARELLI POUR LALIQUE

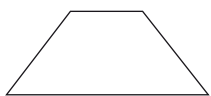

ABAT-JOUR

Hauteur x Longueur x Largeur :
160 x 360 x 360 mm

LAMPSHADE

Height x Length x Width :
6.29" x 14.17" x 14.17"

FINITION / FINISHING

REFERENCE

EAN CODE



SOIE IVOIRE / INTÉRIEUR IVOIRE
IVORY SILK / INSIDE IVORY

76300890



2006 - LALIQUE

RAISINS

GM / LS

ÉDITION NUMÉROTÉE / NUMBERED EDITION

Ø 700 mm / 27.56"



300 mm / 11.81"



300 mm / 11.81"

17 kg / 37.47 pounds



LAMPE HORS ABAT-JOUR

Hauteur x Longueur x Largeur :
654 x 300 x 300 mm

LAMP WITHOUT LAMPSHADE

Height x Length x Width:
25.75" x 11.81" x 11.81"

FINITION / FINISHING

REFERENCE

EAN CODE



CRISTAL INCOLORE - CLEAR CRYSTAL
ACIER POLI - POLISHED STEEL

EUROPE
10155900



CRISTAL INCOLORE - CLEAR CRYSTAL
ACIER POLI - POLISHED STEEL

US
10156000



CRISTAL INCOLORE - CLEAR CRYSTAL
ACIER POLI - POLISHED STEEL

UK
10156100



E26-E27 x 2 - max 40 watts



Lampe livrée sans abat-jour. / Lamp delivered without lampshade.

2011 - LADY TINA GREEN & PIETRO MINGARELLI POUR LALIQUE



ABAT-JOUR

Hauteur x Diamètre :
311 x 700 mm

LAMPSHADE

Height x Diameter:
12.24" x 27.56"

FINITION / FINISHING

REFERENCE

EAN CODE



SOIE IVOIRE / INTÉRIEUR IVOIRE
IVORY SILK / INSIDE IVORY

10161600



SOIE NOIRE / INTÉRIEUR ARGENT
BLACK SILK / INSIDE SILVER

10161700



2011 - LADY TINA GREEN & PIETRO MINGARELLI POUR LALIQUE

TABLES & MEUBLES DE RANGEMENT
TABLES & CABINETS



FEMME BRAS LEVÉS AVEC TRINGLE DE VÊTEMENTS / WITH CLOTHES RAIL

ÉDITION NUMÉROTÉE / NUMBERED EDITION



Dimensions incluant les poignées en cristal. /
Dimensions including the crystal handles.

263 kg / 579.80 pounds

FINITION / FINISHING

REFERENCE

EAN CODE



CRISTAL INCOLORE - CLEAR CRYSTAL
NOYER - WALNUT
ACIER DORÉ - INOX GOLDEN SATIN STEEL

72585003



7 640163 974621

2015 - LADY TINA GREEN & PIETRO MINGARELLI POUR LALIQUE

ARMOIRES - CABINETS

MERLES & RAISINS AVEC ÉTAGÈRES EN VERRE / WITH GLASS SHELVES ÉDITION NUMÉROTÉE / NUMBERED EDITION



Dimensions incluant les poignées en cristal. /
Dimensions including the crystal handles.

263 kg / 579.80 pounds

FINITION / FINISHING

REFERENCE

EAN CODE



CRISTAL INCOLORE - CLEAR CRYSTAL
NOYER - WALNUT
ACIER DORÉ - INOX GOLDEN SATIN STEEL

72584000



7 640163 974638

2015 - LADY TINA GREEN & PIETRO MINGARELLI POUR LALIQUE

BARS - BARS

DRAGON SANS TIROIR LATÉRAL / *WITHOUT SIDE DRAWER* ÉDITION NUMÉROTÉE / *NUMBERED EDITION*

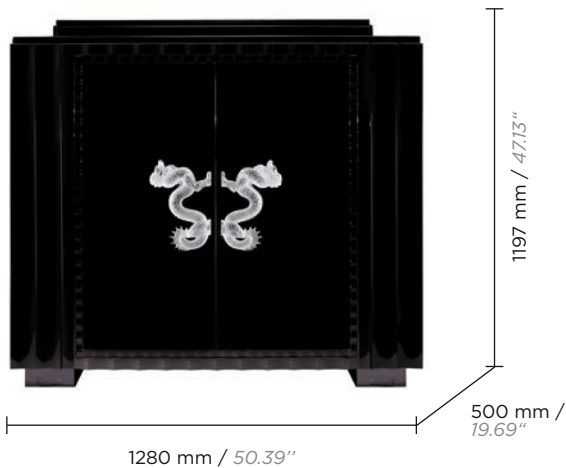

PM / SS

114 kg / 251.30 pounds

Dimensions incluant les poignées en cristal. /
Dimensions including the crystal handles.

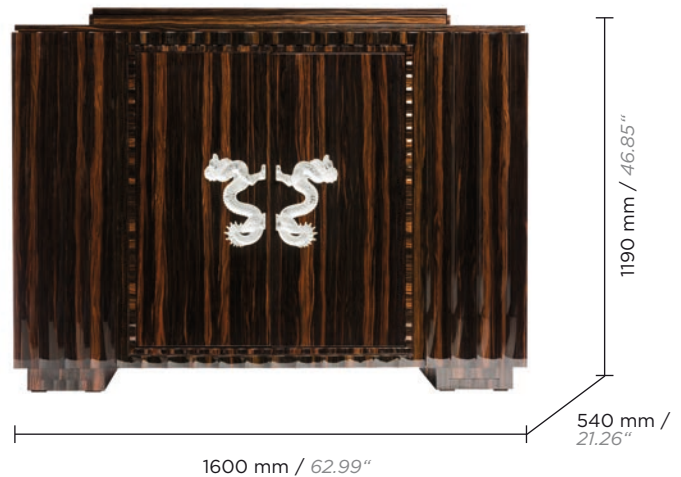

GM / LS

150 kg / 330.70 pounds

Dimensions incluant les poignées en cristal. /
Dimensions including the crystal handles.

FINITION / *FINISHING*

REFERENCE

EAN CODE



PM / SS

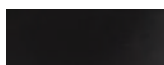

CRISTAL INCOLORE - *CLEAR CRYSTAL*
ÉBÈNE NOIR - *BLACK EBONY*

10179205



7 640111 508458

2014 - LADY TINA GREEN & PIETRO MINGARELLI POUR LALIQUE



CRISTAL INCOLORE - *CLEAR CRYSTAL*
ÉBÈNE NOIR - *BLACK EBONY*

10179200



7 640111 493747



CRISTAL INCOLORE - *CLEAR CRYSTAL*
FRÈNE IVOIRE - *IVORY ASH*

10179300



7 640111 493754

2011 - LADY TINA GREEN & PIETRO MINGARELLI POUR LALIQUE



GM / LS



CRISTAL INCOLORE - *CLEAR CRYSTAL*
ÉBÈNE NATUREL - *NATURAL EBONY*

10179210



7 640111 506270

2013 - LADY TINA GREEN & PIETRO MINGARELLI POUR LALIQUE



CRISTAL INCOLORE - *CLEAR CRYSTAL*
LAQUÉ NOIR - *BLACK LACQUERED*

72119000



7 640163 972689

2016 - LADY TINA GREEN & PIETRO MINGARELLI POUR LALIQUE

FEMME BRAS LEVÉS AVEC TIROIRS LATÉRAUX / WITH SIDE DRAWERS ÉDITION NUMÉROTÉE / NUMBERED EDITION















183 kg / 403.40 pounds

Dimensions incluant les poignées en cristal. /
Dimensions including the crystal handles.

FINITION / FINISHING

REFERENCE

EAN CODE

 	CRISTAL INCOLORE - CLEAR CRYSTAL ÉBÈNE NOIR - BLACK EBONY	10178800	 7 640111 505341
 	CRISTAL INCOLORE - CLEAR CRYSTAL FRÊNE IVOIRE - IVORY ASH	10178900	 7 640111 493792
2011 - LADY TINA GREEN & PIETRO MINGARELLI POUR LALIQUE			
 	CRISTAL INCOLORE - CLEAR CRYSTAL ÉBÈNE NATUREL - NATURAL EBONY	10178850	 7 640111 508311
2013 - LADY TINA GREEN & PIETRO MINGARELLI POUR LALIQUE			
 	CRISTAL INCOLORE - CLEAR CRYSTAL BLEU EUCALYPTUS - BLUE EUCALYPTUS	72155000	 7 640163 975918
2015 - LADY TINA GREEN & PIETRO MINGARELLI POUR LALIQUE			

JOUEUR DE PIPEAU AVEC TIROIRS LATÉRAUX / WITH SIDE DRAWERS ÉDITION NUMÉROTÉE / NUMBERED EDITION



183 kg / 403.40 pounds

Dimensions incluant les poignées en cristal. /
Dimensions including the crystal handles.

FINITION / FINISHING	REFERENCE	EAN CODE
  CRISTAL INCOLORE - CLEAR CRYSTAL ÉBÈNE NOIR - BLACK EBONY	10179400	 7 640111 493815
  CRISTAL INCOLORE - CLEAR CRYSTAL FRÈNE IVOIRE - IVORY ASH	10179500	 7 640111 493822
2011 - LADY TINA GREEN & PIETRO MINGARELLI POUR LALIQUE		
  CRISTAL INCOLORE - CLEAR CRYSTAL ÉBÈNE NATUREL - NATURAL EBONY	10179450	 7 640111 508328
2013 - LADY TINA GREEN & PIETRO MINGARELLI POUR LALIQUE		
  CRISTAL INCOLORE - CLEAR CRYSTAL BLEU EUCALYPTUS - BLUE EUCALYPTUS	72153000	 7 640163 978896
2015 - LADY TINA GREEN & PIETRO MINGARELLI POUR LALIQUE		

BARS - BARS

LONGCHAMP
SANS TIROIR LATÉRAL / *WITHOUT SIDE DRAWER*
ÉDITION NUMÉROTÉE / *NUMBERED EDITION*



150 kg / 330.70 pounds

Dimensions incluant les poignées en cristal. /
Dimensions including the crystal handles.

FINITION / FINISHING



CRISTAL INCOLORE - *CLEAR CRYSTAL*
ÉBÈNE NATUREL - *NATURAL EBONY*

REFERENCE

10178605

EAN CODE



CRISTAL INCOLORE - *CLEAR CRYSTAL*
ÉBÈNE NOIR - *BLACK EBONY*

10178610



CRISTAL INCOLORE - *CLEAR CRYSTAL*
FRÈNE IVOIRE - *IVORY ASH*

72147000



2014 - LADY TINA GREEN & PIETRO MINGARELLI POUR LALIQUE

MASQUE DE FEMME SANS TIROIR LATÉRAL / *WITHOUT SIDE DRAWER* ÉDITION NUMÉROTÉE / *NUMBERED EDITION*

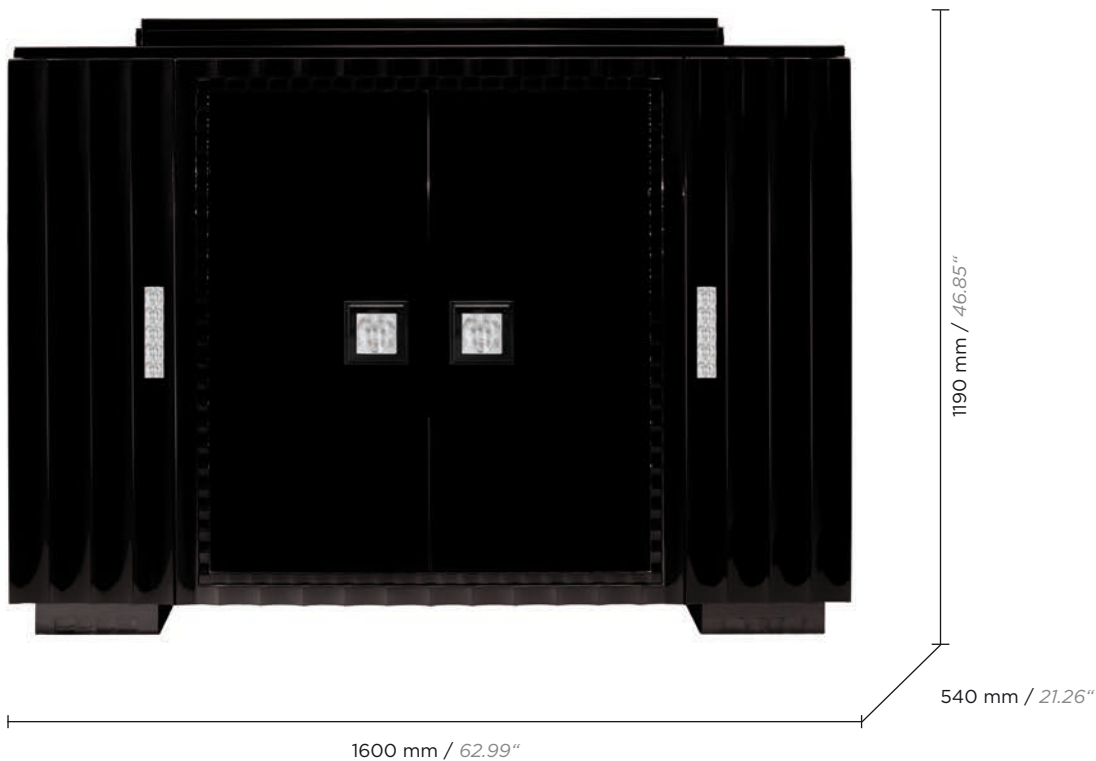

150 kg / 330.70 pounds

Dimensions incluant les poignées en cristal. /
Dimensions including the crystal handles.















FINITION / FINISHING	REFERENCE	EAN CODE
 CRISTAL INCOLORE - <i>CLEAR CRYSTAL</i> ÉBÈNE NOIR - <i>BLACK EBONY</i>	10179000	 7 640111 493761
 CRISTAL INCOLORE - <i>CLEAR CRYSTAL</i> FRÈNE IVOIRE - <i>IVORY ASH</i>	10179100	 7 640111 493778
2011 - LADY TINA GREEN & PIETRO MINGARELLI POUR LALIQUE		
 CRISTAL INCOLORE - <i>CLEAR CRYSTAL</i> ÉBÈNE NATUREL - <i>NATURAL EBONY</i>	10179050	 7 640111 508304
2013 - LADY TINA GREEN & PIETRO MINGARELLI POUR LALIQUE		

MERLES ET RAISINS AVEC TIROIRS LATÉRAUX / WITH SIDE DRAWERS ÉDITION NUMÉROTÉE / NUMBERED EDITION



183 kg / 403.40 pounds

Dimensions incluant les poignées en cristal. /
Dimensions including the crystal handles.

FINITION / FINISHING	REFERENCE	EAN CODE
  CRISTAL INCOLORE - CLEAR CRYSTAL ÉBÈNE NOIR - BLACK EBONY	10179600	 7 640111 493839
  CRISTAL INCOLORE - CLEAR CRYSTAL FRÈNE IVOIRE - IVORY ASH	10179700	 7 640111 493846
2011 - LADY TINA GREEN & PIETRO MINGARELLI POUR LALIQUE		
  CRISTAL INCOLORE - CLEAR CRYSTAL ÉBÈNE NATUREL - NATURAL EBONY	10179605	 7 640111 506287
2013 - LADY TINA GREEN & PIETRO MINGARELLI POUR LALIQUE		
  CRISTAL INCOLORE - CLEAR CRYSTAL ÉBÈNE NATUREL - NATURAL EBONY ACIER DORÉ - INOX GOLDEN SATIN STEEL	72124002	 7 640163 974591
2015 - LADY TINA GREEN & PIETRO MINGARELLI POUR LALIQUE		
  CRISTAL LUSTRÉ OR - GOLD LUSTER CRYSTAL ACIER DORÉ - INOX GOLDEN SATIN STEEL BOIS NATUREL - NATURAL WOOD	72192000	 7 640182 870058
2018 - LADY TINA GREEN & PIETRO MINGARELLI POUR LALIQUE		

BARS - *BARS*

RAISINS

ÉDITION NUMÉROTÉE / *NUMBERED EDITION*



FINITION / *FINISHING*

REFERENCE

EAN CODE



CRISTAL INCOLORE - *CLEAR CRYSTAL*
LAQUÉ NOIR - *BLACK LACQUERED*
TOP EN VERRE NOIR - *BLACK GLASS TOP*

10179610



7 640111 506294

2013 - LADY TINA GREEN & PIETRO MINGARELLI POUR LALIQUE



FINITION / *FINISHING*

REFERENCE

EAN CODE



CRISTAL INCOLORE - *CLEAR CRYSTAL*
LAQUÉ NOIR - *BLACK LACQUERED*
3 PORTES ARRIÈRES - *3 DOORS AT THE BACK*

72112410



7 640163 972061

2016 - LADY TINA GREEN & PIETRO MINGARELLI POUR LALIQUE

RAISINS

ÉDITION NUMÉROTÉE / NUMBERED EDITION



2350 mm / 92.52"

930 mm / 36.61"

480 mm / 18.90"

Laqué noir / Black lacquered



2350 mm / 92.52"

1160 mm / 45.66"

480 mm / 18.90"

198 kg / 436.50 pounds











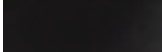

















Ébène naturel / Natural ebony

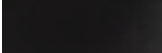

FINITION / FINISHING

REFERENCE

EAN CODE

L930 x 1480 x H2350 mm <i>L36.61" x W18.90"</i> <i>x H92.52"</i>			CRISTAL INCOLORE - <i>CLEAR CRYSTAL</i> LAQUÉ NOIR - <i>BLACK LACQUERED</i>	10293410	
	2013 - LADY TINA GREEN & PIETRO MINGARELLI POUR LALIQUE				7 640111 506614
			CRISTAL INCOLORE - <i>CLEAR CRYSTAL</i> ÉBÈNE NATUREL - <i>NATURAL EBONY</i>	10293411	
2014 - LADY TINA GREEN & PIETRO MINGARELLI POUR LALIQUE				7 640111 508564	
L1160 x 1480 x H2350 mm 198 kg <i>L45.66" x W18.90"</i> <i>x H92.52"</i> <i>436.5 pounds</i>			CRISTAL INCOLORE - <i>CLEAR CRYSTAL</i> BLEU EUCALYPTUS - <i>BLUE EUCALYPTUS</i>	72252120	
	2016 - LADY TINA GREEN & PIETRO MINGARELLI POUR LALIQUE				7 640163 972818
			CRISTAL INCOLORE - <i>CLEAR CRYSTAL</i> LAQUÉ NOIR - <i>BLACK LACQUERED</i>	10293400	
2012 - LADY TINA GREEN & PIETRO MINGARELLI POUR LALIQUE				7 640111 496182	
L1700 x 1480 x H2350 mm 198 kg <i>L45.66" x W18.90"</i> <i>x H92.52"</i> <i>436.5 pounds</i>			CRISTAL INCOLORE - <i>CLEAR CRYSTAL</i> ÉBÈNE NATUREL - <i>NATURAL EBONY</i>	10293401	
	2014 - LADY TINA GREEN & PIETRO MINGARELLI POUR LALIQUE				7 640111 508557
			CRISTAL INCOLORE - <i>CLEAR CRYSTAL</i> BLEU EUCALYPTUS - <i>BLUE EUCALYPTUS</i>	72252220	
2016 - LADY TINA GREEN & PIETRO MINGARELLI POUR LALIQUE				7 640163 972825	
L1700 x 1480 x H2350 mm 198 kg <i>L45.66" x W18.90"</i> <i>x H92.52"</i> <i>436.5 pounds</i>			CRISTAL INCOLORE - <i>CLEAR CRYSTAL</i> LAQUÉ NOIR - <i>BLACK LACQUERED</i>	10293430	
	2013 - LADY TINA GREEN & PIETRO MINGARELLI POUR LALIQUE				7 640111 506621
			CRISTAL INCOLORE - <i>CLEAR CRYSTAL</i> ÉBÈNE NATUREL - <i>NATURAL EBONY</i>	10293431	
2014 - LADY TINA GREEN & PIETRO MINGARELLI POUR LALIQUE				7 640111 508571	
L2250 x 1480 x H2350 mm 465 kg <i>L88.58" x W18.90"</i> <i>x H92.52"</i> <i>1025.15 pounds</i>			CRISTAL INCOLORE - <i>CLEAR CRYSTAL</i> BLEU EUCALYPTUS - <i>BLUE EUCALYPTUS</i>	72251323	
	2016 - LADY TINA GREEN & PIETRO MINGARELLI POUR LALIQUE				7 640163 972832
			CRISTAL INCOLORE - <i>CLEAR CRYSTAL</i> LAQUÉ NOIR - <i>BLACK LACQUERED</i>	10293420	
2013 - LADY TINA GREEN & PIETRO MINGARELLI POUR LALIQUE				7 640111 506638	
L2250 x 1480 x H2350 mm 465 kg <i>L88.58" x W18.90"</i> <i>x H92.52"</i> <i>1025.15 pounds</i>			CRISTAL INCOLORE - <i>CLEAR CRYSTAL</i> ÉBÈNE NATUREL - <i>NATURAL EBONY</i>	10293421	
	2014 - LADY TINA GREEN & PIETRO MINGARELLI POUR LALIQUE				7 640111 508588
			CRISTAL INCOLORE - <i>CLEAR CRYSTAL</i> BLEU EUCALYPTUS - <i>BLUE EUCALYPTUS</i>	72252420	
2016 - LADY TINA GREEN & PIETRO MINGARELLI POUR LALIQUE				7 640163 972849	
L3300 x 1480 x H2350 mm 465 kg <i>L129.92" x W18.90"</i> <i>x H92.52"</i> <i>1025.15 pounds</i>			CRISTAL INCOLORE - <i>CLEAR CRYSTAL</i> LAQUÉ NOIR - <i>BLACK LACQUERED</i>	10293440	
	2013 - LADY TINA GREEN & PIETRO MINGARELLI POUR LALIQUE				7 640111 506645
			CRISTAL INCOLORE - <i>CLEAR CRYSTAL</i> ÉBÈNE NATUREL - <i>NATURAL EBONY</i>	10293441	
2014 - LADY TINA GREEN & PIETRO MINGARELLI POUR LALIQUE				7 640111 508595	
L3300 x 1480 x H2350 mm 465 kg <i>L129.92" x W18.90"</i> <i>x H92.52"</i> <i>1025.15 pounds</i>			CRISTAL INCOLORE - <i>CLEAR CRYSTAL</i> BLEU EUCALYPTUS - <i>BLUE EUCALYPTUS</i>	72252520	
	2016 - LADY TINA GREEN & PIETRO MINGARELLI POUR LALIQUE				7 640163 972856

Bibliothèque livrée sans éclairage ni portes en verre. Les éclairages et portes en verre peuvent être commandés séparément. /
 Library delivered without lightings neither glass doors. Lightings and glass doors can be ordered separately.

BUREAUX - DESKS

RAISINS

ÉDITION NUMÉROTÉE / *NUMBERED EDITION*



145 kg / 319.70 pounds

FINITION / *FINISHING*

REFERENCE

EAN CODE



CRISTAL INCOLORE - *CLEAR CRYSTAL*
LAQUÉ NOIR - *BLACK LACQUERED*

10293500



2012 - LADY TINA GREEN & PIETRO MINGARELLI POUR LALIQUE



CRISTAL INCOLORE - *CLEAR CRYSTAL*
BLEU EUCALYPTUS - *BLUE EUCALYPTUS*

72352000



2015 - LADY TINA GREEN & PIETRO MINGARELLI POUR LALIQUE

CABINET - *CABINET*

RAISINS

ÉDITION NUMÉROTÉE / *NUMBERED EDITION*



FINITION / *FINISHING*

REFERENCE

EAN CODE



CRISTAL INCOLORE - *CLEAR CRYSTAL*
LAQUÉ NOIR - *BLACK LACQUERED*
AVEC MIRROIR - *WITH MIRROR*

72612630



2016 - LADY TINA GREEN & PIETRO MINGARELLI POUR LALIQUE

COIFFEUSES - *DRESSING TABLES*

MASQUE DE FEMME

ÉDITION NUMÉROTÉE / *NUMBERED EDITION*



FINITION / <i>FINISHING</i>	REFERENCE	EAN CODE
 CRISTAL INCOLORE - <i>CLEAR CRYSTAL</i> LAQUÉ NOIR - <i>BLACK LACQUERED</i> 2013 - LADY TINA GREEN & PIETRO MINGARELLI POUR LALIQUE	10190020	7 640111 506607
 CRISTAL INCOLORE - <i>CLEAR CRYSTAL</i> ÉBÈNE NATUREL - <i>NATURAL EBONY</i> TOP EN GRANITE NOIR - <i>BLACK GRANITE TOP</i> 2014 - LADY TINA GREEN & PIETRO MINGARELLI POUR LALIQUE	73421000	7 640111 509301
 CRISTAL INCOLORE - <i>CLEAR CRYSTAL</i> FRÈNE IVOIRE - <i>IVORY ASH</i> TOP EN GRANITE NOIR - <i>BLACK GRANITE TOP</i> 2015 - LADY TINA GREEN & PIETRO MINGARELLI POUR LALIQUE	73441000	7 640163 975475
 CRISTAL INCOLORE - <i>CLEAR CRYSTAL</i> BLEU EUCALYPTUS - <i>BLUE EUCALYPTUS</i> TOP EN GRANITE NOIR - <i>BLACK GRANITE TOP</i> 2018 - LADY TINA GREEN & PIETRO MINGARELLI POUR LALIQUE	73441000	7 640163 973808

COIFFEUSES - *DRESSING TABLES*

RAISINS



Photo non contractuelle / Non contractual picture

125 kg / 275.60 pounds

FINITION / FINISHING

REFERENCE

EAN CODE



CRISTAL INCOLORE - CLEAR CRYSTAL
LAQUÉ NOIR - BLACK LACQUERED

73412000



7 640163 976212

2015 - LADY TINA GREEN & PIETRO MINGARELLI POUR LALIQUE

COIFFEUSES - *DRESSING TABLES*

RAISINS



125 kg / 275.60 pounds

FINITION / FINISHING

REFERENCE

EAN CODE



CRISTAL LUSTRÉ OR - GOLD LUSTER CRYSTAL
ACIER DORÉ - INOX GOLDEN SATIN STEEL
BOIS NATUREL - NATURAL WOOD

73462350



7 640182 870034

2018 - LADY TINA GREEN & PIETRO MINGARELLI POUR LALIQUE

COMMODES - DRAWER UNIT

RAISINS

ÉDITION NUMÉROTÉE / NUMBERED EDITION



130 kg / 286.60 pounds

FINITION / FINISHING

REFERENCE

EAN CODE



CRISTAL INCOLORE - CLEAR CRYSTAL
LAQUÉ NOIR - BLACK LACQUERED
4 TIROIRS - 4 DRAWERS

72712510



7 640163 972092

2016 - LADY TINA GREEN & PIETRO MINGARELLI POUR LALIQUE

COMMODES - *TALL BOY*

MASQUE DE FEMME

6 TIROIRS / 6 *DRAWERS*

ÉDITION NUMÉROTÉE / *NUMBERED EDITION*



FINITION / *FINISHING*

REFERENCE

EAN CODE



CRISTAL INCOLORE - *CLEAR CRYSTAL*
LAQUÉ NOIR - *BLACK LACQUERED*
ACIER POLI - *POLISHED STEEL*

10190120



7 640111 506874

2013 - LADY TINA GREEN & PIETRO MINGARELLI POUR LALIQUE



CRISTAL INCOLORE - *CLEAR CRYSTAL*
ÉBÈNE NATUREL - *NATURAL EBONY*
ACIER POLI - *POLISHED STEEL*

73621000



7 640111 509318

2014 - LADY TINA GREEN & PIETRO MINGARELLI POUR LALIQUE

RAISINS 6 TIROIRS / 6 *DRAWERS* ÉDITION NUMÉROTÉE / *NUMBERED EDITION*



Photos non contractuelles / *Non contractual pictures*

FINITION / *FINISHING*

REFERENCE

EAN CODE



CRISTAL INCOLORE - *CLEAR CRYSTAL*
ÉBÈNE NATUREL - *NATURAL EBONY*
ACIER POLI - *POLISHED STEEL*

73622000



7 640163 975987

2014 - LADY TINA GREEN & PIETRO MINGARELLI POUR LALIQUE

CONSOLES - CONSOLES

LONGCHAMP

MM / MS

ÉDITION NUMÉROTÉE / NUMBERED EDITION



FINITION / FINISHING

REFERENCE

EAN CODE



CRISTAL INCOLORE - CLEAR CRYSTAL
ÉBÈNE NATUREL - NATURAL EBONY
TOP EN GRANITE NOIR - BLACK GRANITE TOP

11180210



2013 - LADY TINA GREEN & PIETRO MINGARELLI POUR LALIQUE

CONSOLES - CONSOLES

MASQUE DE FEMME

ÉDITION NUMÉROTÉE / *NUMBERED EDITION*

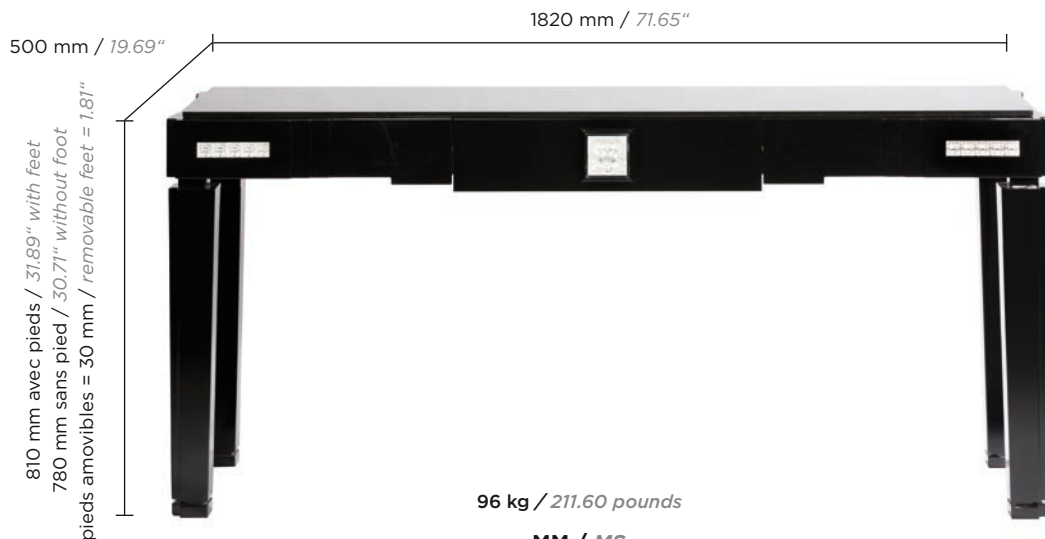

96 kg / 211.60 pounds

MM / MS

Laqué noir / *Black lacquered*



GM / LS

Frêne ivoire / *Ivory ash*

FINITION / *FINISHING*

REFERENCE

EAN CODE



MM / MS



CRISTAL INCOLORE - *CLEAR CRYSTAL*
FRÊNE IVOIRE - *IVORY ASH*
TOP EN GRANITE NOIR - *BLACK GRANITE TOP*

2012 - LADY TINA GREEN & PIETRO MINGARELLI POUR LALIQUE

11180200



7 640111 504368



CRISTAL INCOLORE - *CLEAR CRYSTAL*
LAQUÉ NOIR - *BLACK LACQUERED*
TOP EN GRANITE NOIR - *BLACK GRANITE TOP*

2011 - LADY TINA GREEN & PIETRO MINGARELLI POUR LALIQUE

10180200



7 640111 493853



GM / LS



CRISTAL INCOLORE - *CLEAR CRYSTAL*
FRÊNE IVOIRE - *IVORY ASH*
TOP EN GRANITE NOIR - *BLACK GRANITE TOP*

2013 - LADY TINA GREEN & PIETRO MINGARELLI POUR LALIQUE

10180211



7 640111 506300

CONSOLES - CONSOLES

MASQUE DE FEMME CIRCULAIRE / CIRCULAR

ÉDITION NUMÉROTÉE / NUMBERED EDITION



FINITION / FINISHING

REFERENCE

EAN CODE



CRISTAL INCOLORE - CLEAR CRYSTAL
LAQUÉ NOIR - BLACK LACQUERED
TOP EN GRANITE NOIR - BLACK GRANITE TOP

11180220



7 640111 506553

2013 - LADY TINA GREEN & PIETRO MINGARELLI POUR LALIQUE



CRISTAL INCOLORE - CLEAR CRYSTAL
ÉBÈNE NATUREL - NATURAL EBONY
TOP EN GRANITE NOIR - BLACK GRANITE TOP

73521000



7 640163 976236

2015 - LADY TINA GREEN & PIETRO MINGARELLI POUR LALIQUE

CONSOLES - CONSOLES

RAISINS
CIRCULAIRE / *CIRCULAR*
ÉDITION NUMÉROTÉE / *NUMBERED EDITION*



45 kg / 99.21 pounds

FINITION / *FINISHING*

REFERENCE

EAN CODE



CRISTAL INCOLORE - *CLEAR CRYSTAL*
LAQUÉ NOIR - *BLACK LACQUERED*
TOP EN GRANITE NOIR - *BLACK GRANITE TOP*

73512000



7 640163 975901

2016 - LADY TINA GREEN & PIETRO MINGARELLI POUR LALIQUE

CONSOLES - CONSOLES

RAISINS

ÉDITION NUMÉROTÉE / NUMBERED EDITION



RECTANGULAIRE / RECTANGULAR



CIRCULAIRE / CIRCULAR

FINITION / FINISHING

REFERENCE

EAN CODE



CRISTAL INCOLORE - CLEAR CRYSTAL
ÉBÈNE NATUREL - NATURAL EBONY
TOP EN GRANITE NOIR - BLACK GRANITE TOP

73522000



**RECTANGULAIRE
RECTANGULAR**



CRISTAL INCOLORE - CLEAR CRYSTAL
FRÈNE IVOIRE - IVORY ASH
TOP EN GRANITE NOIR - BLACK GRANITE TOP

11180205



2014 - LADY TINA GREEN & PIETRO MINGARELLI POUR LALIQUE



CRISTAL INCOLORE - CLEAR CRYSTAL
LAQUÉ NOIR - BLACK LACQUERED
TOP EN GRANITE NOIR - BLACK GRANITE TOP

73512040



2018 - LADY TINA GREEN & PIETRO MINGARELLI POUR LALIQUE



**CIRCULAIRE
CIRCULAR**



CRISTAL INCOLORE - CLEAR CRYSTAL
LAQUÉ NOIR - BLACK LACQUERED
TOP EN GRANITE NOIR - BLACK GRANITE TOP

73512600



2017 - LADY TINA GREEN & PIETRO MINGARELLI POUR LALIQUE

CONSOLES - CONSOLES

ROSES

ÉDITION NUMÉROTÉE / NUMBERED EDITION



FINITION / FINISHING

REFERENCE

EAN CODE



CRISTAL INCOLORE - CLEAR CRYSTAL
ÉBÈNE NATUREL - NATURAL EBONY
TOP EN GRANITE NOIR - BLACK GRANITE TOP

10180212



CRISTAL INCOLORE - CLEAR CRYSTAL
BLEU EUCALYPTUS - BLUE EUCALYPTUS
TOP EN GRANITE NOIR - BLACK GRANITE TOP

73550000



2014 - LADY TINA GREEN & PIETRO MINGARELLI POUR LALIQUE



CRISTAL INCOLORE - CLEAR CRYSTAL
LAQUÉ NOIR - BLACK LACQUERED
TOP EN GRANITE NOIR - BLACK GRANITE TOP

73519000



2015 - LADY TINA GREEN & PIETRO MINGARELLI POUR LALIQUE

CRÉDENCES - *SIDEBOARDS*

DRAGON

ÉDITION NUMÉROTÉE / *NUMBERED EDITION*



87 kg / 191.80 pounds

FINITION / *FINISHING*

REFERENCE

EAN CODE



CRISTAL INCOLORE - *CLEAR CRYSTAL*
FRÊNE IVOIRE - *IVORY ASH*

10179910



7 640111 506591



CRISTAL INCOLORE - *CLEAR CRYSTAL*
LAQUÉ NOIR - *BLACK LACQUERED*

72419000



7 640163 972016

2013 - LADY TINA GREEN & PIETRO MINGARELLI POUR LALIQUE

CRÉDENCES - *SIDEBOARDS*

MASQUE DE FEMME

ÉDITION NUMÉROTÉE / *NUMBERED EDITION*



FINITION / *FINISHING*

REFERENCE

EAN CODE



CRISTAL INCOLORE - *CLEAR CRYSTAL*
FRÊNE IVOIRE - *IVORY ASH*

10180100



CRISTAL INCOLORE - *CLEAR CRYSTAL*
LAQUÉ NOIR - *BLACK LACQUERED*

10180000



2011 - LADY TINA GREEN & PIETRO MINGARELLI POUR LALIQUE

CRÉDENCES - *SIDEBOARDS*

RAISINS



FINITION / *FINISHING*

REFERENCE

EAN CODE



CRISTAL LUSTRÉ OR - *GOLD LUSTER CRYSTAL*
ACIER DORÉ - *INOX GOLDEN SATIN STEEL*
BOIS NATUREL - *NATURAL WOOD*
TOP EN GRANITE - *GRANITE TOP*

72492300



7 640182 870041

2018 - LADY TINA GREEN & PIETRO MINGARELLI POUR LALIQUE

CRÉDENCES - *SIDEBOARDS*

RAISINS

ÉDITION NUMÉROTÉE / *NUMBERED EDITION*



Laqué noir / *Black lacquered*



Frêne ivoire / *Ivory ash*



FINITION / *FINISHING*

REFERENCE

EAN CODE

L1800 x I480 x H810 mm
*L70.87\" x W18.90\"
x H31.89\"*



CRISTAL INCOLORE - *CLEAR CRYSTAL*
LAQUÉ NOIR - *BLACK LACQUERED*
ACIER POLI - *POLISHED STEEL*

72412100



2015 - LADY TINA GREEN & PIETRO MINGARELLI POUR LALIQUE



CRISTAL INCOLORE - *CLEAR CRYSTAL*
FRÊNE IVOIRE - *IVORY ASH*
ACIER POLI - *POLISHED STEEL*

10179900



CRISTAL INCOLORE - *CLEAR CRYSTAL*
LAQUÉ NOIR - *BLACK LACQUERED*
ACIER POLI - *POLISHED STEEL*

10179800



L2050 x I480 x H810 mm
*L80.71\" x W18.90\"
x H31.89\"*



CRISTAL INCOLORE - *CLEAR CRYSTAL*
ÉBÈNE NATUREL - *NATURAL EBONY*
ACIER DORÉ - *INOX GOLDEN SATIN STEEL*

72422002



CRISTAL INCOLORE - *CLEAR CRYSTAL*
FRÊNE IVOIRE - *IVORY ASH*
ACIER DORÉ - *INOX GOLDEN SATIN STEEL*

72442004



2015 - LADY TINA GREEN & PIETRO MINGARELLI POUR LALIQUE



CRISTAL INCOLORE - *CLEAR CRYSTAL*
ÉBÈNE NATUREL - *NATURAL EBONY*
ACIER DORÉ - *INOX GOLDEN SATIN STEEL*

72422006



2018 - LADY TINA GREEN & PIETRO MINGARELLI POUR LALIQUE

TABLES - TABLES

RAISINS

ÉDITION NUMÉROTÉE / *NUMBERED EDITION*



FINITION / *FINISHING*

REFERENCE

EAN CODE



8 PERSONNES MAXIMUM - 8 PERSONS MAXIMUM
CRISTAL INCOLORE - *CLEAR CRYSTAL*
LAQUÉ NOIR - *BLACK LACQUERED*

10293601



10 PERSONNES MAXIMUM - 10 PERSONS MAXIMUM
CRISTAL INCOLORE - *CLEAR CRYSTAL*
LAQUÉ NOIR - *BLACK LACQUERED*

10293600



2012 - LADY TINA GREEN & PIETRO MINGARELLI POUR LALIQUE

TABLES - TABLES

RAISINS
CARRÉ / SQUARE
RONDE / ROUND



FINITION / FINISHING

REFERENCE

EAN CODE



CARRÉ / SQUARE



6 PERSONNES MAXIMUM - 6 PERSONS MAXIMUM
CRISTAL INCOLORE - CLEAR CRYSTAL
LAQUÉ NOIR - BLACK LACQUERED

73112710



RONDE / ROUND



6 PERSONNES MAXIMUM - 6 PERSONS MAXIMUM
CRISTAL INCOLORE - CLEAR CRYSTAL
LAQUÉ NOIR - BLACK LACQUERED

73112410



2017 - LADY TINA GREEN & PIETRO MINGARELLI POUR LALIQUE

TABLES D'APPOINT - SIDE TABLES

MASQUE DE FEMME

ÉDITION NUMÉROTÉE / NUMBERED EDITION



75 kg / 165.35 pounds

Laqué noir / Black lacquered



Ébène naturel / Natural ebony

FINITION / FINISHING	REFERENCE	EAN CODE
 <p>CRISTAL INCOLORE - CLEAR CRYSTAL ACIER POLI - POLISHED STEEL LAQUÉ NOIR - BLACK LACQUERED TOP EN GRANITE NOIR - BLACK GRANITE TOP</p> <p>2013 - LADY TINA GREEN & PIETRO MINGARELLI POUR LALIQUE</p>	10190030	 7 640111 506577
 <p>CRISTAL INCOLORE - CLEAR CRYSTAL ACIER POLI - POLISHED STEEL ÉBÈNE NATUREL - NATURAL EBONY TOP EN GRANITE NOIR - BLACK GRANITE TOP</p> <p>2014 - LADY TINA GREEN & PIETRO MINGARELLI POUR LALIQUE</p>	10190040	 7 640111 508502
 <p>CRISTAL INCOLORE - CLEAR CRYSTAL ACIER POLI - POLISHED STEEL ÉBÈNE NOIR - BLACK EBONY TOP EN GRANITE NOIR - BLACK GRANITE TOP</p> <p>2018 - LADY TINA GREEN & PIETRO MINGARELLI POUR LALIQUE</p>	73331000	 7 640111 509615
 <p>CRISTAL INCOLORE - CLEAR CRYSTAL ACIER POLI - POLISHED STEEL FRÈNE IVOIRE - IVORY ASH TOP EN GRANITE NOIR - BLACK GRANITE TOP</p> <p>2018 - LADY TINA GREEN & PIETRO MINGARELLI POUR LALIQUE</p>	73341000	 7 640163 971989

TABLES D'APPOINT - *SIDE TABLES*

RAISINS



75 kg / 165.35 pounds

FINITION / FINISHING

REFERENCE

EAN CODE



CRISTAL LUSTRÉ OR - *GOLD LUSTER CRYSTAL*
EBÈNE NATUREL - *NATURAL EBONY*
LAQUÉ VERT - *GREEN LACQUERED*

73362040



7 640182 870089

2018 - LADY TINA GREEN & PIETRO MINGARELLI POUR LALIQUE

TABLES D'APPOINT - *SIDE TABLES*

RAISINS

ÉDITION NUMÉROTÉE / *NUMBERED EDITION*

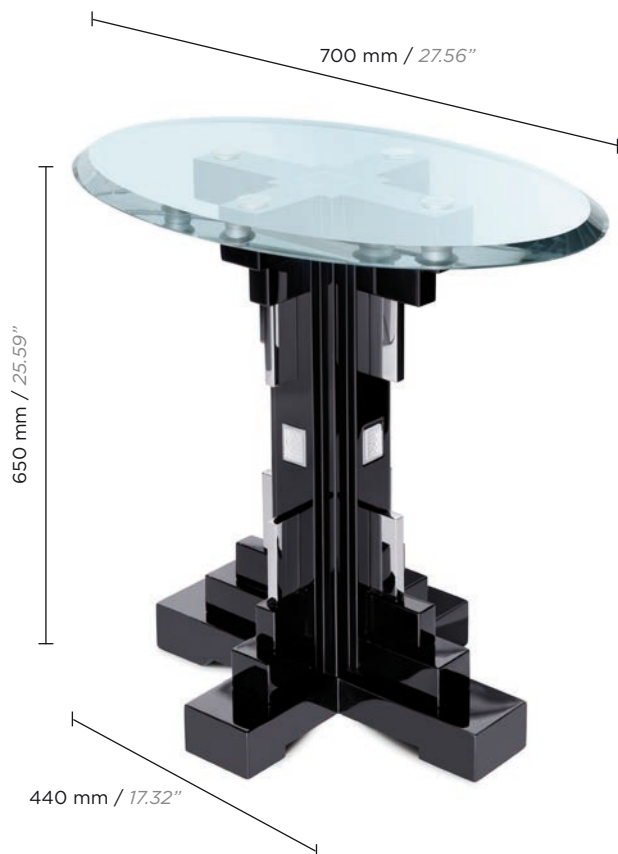

23 kg / 50.71 pounds

Ovale / *Ovale*



37 kg / 81.58 pounds

Rond / *Circolare*

FINITION / *FINISHING*

REFERENCE

EAN CODE



OVALE / *OVALE*



CRISTAL INCOLORE - *CLEAR CRYSTAL*
LAQUÉ NOIR - *BLACK LACQUERED*
TOP EN VERRE - *GLASS TOP*

73312510



ROND / *CIRCULARE*



CRISTAL INCOLORE - *CLEAR CRYSTAL*
LAQUÉ NOIR - *BLACK LACQUERED*
TOP EN VERRE - *GLASS TOP*

73312410



2016 - LADY TINA GREEN & PIETRO MINGARELLI POUR LALIQUE

TABLES BASSES - COFFEE TABLES

MASQUE DE FEMME

ÉDITION NUMÉROTÉE / NUMBERED EDITION

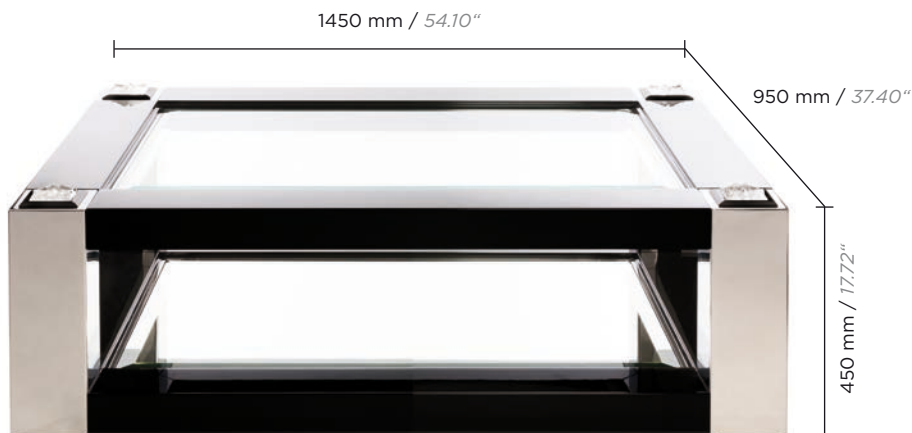

PM / SS

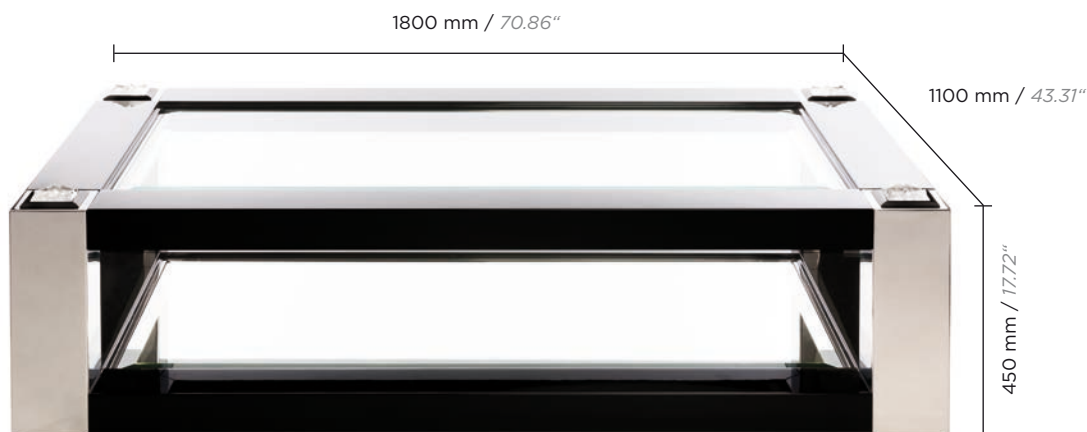

GM / LS

195 kg / 430 pounds

FINITION / FINISHING

REFERENCE

EAN CODE



PM / SS



CRISTAL INCOLORE - CLEAR CRYSTAL
LAQUÉ NOIR - BLACK LACQUERED
ACIER POLI - POLISHED STEEL

73211100



7 640111 509424



CRISTAL INCOLORE - CLEAR CRYSTAL
ÉBÈNE NATUREL - NATURAL EBONY
ACIER POLI - POLISHED STEEL

73221100



7 640111 509394

2014 - LADY TINA GREEN & PIETRO MINGARELLI POUR LALIQUE



GM / LS



CRISTAL INCOLORE - CLEAR CRYSTAL
LAQUÉ NOIR - BLACK LACQUERED
ACIER POLI - POLISHED STEEL

10293610



7 640111 506584



CRISTAL INCOLORE - CLEAR CRYSTAL
ÉBÈNE NATUREL - NATURAL EBONY
ACIER POLI - POLISHED STEEL

73221000



7 640111 509400

2014 - LADY TINA GREEN & PIETRO MINGARELLI POUR LALIQUE



CRISTAL INCOLORE - CLEAR CRYSTAL
LAQUÉ NOIR - BLACK LACQUERED
ÉBÈNE NATUREL - NATURAL EBONY

73211000



7 640163 974577

2015 - LADY TINA GREEN & PIETRO MINGARELLI POUR LALIQUE

TABLES BASSES - COFFEE TABLES

RAISINS



FINITION / FINISHING

REFERENCE

EAN CODE



CRISTAL LUSTRÉ OR - GOLD LUSTER CRYSTAL
EBÈNE NATUREL - NATURAL EBONY
LAQUÉ VERT - GREEN LACQUERED

73262130



2018 - LADY TINA GREEN & PIETRO MINGARELLI POUR LALIQUE

TABLES BASSES - COFFEE TABLES

RAISINS

ÉDITION NUMÉROTÉE / NUMBERED EDITION

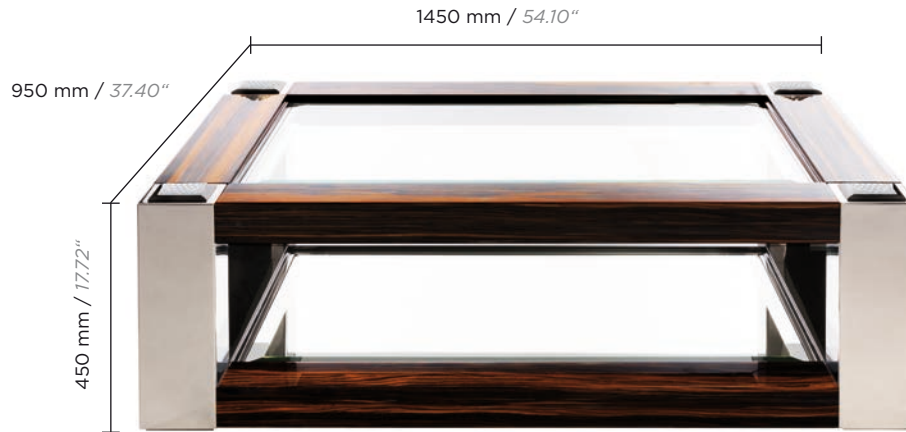

PM / SS

Ébène naturel - acier poli / Natural ebony - polished steel



GM / LS

Photos non contractuelles / Non contractual pictures

Laqué noir - ébène naturel / Black lacquered - natural ebony

FINITION / FINISHING

REFERENCE

EAN CODE



PM / SS



CRISTAL INCOLORE - CLEAR CRYSTAL
ÉBÈNE NATUREL - NATURAL EBONY
ACIER POLI - POLISHED STEEL

73222100



7 640163 975741



GM / LS



CRISTAL INCOLORE - CLEAR CRYSTAL
LAQUÉ NOIR - BLACK LACQUERED
ÉBÈNE NATUREL - NATURAL EBONY

73212000



7 640163 974584

2015 - LADY TINA GREEN & PIETRO MINGARELLI POUR LALIQUE

TABLES BASSES - COFFEE TABLES

RAISINS

ÉDITION NUMÉROTÉE / *NUMBERED EDITION*



FINITION / *FINISHING*

REFERENCE

EAN CODE



PM / SS



CRISTAL INCOLORE - *CLEAR CRYSTAL*
LAQUÉ NOIR - *BLACK LACQUERED*

73212630



GM / LS



CRISTAL INCOLORE - *CLEAR CRYSTAL*
LAQUÉ NOIR - *BLACK LACQUERED*

73212610



2017 - LADY TINA GREEN & PIETRO MINGARELLI POUR LALIQUE

TABLES DE CHEVET - *BEDSIDE TABLES*

MASQUE DE FEMME

ÉDITION NUMÉROTÉE / *NUMBERED EDITION*

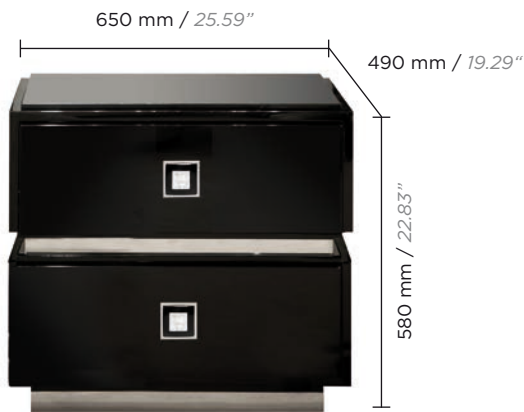

PM / SS

Laqué noir / *Black lacquered*



17 kg / *37.5 pounds*

GM / LS

Frêne ivoire / *Ivory ash*

FINITION / *FINISHING*

REFERENCE

EAN CODE



PM / SS



CRISTAL INCOLORE - *CLEAR CRYSTAL*
LAQUÉ NOIR - *BLACK LACQUERED*
TOP EN GRANITE NOIR - *BLACK GRANITE TOP*

10185105



7 640111 508342



CRISTAL INCOLORE - *CLEAR CRYSTAL*
ÉBÈNE NATUREL - *NATURAL EBONY*
TOP EN GRANITE NOIR - *BLACK GRANITE TOP*

74221100



7 640111 509295

2014 - LADY TINA GREEN & PIETRO MINGARELLI POUR LALIQUE



CRISTAL INCOLORE - *CLEAR CRYSTAL*
FRÊNE IVOIRE - *IVORY ASH*
TOP EN GRANITE NOIR - *BLACK GRANITE TOP*

74241100



7 640163 975260

2015 - LADY TINA GREEN & PIETRO MINGARELLI POUR LALIQUE

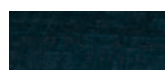

CRISTAL INCOLORE - *CLEAR CRYSTAL*
BLEU EUCALYPTUS - *BLUE EUCALYPTUS*
TOP EN GRANITE NOIR - *BLACK GRANITE TOP*

74251100



7 640163 973136

2018 - LADY TINA GREEN & PIETRO MINGARELLI POUR LALIQUE



GM / LS



CRISTAL INCOLORE - *CLEAR CRYSTAL*
LAQUÉ NOIR - *BLACK LACQUERED*

10185100



7 640111 494393



CRISTAL INCOLORE - *CLEAR CRYSTAL*
FRÊNE IVOIRE - *IVORY ASH*

10185200



7 640111 494409

2011 - LADY TINA GREEN & PIETRO MINGARELLI POUR LALIQUE

TABLES DE CHEVET - *BEDSIDE TABLES*

RAISINS

ÉDITION NUMÉROTÉE / *NUMBERED EDITION*

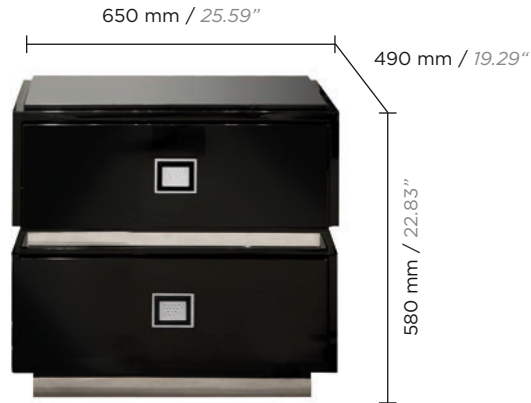

PM / SS

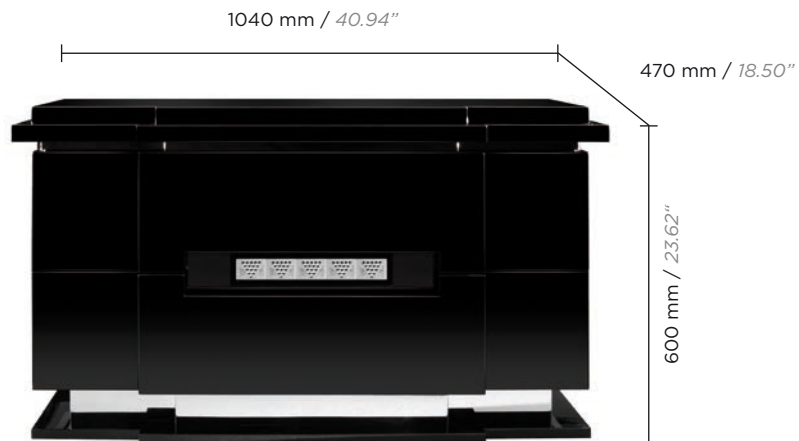

17 kg / 37.5 pounds

GM / LS

FINITION / *FINISHING*

REFERENCE

EAN CODE



PM / SS

CRISTAL INCOLORE - *CLEAR CRYSTAL*
LAQUÉ NOIR - *BLACK LACQUERED*
TOP EN GRANITE NOIR - *BLACK GRANITE TOP*

2014 - LADY TINA GREEN & PIETRO MINGARELLI POUR LALIQUE

10184905



7 640111 508335

CRISTAL INCOLORE - *CLEAR CRYSTAL*
FRÊNE IVOIRE - *IVORY ASH*
TOP EN GRANITE NOIR - *BLACK GRANITE TOP*

2015 - LADY TINA GREEN & PIETRO MINGARELLI POUR LALIQUE

74242100



7 640163 976083



GM / LS

CRISTAL INCOLORE - *CLEAR CRYSTAL*
LAQUÉ NOIR - *BLACK LACQUERED*

10184900



7 640111 494294

CRISTAL INCOLORE - *CLEAR CRYSTAL*
FRÊNE IVOIRE - *IVORY ASH*

2011 - LADY TINA GREEN & PIETRO MINGARELLI POUR LALIQUE

10185000



7 640111 494386

TABLES DE CHEVET - *BEDSIDE TABLES*

RAISINS



PM / SS

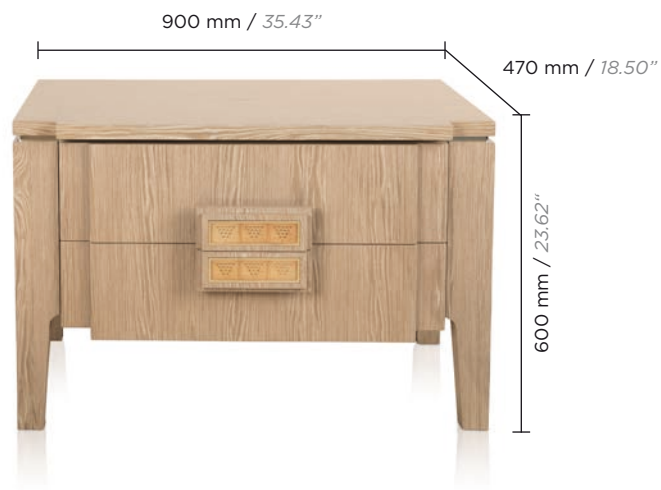

GM / LS

FINITION / FINISHING

REFERENCE

EAN CODE



PM / SS



CRISTAL LUSTRÉ OR - *GOLD LUSTER CRYSTAL*
BOIS NATUREL - *NATURAL WOOD*

74262410



7 640182 870027



GM / LS



CRISTAL LUSTRÉ OR - *GOLD LUSTER CRYSTAL*
BOIS NATUREL - *NATURAL WOOD*

74262510



7 640182 870010

2018 - LADY TINA GREEN & PIETRO MINGARELLI POUR LALIQUE

TABLES GIGOGNES - SIDE TABLES (NESTING TABLES)

MASQUE DE FEMME

ÉDITION NUMÉROTÉE / *NUMBERED EDITION*

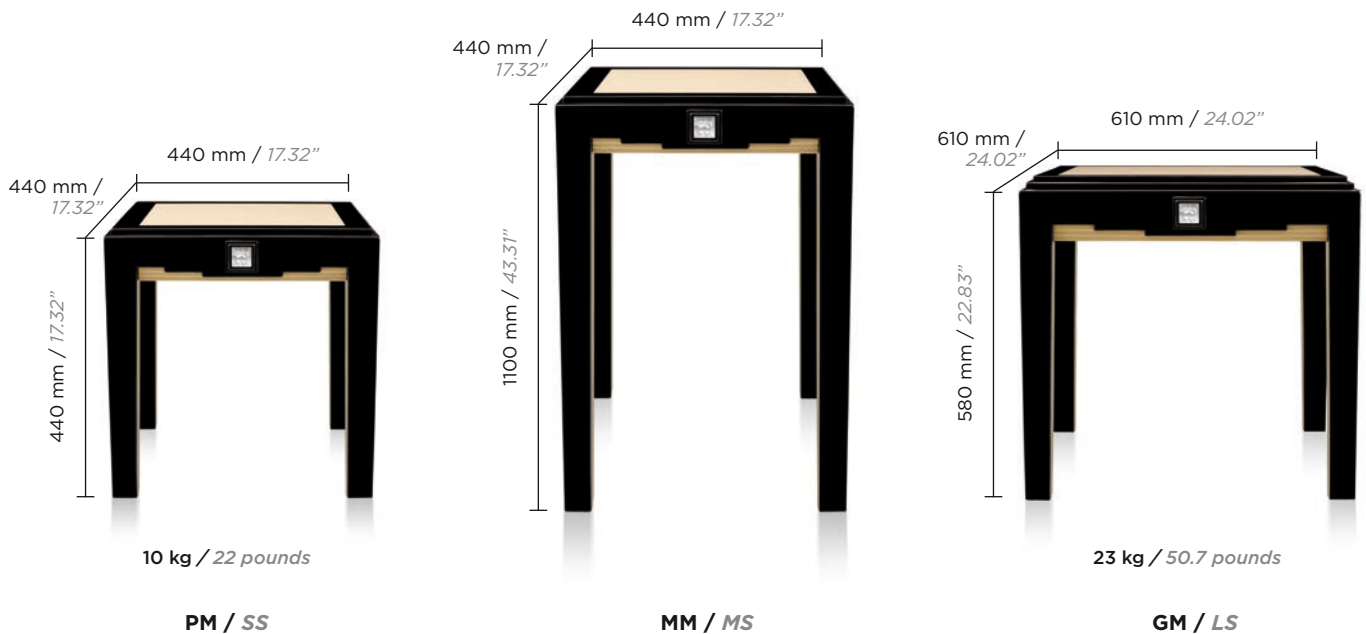

FINITION / *FINISHING*

REFERENCE

EAN CODE



PM / SS



CRISTAL INCOLORE - *CLEAR CRYSTAL*
LAQUÉ NOIR - *BLACK LACQUERED*
FRÈNE IVOIRE - *IVORY ASH*

2012 - LADY TINA GREEN & PIETRO MINGARELLI POUR LALIQUE

10180600



7 640111 493877



MM / MS



CRISTAL INCOLORE - *CLEAR CRYSTAL*
LAQUÉ NOIR - *BLACK LACQUERED*
FRÈNE IVOIRE - *IVORY ASH*

2015 - LADY TINA GREEN & PIETRO MINGARELLI POUR LALIQUE

73311300



7 640111 509448



GM / LS



CRISTAL INCOLORE - *CLEAR CRYSTAL*
LAQUÉ NOIR - *BLACK LACQUERED*
FRÈNE IVOIRE - *IVORY ASH*

2012 - LADY TINA GREEN & PIETRO MINGARELLI POUR LALIQUE

10180500



7 640111 493860

TABLES GIGOGNES - SIDE TABLES (NESTING TABLES)

RAISINS

ÉDITION NUMÉROTÉE / NUMBERED EDITION

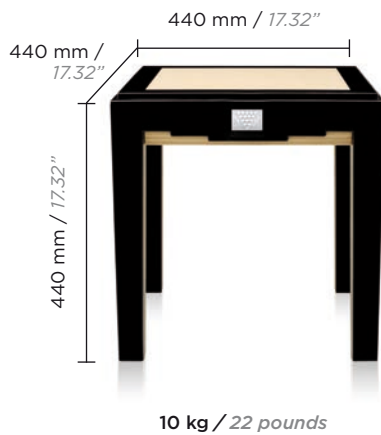

PM / SS

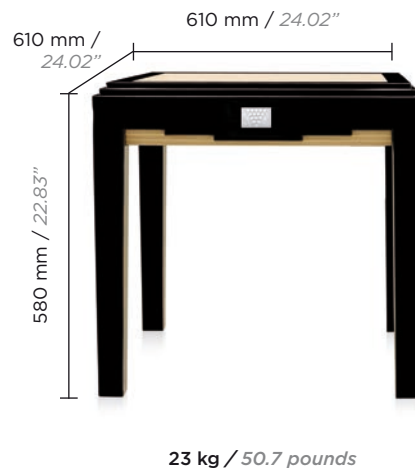

GM / LS

FINITION / FINISHING

REFERENCE

EAN CODE



CRISTAL INCOLORE - CLEAR CRYSTAL
LAQUÉ NOIR - BLACK LACQUERED
FRÊNE IVOIRE - IVORY ASH

10180400



PM / SS



CRISTAL INCOLORE - CLEAR CRYSTAL
LAQUÉ NOIR - BLACK LACQUERED
FRÊNE IVOIRE - IVORY ASH

10180300



GM / LS

2012 - LADY TINA GREEN & PIETRO MINGARELLI POUR LALIQUE

VITRINE - *DISPLAY UNIT*

DAHLIA

ÉDITION NUMÉROTÉE / *NUMBERED EDITION*



182 kg / 420.24 pounds

FINITION / *FINISHING*



CRISTAL INCOLORE - *CLEAR CRYSTAL*
LAQUÉ NOIR - *BLACK LACQUERED*
2 PORTES - *2 DOORS*

REFERENCE

72618310

EAN CODE



7 640163 972085

2016 - LADY TINA GREEN & PIETRO MINGARELLI POUR LALIQUE

ASSISES - SEATINGS



CANAPÉS CLASSIQUES - CLASSIC SOFAS

RAISINS



2200 mm / 86.61"

PM / SS

97 kg / 214 pounds



2600 mm / 102.36"

MM / MS

107 kg / 236 pounds





















3000 mm / 118.11"

GM / LS

CANAPÉS CLASSIQUES - CLASSIC SOFAS

RAISINS



FINITION / FINISHING		REFERENCE	EAN CODE
 PM / SS	 CRISTAL INCOLORE - <i>CLEAR CRYSTAL</i> SOIE IVOIRE - <i>IVORY SILK</i>	11293302	 7 640111 496366
	 CRISTAL INCOLORE - <i>CLEAR CRYSTAL</i> SOIE NOIRE - <i>BLACK SILK</i>	11293305	 7 640111 500155
	2012 - LADY TINA GREEN & PIETRO MINGARELLI POUR LALIQUE		
	 CRISTAL INCOLORE - <i>CLEAR CRYSTAL</i> CUIR IVOIRE - <i>IVORY LEATHER</i>	71102163	 7 640163 976090
 MM / MS	 CRISTAL INCOLORE - <i>CLEAR CRYSTAL</i> SOIE IVOIRE - <i>IVORY SILK</i>	11293301	 7 640111 500254
	 CRISTAL INCOLORE - <i>CLEAR CRYSTAL</i> SOIE NOIRE - <i>BLACK SILK</i>	11293304	 7 640111 500148
	2012 - LADY TINA GREEN & PIETRO MINGARELLI POUR LALIQUE		
	 CRISTAL INCOLORE - <i>CLEAR CRYSTAL</i> CHENILLE CRÈME - <i>CHENILLE HEAVY CREAM</i>	11293307	 7 640111 506881
 GM / LS	 CRISTAL INCOLORE - <i>CLEAR CRYSTAL</i> SOIE IVOIRE - <i>IVORY SILK</i>	11293300	 7 640111 496342
	 CRISTAL INCOLORE - <i>CLEAR CRYSTAL</i> SOIE NOIRE - <i>BLACK SILK</i>	11293303	 7 640111 500131
	2012 - LADY TINA GREEN & PIETRO MINGARELLI POUR LALIQUE		

CANAPÉS CONTEMPORAINS - *CONTEMPORARY SOFAS*

MASQUE DE FEMME



PM / SS

Soie noir / Black silk



PM / SS

97 kg / 213.40 pounds

Chenille ivoire / Chenille ivory

MASQUE DE FEMME



FINITION / FINISHING

REFERENCE

EAN CODE



CRISTAL INCOLORE - *CLEAR CRYSTAL*
CHENILLE IVOIRE - *CHENILLE IVORY*

10293910



2014 - LADY TINA GREEN & PIETRO MINGARELLI POUR LALIQUE



CRISTAL INCOLORE - *CLEAR CRYSTAL*
SOIE IVOIRE - *IVORY SILK*

10293900



CRISTAL INCOLORE - *CLEAR CRYSTAL*
SOIE NOIRE - *BLACK SILK*

10293901



2012 - LADY TINA GREEN & PIETRO MINGARELLI POUR LALIQUE



CRISTAL INCOLORE - *CLEAR CRYSTAL*
SOIE INDIGO - *INDIGO SILK*

10293902



CRISTAL INCOLORE - *CLEAR CRYSTAL*
VELOURS CLASSIQUE, COULEUR LIN
CLASSIC VELVET LINEN

71101121



CRISTAL INCOLORE - *CLEAR CRYSTAL*
CHENILLE CRÈME - *CHENILLE HEAVY CREAM*

71101112



CRISTAL INCOLORE - *CLEAR CRYSTAL*
CHENILLE CRÈME, CAPITONNÉ
CHENILLE HEAVY CREAM, DEEP QUILT

71101012



2015 - LADY TINA GREEN & PIETRO MINGARELLI POUR LALIQUE



CRISTAL INCOLORE - *CLEAR CRYSTAL*
VELOURS CLASSIQUE, COULEUR NOIR
CLASSIC VELVET, BLACK

71111123



2017 - LADY TINA GREEN & PIETRO MINGARELLI POUR LALIQUE



CRISTAL INCOLORE - *CLEAR CRYSTAL*
CHENILLE MEDLEY - *CHENILLE MEDLEY*

71101124



2018 - LADY TINA GREEN & PIETRO MINGARELLI POUR LALIQUE



PM / SS

CANAPÉS CONTEMPORAINS - *CONTEMPORARY SOFAS*

MASQUE DE FEMME



2600 mm / 102.36"

MM / MS

170 kg / 374 pounds

Chenille ivoire / *Chenille ivory*



3000 mm / 118.11"

GM / LS

Soie noir / *Black silk*

MASQUE DE FEMME



FINITION / FINISHING

REFERENCE

EAN CODE



CRISTAL INCOLORE - *CLEAR CRYSTAL*
SOIE IVOIRE - *IVORY SILK*

10294000



CRISTAL INCOLORE - *CLEAR CRYSTAL*
SOIE NOIRE - *BLACK SILK*

10294001



2012 - LADY TINA GREEN & PIETRO MINGARELLI POUR LALIQUE

7 640111 500100



CRISTAL INCOLORE - *CLEAR CRYSTAL*
VELOURS CLASSIQUE, COULEUR LIN
CLASSIC VELVET LINEN

71101221



CRISTAL INCOLORE - *CLEAR CRYSTAL*
VELOURS CLASSIQUE, COULEUR ÉBÈNE
CLASSIC VELVET, EBONY

71101223



CRISTAL INCOLORE - *CLEAR CRYSTAL*
CUIR IVOIRE - *IVORY LEATHER*

71101263



CRISTAL INCOLORE - *CLEAR CRYSTAL*
CUIR IMPRIMÉ CROCO IVOIRE
LEATHER PRINTED IVORY CROCO

71101264



2015 - LADY TINA GREEN & PIETRO MINGARELLI POUR LALIQUE

7 640163 975727



MM / MS



CRISTAL INCOLORE - *CLEAR CRYSTAL*
SOIE IVOIRE - *IVORY SILK*

10294100



CRISTAL INCOLORE - *CLEAR CRYSTAL*
SOIE NOIRE - *BLACK SILK*

10294101



2012 - LADY TINA GREEN & PIETRO MINGARELLI POUR LALIQUE

7 640111 500094



CRISTAL INCOLORE - *CLEAR CRYSTAL*
CHENILLE IVOIRE - *CHENILLE IVORY*

71101011



2014 - LADY TINA GREEN & PIETRO MINGARELLI POUR LALIQUE



CRISTAL INCOLORE - *CLEAR CRYSTAL*
VELOURS CLASSIQUE, COULEUR ÉBÈNE
CLASSIC VELVET, EBONY

71101319



2018 - LADY TINA GREEN & PIETRO MINGARELLI POUR LALIQUE

7 640182 870188



GM / LS

CANAPÉS CONTEMPORAINS - *CONTEMPORARY SOFAS*

RAISINS



2200 mm / 86.61"

PM / SS

97 kg / 213.40 pounds

FINITION / FINISHING

REFERENCE

EAN CODE



CRISTAL LUSTRÉ OR - *GOLD LUSTER CRYSTAL*
VELOUR VERT - *GREEN VELVET*

71102226



7 640182 870157

2018 - LADY TINA GREEN & PIETRO MINGARELLI POUR LALIQUE

CHAISES CONTEMPORAINES - CONTEMPORARY CHAIRS

MASQUE DE FEMME AVEC ACCOUDOIRS / WITH ARMRESTS



645 mm / 25.39"

620 mm / 24.41"

13 kg / 28.70 pounds

Soie ivoire / Ivory silk

Soie rouge / Red silk

FINITION / FINISHING

REFERENCE

EAN CODE



CRISTAL INCOLORE - CLEAR CRYSTAL
LAQUÉ NOIR - BLACK LACQUERED
SOIE IVOIRE - IVORY SILK

10294500



2012 - LADY TINA GREEN & PIETRO MINGARELLI POUR LALIQUE

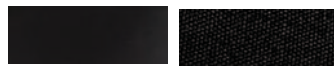

CRISTAL INCOLORE - CLEAR CRYSTAL
LAQUÉ NOIR - BLACK LACQUERED
SOIE NOIRE - BLACK SILK

71311516



CRISTAL INCOLORE - CLEAR CRYSTAL
LAQUÉ NOIR - BLACK LACQUERED
CUIR IMPRIMÉ CROCO NOIR - LEATHER PRINTED BLACK CROCO

11294550



2014 - LADY TINA GREEN & PIETRO MINGARELLI POUR LALIQUE



CRISTAL INCOLORE - CLEAR CRYSTAL
LAQUÉ NOIR - BLACK LACQUERED
CUIR IMPRIMÉ CROCO NOIR, CAPITONNÉ
LEATHER PRINTED BLACK CROCO, DEEP QUILT

71311562



CRISTAL INCOLORE - CLEAR CRYSTAL
LAQUÉ NOIR - BLACK LACQUERED
SOIE CRÈME, CAPITONNÉ - HEAVY CREAM SILK, DEEP QUILT

71311530



2015 - LADY TINA GREEN & PIETRO MINGARELLI POUR LALIQUE



CRISTAL INCOLORE - CLEAR CRYSTAL
LAQUÉ NOIR - BLACK LACQUERED
SOIE ROUGE - RED SILK

71311525



2017 - LADY TINA GREEN & PIETRO MINGARELLI POUR LALIQUE

7 640163 973570

CHAISES CONTEMPORAINES - CONTEMPORARY CHAIRS

MASQUE DE FEMME SANS ACCOUDOIR / WITHOUT ARMREST



Soie ivoire / Ivory silk











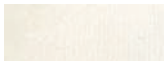







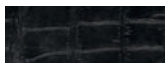



Soie rouge / Red silk

FINITION / FINISHING

REFERENCE

EAN CODE

		CRISTAL INCOLORE - CLEAR CRYSTAL LAQUÉ NOIR - BLACK LACQUERED SOIE IVOIRE - IVORY SILK	10294400	 7 640111 496298
2012 - LADY TINA GREEN & PIETRO MINGARELLI POUR LALIQUE				
		CRISTAL INCOLORE - CLEAR CRYSTAL LAQUÉ NOIR - BLACK LACQUERED SOIE INDIGO - INDIGO SILK	10294402	 7 640111 508687
		CRISTAL INCOLORE - CLEAR CRYSTAL LAQUÉ NOIR - BLACK LACQUERED SOIE CRÈME - HEAVY CREAM SILK	71311715	 7 640111 509189
		CRISTAL INCOLORE - CLEAR CRYSTAL LAQUÉ NOIR - BLACK LACQUERED CUIR IMPRIMÉ CROCO NOIR - LEATHER PRINTED BLACK CROCO	71311762	 7 640163 975314
		CRISTAL INCOLORE - CLEAR CRYSTAL LAQUÉ NOIR - BLACK LACQUERED SOIE CRÈME, CAPITONNÉ - HEAVY CREAM SILK, DEEP QUILT	71311730	 7 640163 976182
2015 - LADY TINA GREEN & PIETRO MINGARELLI POUR LALIQUE				
		CRISTAL INCOLORE - CLEAR CRYSTAL LAQUÉ NOIR - BLACK LACQUERED SOIE NOIRE - BLACK SILK	71311716	 7 640163 973204
		CRISTAL INCOLORE - CLEAR CRYSTAL LAQUÉ NOIR - BLACK LACQUERED VELOURS CLASSIQUE, COULEUR CRÈME - CLASSIC VELVET CREAM	71311722	 7 640163 972719
2016 - LADY TINA GREEN & PIETRO MINGARELLI POUR LALIQUE				
		CRISTAL INCOLORE - CLEAR CRYSTAL LAQUÉ NOIR - BLACK LACQUERED SOIE ROUGE - RED SILK	71311725	 7 640163 973587
2017 - LADY TINA GREEN & PIETRO MINGARELLI POUR LALIQUE				

CHAISES CONTEMPORAINES - *CONTEMPORARY CHAIRS*

RAISINS

AVEC ACCOUDOIRS / *WITH ARMRESTS*



FINITION / *FINISHING*

REFERENCE

EAN CODE



CRISTAL LUSTRÉ OR - *GOLD LUSTER CRYSTAL*
LAQUÉ VERT - *GREEN LACQUERED*
TISSU VERT - *GREEN FABRIC*

71372500



7 640182 870140

2018 - LADY TINA GREEN & PIETRO MINGARELLI POUR LALIQUE

CHAISES CLASSIQUES - CLASSIC CHAIRS

MASQUE DE FEMME AVEC ACCOUDOIRS / WITH ARMRESTS



20 kg / 44.1 pounds

FINITION / FINISHING

FINITION / FINISHING	REFERENCE	EAN CODE
 CRISTAL INCOLORE - CLEAR CRYSTAL LAQUÉ NOIR - BLACK LACQUERED SOIE IVOIRE - IVORY SILK 2013 - LADY TINA GREEN & PIETRO MINGARELLI POUR LALIQUE	10294700	 7 640111 496328
 CRISTAL INCOLORE - CLEAR CRYSTAL LAQUÉ NOIR - BLACK LACQUERED CUIR IMPRIMÉ CROCO NOIR - LEATHER PRINTED BLACK CROCO 2014 - LADY TINA GREEN & PIETRO MINGARELLI POUR LALIQUE	11294700	 7 640111 508922
 CRISTAL INCOLORE - CLEAR CRYSTAL LAQUÉ NOIR - BLACK LACQUERED SOIE NOIRE - BLACK SILK 2016 - LADY TINA GREEN & PIETRO MINGARELLI POUR LALIQUE	71311616	 7 640163 972726

CHAISES CLASSIQUES - CLASSIC CHAIRS

MASQUE DE FEMME SANS ACCOUDOIR / WITHOUT ARMREST



18,4 kg / 40.5 pounds

FINITION / FINISHING



CRISTAL INCOLORE - CLEAR CRYSTAL
LAQUÉ NOIR - BLACK LACQUERED
SOIE IVOIRE - IVORY SILK

REFERENCE

10294600

EAN CODE



2012 - LADY TINA GREEN & PIETRO MINGARELLI POUR LALIQUE



CRISTAL INCOLORE - CLEAR CRYSTAL
LAQUÉ NOIR - BLACK LACQUERED
SOIE NOIRE - BLACK SILK

71311816



CRISTAL INCOLORE - CLEAR CRYSTAL
LAQUÉ NOIR - BLACK LACQUERED
CUIR IMPRIMÉ CROCO NOIR - LEATHER PRINTED BLACK CROCO

11294600



2014 - LADY TINA GREEN & PIETRO MINGARELLI POUR LALIQUE



CRISTAL INCOLORE - CLEAR CRYSTAL
LAQUÉ NOIR - BLACK LACQUERED
VELOURS CLASSIQUE, COULEUR CRÈME - CLASSIC VELVET CREAM

71311822



2015 - LADY TINA GREEN & PIETRO MINGARELLI POUR LALIQUE

FAUTEUILS CONTEMPORAINS VILLA RENÉ LALIQUE

VILLA RENÉ LALIQUE CONTEMPORARY ARMCHAIRS

MASQUE DE FEMME AVEC ACCOUDOIRS / WITH ARMRESTS



Soie rouge / Red silk



20 kg / 44.1 pounds

Chenille medley / Chenille medley

FINITION / FINISHING

REFERENCE

EAN CODE



CRISTAL INCOLORE - CLEAR CRYSTAL
LAQUÉ NOIR - BLACK LACQUERED
CHENILLE MEDLEY - CHENILLE MEDLEY

71211024



2016 - LADY TINA GREEN & PIETRO MINGARELLI POUR LALIQUE



CRISTAL INCOLORE - CLEAR CRYSTAL
LAQUÉ NOIR - BLACK LACQUERED
SOIE ROUGE - RED SILK

71212025



2017 - LADY TINA GREEN & PIETRO MINGARELLI POUR LALIQUE

FAUTEUILS CONTEMPORAINS VILLA RENÉ LALIQUE

VILLA RENÉ LALIQUE CONTEMPORARY ARMCHAIRS

RAISINS

AVEC ACCOUDOIRS / WITH ARMRESTS



730 mm / 28.74"

20 kg / 44.1 pounds

FINITION / FINISHING

REFERENCE

EAN CODE



CRISTAL LUSTRÉ OR - GOLD LUSTER CRYSTAL
LAQUÉ VERT - GREEN LACQUERED
TISSU VERT - GREEN FABRIC

71272027



7 640182 870164

2018 - LADY TINA GREEN & PIETRO MINGARELLI POUR LALIQUE

CHAISES DE BAR - *BARSTOOL*

MASQUE DE FEMME SANS ACCOUDOIR / *WITHOUT ARMREST*



13 kg / 28.70 pounds

FINITION / *FINISHING*

REFERENCE

EAN CODE



CRISTAL INCOLORE - *CLEAR CRYSTAL*
LAQUÉ NOIR - *BLACK LACQUERED*
CUIR IMPRIMÉ CROCO NOIR - *LEATHER PRINTED BLACK CROCO*

71511362



7 640163 972139











2016 - LADY TINA GREEN & PIETRO MINGARELLI POUR LALIQUE

FAUTEUILS CLUB CLASSIQUES - CLASSIC CLUB ARMCHAIRS

RAISINS



39 kg / 86 pounds

FINITION / FINISHING	REFERENCE	EAN CODE
 CRISTAL INCOLORE - CLEAR CRYSTAL SOIE IVOIRE - IVORY SILK	10293800	 7 640111 496229
 CRISTAL INCOLORE - CLEAR CRYSTAL SOIE NOIRE - BLACK SILK	10293801	 7 640111 500162
2012 - LADY TINA GREEN & PIETRO MINGARELLI POUR LALIQUE		
 CRISTAL INCOLORE - CLEAR CRYSTAL SOIE CRÈME - HEAVY CREAM SILK	71202015	 7 640111 509165
 CRISTAL INCOLORE - CLEAR CRYSTAL CUIR IVOIRE - IVORY LEATHER	71202063	 7 640163 975178
 CRISTAL INCOLORE - CLEAR CRYSTAL CUIR IMPRIMÉ CROCO IVOIRE LEATHER PRINTED IVORY CROCO	71202064	 7 640163 975734

2015 - LADY TINA GREEN & PIETRO MINGARELLI POUR LALIQUE

FAUTEUILS CLUB CONTEMPORAINS - CONTEMPORARY CLUB ARMCHAIRS

MASQUE DE FEMME



1040 mm / 40.94"

61 kg / 134.50 pounds



Velour classique, couleur ébène / Classic velvet ebony



CAPITONNÉ / DEEP QUILT

Chenille crème / Chenille cream

FINITION / FINISHING

	REFERENCE	EAN CODE
 CRISTAL INCOLORE - CLEAR CRYSTAL SOIE IVOIRE - IVORY SILK	10293700	7 640111 496212
 CRISTAL INCOLORE - CLEAR CRYSTAL SOIE NOIRE - BLACK SILK	10293701	7 640111 500124

2012 - LADY TINA GREEN & PIETRO MINGARELLI POUR LALIQUE

 CRISTAL INCOLORE - CLEAR CRYSTAL VELOURS CLASSIQUE, COULEUR LIN CLASSIC VELVET LINEN	71201021	7 640111 509585
 CRISTAL INCOLORE - CLEAR CRYSTAL VELOURS CLASSIQUE, COULEUR ÉBÈNE CLASSIC VELVET EBONY	71201023	7 640163 975307
 CRISTAL INCOLORE - CLEAR CRYSTAL CUIR IMPRIMÉ CROCO NOIR LEATHER PRINTED BLACK CROCO	71201062	7 640163 975505
 CRISTAL INCOLORE - CLEAR CRYSTAL CHENILLE CRÈME CHENILLE HEAVY CREAM	71201012	7 640163 976113

2015 - LADY TINA GREEN & PIETRO MINGARELLI POUR LALIQUE

 CRISTAL INCOLORE - CLEAR CRYSTAL CHENILLE IVOIRE CHENILLE IVORY	71201011	7 640163 973198
---	----------	-----------------

2016 - LADY TINA GREEN & PIETRO MINGARELLI POUR LALIQUE

 CRISTAL INCOLORE - CLEAR CRYSTAL CHENILLE CRÈME, CAPITONNÉ CHENILLE CREAM, DEEP QUILT	71201412	7 640163 974508
---	----------	-----------------

2017 - LADY TINA GREEN & PIETRO MINGARELLI POUR LALIQUE

FAUTEUILS - ARMCHAIRS

LONGCHAMP

ÉDITION NUMÉROTÉE / NUMBERED EDITION



Finition cuir imprimé croco noir. /
Leather fabric printed black croco.



730 mm / 28.74"

30 kg / 66 pounds

FINITION / FINISHING

REFERENCE

EAN CODE



CRISTAL INCOLORE - CLEAR CRYSTAL
LAQUÉ NOIR - BLACK LACQUERED
SOIE IVOIRE - IVORY SILK

11294802



2013 - LADY TINA GREEN & PIETRO MINGARELLI POUR LALIQUE



CRISTAL INCOLORE - CLEAR CRYSTAL
LAQUÉ NOIR - BLACK LACQUERED
CUIR IMPRIMÉ CROCO NOIR - LEATHER PRINTED BLACK CROCO

11294850



2014 - LADY TINA GREEN & PIETRO MINGARELLI POUR LALIQUE

FAUTEUILS - *ARMCHAIRS*

PANTHÈRE

ÉDITION NUMÉROTÉE / *NUMBERED EDITION*

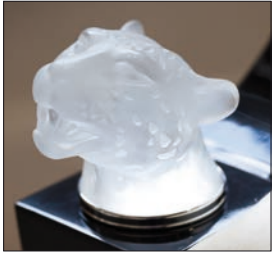

30 kg / 66 pounds

FINITION / *FINISHING*

REFERENCE

EAN CODE

  CRISTAL INCOLORE - *CLEAR CRYSTAL*
LAQUÉ NOIR - *BLACK LACQUERED*
SOIE IVOIRE - *IVORY SILK*

11294801



2012 - LADY TINA GREEN & PIETRO MINGARELLI POUR LALIQUE

  CRISTAL INCOLORE - *CLEAR CRYSTAL*
LAQUÉ NOIR - *BLACK LACQUERED*
CUIR IVOIRE - *IVORY LEATHER*

71318063



2015 - LADY TINA GREEN & PIETRO MINGARELLI POUR LALIQUE

FAUTEUILS - ARMCHAIRS

VICTOIRE



















ÉDITION NUMÉROTÉE / NUMBERED EDITION

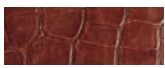

FINITION / FINISHING

REFERENCE

EAN CODE

		CRISTAL INCOLORE - CLEAR CRYSTAL LAQUÉ NOIR - BLACK LACQUERED SOIE IVOIRE - IVORY SILK	10294800	 7 640111 496335
2011 - LADY TINA GREEN & PIETRO MINGARELLI POUR LALIQUE				
		CRISTAL INCOLORE - CLEAR CRYSTAL LAQUÉ NOIR - BLACK LACQUERED CHENILLE IVOIRE - IVORY CHENILLE	10294810	 7 640111 506232
2013 - LADY TINA GREEN & PIETRO MINGARELLI POUR LALIQUE				
		CRISTAL INCOLORE - CLEAR CRYSTAL LAQUÉ NOIR - BLACK LACQUERED CUIR IMPRIMÉ CROCO NOIR - LEATHER PRINTED BLACK CROCO	10294850	 7 640111 508670
2013 - LADY TINA GREEN & PIETRO MINGARELLI POUR LALIQUE				
		CRISTAL INCOLORE - CLEAR CRYSTAL LAQUÉ NOIR - BLACK LACQUERED VELOURS CLASSIQUE, COULEUR CRÈME - CLASSIC VELVET CREAM	71216022	 7 640111 509608
		CRISTAL INCOLORE - CLEAR CRYSTAL LAQUÉ NOIR - BLACK LACQUERED CUIR IVOIRE - IVORY LEATHER	71216063	 7 640163 975604
		CRISTAL INCOLORE - CLEAR CRYSTAL LAQUÉ NOIR - BLACK LACQUERED CUIR SOFIA CHOCOLAT - SOFIA CHOCOLATE LEATHER	71316066	 7 640163 975710
2015 - LADY TINA GREEN & PIETRO MINGARELLI POUR LALIQUE				
		CRISTAL INCOLORE - CLEAR CRYSTAL LAQUÉ VERT - GREEN LACQUERED VELOURS VERT - GREEN VELVET	71276032	 7 640182 871352
2018 - LADY TINA GREEN & PIETRO MINGARELLI POUR LALIQUE				

MASQUE DE FEMME

ÉDITION NUMÉROTÉE / NUMBERED EDITION

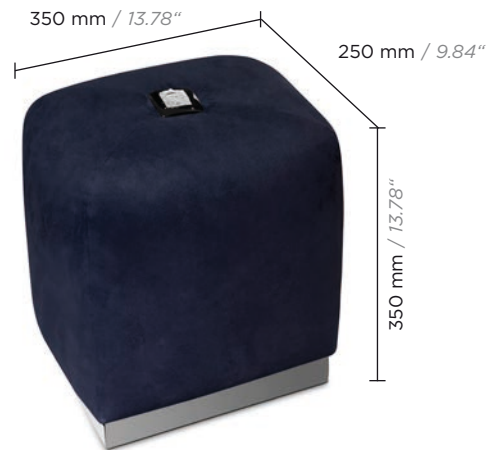

PM / SS
4 kg / 8.82 pounds
Soie noire / Black silk



MM / MS
34 kg / 75 pounds
Soie ivoire / Ivory silk



GM / LS
97 kg / 210 pounds
Cuir imprimé croco noir / Leather fabric printed black croco

MASQUE DE FEMME

ÉDITION NUMÉROTÉE / NUMBERED EDITION



FINITION / FINISHING

REFERENCE

EAN CODE



PM / SS



CRISTAL INCOLORE - *CLEAR CRYSTAL*
LAQUÉ NOIR - *BLACK LACQUERED*
SOIE NOIRE - *BLACK SILK*

71401116



7 640111 494416

2016 - LADY TINA GREEN & PIETRO MINGARELLI POUR LALIQUE

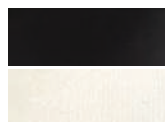

CRISTAL INCOLORE - *CLEAR CRYSTAL*
LAQUÉ NOIR - *BLACK LACQUERED*
SOIE IVOIRE - *IVORY SILK*

10180800



7 640111 496267



CRISTAL INCOLORE - *CLEAR CRYSTAL*
LAQUÉ NOIR - *BLACK LACQUERED*
CUIR IVOIRE - *IVORY LEATHER*

10180700



7 640111 494058

2012 - LADY TINA GREEN & PIETRO MINGARELLI POUR LALIQUE



MM / MS

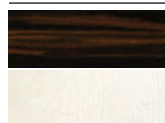

CRISTAL INCOLORE - *CLEAR CRYSTAL*
ÉBÈNE NATUREL - *NATURAL EBONY*
SOIE IVOIRE - *IVORY SILK*

10180801



7 640111 508731

2014 - LADY TINA GREEN & PIETRO MINGARELLI POUR LALIQUE



CRISTAL INCOLORE - *CLEAR CRYSTAL*
BLEU EUCALYPTUS - *BLUE EUCALYPTUS*
SOIE INDIGO - *INDIGO SILK*

71451018



7 640163 976205



CRISTAL INCOLORE - *CLEAR CRYSTAL*
BLEU EUCALYPTUS - *BLUE EUCALYPTUS*
CUIR IMPRIMÉ CROCO NOIR
LEATHER PRINTED BLACK CROCO

71451062



7 640163 975123

2015 - LADY TINA GREEN & PIETRO MINGARELLI POUR LALIQUE



CRISTAL INCOLORE - *CLEAR CRYSTAL*
BLEU EUCALYPTUS - *BLUE EUCALYPTUS*
CUIR IMPRIMÉ CROCO IVOIRE -
LEATHER PRINTED IVORY CROCO

71451064



7 640163 972863

2016 - LADY TINA GREEN & PIETRO MINGARELLI POUR LALIQUE



GM / LS



CRISTAL INCOLORE - *CLEAR CRYSTAL*
SOIE IVOIRE - *IVORY SILK*

10294300



7 640111 496281



CRISTAL INCOLORE - *CLEAR CRYSTAL*
CUIR IMPRIMÉ CROCO NOIR
LEATHER PRINTED BLACK CROCO

10294200



7 640111 496274

2012 - LADY TINA GREEN & PIETRO MINGARELLI POUR LALIQUE



CRISTAL INCOLORE - *CLEAR CRYSTAL*
CUIR IMPRIMÉ CROCO IVOIRE
LEATHER PRINTED IVORY CROCO

71401361



7 640182 870287

2018 - LADY TINA GREEN & PIETRO MINGARELLI POUR LALIQUE

OTTOMANS - OTTOMANS

RAISINS

ÉDITION NUMÉROTÉE / NUMBERED EDITION



PM CARRÉ / SS, SQUARE

15 kg / 33.10 pounds

Soie ivoire / Ivory silk



Tissu vert / Green fabric

FINITION / FINISHING

REFERENCE

EAN CODE

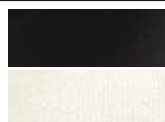

CRISTAL INCOLORE - CLEAR CRYSTAL
LAQUÉ NOIR - BLACK LACQUERED
SOIE IVOIRE - IVORY SILK

10180900



7 640111 508298

2013 - LADY TINA GREEN & PIETRO MINGARELLI POUR LALIQUE

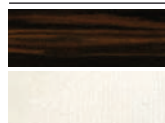

CRISTAL INCOLORE - CLEAR CRYSTAL
ÉBÈNE NATUREL - NATURAL EBONY
SOIE IVOIRE - IVORY SILK

10180910



7 640111 508601

2014 - LADY TINA GREEN & PIETRO MINGARELLI POUR LALIQUE



CRISTAL INCOLORE - CLEAR CRYSTAL
LAQUÉ NOIR - BLACK LACQUERED
CUIR IVOIRE - IVORY LEATHER

71412163



7 640163 976151



PM CARRÉ / SS, SQUARE



CRISTAL INCOLORE - CLEAR CRYSTAL
LAQUÉ NOIR - BLACK LACQUERED
SOIE INDIGO - INDIGO SILK

10180912



7 640111 508717



CRISTAL INCOLORE - CLEAR CRYSTAL
LAQUÉ NOIR - BLACK LACQUERED
CHENILLE CRÈME - CHENILLE HEAVY CREAM

71412112



7 640163 976168



CRISTAL INCOLORE - CLEAR CRYSTAL
FRÈNE IVOIRE - IVORY ASH
SOIE IVOIRE - IVORY SILK

71442014



7 640163 975482

2015 - LADY TINA GREEN & PIETRO MINGARELLI POUR LALIQUE

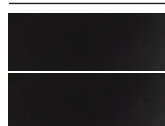

CRISTAL INCOLORE - CLEAR CRYSTAL
LAQUÉ NOIR - BLACK LACQUERED
SOIE NOIR - BLACK SILK

71412116



7 640163 973693



CRISTAL LUSTRÉ OR - GOLD LUSTER CRYSTAL
CHÈNE SPÉCIAL - SPECIAL OAK
BOIS NATUREL - NATURAL WOOD
TISSU VERT - GREEN FABRIC

71492110



7 640182 870133

2018 - LADY TINA GREEN & PIETRO MINGARELLI POUR LALIQUE

OTTOMANS - OTTOMANS

RAISINS

ÉDITION NUMÉROTÉE / NUMBERED EDITION



MM / MS

34 kg / 75 pounds

FINITION / FINISHING

REFERENCE

EAN CODE

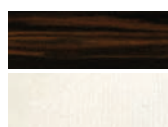

CRISTAL INCOLORE - CLEAR CRYSTAL
ÉBÈNE NATUREL - NATURAL EBONY
SOIE IVOIRE - IVORY SILK

10180810



2013 - LADY TINA GREEN & PIETRO MINGARELLI POUR LALIQUE

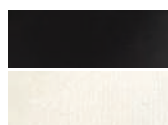

CRISTAL INCOLORE - CLEAR CRYSTAL
LAQUÉ NOIR - BLACK LACQUERED
SOIE IVOIRE - IVORY SILK

71412014



CRISTAL INCOLORE - CLEAR CRYSTAL
ÉBÈNE NATUREL - NATURAL EBONY
SOIE INDIGO - INDIGO SILK

10180812



2014 - LADY TINA GREEN & PIETRO MINGARELLI POUR LALIQUE

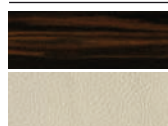

CRISTAL INCOLORE - CLEAR CRYSTAL
ÉBÈNE NATUREL - NATURAL EBONY
CUIR IVOIRE - IVORY LEATHER

71422063



MM / MS

2015 - LADY TINA GREEN & PIETRO MINGARELLI POUR LALIQUE

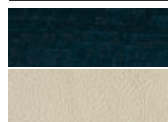

CRISTAL INCOLORE - CLEAR CRYSTAL
BLEU EUCALYPTUS - BLUE EUCALYPTUS
CUIR IVOIRE - IVORY LEATHER

71452063



CRISTAL INCOLORE - CLEAR CRYSTAL
BLEU EUCALYPTUS - BLUE EUCALYPTUS
CUIR CROCO IVOIRE - LEATHER IVORY CROCO

71452064



CRISTAL INCOLORE - CLEAR CRYSTAL
ÉBÈNE NATUREL - NATURAL EBONY
CUIR CROCO IVOIRE - LEATHER IVORY CROCO

71422064



2018 - LADY TINA GREEN & PIETRO MINGARELLI POUR LALIQUE

AUTRE MOBILIER - *OTHER FURNITURE*



LITS - BEDS

MASQUE DE FEMME

ÉDITION NUMÉROTÉE / *NUMBERED EDITION*



2280 mm / 89.76"

116 kg / 255.74 pounds

MM / MS

Laqué noir - soie ivoire / *Black lacquered - ivory silk*



2480 mm / 97.64"

171 kg / 377 pounds

GM / LS

Frêne ivoire - soie ivoire / *Ivory ash - ivory silk*

FINITION / *FINISHING*

REFERENCE

EAN CODE



CRISTAL INCOLORE - *CLEAR CRYSTAL*
FRÊNE IVOIRE - *IVORY ASH*
SOIE IVOIRE - *IVORY SILK*

10183500



7 640111 494188

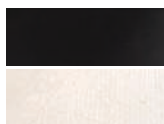

CRISTAL INCOLORE - *CLEAR CRYSTAL*
LAQUÉ NOIR - *BLACK LACQUERED*
SOIE IVOIRE - *IVORY SILK*

10183300



7 640111 494140

MM / MS
Matelas 180 x 200 cm
Mattress 180 x 200 cm



CRISTAL INCOLORE - *CLEAR CRYSTAL*
FRÊNE IVOIRE - *IVORY ASH*
SOIE IVOIRE - *IVORY SILK*

10183900



7 640111 494287

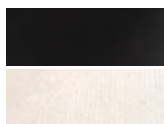

CRISTAL INCOLORE - *CLEAR CRYSTAL*
LAQUÉ NOIR - *BLACK LACQUERED*
SOIE IVOIRE - *IVORY SILK*

10183700



7 640111 494195

GM / LS
Matelas 200 x 200 cm
Mattress 200 x 200 cm

2011 - LADY TINA GREEN & PIETRO MINGARELLI POUR LALIQUE

Lit et tête de lit livrés sans matelas, ni sommier. / *Bedframe and head-board delivered without mattress neither bedbase.*

LITS - BEDS

RAISINS

ÉDITION NUMÉROTÉE / NUMBERED EDITION



2140 mm / 84.25"

1600 mm / 62.99"

2280 mm / 89.76"

116 kg / 255.74 pounds

MM / MS

Laqué noir - soie ivoire / Black lacquered - ivory silk



2140 mm / 84.25"

1600 mm / 62.99"

2480 mm / 97.64"

171 kg / 377 pounds

GM / LS

Bois naturel - tissu vert / Natural wood - green fabric

FINITION / FINISHING

REFERENCE

EAN CODE



CRISTAL INCOLORE - CLEAR CRYSTAL
FRÈNE IVOIRE - IVORY ASH
SOIE IVOIRE - IVORY SILK

10181500



7 640111 494089

MM / MS
Matelas 180 x 200 cm
Mattress 180 x 200 cm

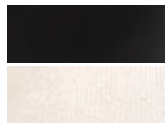

CRISTAL INCOLORE - CLEAR CRYSTAL
LAQUÉ NOIR - BLACK LACQUERED
SOIE IVOIRE - IVORY SILK

10181300



7 640111 505358



CRISTAL INCOLORE - CLEAR CRYSTAL
FRÈNE IVOIRE - IVORY ASH
SOIE IVOIRE - IVORY SILK

10181900



7 640111 494102

GM / LS
Matelas 200 x 200 cm
Mattress 200 x 200 cm

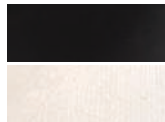

CRISTAL INCOLORE - CLEAR CRYSTAL
LAQUÉ NOIR - BLACK LACQUERED
SOIE IVOIRE - IVORY SILK

10181700



7 640111 494096

2011 - LADY TINA GREEN & PIETRO MINGARELLI POUR LALIQUE



CRISTAL LUSTRÉ OR - GOLD LUSTER CRYSTAL
BOIS NATUREL - NATURAL WOOD
TISSU VERT - GREEN FABRIC

74162100



7 640182 870003

2018 - LADY TINA GREEN & PIETRO MINGARELLI POUR LALIQUE

Lit et tête de lit livrés sans matelas, ni sommier. / Bedframe and head-board delivered without mattress neither bedbase.

CADRES TV - TV FRAMES SURROUND

RAISINS

ÉDITION NUMÉROTÉE / NUMBERED EDITION

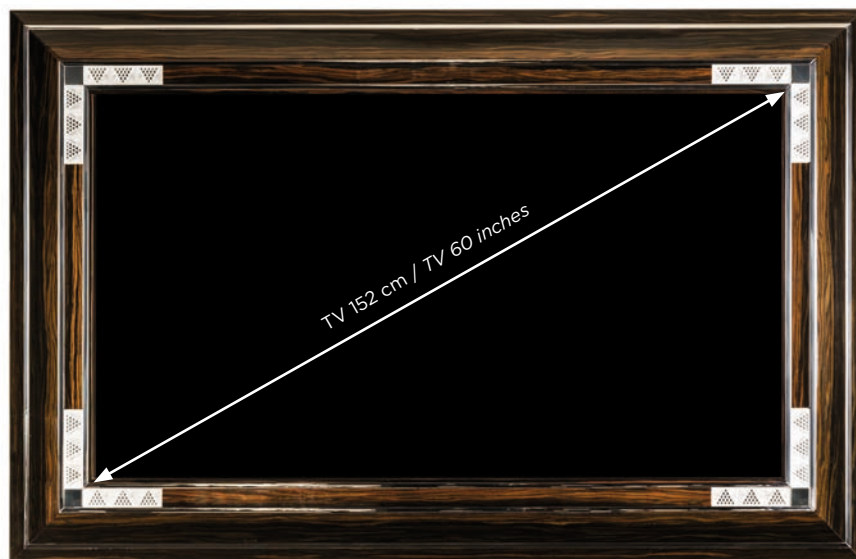

50 kg / 110.20 pounds

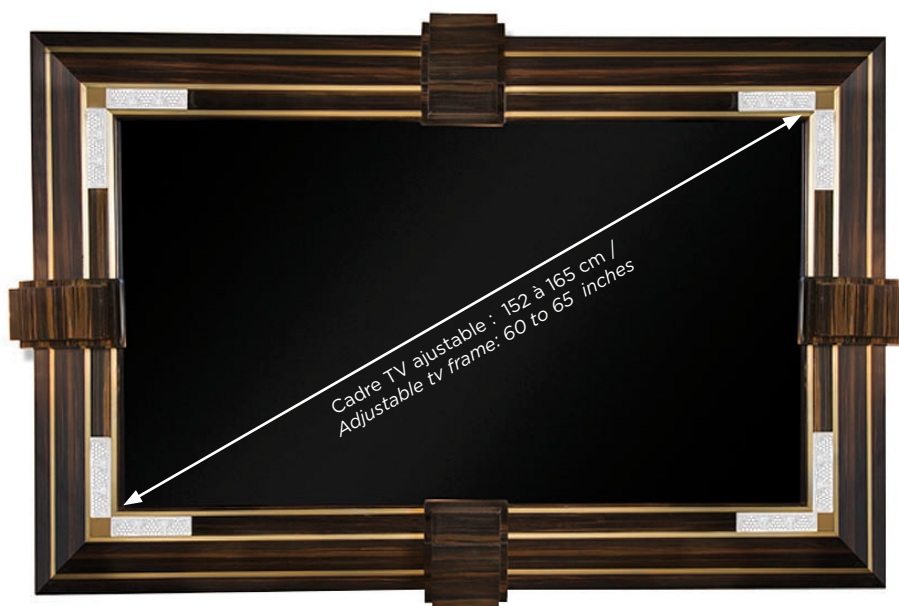

FINITION / FINISHING

REFERENCE

EAN CODE



CRISTAL INCOLORE - CLEAR CRYSTAL
ÉBÈNE NATUREL - NATURAL EBONY

11186000



7 640111 506652

2013 - LADY TINA GREEN & PIETRO MINGARELLI POUR LALIQUE

Pour TV de 60". Modèle de TV à spécifier lors de la commande. / For 60" TV. Precise the TV dimensions when ordering.



CRISTAL INCOLORE - CLEAR CRYSTAL
LAQUÉ NOIR - BLACK LACQUERED

75212000



7 640163 972078

2016 - LADY TINA GREEN & PIETRO MINGARELLI POUR LALIQUE

Pour TV de 60". Modèle de TV à spécifier lors de la commande. / For 60" TV. Precise the TV dimensions when ordering.

CADRE TV ADAPTABLE - TV FRAME SURROUND ADJUSTABLE



CRISTAL INCOLORE - CLEAR CRYSTAL
ÉBÈNE NATUREL - NATURAL EBONY
ACIER DORÉ - INOX GOLDEN SATIN STEEL

75222002



7 640163 974607

2015 - LADY TINA GREEN & PIETRO MINGARELLI POUR LALIQUE

MASQUE DE FEMME

ÉDITION NUMÉROTÉE / *NUMBERED EDITION*



1480 mm / 58.27"

960 mm / 37.80"

18 kg / 39.7 pounds

FINITION / *FINISHING*

REFERENCE

EAN CODE



CRISTAL INCOLORE - *CLEAR CRYSTAL*
FRÊNE IVOIRE - *IVORY ASH*

11185400



2011 - LADY TINA GREEN & PIETRO MINGARELLI POUR LALIQUE



CRISTAL INCOLORE - *CLEAR CRYSTAL*
LAQUÉ NOIR - *BLACK LACQUERED*

10185400



2012 - LADY TINA GREEN & PIETRO MINGARELLI POUR LALIQUE



CRISTAL INCOLORE - *CLEAR CRYSTAL*
ÉBÈNE NATUREL - *NATURAL EBONY*

75121000



2015 - LADY TINA GREEN & PIETRO MINGARELLI POUR LALIQUE

MIROIRS - *MIRRORS*

RAISINS



45 kg / 99.20 pounds



45 kg / 99.20 pounds

FINITION / FINISHING

REFERENCE

EAN CODE



PM / SS



CRISTAL LUSTRÉ OR - GOLD LUSTER CRYSTAL
BOIS NATUREL - NATURAL WOOD

75153406



7 640182 870065



GM / LS



CRISTAL LUSTRÉ OR - GOLD LUSTER CRYSTAL
BOIS NATUREL - NATURAL WOOD

75153006



7 640182 870072

2018 - LADY TINA GREEN & PIETRO MINGARELLI POUR LALIQUE



1380 mm / 54.33"

960 mm / 37.80"

45 kg / 99.20 pounds

Laqué noir - Acier doré / Black lacquered - inox golden satin steel



1750 mm / 68.90"

960 mm / 37.80"

Laqué noir / Black lacquered

FINITION / FINISHING

REFERENCE

EAN CODE



CRISTAL INCOLORE - CLEAR CRYSTAL
LAQUÉ NOIR - BLACK LACQUERED

10185300



CRISTAL INCOLORE - CLEAR CRYSTAL
FRÊNE IVOIRE - IVORY ASH

11185300



2012 - LADY TINA GREEN & PIETRO MINGARELLI POUR LALIQUE

L1380 x 1960 mm
L54.33" x W37.80"



CRISTAL INCOLORE - CLEAR CRYSTAL
ÉBÈNE NATUREL - NATURAL EBONY

75122000



2015 - LADY TINA GREEN & PIETRO MINGARELLI POUR LALIQUE



CRISTAL INCOLORE - CLEAR CRYSTAL
LAQUÉ NOIR - BLACK LACQUERED
ACIER DORÉ - INOX GOLDEN SATIN STEEL

75103401



2016 - LADY TINA GREEN & PIETRO MINGARELLI POUR LALIQUE

L1750 x 1960 mm
L68.90" x W37.80"



CRISTAL INCOLORE - CLEAR CRYSTAL
LAQUÉ NOIR - BLACK LACQUERED

75112300



2015 - LADY TINA GREEN & PIETRO MINGARELLI POUR LALIQUE

RAISINS

COURBÉ / *CURVED*

ÉDITION NUMÉROTÉE / *NUMBERED EDITION*



FINITION / *FINISHING*

REFERENCE

EAN CODE



CRISTAL INCOLORE - *CLEAR CRYSTAL*
LAQUÉ NOIR - *BLACK LACQUERED*

75103130



2017 - LADY TINA GREEN & PIETRO MINGARELLI POUR LALIQUE



FINITION / FINISHING



CRISTAL INCOLORE - CLEAR CRYSTAL
LAQUÉ NOIR - BLACK LACQUERED

REFERENCE

10185501

EAN CODE



CRISTAL INCOLORE - CLEAR CRYSTAL
BLEU EUCALYPTUS - BLUE EUCALYPTUS

75150000



CRISTAL INCOLORE - CLEAR CRYSTAL
ÉBÈNE NATUREL - NATURAL EBONY

11185500



CRISTAL INCOLORE - CLEAR CRYSTAL
FRÈNE IVOIRE - IVORY ASH

75144000



2014 - LADY TINA GREEN & PIETRO MINGARELLI POUR LALIQUE

TIANLONG



Photo non contractuelle / *Non contractual picture*

FINITION / *FINISHING*

REFERENCE

EAN CODE



CRISTAL INCOLORE - *CLEAR CRYSTAL*
LAQUÉ NOIR - *BLACK LACQUERED*
ACIER DORÉ - *INOX GOLDEN SATIN STEEL*

75115001



2015 - LADY TINA GREEN & PIETRO MINGARELLI POUR LALIQUE

LINGE DE MAISON - *SOFT FURNISHING*



COUSSINS BRODÉS - EMBROIDERED CUSHIONS

2 POISSONS / KOI CIRCLE



CARRÉ / SQUARE













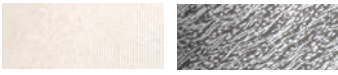
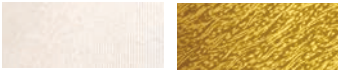



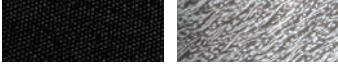
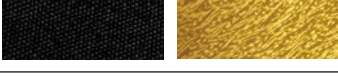

RECTANGULAIRE / RECTANGULAR

FINITION / FINISHING

REFERENCE

EAN CODE





















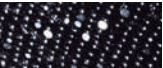

FINITION / FINISHING	REFERENCE	EAN CODE
 <p>CARRÉ SQUARE</p> <p>500x500 mm 19.68" x 19.68"</p>	 <p>SOIE IVOIRE - <i>IVORY SILK</i> BRODÉ NOIR - <i>BLACK EMBROIDERY</i></p>	11602110 7 640111 504689
	 <p>SOIE IVOIRE - <i>IVORY SILK</i> BRODÉ ARGENT - <i>SILVER EMBROIDERY</i></p>	11602120 7 640111 504696
	 <p>SOIE IVOIRE - <i>IVORY SILK</i> BRODÉ OR - <i>GOLD EMBROIDERY</i></p>	11602130 7 640111 504702
	 <p>SOIE PLATINE - <i>PLATINUM SILK</i> BRODÉ NOIR - <i>BLACK EMBROIDERY</i></p>	11602140 7 640111 504719
	 <p>SOIE PLATINE - <i>PLATINUM SILK</i> BRODÉ ARGENT - <i>SILVER EMBROIDERY</i></p>	11602150 7 640111 504726
	 <p>SOIE PLATINE - <i>PLATINUM SILK</i> BRODÉ OR - <i>GOLD EMBROIDERY</i></p>	11602160 7 640111 504733
	 <p>SOIE NOIRE - <i>BLACK SILK</i> BRODÉ ARGENT - <i>SILVER EMBROIDERY</i></p>	11602170 7 640111 504740
	 <p>SOIE NOIRE - <i>BLACK SILK</i> BRODÉ OR - <i>GOLD EMBROIDERY</i></p>	11602180 7 640111 504757
 <p>RECTANGULAIRE RECTANGULAR</p> <p>560 x 400 mm 22.04" x 15.74"</p>	 <p>SOIE IVOIRE - <i>IVORY SILK</i> BRODÉ NOIR - <i>BLACK EMBROIDERY</i></p>	11602210 7 640111 504764
	 <p>SOIE IVOIRE - <i>IVORY SILK</i> BRODÉ ARGENT - <i>SILVER EMBROIDERY</i></p>	11602220 7 640111 504771
	 <p>SOIE IVOIRE - <i>IVORY SILK</i> BRODÉ OR - <i>GOLD EMBROIDERY</i></p>	11602230 7 640111 504788
	 <p>SOIE PLATINE - <i>PLATINUM SILK</i> BRODÉ NOIR - <i>BLACK EMBROIDERY</i></p>	11602240 7 640111 504795
	 <p>SOIE PLATINE - <i>PLATINUM SILK</i> BRODÉ ARGENT - <i>SILVER EMBROIDERY</i></p>	11602250 7 640111 504801
	 <p>SOIE PLATINE - <i>PLATINUM SILK</i> BRODÉ OR - <i>GOLD EMBROIDERY</i></p>	11602260 7 640111 504818
	 <p>SOIE NOIRE - <i>BLACK SILK</i> BRODÉ ARGENT - <i>SILVER EMBROIDERY</i></p>	11602270 7 640111 504825
	 <p>SOIE NOIRE - <i>BLACK SILK</i> BRODÉ OR - <i>GOLD EMBROIDERY</i></p>	11602280 7 640111 504832

2011 - LADY TINA GREEN & PIETRO MINGARELLI POUR LALIQUE

COUSSINS PERLÉS - *BEADED CUSHIONS*

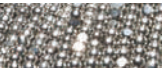
CHEVAL BONDISSANT / *LEAPING HORSE*











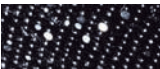







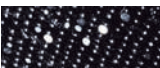



FINITION / FINISHING		REFERENCE	EAN CODE
		SOIE IVOIRE - <i>IVORY SILK</i> PERLÉ NOIR - <i>BLACK GLASS BEADS</i>	11603310 
		SOIE IVOIRE - <i>IVORY SILK</i> PERLÉ ARGENT - <i>SILVER GLASS BEADS</i>	11603320 
		SOIE IVOIRE - <i>IVORY SILK</i> PERLÉ OR - <i>GOLD GLASS BEADS</i>	11603330 
		SOIE PLATINE - <i>PLATINUM SILK</i> PERLÉ NOIR - <i>BLACK GLASS BEADS</i>	11603340 
		SOIE PLATINE - <i>PLATINUM SILK</i> PERLÉ ARGENT - <i>SILVER GLASS BEADS</i>	11603350 
		SOIE PLATINE - <i>PLATINUM SILK</i> PERLÉ OR - <i>GOLD GLASS BEADS</i>	11603360 
		SOIE NOIRE - <i>BLACK SILK</i> PERLÉ ARGENT - <i>SILVER GLASS BEADS</i>	11603370 
		SOIE NOIRE - <i>BLACK SILK</i> PERLÉ OR - <i>GOLD GLASS BEADS</i>	11603380 

COUSSINS PERLÉS - *BEADED CUSHIONS*

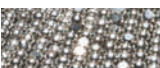
CHEVAL DEBOUT / *STANDING HORSE*



FINITION / FINISHING			REFERENCE	EAN CODE
		SOIE IVOIRE - <i>IVORY SILK</i> PERLÉ NOIR - <i>BLACK GLASS BEADS</i>	11603210	 7 640111 505006
		SOIE IVOIRE - <i>IVORY SILK</i> PERLÉ ARGENT - <i>SILVER GLASS BEADS</i>	11603220	 7 640111 505013
		SOIE IVOIRE - <i>IVORY SILK</i> PERLÉ OR - <i>GOLD GLASS BEADS</i>	11603230	 7 640111 505020
		SOIE PLATINE - <i>PLATINUM SILK</i> PERLÉ NOIR - <i>BLACK GLASS BEADS</i>	11603240	 7 640111 505037
		SOIE PLATINE - <i>PLATINUM SILK</i> PERLÉ ARGENT - <i>SILVER GLASS BEADS</i>	11603250	 7 640111 505044
		SOIE PLATINE - <i>PLATINUM SILK</i> PERLÉ OR - <i>GOLD GLASS BEADS</i>	11603260	 7 640111 505051
		SOIE NOIRE - <i>BLACK SILK</i> PERLÉ ARGENT - <i>SILVER GLASS BEADS</i>	11603270	 7 640111 505068
		SOIE NOIRE - <i>BLACK SILK</i> PERLÉ OR - <i>GOLD GLASS BEADS</i>	11603280	 7 640111 505075

2011 - LADY TINA GREEN & PIETRO MINGARELLI POUR LALIQUE

COUSSINS PERLÉS - *BEADED CUSHIONS*

COUTARD



450 mm / 17.71"

PM / SS



650 mm / 25.59"

GM / LS

FINITION / FINISHING

REFERENCE

EAN CODE



PM / SS

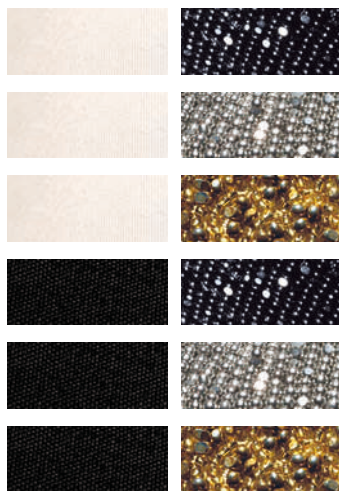

SOIE IVOIRE - *IVORY SILK*
PERLÉ NOIR - *BLACK GLASS BEADS*

10194800



SOIE IVOIRE - *IVORY SILK*
PERLÉ ARGENT - *SILVER GLASS BEADS*

10194801



SOIE IVOIRE - *IVORY SILK*
PERLÉ OR - *GOLD GLASS BEADS*

10194802



SOIE NOIRE - *BLACK SILK*
PERLÉ NOIR - *BLACK GLASS BEADS*

10194900



SOIE NOIRE - *BLACK SILK*
PERLÉ ARGENT - *SILVER GLASS BEADS*

10194901



SOIE NOIRE - *BLACK SILK*
PERLÉ OR - *GOLD GLASS BEADS*

10194902



GM / LS

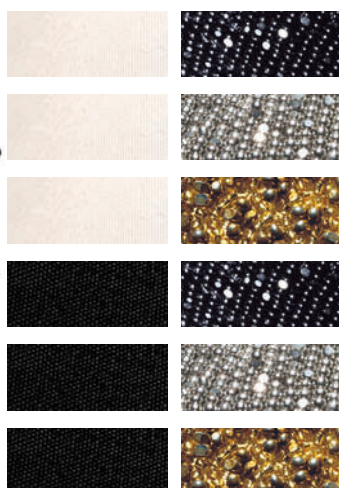

SOIE IVOIRE - *IVORY SILK*
PERLÉ NOIR - *BLACK GLASS BEADS*

10194400



SOIE IVOIRE - *IVORY SILK*
PERLÉ ARGENT - *SILVER GLASS BEADS*

10194401



SOIE IVOIRE - *IVORY SILK*
PERLÉ OR - *GOLD GLASS BEADS*

10194402



SOIE NOIRE - *BLACK SILK*
PERLÉ NOIR - *BLACK GLASS BEADS*

10194500



SOIE NOIRE - *BLACK SILK*
PERLÉ ARGENT - *SILVER GLASS BEADS*

10194501



SOIE NOIRE - *BLACK SILK*
PERLÉ OR - *GOLD GLASS BEADS*













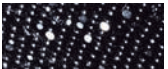

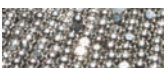







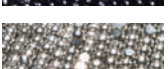





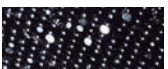



10194502

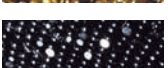

COUSSINS PERLÉS - *BEADED CUSHIONS*

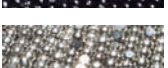
DEMI COUTARD



FINITION / FINISHING		REFERENCE	EAN CODE
 PM / SS	 	SOIE IVOIRE - <i>IVORY SILK</i> PERLÉ NOIR - <i>BLACK GLASS BEADS</i>	10201200 
	 	SOIE IVOIRE - <i>IVORY SILK</i> PERLÉ ARGENT - <i>SILVER GLASS BEADS</i>	10201201 
	 	SOIE IVOIRE - <i>IVORY SILK</i> PERLÉ OR - <i>GOLD GLASS BEADS</i>	10201202 
	 	SOIE NOIRE - <i>BLACK SILK</i> PERLÉ NOIR - <i>BLACK GLASS BEADS</i>	10201000 
	 	SOIE NOIRE - <i>BLACK SILK</i> PERLÉ ARGENT - <i>SILVER GLASS BEADS</i>	10201001 
	 	SOIE NOIRE - <i>BLACK SILK</i> PERLÉ OR - <i>GOLD GLASS BEADS</i>	10201002 
 GM / LS	 	SOIE IVOIRE - <i>IVORY SILK</i> PERLÉ NOIR - <i>BLACK GLASS BEADS</i>	10201100 
	 	SOIE IVOIRE - <i>IVORY SILK</i> PERLÉ ARGENT - <i>SILVER GLASS BEADS</i>	10201101 
	 	SOIE IVOIRE - <i>IVORY SILK</i> PERLÉ OR - <i>GOLD GLASS BEADS</i>	10201102 
	 	SOIE NOIRE - <i>BLACK SILK</i> PERLÉ NOIR - <i>BLACK GLASS BEADS</i>	10200900 
	 	SOIE NOIRE - <i>BLACK SILK</i> PERLÉ ARGENT - <i>SILVER GLASS BEADS</i>	10200901 
	 	SOIE NOIRE - <i>BLACK SILK</i> PERLÉ OR - <i>GOLD GLASS BEADS</i>	10200902 

2011 - LADY TINA GREEN & PIETRO MINGARELLI POUR LALIQUE

COUSSINS PERLÉS - *BEADED CUSHIONS*

DRAGON



FINITION / FINISHING

REFERENCE

EAN CODE

		SOIE IVOIRE - <i>IVORY SILK</i> PERLÉ NOIR - <i>BLACK GLASS BEADS</i>	11603410	 7 640111 505167
		SOIE IVOIRE - <i>IVORY SILK</i> PERLÉ ARGENT - <i>SILVER GLASS BEADS</i>	11603420	 7 640111 505174
		SOIE IVOIRE - <i>IVORY SILK</i> PERLÉ OR - <i>GOLD GLASS BEADS</i>	11603430	 7 640111 505181
		SOIE NOIRE - <i>BLACK SILK</i> PERLÉ ROUGE - <i>RED GLASS BEADS</i>	11603440	 7 640111 505198
		SOIE NOIRE - <i>BLACK SILK</i> PERLÉ ARGENT - <i>SILVER GLASS BEADS</i>	11603450	 7 640111 505204
		SOIE NOIRE - <i>BLACK SILK</i> PERLÉ OR - <i>GOLD GLASS BEADS</i>	11603460	 7 640111 505211

2011 - LADY TINA GREEN & PIETRO MINGARELLI POUR LALIQUE

COUSSINS PERLÉS - *BEADED CUSHIONS*











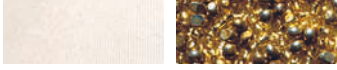
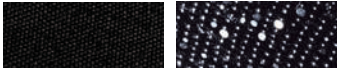
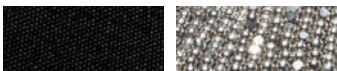

HIRONDELLES

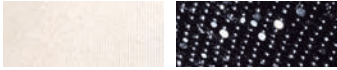

FINITION / FINISHING

REFERENCE

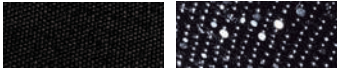
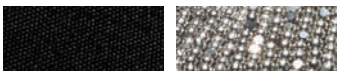
EAN CODE

 MM / MS		SOIE IVOIRE - <i>IVORY SILK</i> PERLÉ NOIR - <i>BLACK GLASS BEADS</i>	10193600	 7 640111 496489
		SOIE IVOIRE - <i>IVORY SILK</i> PERLÉ ARGENT - <i>SILVER GLASS BEADS</i>	10193601	 7 640111 499299
		SOIE IVOIRE - <i>IVORY SILK</i> PERLÉ OR - <i>GOLD GLASS BEADS</i>	10193602	 7 640111 505389
		SOIE NOIRE - <i>BLACK SILK</i> PERLÉ NOIR - <i>BLACK GLASS BEADS</i>	10193700	 7 640111 496496
		SOIE NOIRE - <i>BLACK SILK</i> PERLÉ ARGENT - <i>SILVER GLASS BEADS</i>	10193701	 7 640111 505396
		SOIE NOIRE - <i>BLACK SILK</i> PERLÉ OR - <i>GOLD GLASS BEADS</i>	10193702	 7 640111 499329
 GM / LS		SOIE IVOIRE - <i>IVORY SILK</i> PERLÉ NOIR - <i>BLACK GLASS BEADS</i>	10193200	 7 640111 496465
		SOIE IVOIRE - <i>IVORY SILK</i> PERLÉ ARGENT - <i>SILVER GLASS BEADS</i>	10193201	 7 640111 499251
		SOIE IVOIRE - <i>IVORY SILK</i> PERLÉ OR - <i>GOLD GLASS BEADS</i>	10193203	 7 640111 499268
		SOIE NOIRE - <i>BLACK SILK</i> PERLÉ NOIR - <i>BLACK GLASS BEADS</i>	10193300	 7 640111 496472
		SOIE NOIRE - <i>BLACK SILK</i> PERLÉ ARGENT - <i>SILVER GLASS BEADS</i>	10193301	 7 640111 499275
		SOIE NOIRE - <i>BLACK SILK</i> PERLÉ OR - <i>GOLD GLASS BEADS</i>	10193302	 7 640111 505372

2011 - LADY TINA GREEN & PIETRO MINGARELLI POUR LALIQUE

COUSSINS PERLÉS - *BEADED CUSHIONS*

MASQUE DE FEMME 1 BANDE LARGE / 1 LARGE BAND



FINITION / FINISHING	REFERENCE	EAN CODE
PM, 1 BANDE LARGE 300 x 450 mm <i>SS, 1 LARGE BAND</i> <i>11.81" x 17.71"</i>	SOIE IVOIRE - <i>IVORY SILK</i> PERLÉ NOIR - <i>BLACK GLASS BEADS</i>	10196000 7 640111 496762
	SOIE NOIRE - <i>BLACK SILK</i> PERLÉ NOIR - <i>BLACK GLASS BEADS</i>	10196100 7 640111 496779
MM, 1 BANDE LARGE 500 x 500 mm <i>MS, 1 LARGE BAND</i> <i>19.68" x 19.68"</i>	SOIE IVOIRE - <i>IVORY SILK</i> PERLÉ NOIR - <i>BLACK GLASS BEADS</i>	10200500 7 640111 497721
	SOIE NOIRE - <i>BLACK SILK</i> PERLÉ NOIR - <i>BLACK GLASS BEADS</i>	10200600 7 640111 497738
GM, 1 BANDE LARGE 600 x 600 mm <i>LS, 1 LARGE BAND</i> <i>23.62" x 23.62"</i>	SOIE IVOIRE - <i>IVORY SILK</i> PERLÉ NOIR - <i>BLACK GLASS BEADS</i>	10200300 7 640111 496786
	SOIE NOIRE - <i>BLACK SILK</i> PERLÉ NOIR - <i>BLACK GLASS BEADS</i>	10200400 7 640111 496793

2011 - LADY TINA GREEN & PIETRO MINGARELLI POUR LALIQUE

COUSSINS PERLÉS - *BEADED CUSHIONS*

MASQUE DE FEMME



FINITION / FINISHING	REFERENCE	EAN CODE
PM, 1 BANDE 300 x 450 mm <i>SS, 1 BAND</i> <i>11.81" x 17.71"</i>	  SOIE IVOIRE - <i>IVORY SILK</i> PERLÉ NOIR - <i>BLACK GLASS BEADS</i>	10200700  7 640111 497745
	  SOIE NOIRE - <i>BLACK SILK</i> PERLÉ NOIR - <i>BLACK GLASS BEADS</i>	10200800  7 640111 497929
MM, 3 BANDES 500 x 500 mm <i>MS, 3 BANDS</i> <i>19.68" x 19.68"</i>	  SOIE IVOIRE - <i>IVORY SILK</i> PERLÉ NOIR - <i>BLACK GLASS BEADS</i>	10195600  7 640111 496748
	  SOIE NOIRE - <i>BLACK SILK</i> PERLÉ NOIR - <i>BLACK GLASS BEADS</i>	10195700  7 640111 497752
GM, 5 BANDES 600 x 600 mm <i>LS, 5 BANDS</i> <i>23.62" x 23.62"</i>	  SOIE IVOIRE - <i>IVORY SILK</i> PERLÉ NOIR - <i>BLACK GLASS BEADS</i>	10195200  7 640111 496724
	  SOIE NOIRE - <i>BLACK SILK</i> PERLÉ NOIR - <i>BLACK GLASS BEADS</i>	10195300  7 640111 496731

2011 - LADY TINA GREEN & PIETRO MINGARELLI POUR LALIQUE

COUSSINS - CUSHIONS

PANTHÈRE / PANTHER



BRODÉ, MM / EMBROIDERY, MS

























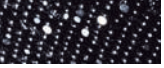

PERLÉ, PM / GLASS BEADS, SS

FINITION / FINISHING

REFERENCE

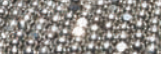
EAN CODE

 <p>BRODÉ, MM EMBROIDERY, MS</p> <p>450 x 300 mm 17.71" x 11.81"</p>			SOIE IVOIRE - <i>IVORY SILK</i> BRODÉ NOIR - <i>BLACK EMBROIDERY</i>	11602310	
			SOIE IVOIRE - <i>IVORY SILK</i> BRODÉ ARGENT - <i>SILVER EMBROIDERY</i>	11602320	
			SOIE IVOIRE - <i>IVORY SILK</i> BRODÉ OR - <i>GOLD EMBROIDERY</i>	11602330	
			SOIE PLATINE - <i>PLATINUM SILK</i> BRODÉ NOIR - <i>BLACK EMBROIDERY</i>	11602340	
			SOIE PLATINE - <i>PLATINUM SILK</i> BRODÉ ARGENT - <i>SILVER EMBROIDERY</i>	11602350	
			SOIE PLATINE - <i>PLATINUM SILK</i> BRODÉ OR - <i>GOLD EMBROIDERY</i>	11602360	
			SOIE NOIRE - <i>BLACK SILK</i> BRODÉ ARGENT - <i>SILVER EMBROIDERY</i>	11602370	
			SOIE NOIRE - <i>BLACK SILK</i> BRODÉ OR - <i>GOLD EMBROIDERY</i>	11602380	
 <p>PERLÉ, PM GLASS BEADS, SS</p> <p>560 x 400 mm 22.04" x 15.74"</p>			SOIE IVOIRE - <i>IVORY SILK</i> PERLÉ NOIR - <i>BLACK GLASS BEADS</i>	11603110	
			SOIE IVOIRE - <i>IVORY SILK</i> PERLÉ ARGENT - <i>SILVER GLASS BEADS</i>	11603120	
			SOIE IVOIRE - <i>IVORY SILK</i> PERLÉ OR - <i>GOLD GLASS BEADS</i>	11603130	
			SOIE PLATINE - <i>PLATINUM SILK</i> PERLÉ NOIR - <i>BLACK GLASS BEADS</i>	11603140	
			SOIE PLATINE - <i>PLATINUM SILK</i> PERLÉ ARGENT - <i>SILVER GLASS BEADS</i>	11603150	
			SOIE PLATINE - <i>PLATINUM SILK</i> PERLÉ OR - <i>GOLD GLASS BEADS</i>	11603160	
			SOIE NOIRE - <i>BLACK SILK</i> PERLÉ ARGENT - <i>SILVER GLASS BEADS</i>	11603170	
			SOIE NOIRE - <i>BLACK SILK</i> PERLÉ OR - <i>GOLD GLASS BEADS</i>	11603180	

2011 - LADY TINA GREEN & PIETRO MINGARELLI POUR LALIQUE

COUVRE-LITS PERLÉS - *BEADED BED-COVERS*

RAISINS



Détail du couvre-lit perlé / *Detail view of the beaded bed-cover*



Couvre-lit perlé / *Beaded bed-cover*

FINITION - *FINISHING*

			REFERENCE	EAN CODE		
COUVRE-LIT 314 x 270 cm POUR UN MATELAT 180 x 200 cm BED COVER 123.62" x 106.29" FOR A MATTRESS SIZE 180 x 200 cm			SOIE IVOIRE - <i>IVORY SILK</i> PERLÉ NOIR - <i>BLACK GLASS BEADS</i>	10201303		
			SOIE IVOIRE - <i>IVORY SILK</i> PERLÉ ARGENT - <i>SILVER GLASS BEADS</i>	10201304		
			SOIE IVOIRE - <i>IVORY SILK</i> PERLÉ OR - <i>GOLD GLASS BEADS</i>	10201305		
			SOIE NOIRE - <i>BLACK SILK</i> PERLÉ NOIR - <i>BLACK GLASS BEADS</i>	11201303		
			SOIE NOIRE - <i>BLACK SILK</i> PERLÉ ARGENT - <i>SILVER GLASS BEADS</i>	11201304		
			SOIE NOIRE - <i>BLACK SILK</i> PERLÉ OR - <i>GOLD GLASS BEADS</i>	11201305		
			SOIE IVOIRE - <i>IVORY SILK</i> RÉDUCTION, PERLÉ NOIRES - <i>REDUCED, BLACK GLASS BEADS</i>	10201313		
			SOIE IVOIRE - <i>IVORY SILK</i> RÉDUCTION, PERLÉ ARGENT - <i>REDUCED, SILVER GLASS BEADS</i>	10201314		
			SOIE IVOIRE - <i>IVORY SILK</i> RÉDUCTION, PERLÉ OR - <i>REDUCED, GOLD GLASS BEADS</i>	10201315		
	COUVRE-LIT 334 x 270 cm POUR UN MATELAT 200 x 200 cm BED COVER 131.49" x 106.29" FOR A MATTRESS SIZE 200 x 200 cm			SOIE IVOIRE - <i>IVORY SILK</i> PERLÉ NOIR - <i>BLACK GLASS BEADS</i>	10201300	
				SOIE IVOIRE - <i>IVORY SILK</i> PERLÉ ARGENT - <i>SILVER GLASS BEADS</i>	10201301	
				SOIE IVOIRE - <i>IVORY SILK</i> PERLÉ OR - <i>GOLD GLASS BEADS</i>	10201302	
				SOIE NOIRE - <i>BLACK SILK</i> PERLÉ NOIR - <i>BLACK GLASS BEADS</i>	11201300	
				SOIE NOIRE - <i>BLACK SILK</i> PERLÉ ARGENT - <i>SILVER GLASS BEADS</i>	11201301	
				SOIE NOIRE - <i>BLACK SILK</i> PERLÉ OR - <i>GOLD GLASS BEADS</i>	11201302	

2011 - LADY TINA GREEN & PIETRO MINGARELLI POUR LALIQUE

DRAPS BRODÉS - EMBROIDERED TOP FLAT SHEETS

RAISINS



FINITION / FINISHING	REFERENCE	EAN CODE
DRAP BRODÉ 260 x 285 cm POUR UN MATELAT 180 x 200 cm EMBROIDERED TOP FLAT SHEET 102.36" x 112.20" FOR A MATTRESS SIZE 180 x 200 cm	 COTON IVOIRE - IVORY COTTON BRODÉ NOIR - BLACK EMBROIDERY	11400831  7 640111 497943
	 COTON IVOIRE - IVORY COTTON BRODÉ IVOIRE - IVORY EMBROIDERY	11500800  7 640111 500285
	 COTON IVOIRE - IVORY COTTON BRODÉ ARGENT - SILVER EMBROIDERY	11500806  7 640111 499978
	 COTON IVOIRE - IVORY COTTON BRODÉ OR - GOLD EMBROIDERY	11500812  7 640111 500032
DRAP BRODÉ 280 x 300 cm POUR UN MATELAT 200 x 200 cm EMBROIDERED TOP FLAT SHEET 110.23" x 118.11" FOR A MATTRESS SIZE 200 x 200 cm	 COTON IVOIRE - IVORY COTTON BRODÉ NOIR - BLACK EMBROIDERY	11400832  7 640111 500292
	 COTON IVOIRE - IVORY COTTON BRODÉ IVOIRE - IVORY EMBROIDERY	11500801  7 640111 500278
	 COTON IVOIRE - IVORY COTTON BRODÉ ARGENT - SILVER EMBROIDERY	11500807  7 640111 499985
	 COTON IVOIRE - IVORY COTTON BRODÉ OR - GOLD EMBROIDERY	11500813  7 640111 500049

2011 - LADY TINA GREEN & PIETRO MINGARELLI POUR LALIQUE

DRAPS HOUSSE - PLAIN FLAT BOTTOM SHEETS

FINITION / FINISHING	REFERENCE	EAN CODE
270 x 300 cm POUR UN MATELAT 160-180 x 200 cm 106.30" x 118.11" FOR A MATTRESS SIZE 160-180 x 200 cm	 COTON IVOIRE IVORY COTTON	11400852  7 640111 505488
300 x 300 cm POUR UN MATELAT 180-200 x 200 cm 118.11" x 118.11" FOR A MATTRESS SIZE 180-200 x 200 cm	 COTON IVOIRE IVORY COTTON	11400851  7 640111 496946

2011 - LADY TINA GREEN & PIETRO MINGARELLI POUR LALIQUE

HOUSES DE COUETTE BRODÉES - EMBROIDERED DUVET COVERS

RAISINS



FINITION / FINISHING

**HOUSSE DE COUETTE
BRODÉE**
260 x 220 cm
POUR UN MATELAT
180 x 200 cm
**EMBROIDERED
DUVET COVER**
102.36" x 86.61"
FOR A MATTRESS SIZE
180 x 200 cm



COTON IVOIRE - *IVORY COTTON*
BRODÉ NOIR - *BLACK EMBROIDERY*

REFERENCE

11400810

EAN CODE



COTON IVOIRE - *IVORY COTTON*
BRODÉ IVOIRE - *IVORY EMBROIDERY*

11500804



COTON IVOIRE - *IVORY COTTON*
BRODÉ ARGENT - *SILVER EMBROIDERY*

11500810



COTON IVOIRE - *IVORY COTTON*
BRODÉ OR - *GOLD EMBROIDERY*

11500816



**HOUSSE DE COUETTE
BRODÉE**
280 x 235 cm
POUR UN MATELAT
200 x 200 cm
**EMBROIDERED
DUVET COVER**
110.23" x 92.51"
FOR A MATTRESS SIZE
200 x 200 cm

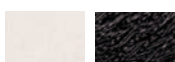

COTON IVOIRE - *IVORY COTTON*
BRODÉ NOIR - *BLACK EMBROIDERY*

11400811



COTON IVOIRE - *IVORY COTTON*
BRODÉ IVOIRE - *IVORY EMBROIDERY*

11500805



COTON IVOIRE - *IVORY COTTON*
BRODÉ ARGENT - *SILVER EMBROIDERY*

11500811



COTON IVOIRE - *IVORY COTTON*
BRODÉ OR - *GOLD EMBROIDERY*

11500817



2011 - LADY TINA GREEN & PIETRO MINGARELLI POUR LALIQUE

PLAID EN CACHEMIRE PERLÉ - *BEADED CASHMERE THROW*

HIRONDELLES



Photo non contractuelle / *Non contractual picture*
Les franges sont de couleur uniforme / *The fringes are of uniform color*

FINITION / *FINISHING*

PLAID
140 x 190 cm
THROW
55.11" x 74.80"

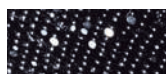

CACHEMIRE IVOIRE - *IVORY CASHMERE*
PERLÉ NOIR - *BLACK GLASS BEADS*

REFERENCE

81574710

EAN CODE



7 640163 972733

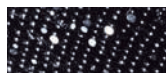

CACHEMIRE NOIR - *BLACK CASHMERE*
PERLÉ NOIR - *BLACK GLASS BEADS*

81584710



7 640163 972740

2011 - LADY TINA GREEN & PIETRO MINGARELLI POUR LALIQUE

TAIES D'OREILLER BRODÉES - *EMBROIDERED PILLOW CASES*

OXFORD



FINITION / *FINISHING*

REFERENCE

EAN CODE

50 x 90 cm <i>19.68" x 35.43"</i>			COTON IVOIRE - <i>IVORY COTTON</i> BRODÉ NOIR - <i>BLACK EMBROIDERY</i>	11400841	 7 640111 496984
			COTON IVOIRE - <i>IVORY COTTON</i> BRODÉ IVOIRE - <i>IVORY EMBROIDERY</i>	11500803	 7 640111 499947
			COTON IVOIRE - <i>IVORY COTTON</i> BRODÉ ARGENT - <i>SILVER EMBROIDERY</i>	11500809	 7 640111 500001
			COTON IVOIRE - <i>IVORY COTTON</i> BRODÉ OR - <i>GOLD EMBROIDERY</i>	11500815	 7 640111 500063

2011 - LADY TINA GREEN & PIETRO MINGARELLI POUR LALIQUE

Les taies sont vendues par deux. / *The pillow cases are sold per two.*

TAIES D'OREILLER BRODÉES - EMBROIDERED PILLOW CASES

RAISINS



FINITION / FINISHING

REFERENCE

EAN CODE

50 x 90 cm <i>19.68" x 35.43"</i>			COTON IVOIRE - <i>IVORY COTTON</i> BRODÉ NOIR - <i>BLACK EMBROIDERY</i>	11400821	
			COTON IVOIRE - <i>IVORY COTTON</i> BRODÉ IVOIRE - <i>IVORY EMBROIDERY</i>	11500802	
			COTON IVOIRE - <i>IVORY COTTON</i> BRODÉ ARGENT - <i>SILVER EMBROIDERY</i>	11500808	
			COTON IVOIRE - <i>IVORY COTTON</i> BRODÉ OR - <i>GOLD EMBROIDERY</i>	11500814	

2011 - LADY TINA GREEN & PIETRO MINGARELLI POUR LALIQUE

Les taies sont vendues par deux. / *The pillow cases are sold per two.*

CARRÉS BRODÉS - EMBROIDERED SQUARE TOWELS (FACE CLOTH)

LALIQUE



Coton ivoire - brodé noir
Ivory cotton - black embroidery



Coton ivoire - brodé ivoire
Ivory cotton - ivory embroidery



Coton ivoire - brodé argent
Ivory cotton - silver embroidery



Coton ivoire - brodé or
Ivory cotton - gold embroidery

FINITION / FINISHING

REFERENCE

EAN CODE

CARRÉS BRODÉS
33 x 33 cm
100% coton, 1100g
EMBROIDERED
SQUARE TOWELS
12.99" x 12.99"
100% cotton, 1100g



COTON IVOIRE - IVORY COTTON
BRODÉ NOIR - BLACK EMBROIDERY

11400110



7 640111 497011



COTON IVOIRE - IVORY COTTON
BRODÉ IVOIRE - IVORY EMBROIDERY

11400120



7 640111 497028

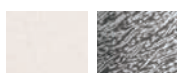

COTON IVOIRE - IVORY COTTON
BRODÉ ARGENT - SILVER EMBROIDERY

11400130



7 640111 497035



COTON IVOIRE - IVORY COTTON
BRODÉ OR - GOLD EMBROIDERY

11400140



7 640111 497042

2011 - LADY TINA GREEN & PIETRO MINGARELLI POUR LALIQUE



Coton ivoire - brodé noir
Ivory cotton - black embroidery

















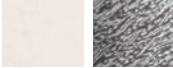







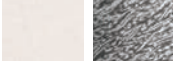







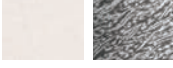

Coton ivoire - brodé ivoire
Ivory cotton - ivory embroidery



Coton ivoire - brodé argent
Ivory cotton - silver embroidery

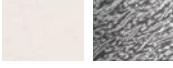













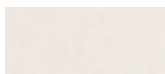



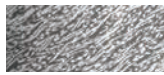











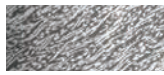







Coton ivoire - brodé or
Ivory cotton - gold embroidery

FINITION / FINISHING	REFERENCE	EAN CODE
SERVIETTES INVITÉ BRODÉES 40 x 60 cm 100% coton, 1100g <i>EMBROIDERED GUEST TOWELS 15.74" x 23.62"</i> 100% cotton, 1100g	 COTON IVOIRE - <i>IVORY COTTON</i> BRODÉ NOIR - <i>BLACK EMBROIDERY</i>	11400210  7 640111 497059
	 COTON IVOIRE - <i>IVORY COTTON</i> BRODÉ IVOIRE - <i>IVORY EMBROIDERY</i>	11400220  7 640111 497066
	 COTON IVOIRE - <i>IVORY COTTON</i> BRODÉ ARGENT - <i>SILVER EMBROIDERY</i>	11400230  7 640111 497073
	 COTON IVOIRE - <i>IVORY COTTON</i> BRODÉ OR - <i>GOLD EMBROIDERY</i>	11400240  7 640111 497080
SERVIETTES POUR LES MAINS BRODÉES 50 x 100 cm 100% coton, 1100g <i>EMBROIDERED HANDS TOWELS 19.68" x 39.37"</i> 100% cotton, 1100g	 COTON IVOIRE - <i>IVORY COTTON</i> BRODÉ NOIR - <i>BLACK EMBROIDERY</i>	11400310  7 640111 497097
	 COTON IVOIRE - <i>IVORY COTTON</i> BRODÉ IVOIRE - <i>IVORY EMBROIDERY</i>	11400320  7 640111 497950
	 COTON IVOIRE - <i>IVORY COTTON</i> BRODÉ ARGENT - <i>SILVER EMBROIDERY</i>	11400330  7 640111 497110
	 COTON IVOIRE - <i>IVORY COTTON</i> BRODÉ OR - <i>GOLD EMBROIDERY</i>	11400340  7 640111 497967
SERVIETTES DE BAIN BRODÉES 70 x 140 cm 100% coton, 1100g <i>EMBROIDERED BATH TOWELS 27.55" x 55.11"</i> 100% cotton, 1100g	 COTON IVOIRE - <i>IVORY COTTON</i> BRODÉ NOIR - <i>BLACK EMBROIDERY</i>	11400410  7 640111 497134
	 COTON IVOIRE - <i>IVORY COTTON</i> BRODÉ IVOIRE - <i>IVORY EMBROIDERY</i>	11400420  7 640111 497141
	 COTON IVOIRE - <i>IVORY COTTON</i> BRODÉ ARGENT - <i>SILVER EMBROIDERY</i>	11400430  7 640111 497158
	 COTON IVOIRE - <i>IVORY COTTON</i> BRODÉ OR - <i>GOLD EMBROIDERY</i>	11400440  7 640111 497974
DRAPS DE BAIN BRODÉS 90 x 160 cm 100% coton, 1100g <i>EMBROIDERED BATH SHEETS 35.43" x 62.99"</i> 100% cotton, 1100g	 COTON IVOIRE - <i>IVORY COTTON</i> BRODÉ NOIR - <i>BLACK EMBROIDERY</i>	11400510  7 640111 497172
	 COTON IVOIRE - <i>IVORY COTTON</i> BRODÉ IVOIRE - <i>IVORY EMBROIDERY</i>	11400520  7 640111 497189
	 COTON IVOIRE - <i>IVORY COTTON</i> BRODÉ ARGENT - <i>SILVER EMBROIDERY</i>	11400530  7 640111 497196
	 COTON IVOIRE - <i>IVORY COTTON</i> BRODÉ OR - <i>GOLD EMBROIDERY</i>	11400540  7 640111 497202

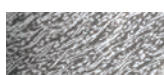
PEIGNOIRS BRODÉS - EMBROIDERED BATHROBES

HIRONDELLES

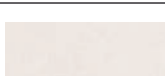
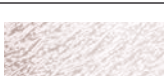

FINITION / FINISHING		REFERENCE	EAN CODE
TAILLE S 100% coton, 1100g SIZE S 100% cotton, 1100g			COTON IVOIRE - <i>IVORY COTTON</i> BRODÉ NOIR - <i>BLACK EMBROIDERY</i>
	11400710		7 640111 497257
			COTON IVOIRE - <i>IVORY COTTON</i> BRODÉ IVOIRE - <i>IVORY EMBROIDERY</i>
	11400720		7 640111 497981
TAILLE M 100% coton, 1100g SIZE M 100% cotton, 1100g			COTON IVOIRE - <i>IVORY COTTON</i> BRODÉ ARGENT - <i>SILVER EMBROIDERY</i>
	11400730		7 640111 497318
			COTON IVOIRE - <i>IVORY COTTON</i> BRODÉ OR - <i>GOLD EMBROIDERY</i>
	11400740		7 640111 497349
TAILLE L 100% coton, 1100g SIZE L 100% cotton, 1100g			COTON IVOIRE - <i>IVORY COTTON</i> BRODÉ NOIR - <i>BLACK EMBROIDERY</i>
	11400711		7 640111 497264
			COTON IVOIRE - <i>IVORY COTTON</i> BRODÉ IVOIRE - <i>IVORY EMBROIDERY</i>
	11400721		7 640111 497295
TAILLE XL 100% coton, 1100g SIZE XL 100% cotton, 1100g			COTON IVOIRE - <i>IVORY COTTON</i> BRODÉ ARGENT - <i>SILVER EMBROIDERY</i>
	11400731		7 640111 497325
			COTON IVOIRE - <i>IVORY COTTON</i> BRODÉ OR - <i>GOLD EMBROIDERY</i>
	11400741		7 640111 497356
TAILLE L 100% coton, 1100g SIZE L 100% cotton, 1100g			COTON IVOIRE - <i>IVORY COTTON</i> BRODÉ NOIR - <i>BLACK EMBROIDERY</i>
	11400712		7 640111 497271
			COTON IVOIRE - <i>IVORY COTTON</i> BRODÉ IVOIRE - <i>IVORY EMBROIDERY</i>
	11400722		7 640111 497301
TAILLE L 100% coton, 1100g SIZE L 100% cotton, 1100g			COTON IVOIRE - <i>IVORY COTTON</i> BRODÉ ARGENT - <i>SILVER EMBROIDERY</i>
	11400732		7 640111 497332
			COTON IVOIRE - <i>IVORY COTTON</i> BRODÉ OR - <i>GOLD EMBROIDERY</i>
	11400742		7 640111 497363
TAILLE XL 100% coton, 1100g SIZE XL 100% cotton, 1100g			COTON IVOIRE - <i>IVORY COTTON</i> BRODÉ IVOIRE - <i>IVORY EMBROIDERY</i>
	11400723		7 640111 506805

2011 - LADY TINA GREEN & PIETRO MINGARELLI POUR LALIQUE

TAPIS DE BAIN BRODÉS - EMBROIDERED BATH MATS

HIRONDELLES



Coton ivoire - brodé noir
Ivory cotton - black embroidery



Coton ivoire - brodé ivoire
Ivory cotton - ivory embroidery



Coton ivoire - brodé argent
Ivory cotton - silver embroidery



Coton ivoire - brodé or
Ivory cotton - gold embroidery

FINITION / FINISHING

TAPIS DE BAIN BRODÉS
60 X 100 cm
100% coton, 1100g
EMBROIDERED
BATH MATS
23.62" x 29.37"
100% cotton, 1100g



COTON IVOIRE - IVORY COTTON
BRODÉ NOIR - BLACK EMBROIDERY

REFERENCE

11400610

EAN CODE



COTON IVOIRE - IVORY COTTON
BRODÉ IVOIRE - IVORY EMBROIDERY

11400620

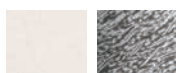

COTON IVOIRE - IVORY COTTON
BRODÉ ARGENT - SILVER EMBROIDERY

11400630



COTON IVOIRE - IVORY COTTON
BRODÉ OR - GOLD EMBROIDERY

11400640



2011 - LADY TINA GREEN & PIETRO MINGARELLI POUR LALIQUE

SERVIETTES ET SETS DE TABLE - *NAPKINS AND PLACEMATS*

1 HIRONDELLE

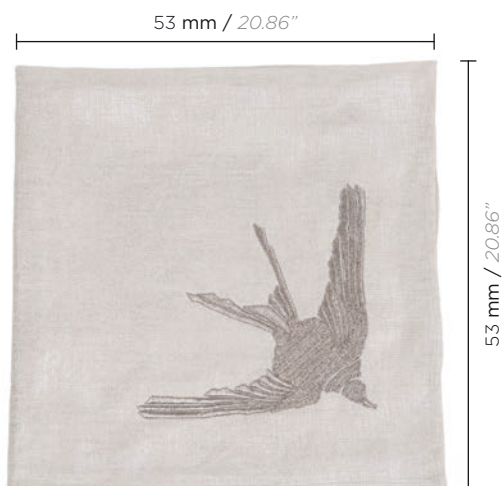

SERVIETTE DE TABLE CARRÉE
SQUARE NAPKINS



SET DE TABLE RECTANGULAIRE
RECTANGULAR PLACEMAT

FINITION / *FINISHING*

REFERENCE

EAN CODE

SERVIETTE DE TABLE CARRÉE / SQUARE NAPKINS

À L'UNITÉ
PER UNIT



LIN MÉTALISÉ - *METALLIC LINEN*
BRODÉ ÉTAIN - *PEWTER EMBROIDERY*

11601310



SET DE 4
SET OF 4



LIN MÉTALISÉ - *METALLIC LINEN*
BRODÉ ÉTAIN - *PEWTER EMBROIDERY*

11601340



SET DE TABLE RECTANGULAIRE / RECTANGULAR PLACEMAT

À L'UNITÉ
PER UNIT



LIN MÉTALISÉ - *METALLIC LINEN*
BRODÉ ÉTAIN - *PEWTER EMBROIDERY*

11600110



SET DE 4
SET OF 4



LIN MÉTALISÉ - *METALLIC LINEN*
BRODÉ ÉTAIN - *PEWTER EMBROIDERY*

11600140



2011 - LADY TINA GREEN & PIETRO MINGARELLI POUR LALIQUE

SERVIETTES ET SETS DE TABLE - *NAPKINS AND PLACEMATS*

4 HIRONDELLES

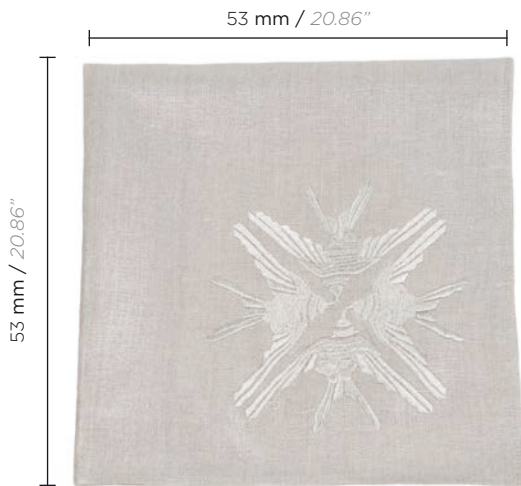

SERVIETTE DE TABLE CARRÉE
SQUARE NAPKINS



SET DE TABLE CIRCULAIRE
CIRCULAR PLACEMAT

FINITION / *FINISHING*

REFERENCE

EAN CODE

SERVIETTE DE TABLE CARRÉE / SQUARE NAPKINS



À L'UNITÉ
PER UNIT

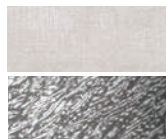

LIN MÉTALISÉ - *METALLIC LINEN*
BRODÉ ARGENT - *SILVER EMBROIDERY*

11601210



SET DE 4
SET OF 4

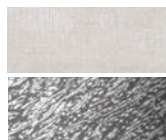

LIN MÉTALISÉ - *METALLIC LINEN*
BRODÉ ARGENT - *SILVER EMBROIDERY*

11601240



SET DE TABLE CIRCULAIRE / CIRCULAR PLACEMAT



À L'UNITÉ
PER UNIT

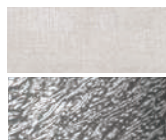

LIN MÉTALISÉ - *METALLIC LINEN*
BRODÉ ARGENT - *SILVER EMBROIDERY*

11600410



SET DE 4
SET OF 4

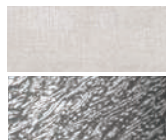

LIN MÉTALISÉ - *METALLIC LINEN*
BRODÉ ARGENT - *SILVER EMBROIDERY*

11600440



2011 - LADY TINA GREEN & PIETRO MINGARELLI POUR LALIQUE

SERVIETTES ET SETS DE TABLE - *NAPKINS AND PLACEMATS*

2 POISSONS / *KOI CIRCLE*

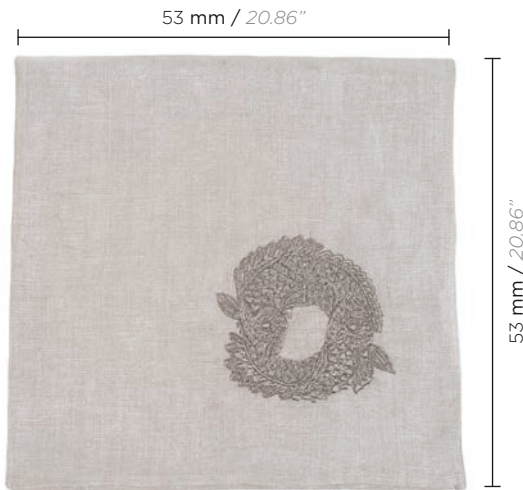

SERVIETTE DE TABLE CARRÉE
SQUARE NAPKINS

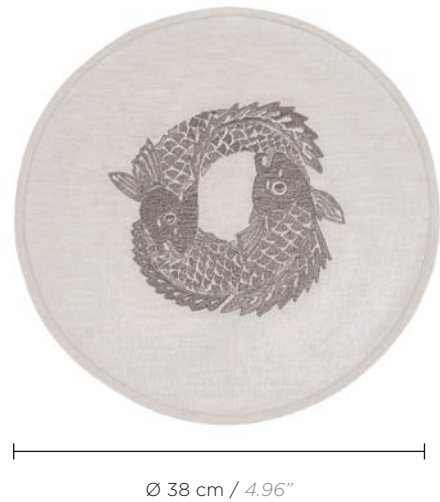

SET DE TABLE CIRCULAIRE
CIRCULAR PLACEMAT

FINITION / *FINISHING*

REFERENCE

EAN CODE

SERVIETTE DE TABLE CARRÉE / *SQUARE NAPKINS*



À L'UNITÉ
PER UNIT



LIN MÉTALISÉ - *METALLIC LINEN*
BRODÉ ÉTAIN - *PEWTER EMBROIDERY*

1160110



SET DE 4
SET OF 4



LIN MÉTALISÉ - *METALLIC LINEN*
BRODÉ ÉTAIN - *PEWTER EMBROIDERY*

11601140



SET DE TABLE CIRCULAIRE / *CIRCULAR PLACEMAT*



À L'UNITÉ
PER UNIT



LIN MÉTALISÉ - *METALLIC LINEN*
BRODÉ ÉTAIN - *PEWTER EMBROIDERY*

11600310



SET DE 4
SET OF 4



LIN MÉTALISÉ - *METALLIC LINEN*
BRODÉ ÉTAIN - *PEWTER EMBROIDERY*

11600340



2011 - LADY TINA GREEN & PIETRO MINGARELLI POUR LALIQUE

SERVIETTES ET SETS DE TABLE - *NAPKINS AND PLACEMATS*

RINCEAUX / *SCALLOP*

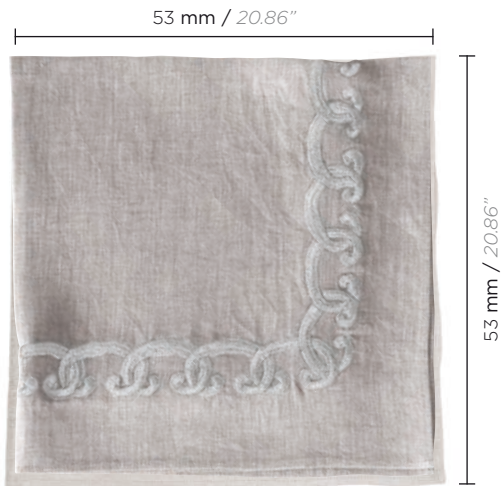

SERVIETTE DE TABLE CARRÉE
SQUARE NAPKINS

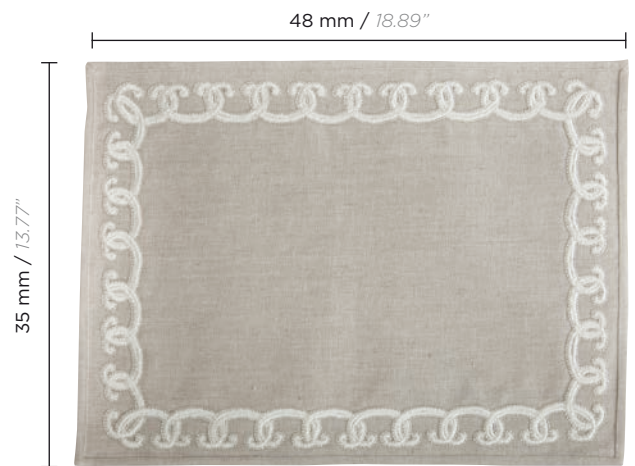

SET DE TABLE RECTANGULAIRE
RECTANGULAR PLACEMAT

FINITION / *FINISHING*

SERVIETTE DE TABLE CARRÉE / *SQUARE NAPKINS*



À L'UNITÉ
PER UNIT

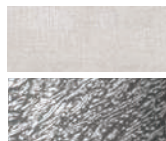

LIN MÉTALISÉ - *METALLIC LINEN*
BRODÉ ARGENT - *SILVER EMBROIDERY*

11601410



SET DE 4
SET OF 4

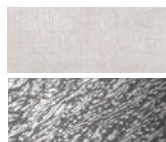

LIN MÉTALISÉ - *METALLIC LINEN*
BRODÉ ARGENT - *SILVER EMBROIDERY*

11601440



SET DE TABLE RECTANGULAIRE / *RECTANGULAR PLACEMAT*



À L'UNITÉ
PER UNIT

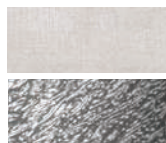

LIN MÉTALISÉ - *METALLIC LINEN*
BRODÉ ARGENT - *SILVER EMBROIDERY*

11600210



SET DE 4
SET OF 4

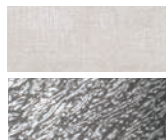

LIN MÉTALISÉ - *METALLIC LINEN*
BRODÉ ARGENT - *SILVER EMBROIDERY*

11600240



Photos non contractuelles.

Les produits ne sont pas représentés à leurs tailles réelles. Édition janvier 2019.

RCS Paris B775 667 736 - SA dont le siège social est situé
11, rue Royale - 75008 Paris - France
Capital social de 34.400.000 €

RCS Zurich CHE-203.099.958 dont le siège social est situé
Grubenstrasse 18 - CH-8045 Zürich - Switzerland
Capital social de CHF 100,000

Droits réservés

Non-contractual photos.

The products are not represented in their actual sizes. January 2019 edition.

*Trade and companies' register B775 667 736
11, rue Royale - 75008 Paris - France
Authorized capital 34.400.000 €*

*Trade and companies' register Zurich CHE-203.099.958
Grubenstrasse 18 - CH-8045 Zürich - Switzerland
Capital social de CHF 100,000*

All rights reserved

LALIQUE

11, rue Royale 75008 PARIS

Tél : (33) 01 53 05 12 12

lalique.com

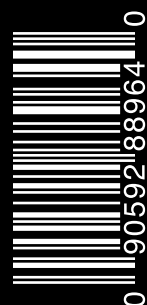

REF : 10673800