



# RIVIERE



- 1 VPL/P g - lacquered tray with hand woven leather handles, gold details, 46x31
- 2 VPD/L g - lacquered tray with leather wrapped / gold metal handles, 20x30
- 3 VGD/L g - lacquered tray with leather wrapped / gold metal handles, 26x39
- 4 BT-L g - vanity tray, lacquered wood base and braided leather trim, gold metal details, 16x32

# RIVIERE

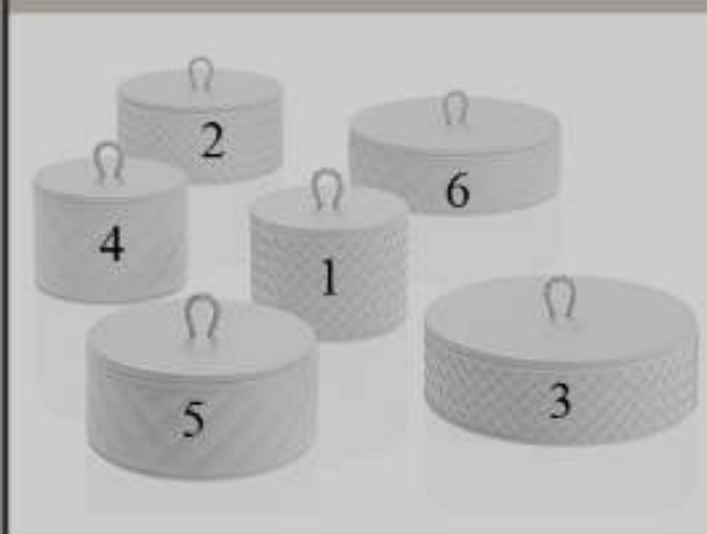

- 1 RBX1-INT - round leather box with lid, hand woven finish,  $\varnothing$  12 h9
- 2 RBX2-INT - round leather box with lid, hand woven finish,  $\varnothing$  16 h7,5
- 3 RBX3-INT - round leather box with lid, hand woven finish,  $\varnothing$  20 h6

- 4 RBX1-PT - round leather box with lid, quilted padded finish,  $\varnothing$  12 h9
- 5 RBX2-PT - round leather box with lid, quilted padded finish,  $\varnothing$  16 h7,5
- 6 RBX3-PT - round leather box with lid, quilted padded finish,  $\varnothing$  20 h6

RIVIERE

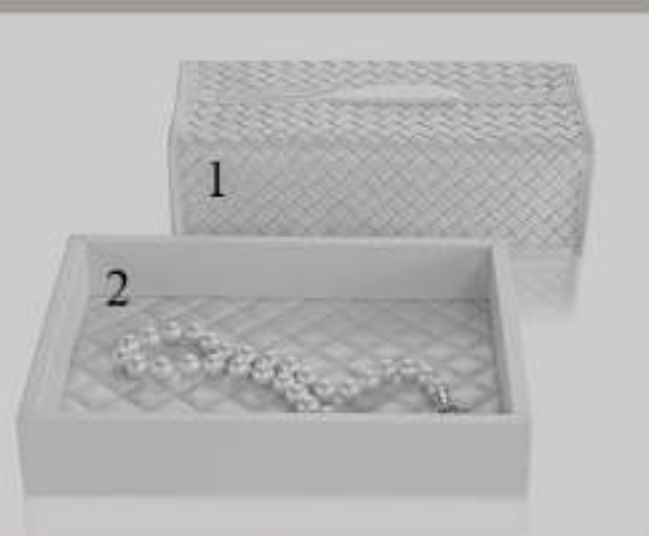

- 1 PC-INT RECT - rectangular hand woven leather tissue box holder  
2 VT3-PT - small leather tray / vide-poches with quilted lining, cm 18x24

# RIVIERE

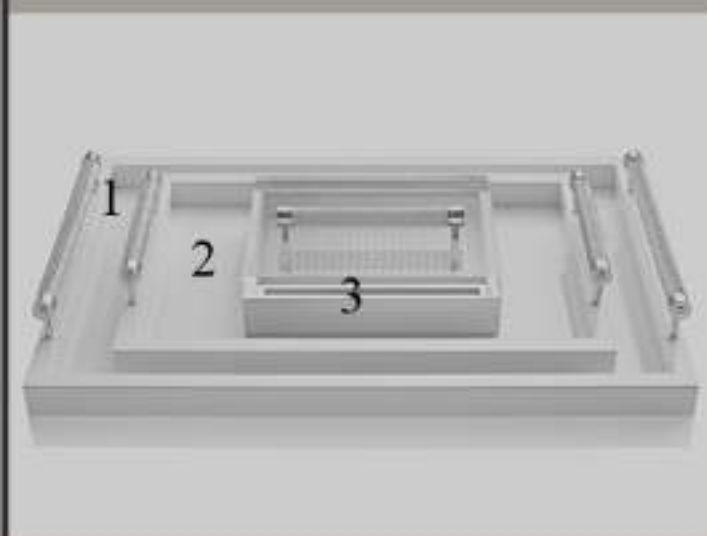
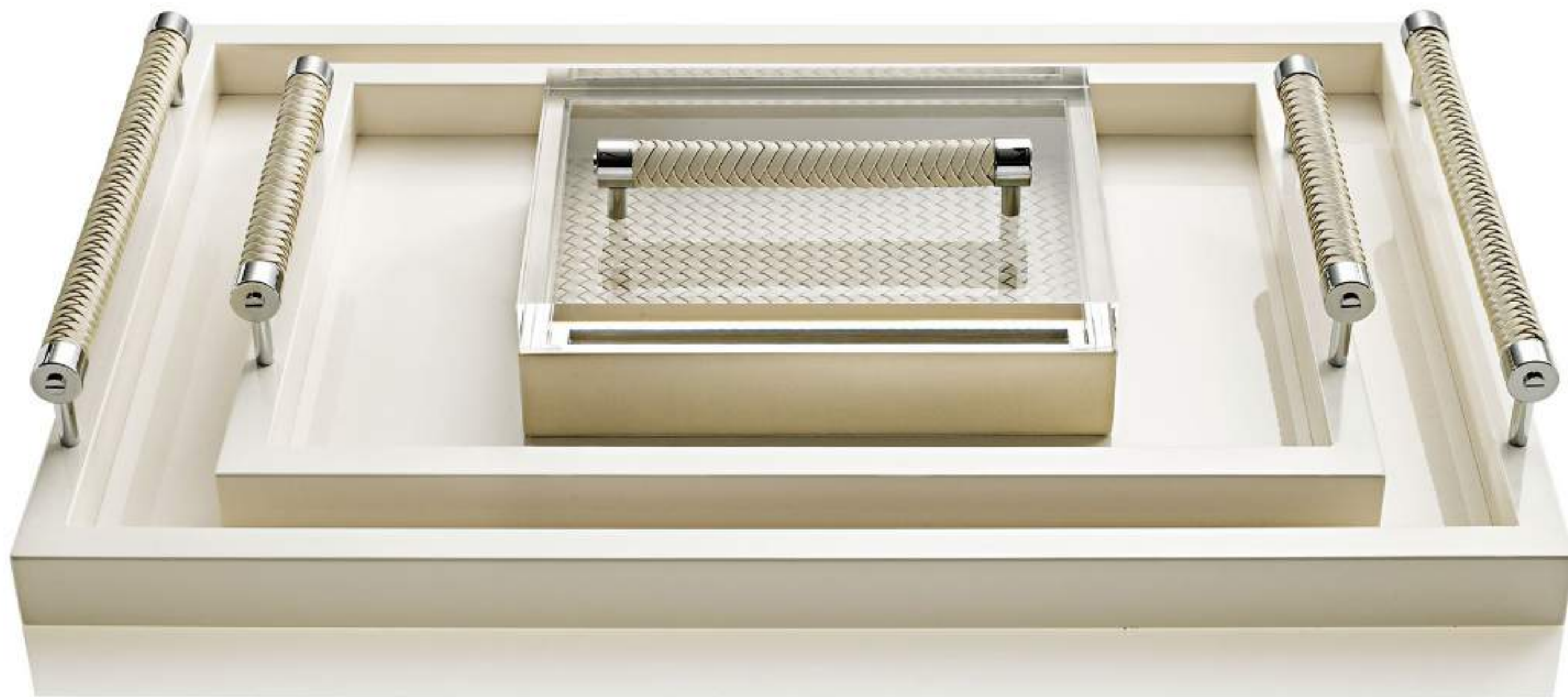

1 VGL/P - lacquered tray with hand woven leather handles, cm 60x40

2 VPL/P - lacquered tray with hand woven leather handles, cm 46x31

3 S3-INT/P - leather box with hand woven padded lining, acrylic lid and hand woven handle, cm 18x24xh6,5

# RIVIERE



- 1 VT5-IM - small leather tray / vide-poches, stitched padded leather lining, 18x18xh3
- 2 VPD/L g lacquered tray with leather wrapped/chrome metal handles, 20x30
- 3 S1-PT/FL - leather box, quilted padded lining and leather flower (camelia), 15x15xh6,5

# RIVIERE

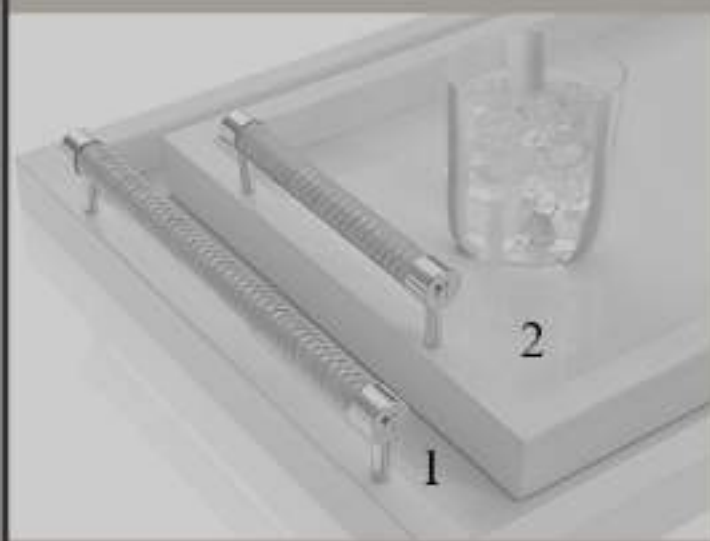

1 VGL/P g - lacquered tray with hand woven leather handles, gold details, 60x40

2 VPL/P g - lacquered tray with hand woven leather handles, gold details, 46x31

# RIVIERE

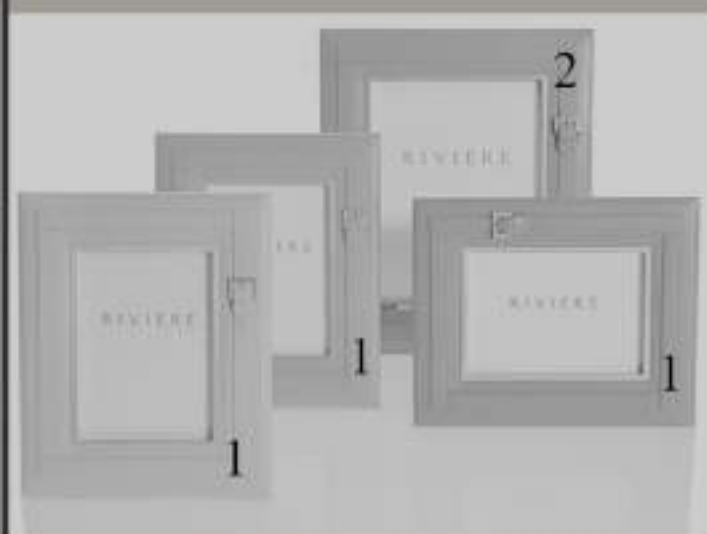

1 F2-BL - leather frame with "belt" decoration, chrome details, picture size 13x18

2 F3-BL - leather frame with "belt" decoration, chrome details, picture size 18x24



# RIVIERE

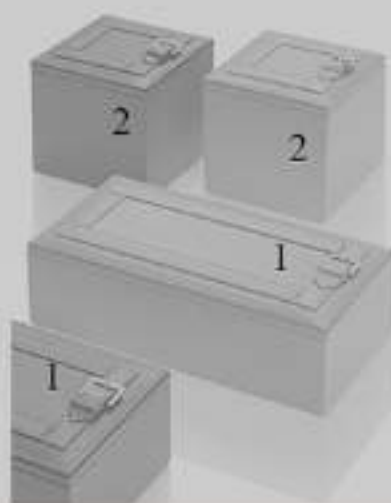

1 BX-BL rect - rectangular leather box with "belt" decoration, chrome details, 25x12x7 h.

2 BX-BL sq - square leather box with "belt" decoration, chrome details, 12x12x11 h.

RIVIERE



1 BX-BL/GL - leather sunglasses box with "belt" decoration, for 6 pairs, chrome details, suede lining, 33x22x9 h.

RIVIERE

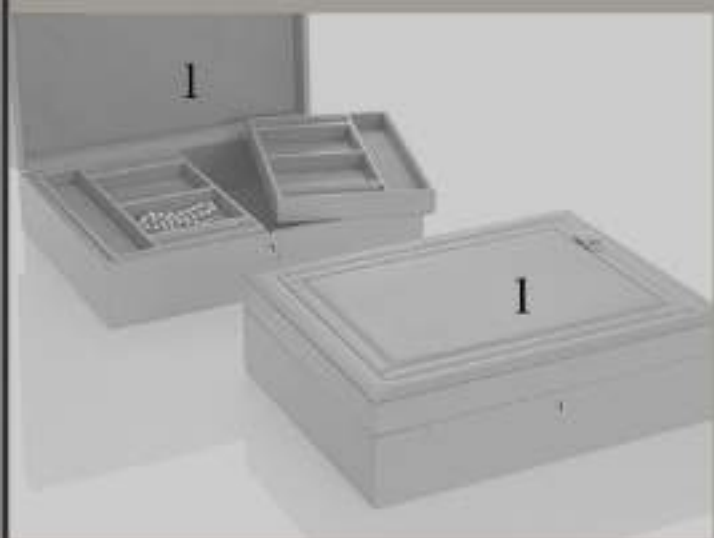

1 WBX-BL lg - leather jewellery box with "belt" decoration, double removable tray, chrome details, suede lining, 37x28x11 h.

# RIVIERE

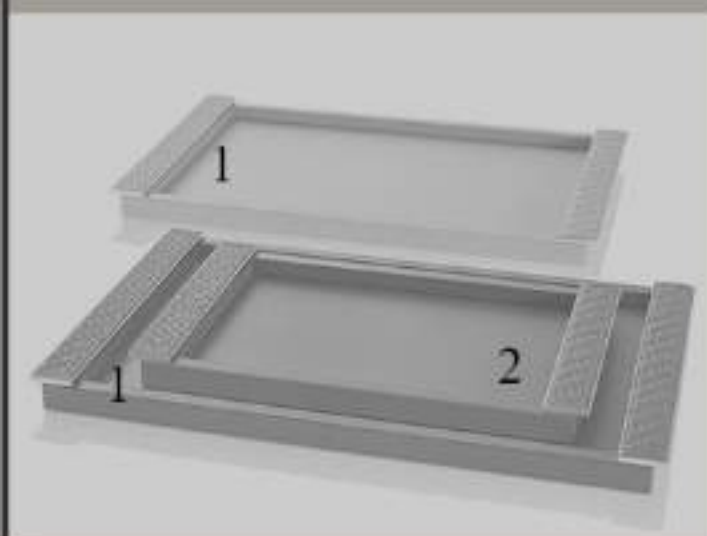

1 VG-ST - leather tray with braided leather plate handles, chrome details, 50x35

2 VP-ST - leather tray with braided leather plate handles, chrome details, 36x26

# RIVIERE

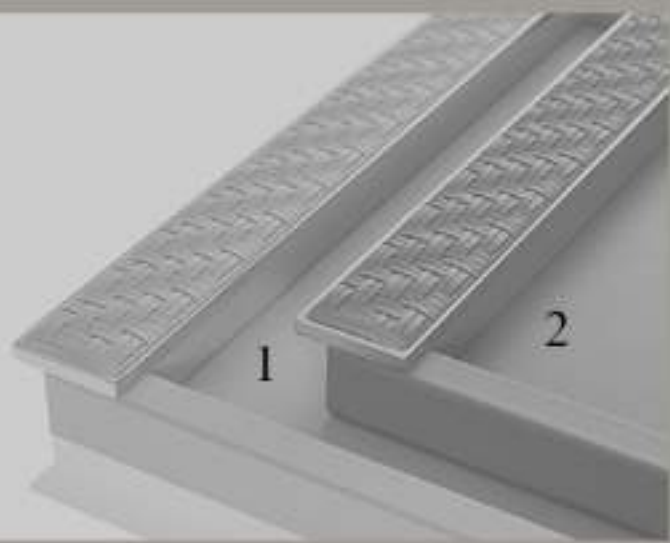

1 VG-ST - leather tray with braided leather plate handles, chrome details, 50x35

2 VP-ST - leather tray with braided leather plate handles, chrome details, 36x26

# RIVIERE



- 1 F2-SC/IN - leather frame with inner braided trim, chrome details, picture size 13x18
- 2 F2-SC/EX - leather frame with inner chrome trim and outer braided trim, picture size 13x18
- 3 F3-SC/IN - leather frame with inner braided trim, chrome details, picture size 18x24

# RIVIERE

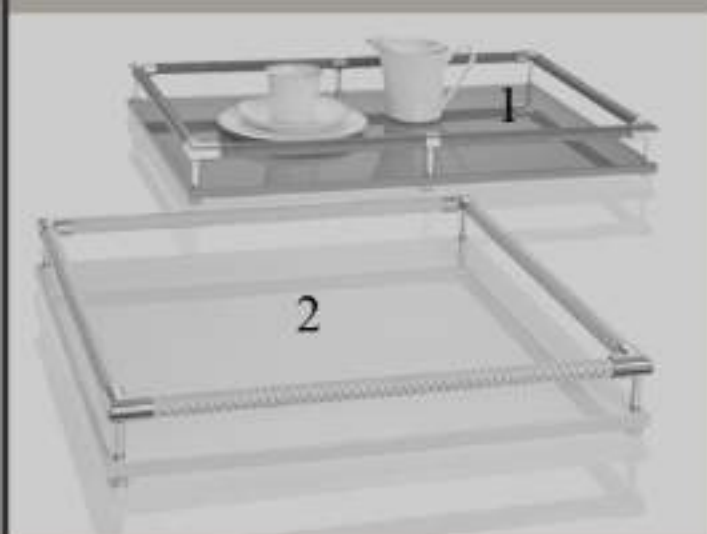

1 V-SC rect - rectangular lacquered tray with hand braided leather railing, chrome details, cm 35x50

2 V-SC sq - square lacquered tray with hand braided leather railing, chrome details, cm 40x40

# RIVIERE

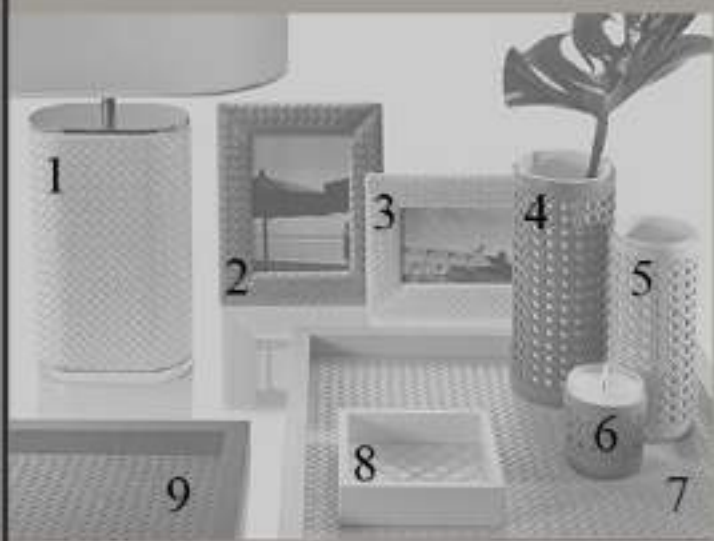

1 LOP - oval lamp encased in hand woven leather, chrome details, oval lampshade - tot h cm 60

2 F2-INT - woven leather frame, picture size cm 13x18

3 F1-INT - woven leather frame, picture size cm 10x15

4 V2-PDV - bone china vase with removable hand braided leather cover, h cm 26 ø cm 10

5 V1-PDV - bone china vase with removable hand braided leather cover, h cm 22 ø cm 8

6 B-PDV - scented candle with removable braided leather cover, h cm 9 ø cm 8

7 VGQ-INT - square leather tray, hand woven lining, cm 46x46

8 VT1-PT - small leather tray/ vide-poches with quilted lining, cm 15x15

9 VPQ-INT - square leather tray, hand woven lining, cm 37x37



RIVIERE



1 PR-INT - leather magazine holder, woven leather on two sides, lining in varnished wood, cm 35x20xh25

# RIVIERE



1 WB-INT LG - large leather wastebasket, woven leather on two sides, lining in varnished wood, cm 23x23xh30

2 WB-INT SM - small leather wastebasket, woven leather on two sides, lining in varnished wood, cm 20x20xh23

# RIVIERE



1 - DS-PC pen cup cm 8x8xh11

2 - DS-PP mail holder cm 21x10xh9

3 - F1-INT woven leather frame, picture size cm 10x15

4 - DS-BX rectangular box cm 25x10xh5,5

5 - DS-BL desk pad cm 60x40

6 - DS-PT paper tray cm 32,5X24Xh5,5

7 - DS-L/M letter opener and magnifier with braided leather handles

8 - F3-INT woven leather frame, picture size cm. 18x24

RIVIERE



1 BE-INT - hand woven leather bookends , cm 17x13xh17

RIVIERE



1 S8-INT/P - large leather box with hand woven lining, acrylic lid, woven leather handle, cm 42x31x10

RIVIERE



1 WBX-L - lacquered jewellery box with removable tray, suede lining, hand braided leather inlay, cm 29x20xh9

# RIVIERE

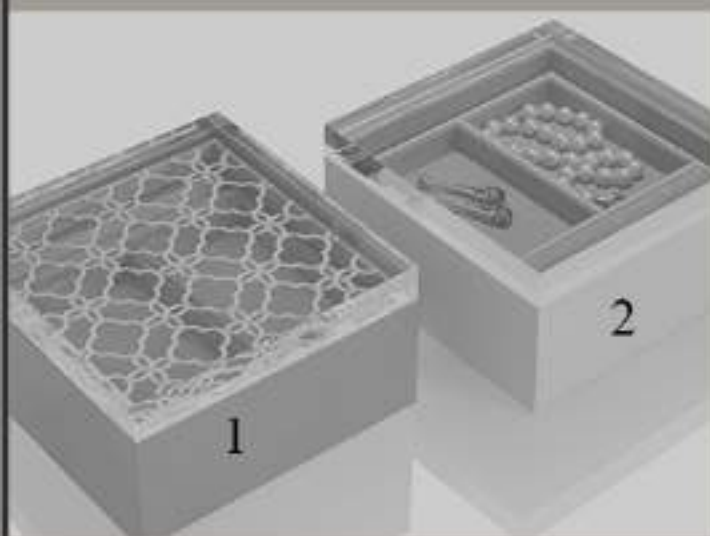

1 JB-CF leather jewellery box with removable tray, suede lining, floral carved acrylic lid, cm 20x20xh11

2 JB leather jewellery box with removable tray, suede lining, plain acrylic lid, cm 20x20xh11

# RIVIERE



1 VGQ-LP - square lacquered tray with leather frame, cm 46x46

2 VPQ-LP - square lacquered tray with leather frame, cm 37x37

3 VT3-PT - small leather tray /vide-poches with quilted lining, cm 18x24

4 WB-PT SM - small leather wastebasket, quilted leather on two sides, lining in varnished wood, cm 20x20xh23

5 PC-PT RECT - rectangular quilted leather tissue box holder

6 VT5-TF - small leather tray /vide-poches with quilted lining floral decor, cm 18x18



# RIVIERE

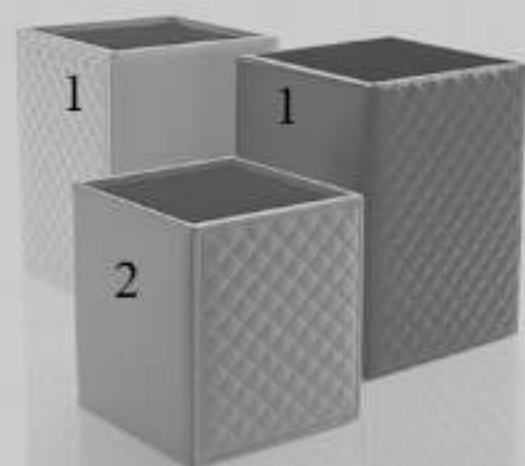

- 1 WB-PT lg - large leather wastebasket, quilted leather on two sides, lining in varnished wood, cm 23x23xh30
- 2 WB-PT sm - small leather wastebasket, quilted leather on two sides, lining in varnished wood, cm 20x20xh23

# RIVIERE



1 S1-PT/FL - leather box with quilted lining, acrylic lid with leather flower, cm 15x15xh6,5

2 VT3-TC - small leather tray / vide-poches with quilted striped lining, cm 18x24

RIVIERE

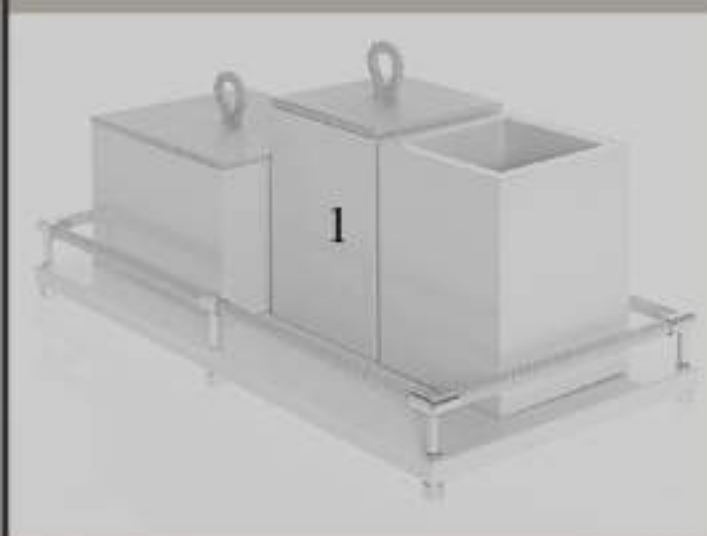

1 BS-L - bathroom set, lacquered wood and leather, cm 16x32xh12

# RIVIERE



- 1 VT8-PT - multi purpose container box, quilted leather, cm 30x15xh12,5
- 2 BT-L - vanity tray, lacquered wood base and braided leather trim , size cm 16x32
- 3 VM1 - leather vanity mirror, size of mirror cm 18x24

# RIVIERE



1 PC-PT SQ - square quilted leather tissue box holder

2 PC-INT RECT - rectangular hand woven leather tissue box holder

3 PC-PT RECT - rectangular quilted leather tissue box holder

4 PC-INT SQ - square woven leather tissue box holder

# RIVIERE



1 F2-PT - quilted leather frame, chrome trimming, picture size, cm 13x18

2 F2-PT - quilted leather frame, chrome trimming, picture size, cm 13x18

3 VPL/P - lacquered tray with hand woven leather handles, cm 46x31

# RIVIERE

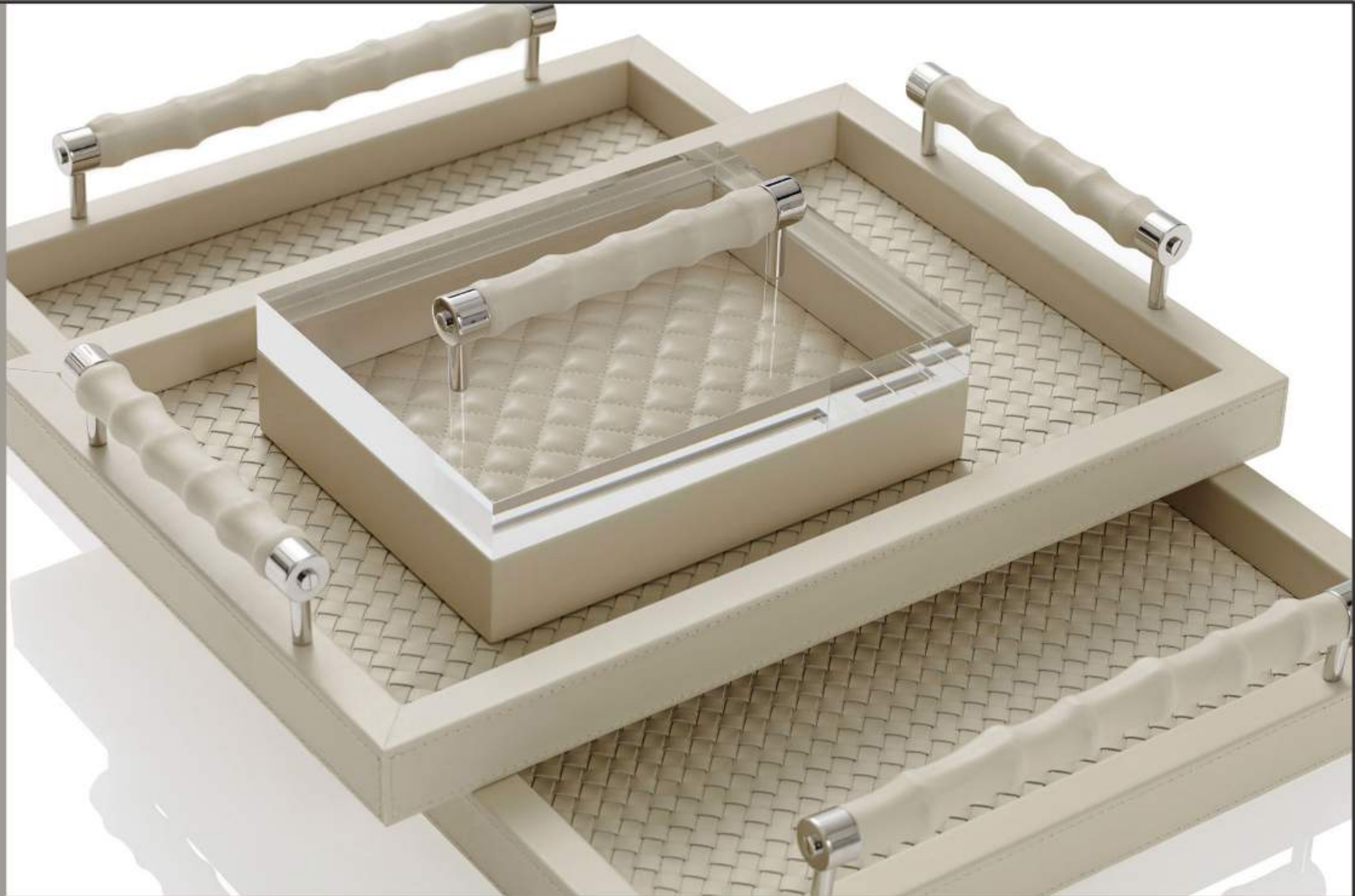

- 1 VG-INT/BP - leather tray with hand woven lining, leather covered bamboo handles, cm 60x40
- 2 VP-INT/BP - leather tray with hand woven lining, leather covered bamboo handles, cm 46x31
- 3 S3-PT/BP - leather box with quilted lining, acrylic lid, leather covered bamboo handle, cm 18x24xh6,5

# RIVIERE

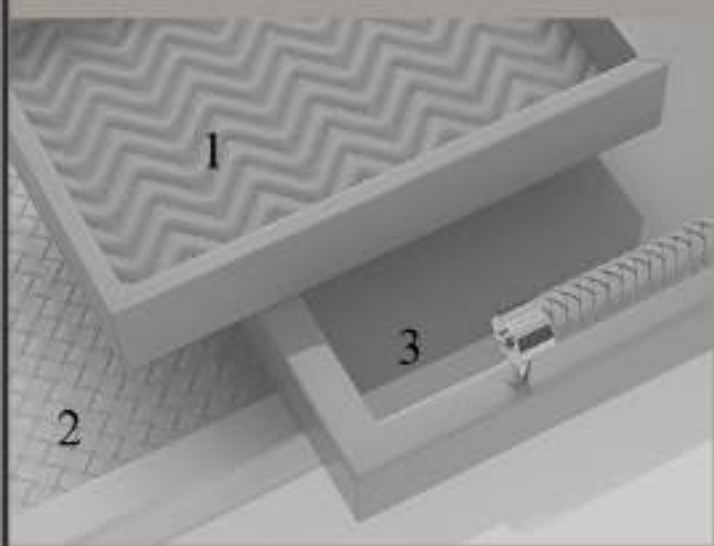

- 1 VT3-TS - small leather tray / vide-poches, quilted herringbone lining, cm 18x24
- 2 VGQ-INT - square leather tray, hand woven lining, cm 46x46
- 3 VPL/P - lacquered tray, hand woven lining, cm 46x31



# RIVIERE



1 WB-TS sm - small leather wastebasket, quilted herringbone leather on two sides, cm 20x20xh23

2 WB-TS lg - large leather wastebasket, quilted herringbone leather on two sides, cm 23x23xh30

3 PC-TS sq - square quilted herringbone leather tissue box holder

4 VT8-TS - multi purpose container box, quilted herringbone leather, cm 30x15xh12,5

5 PC-TS rect - rectangular quilted herringbone leather tissue box holder

6 BT-L - vanity tray, lacquered wood base and braided leather trim, size cm 16x32

# RIVIERE



1 LB-INT/P - woven leather laundry basket, lining in varnished wood, acrylic lid with woven leather handle, 40x30x60h.

# RIVIERE



- 1 F2-SC/EX - leather frame with inner chrome trim and outer braided trim, picture size 13x18
- 2 S1-PT/FL - leather box with quilted lining, acrylic lid with leather flower, cm. 15x15xh6,5
- 3 VGL/P - lacquered tray with hand woven leather handles, cm 60x40
- 4 PL1 - folding chrome base, h. cm 60

RIVIERE



1 LOP - oval lamp encased in hand woven leather, chrome details, oval lampshade - tot h cm 60

RIVIERE



1 F2-IM - stitched padded leather frame, picture size 13x18

2 F3-IM - stitched padded leather frame, picture size 18x24

3 VT9-IM - small leather tray / vide-poches, stitched padded leather lining, 21x26xh3

4 VT5-IM - small leather tray / vide-poches, stitched padded leather lining, 18x18xh3

# RIVIERE



1 BX2-IM - rectangular leather box, stitched padded leather, 31x22xh10,5

2 BX-IM - rectangular leather box, stitched padded leather, 27x18xh7

# RIVIERE



1 DS-BX/IM - rectangular box, stitched padded leather, 25x10xh5,5

2 DS-PP/IM - mail holder, stitched padded leather, 21x10xh9

3 DS-PC/IM - pen cup, stitched padded leather, 8x8xh11

4 DS-BL/IM - desk pad, stitched padded leather, 60x40

5 DS-PT - leather paper tray, 32,5x24xh5,5

6 DS-L/DS-M - letter opener and magnifier with woven leather handle, chrome details

# RIVIERE



- 1 WB-IM lg - large leather wastebasket, stitched padded leather on two sides, 23x23xh30
- 2 WB-IM sm - small leather wastebasket, stitched padded leather on two sides, 20x20xh23



# RIVIERE



1 VG-AR - leather tray with braided curved handles, chrome details, 40x22

# RIVIERE



1 F2-SC/EX - leather frame with inner chrome trim and outer braided trim, picture size 13x18

2 F3-SC/IN - leather frame with inner braided trim, chrome details, picture size 18x24

3 F2-SC/EX - leather frame with inner chrome trim and outer braided trim, picture size 13x18

4 F2-SC/IN - leather frame with inner braided trim, chrome details, picture size 13x18

5 BX-SC - leather box with braided leather trim and chrome details, cm 27x18x8

RIVIERE

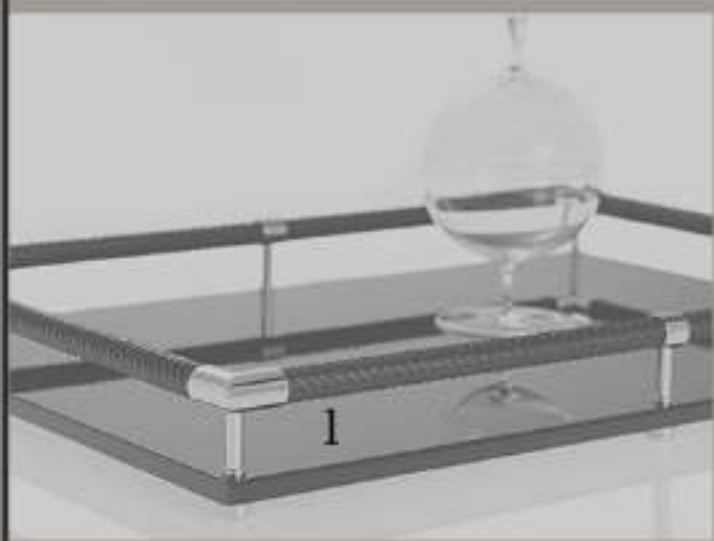

1 V-SC rect - rectangular lacquered tray with hand braided leather railing, chrome details, cm 35x50

# RIVIERE



1 VGQ-LP - square laquered tray with leather frame, cm 46x46  
2 VPQ-LP - square lacquered tray with leather frame, cm 37x37

3 VT5-TF - small leather tray / vide-poches with quilted lining floral decor, cm 18x18  
4 B-INT - scented candle with removable woven leather cover, h cm 9 ø cm 8

5 S1-CF - leather box with carved acrylic lid, floral decor, cm 15x15xh6,5

# RIVIERE



1 S4-PT/FL - leather box with quilted lining, acrylic lid with leather flower, cm 17x17xh8,5

2 S1-PT/FL - leather box with quilted lining, acrylic lid with leather flower, cm 15x15xh6,5

3 VT2-PT - small leather tray / vide-poches, quilted padded lining, cm 11x35

4 VT3-PT - small leather tray / vide-poches, quilted lining, cm 18x24

5 VT1-PT - small leather tray / vide-poches, quilted lining, cm 15x15

6 B-PT - scented candle with removable quilted leather cover, h cm 9, ø cm 8

RIVIERE

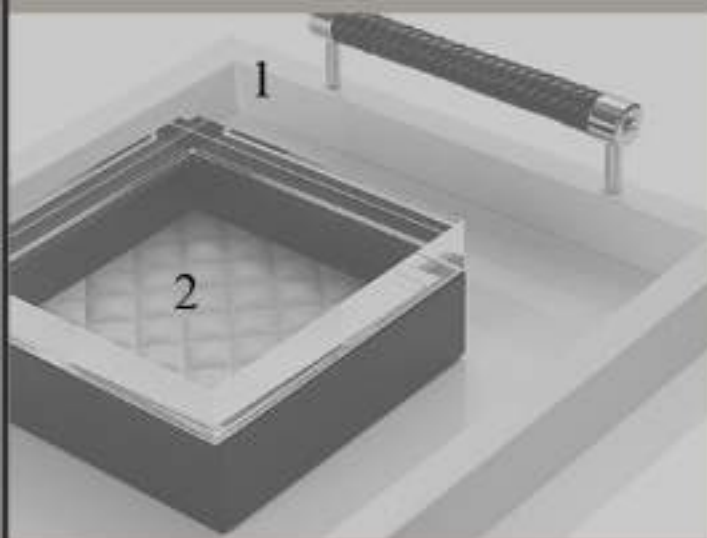

- 1 VPL/P - lacquered tray with hand woven leather handles, cm 46x31  
2 S1-PT - leather box with quilted lining, plain acrylic lid, cm 15x15xh6,5

# RIVIERE



1 F2-INT - woven leather frame, picture size cm 13x18

2 VGQ-SP - square leather tray with herringbone lining, cm 46x46

3 VT3-SP - small leather tray /vide-poches with herringbone lining, cm 18x24

4 VPQ-INT - square leather tray with hand woven lining, cm 37x37

RIVIERE



1 VGL/BP - lacquered tray with leather covered bamboo handles, cm 60x40



# RIVIERE



1 LC1 - ivory enamelled cylindrical lamp covered with hand braided ivory leather, cylindrical shade, tot h cm 65

2 LC2 - chromed cylindrical lamp covered with hand braided leather (black, choc brown or taupe), cylindrical shade, tot h cm 65

# RIVIERE

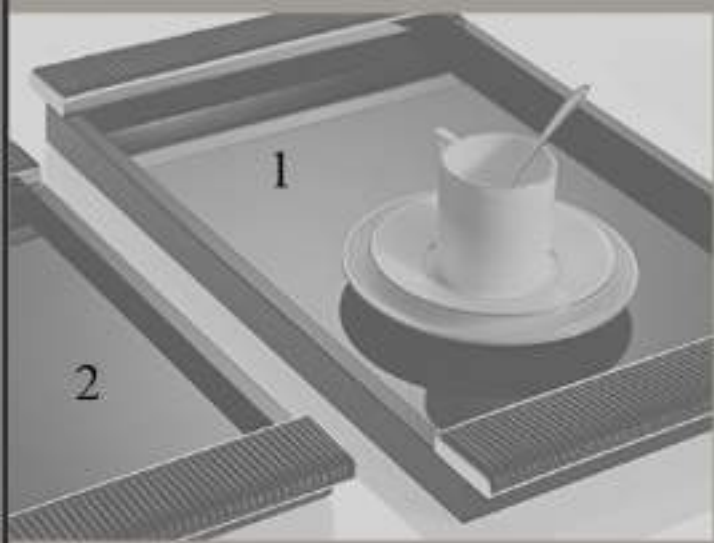

1 VGD-L lacquered tray with leather wrapped / chrome handles, cm 26x39

2 VPD-L lacquered tray with leather wrapped / chrome handles, cm 20x30

# RIVIERE



- 1 F2-SC/EX g - leather frame, gold metal trim and outer braided trim, picture size 13x18
- 2 S1-PT/FL - leather box, quilted padded lining and leather flower (camelia), 15x15xh6,5
- 3 VGL/P g - lacquered tray with hand woven leather handles, gold details, 60x40
- 4 PL1 g - folding gold metal legs for large tray 60x40, h60

# RIVIERE



- 1 F2-BL g - leather frame with "belt" decoration, gold details, picture size 13x18
- 2 F3-BL g - leather frame with "belt" decoration, gold details, picture size 18x24

# RIVIERE



- 1 VG-ST g - leather tray with braided leather plate handles, gold details, 50x35
- 2 VGD/L g - lacquered tray wth leather wrapped/gold metal handles, 26x39
- 3 VPD/L g - lacquered tray wth leather wrapped/gold metal handles, 20x30
- 4 VPL/P g - lacquered tray with hand woven leather handles, gold details, 46x31
- 5 BT-L g - vanity tray, lacquered wood base and braided leather trim, gold metal details, 16x32

RIVIERE



1 T1-INT - side table with woven leather top (cm 50x70) - chromed metal legs, adjustable height (cm 45 / cm 60)

# RIVIERE

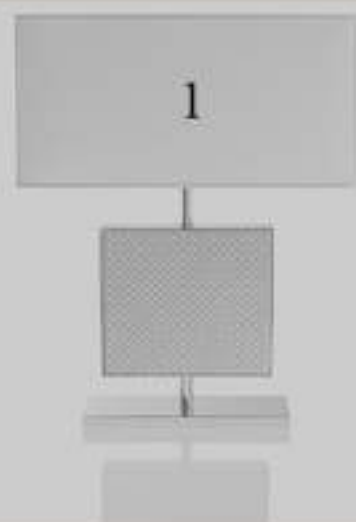

1 LR2-INT - lamp with woven leather on two sides and chrome trim, chrome base, cm 31x10xh65

# RIVIERE



1 F2-INT - woven leather frame, picture size cm 13x18

2 F3-INT - woven leather frame, picture size cm 18x24

3 VGL/P - lacquered tray with hand woven leather handles, cm 60x40

4 S1-PT/FL - leather box with quilted lining, acrylic lid with leather flower, cm. 15x15xh6,5

5 S4-PT/FL - leather box with quilted lining, acrylic lid with leather flower, cm. 17x17xh8,5

6 VT3-PT - small leather tray / vide-poches, quilted lining, cm. 18x24

7 VPL/P - lacquered tray with hand woven leather handles, cm 46x31



# RIVIERE



1 V3-PDV - bone china vase with removable hand braided leather cover, h cm 30 ø cm 12

2 V2-PDV - bone china vase with removable hand braided leather cover, h cm 26 ø cm 10

3 V1-PDV - bone china vase with removable hand braided leather cover, h cm 22 ø cm 8

4 B-PDV - scented candle with removable braided leather cover, h cm 9 ø cm 8

# RIVIERE

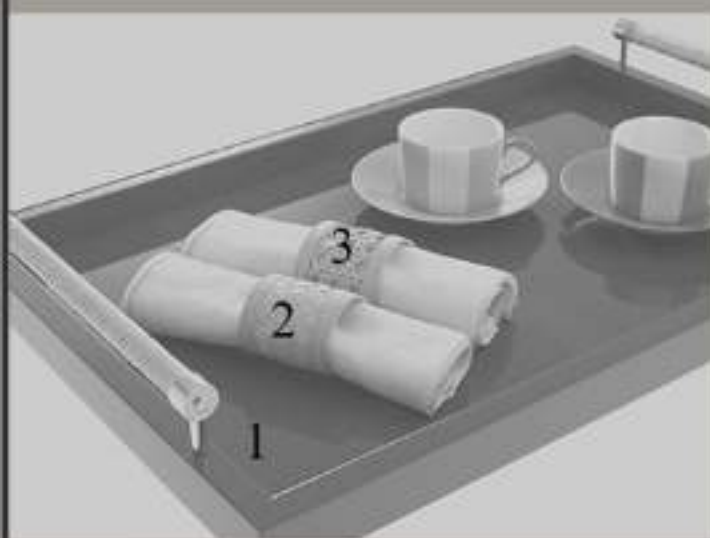

1 VGL/P - lacquered tray with hand woven leather handles, cm 60x40

2 LT-INT - woven leather napkin ring

3 LT-PDV - braided leather napkin ring

RIVIERE

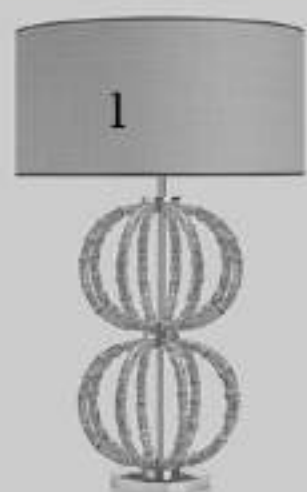

1 LB3 - large bamboo lamp with chrome base, cylindrical shade in natural straw ø cm 50, tot h cm 85

# RIVIERE

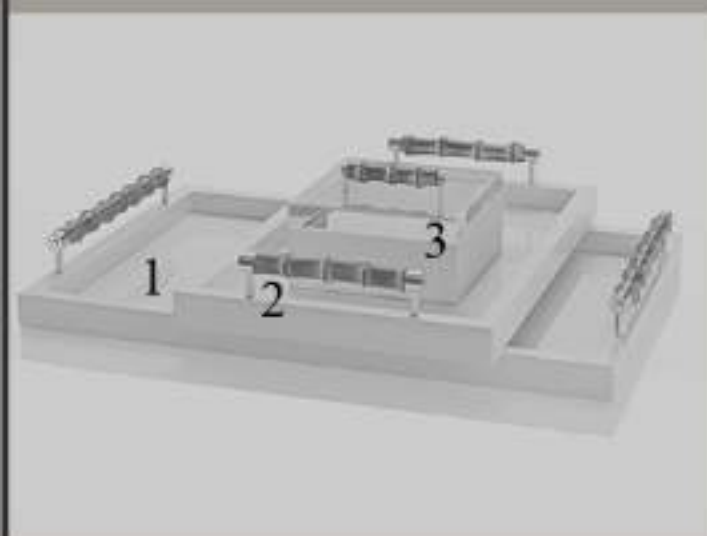
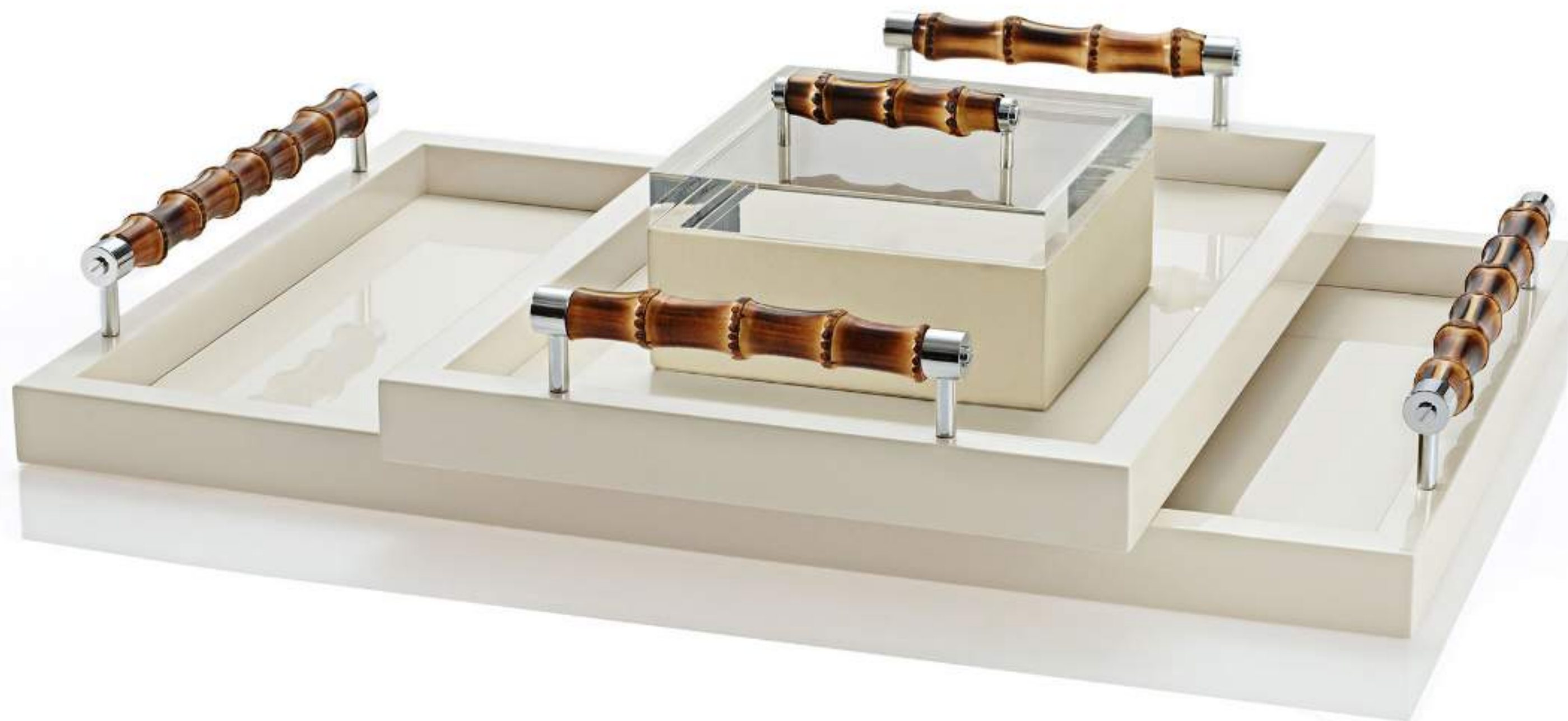

1 VGL/B - lacquered tray with bamboo handles, cm 60x40

2 VPL/B - lacquered tray with bamboo handles, cm 46x31

3 S4-PT/B - leather box with quilted lining, acrylic lid, bamboo handle, cm 17x17xh8,5

# RIVIERE



1 F3-B4 - leather frame with bamboo details, picture size cm 18x24

2 F3-BB - leather frame with bamboo trimming, picture size cm 18x24

3 F1-B4 - leather frame with bamboo details, picture size cm 10x15

4 F2-BB - leather frame with bamboo trimming, picture size cm 13x18

5 VT2-PT/B2 - small leather tray / vide-poches with quilted lining and bamboo handles cm 11x35

6 VT3-PT/BB - small leather tray / vide-poches with quilted lining and bamboo trimming cm 18x24

7 VT1-PT/BB - small leather tray / vide-poches with quilted lining and bamboo trimming cm 15x15

8 VT3-PT/B2 - small leather tray / vide-poches with quilted lining and bamboo handles cm 18x24

# RIVIERE

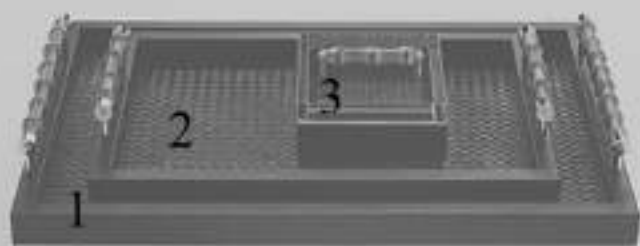

1 VG-INT/B - leather tray, hand woven lining, bamboo handles, cm 60x40

2 VP-INT/B - leather tray, hand woven lining, bamboo handles, cm 46x31

3 S1-INT/B - leather box with hand woven padded lining, acrylic lid and bamboo handle, cm 15x15xh6,5

# RIVIERE



1 F1-B4 - leather frame with bamboo details, picture size cm 10x15

2 F1-BB - leather frame with bamboo trimming, picture size cm 10x15

3 F2-BB - leather frame with bamboo trimming, picture size cm 13x18

4 VT3-PT/BB - small leather tray / vide-poches with quilted lining and bamboo trimming cm 18x24

5 VT1-PT/BB - small leather tray / vide-poches with quilted lining and bamboo trimming cm 15x15

# RIVIERE



1 LB1 - bamboo table lamp with chrome base, tot h cm 58, cylindrical shade in black linen, diam cm 50 (also available in parchment or natural straw shade)



# RIVIERE



- 1 F3-PT - quilted leather frame, chrome trimming, picture size cm 18x24
- 2 F2-PT - quilted leather frame, chrome trimming, picture size cm 13x18
- 3 F1-PT - quilted leather frame, chrome trimming, picture size cm 10x15

# RIVIERE

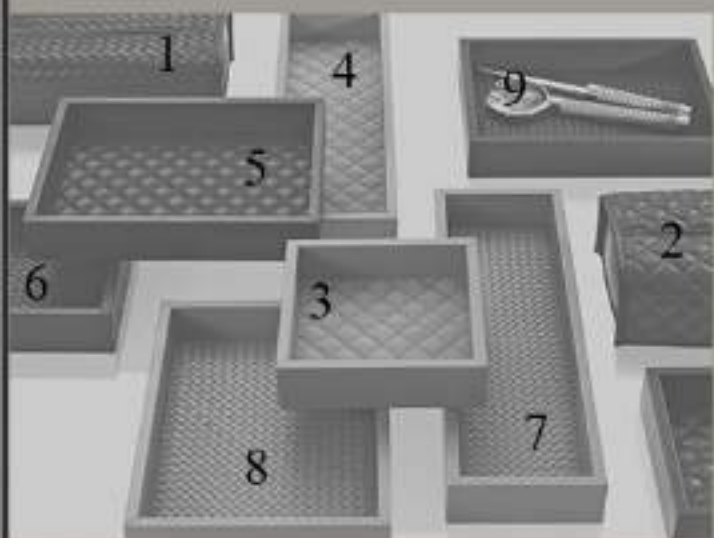

**1 PC-INT RECT** - rectangular hand woven leather tissue box holder

**2 PC-PT RECT** - rectangular quilted leather tissue box holder

**3 VT1-PT** - small leather tray / vide-poches with quilted lining, cm 15x15

**4 VT2-PT** - small leather tray / vide-poches with quilted lining, cm 11x35

**5 VT3-PT** - small leather tray / vide-poches with quilted lining, cm 18x24

**6 VT1-INT** - small leather tray / vide-poches, hand woven padded lining, cm 15x15

**7 VT2-INT** - small leather tray / vide-poches, hand woven padded lining, cm 11x35

**8 VT3-INT** - small leather tray / vide-poches, hand woven padded lining, cm 18x24

**9 DS-L, DS-M** - letter opener and magnifier with hand braided leather handles

# RIVIERE



- 1 BH-INT lg - bottle holder, hand woven leather, large, h. 18, ø 10
- 2 BH-INT sm - bottle holder, hand woven leather, small, h. 14, ø 8

# RIVIERE

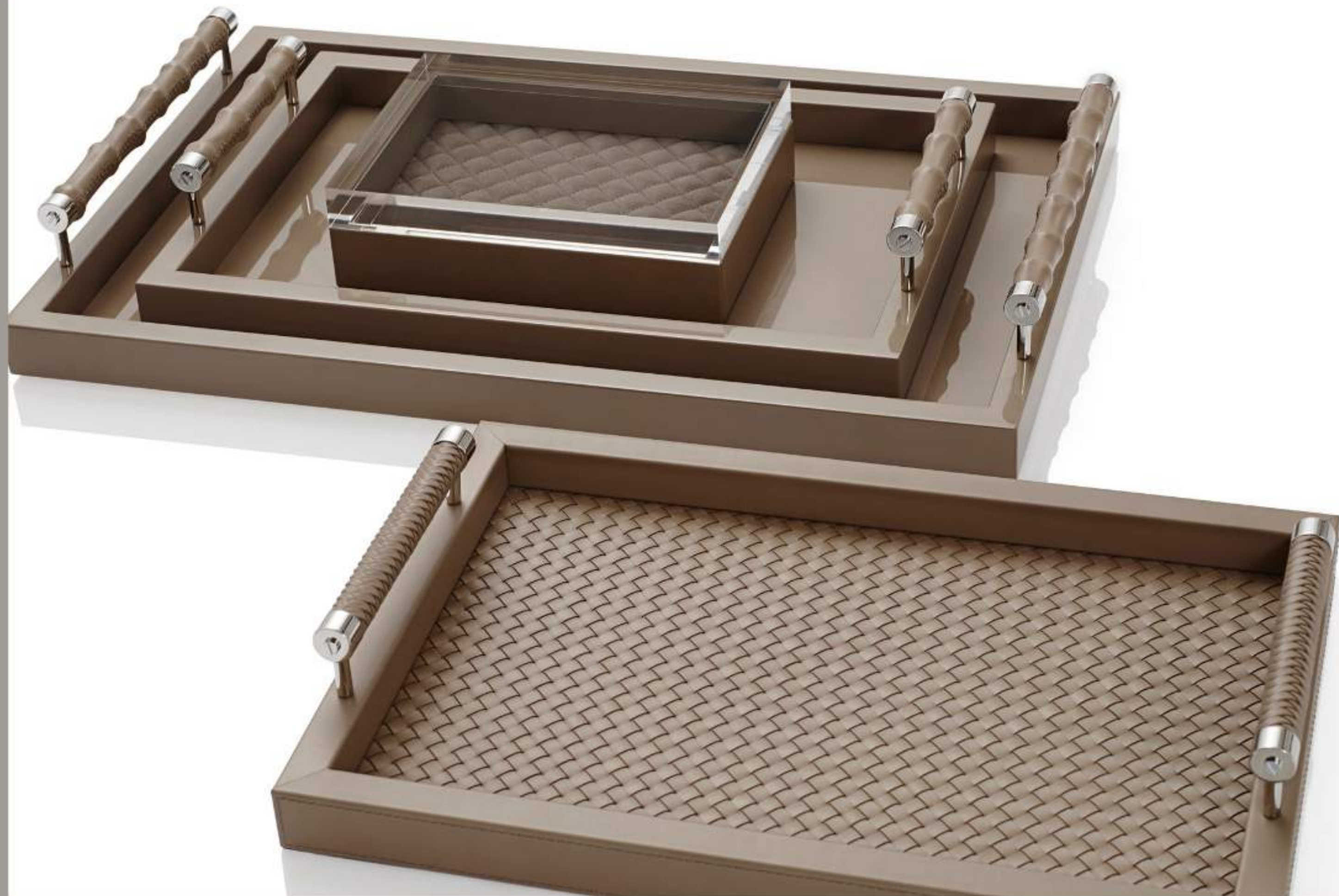

**1** VGL/BP - lacquered tray with leather covered bamboo handles, cm 60x40

**4** VP-INT/P - leather tray with hand woven lining, hand woven leather handles, cm 46x31

**2** VPL/BP - lacquered tray with leather covered bamboo handles, cm 46x31

**3** S3-PT - leather box with quilted lining, acrylic lid, cm 18x24x6,5

# RIVIERE



1 V3-INT - bone china vase with removable hand woven leather cover h cm 30, ø 12

4 B-INT - scented candle with removable hand woven leather cover h cm 9, ø 8

2 V2-INT - bone china vase with removable hand woven leather cover h cm 26, ø 10

3 V1-INT - bone china vase with removable hand woven leather cover h cm 22, ø 8

RIVIERE



1 LR2-TS - lamp with quilted herringbone leather on two sides and chrome trim, chrome base, cm 31x10xh65

# RIVIERE

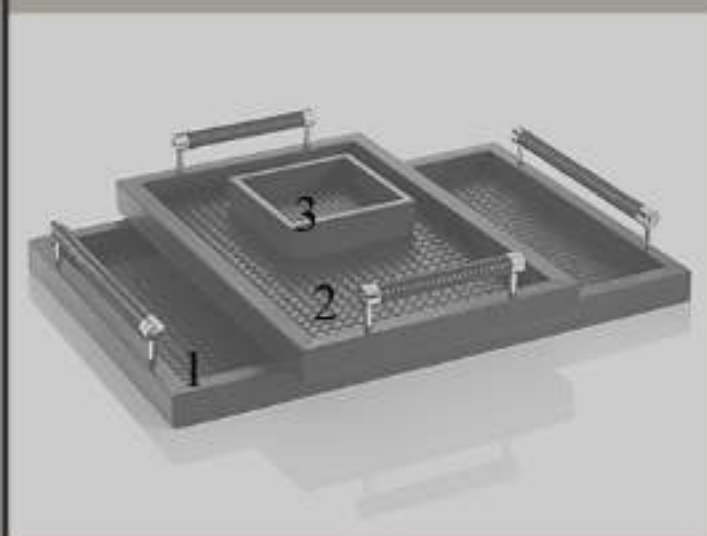

- 1 VG-INT/P - leather tray with hand woven lining, hand woven leather handles, cm 60x40
- 2 VP-INT/P - leather tray with hand woven lining, hand woven leather handles, cm 46x31
- 3 VT1-INT - small leather tray/vide-poches, hand woven padded lining, cm 15x15

# RIVIERE



1 ST-INT - folding stool / luggage rack, hand woven leather seat, cm 35x48x47h



RIVIERE



1 LC4-INT - cylindrical lamp covered with hand woven leather, cylindrical shade, tot h cm 65

# RIVIERE

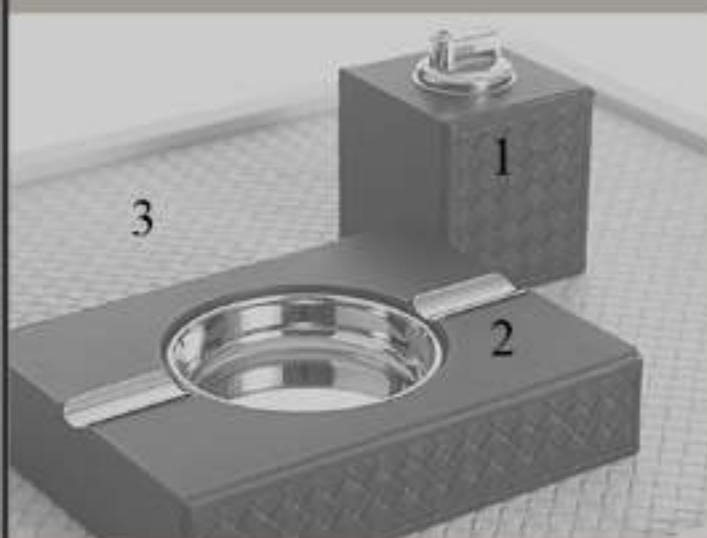

1 TL-INT - table lighter, woven leather, cm 8x8xh9

2 CA-INT - cigar ashtray, woven leather, cm 21x15xh4,5

3 VGQ-INT - square tray with woven leather lining and leather frame, cm 46x46

# RIVIERE

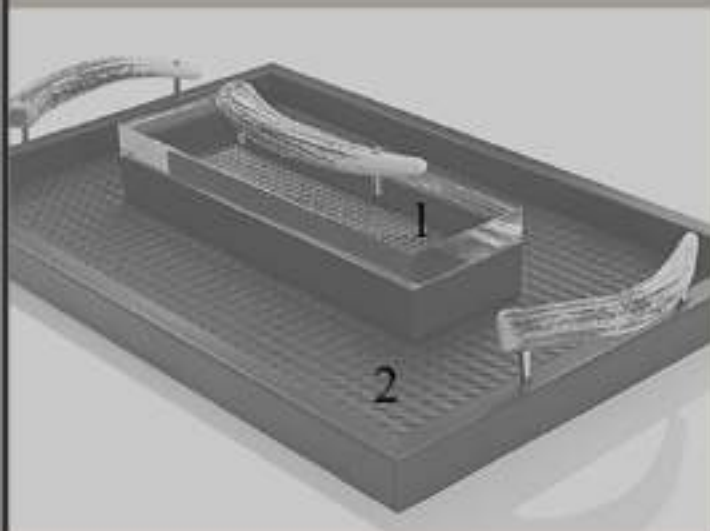

1 S2-INT/C - leather box with hand woven padded lining, acrylic lid and deer-horn handle, cm 11x35xh6,5

2 VG-INT/C - leather tray hand woven lining, polished deer-horn handles, cm 60x40

# RIVIERE



1 VGQ-EP - square tray with stitched leather lining and Macassar ebony frame, cm 46x46

2 VPQ-EP - square tray with stitched leather lining and Macassar ebony frame, cm 37x37

3 VGQ-EINT - square tray with hand woven leather lining and Macassar ebony frame, cm 46x46

4 VPQ-EINT - square tray with hand woven leather lining and Macassar ebony frame, cm 37x37

5 S3-CX - leather box with carved acrylic lid, basket-wave decor, cm 18x24xh6,5

6 B-INT - woven leather candle holder, with removable scented candle, size h cm 9 ø cm 8

RIVIERE



1 CBX-E - Makassar ebony cigar box humidior with hand braided leather inlay and cedar wood lining, 50 cigars, cm 30x24x14

2 BX-E - Makassar ebony box with hand braided leather inlay, leather lining. cm 29x20x9

RIVIERE



1 CBX-E - macassar ebony cigar box humidor with hand braided leather inlay and cedar wood lining, 50 cigars, cm 30x24x14

RIVIERE



1 DSC/PC - pen cup, quilted striped leather, cm 8x8xh11  
2 DSC/PP - mail holder, quilted striped leather, cm 21x10xh9

3 DSC/BX - rectangular box, quilted striped leather, cm 25x10xh5,5  
4 DSC/BL - desk pad, quilted striped leather, cm 60x40

5 DS-L/M - letter opener and magnifier set with hand braided leather handles  
6 DS-PT - paper tray, cm 32,5x24xh5,5

# RIVIERE



1 LOE - oval lamp, Makassar ebony and chrome base, oval parchment shade, tot h cm 60

2 VPQ-INT - square leather tray, hand woven lining, cm 37x37

3 VT1-EINT - small Makassar ebony tray, hand woven leather lining, cm 15x15

4 PC-INT - RECT rectangular hand woven leather tissue box holder

5 VGQ-INT square leather tray, hand woven, cm 46x46

6 S3- EP Makassar ebony box with quilted padded leather lining and acrylic lid, cm 18x24xh6,5



# RIVIERE

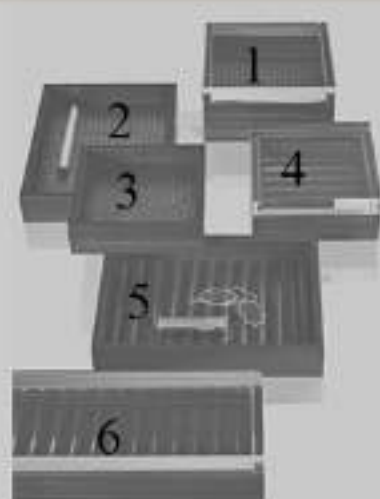

1 S4-EINT - Makassar ebony box, hand woven padded black leather lining, acrylic lid, cm 17x17xh8,5

2 VT3-EINT - small Makassar ebony tray, hand woven leather lining, cm 18x24

3 VT1-EINT - small Makassar ebony tray, hand woven leather lining, cm 15x15

4 S1-EP - Makassar ebony box quilted padded black leather lining, acrylic lid, cm 15x15xh6,5

5 VT3-EP - Makassar ebony tray, quilted padded black leather lining, cm 18x24

6 S2-EP - Makassar ebony box quilted padded black leather lining, acrylic lid, cm 11x35xh6,5

RIVIERE



1 S3-EINT/P - Makassar ebony box, hand woven black leather lining, acrylic lid with hand woven handle, cm 18x24xh6,5

# RIVIERE



1 VGE/P - Makassar ebony tray with hand woven leather handles, cm 60x40

2 VPE/P - Makassar ebony tray with hand woven leather handles, cm 46x31

# RIVIERE

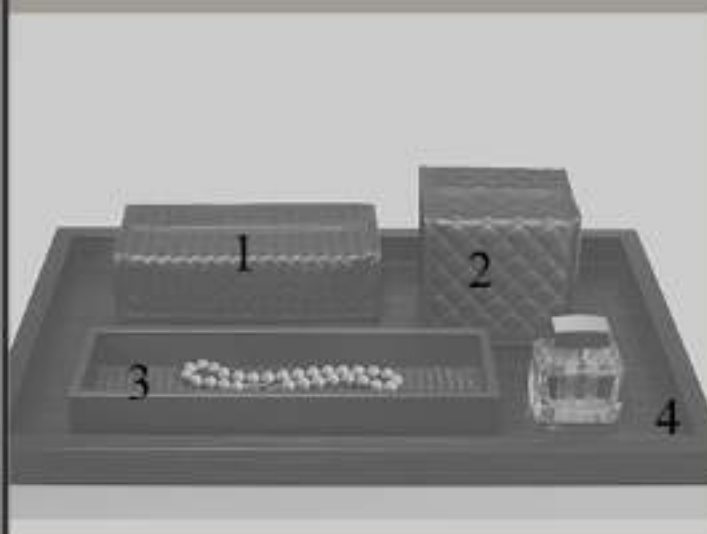

1 PC-INT rect - rectangular hand woven leather tissue box holder

2 PC-PT sq - square quilted leather tissue box holder

3 VT2-INT - small leather tray / vide-poches, hand woven padded lining, cm 11x35

4 VGE - Makassar ebony tray, cm 60x40

outdoor collection



# RIVIERE

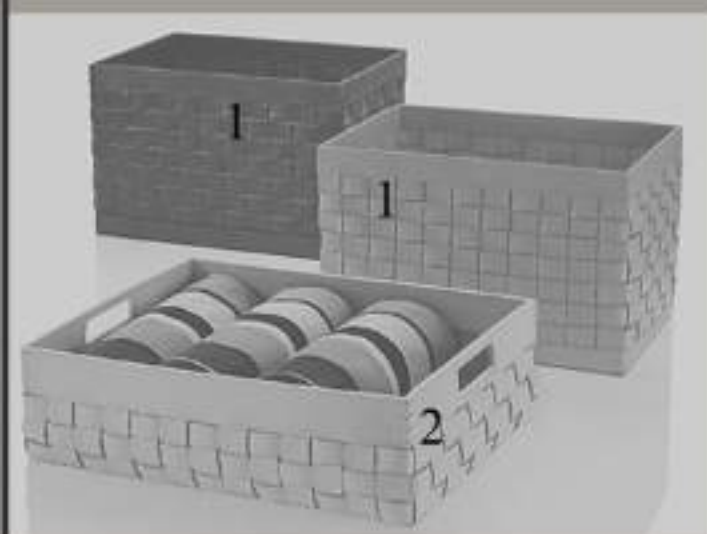

1 BK1-rect - rectangular basket, woven leather, cm 35x50xh32

2 BK2-rect - rectangular basket, woven leather, cm 62x45xh18

# RIVIERE

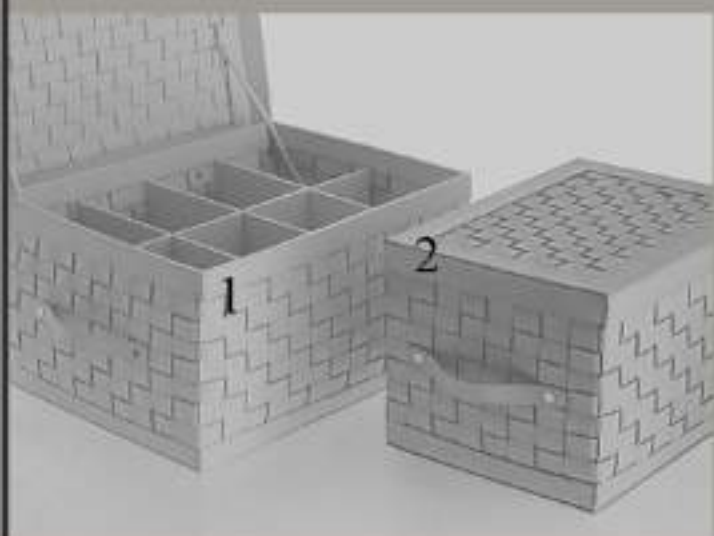

1 BK-SH/8 - shoe trunk (8 pairs), woven leather, cm 62x45xh33

2 BK-SH/6 - shoe trunk (6 pairs), woven leather, cm 50x35xh33

RIVIERE



1 BK-LB - large round basket / laundry basket with lid, woven leather, ø 42 h49



# RIVIERE



1 BK-VT3 - rectangular tray, woven leather, cm 25x19xh6

2 BK-VT8 - multi purpose rectangular holder, woven leather, cm 29x14xh13

# RIVIERE



1 BK-PC rect - tissue box cover, woven leather, rectangular, 25x13,5x9 h.

2 BK-PC sq - tissue box cover, woven leather, square, 13x13x13,5 h.

RIVIERE

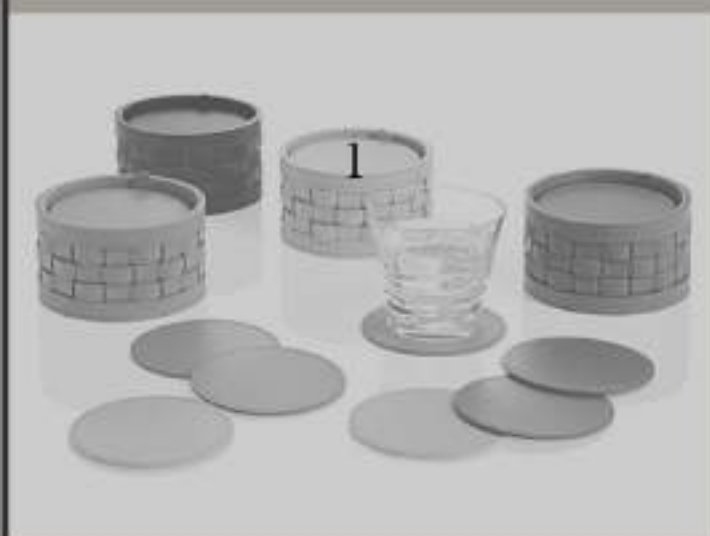

1 BK-CS - set of 10 leather coasters in woven round box ø 12 h7

RIVIERE

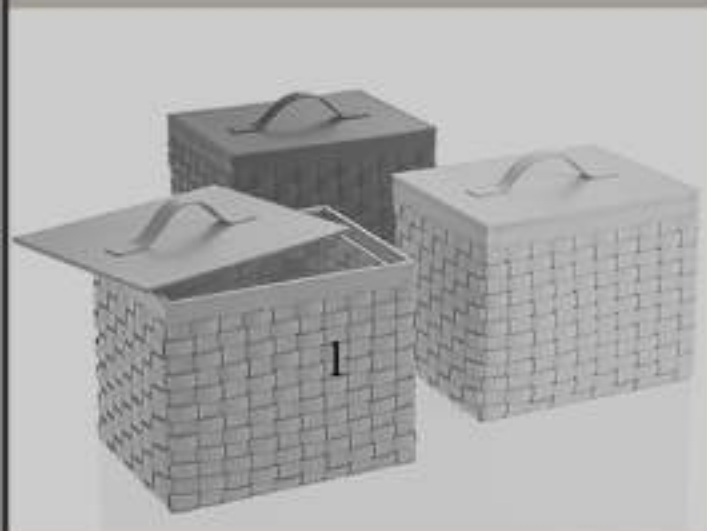

1 BK-BX1 - rectangular box / small wastebasket with lid and acrylic lining, woven leather, 26x20xh20

# RIVIERE



- 1 BK round lg - cylindrical basket, woven leather, diam cm 32 x h35
- 2 BK round sm - cylindrical basket, woven leather, diam cm 27 x h30

All information contained in our price lists and catalogs are strictly confidential.  
All image, brand and logo rights are reserved, therefore any use or publishing of the same is  
strictly forbidden unless agreed in written with the Seller.

R I V I E R E ©  
All rights reserved

CHLEO International, Via Melegnano 22, 20019 - Settimo Milanese (Mi) Italy, Ph. +39 0233591295 - Fax. +39 0233590486  
[www.rivierestyle.it](http://www.rivierestyle.it) - [info@chleo.it](mailto:info@chleo.it)