

reflex

GLAMOUR



G L A M O U R

reflex
GLAMOUR

PROJECTS

i n t e r i o r s

4	CONTEMPORARY LUXURY
18	BELLE EPOQUE VILLA
24	HISTORICAL VILLA
34	LUXURY FLAT
46	RESORT
60	ELEGANCE SUITE



Glamour

C O N T E M P O R A R Y
L U X U R Y

UNIQUENESS, DISTINCTION,
ETERNITY, TIME, SPACE:
EXCLUSIVE DESIGN AND
PRECIOUS MATERIALS
COMBINED WITH
THE CANONS OF ITALIAN'S
TASTE TO CREATE A
LEVEL OF COMFORT THAT
CAN ONLY BE DEFINED
CONTEMPORARY LUXURY







*CASANOVA
sofa*



DIAMANTE COMPOSIZIONE



SASSI 40



*NAUTILUS 72
tavolo*



*LEAF
lampadario*



*GRAN CANAL 55
terminale*

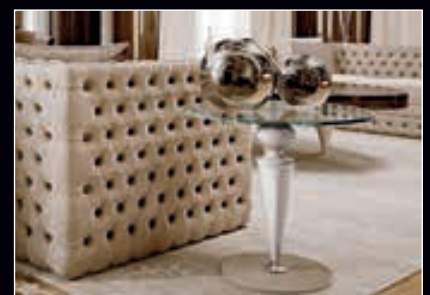







*AVANTGARDE
sofa*



*GRAN CANAL 40
tavolino*



*GRAN CANAL
piantana*



*BASTIDE
sedie*



*BULLES XL
lampadario*

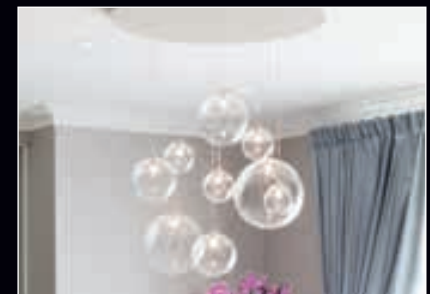

*LUCE
scrivania*













Glamour

BELLE EPOQUE VILLA

THE NEW REFLEX COLLECTION IS INSPIRED BY THE ART OF BEGINNING '900, IN PARTICULAR BY THE FUTURISTIC TREND. THIS MODERN AND ELEGANT COLLECTION CAN BE USED IN DIFFERENT LOCATIONS. THE GEOMETRIC SHAPES AND THE DYNAMIC LINES OF THE ARTISTIC TREND CREATE NEW PRODUCTS WITH STRONG AND ELEGANT CHARACTERISTICS. THE FINE MATERIALS GIVE VALUE TO THE COLLECTIONS AND CREATE A PARTICULAR VISUAL AND EMOTIONAL INTERACTION.







*BELLE EPOQUE
bar cocktail*



*BELLE EPOQUE
cucina*



BELLE EPOQUE 72



*BELLE EPOQUE
sofa*



ICE lampadario





Glamour

HISTORICAL VILLA

A EIGHTEENTH-CENTURY HOUSE WITH GLAMOUR BROAD SPACES LOOKING AT THE LAKE'S RIVERS. IT IS EQUIPPED WITH CLASSIC STYLE FURNITURE, ENHANCED BY THE CRYSTAL TRANSPARENCE AND THE TIMELESS ELEGANCE OF GOLD.







AVANTGARDE TV

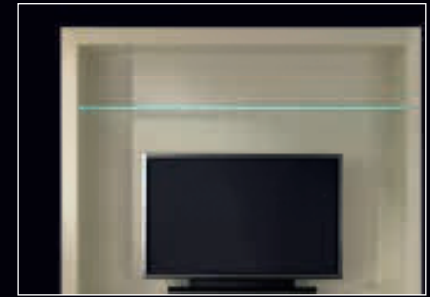

CASANOVA sofa



SASSI 40



CASANOVA 55



CASANOVA lampadario



TERRA applique

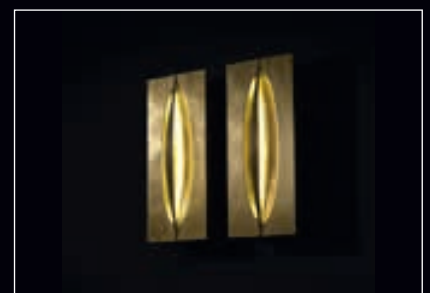



FLAMBE' 72



PEGGY ALTA



AVANTGARDE
libreria composizione

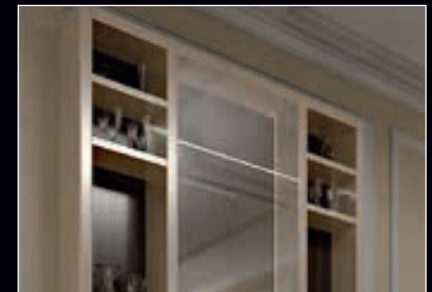

AVANTGARDE libreria 0



CASANOVA buffet

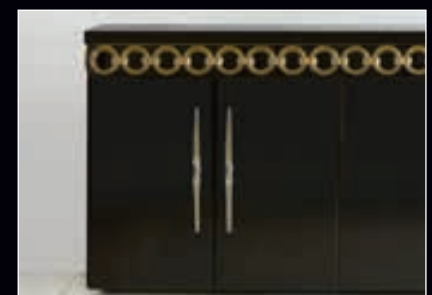

STELLA lampadario

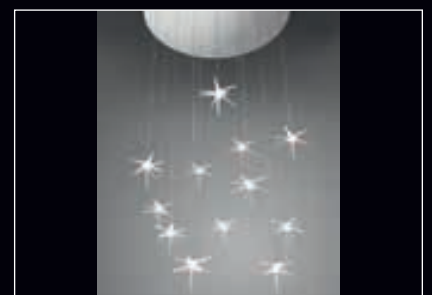



*CASANOVA
mobile console*



CASANOVA specchio



VASO RIGATO ZUCCA



SASSI scultura





Glamour

L U X U R Y F L A T

FLAT WITH BROAD
WINDOWS LOOKING
AT THE PARK. THE USE
OF THE PADDED ITEMS,
VELVETS, THE EBONY AND
THE GREAT FIREPLACE
ARE PROJECT CHOICES
AIMED TO THE GREAT
COMFORT RESEARCH.







*AVANTGARDE
libreria composizione*



CA' D'ORO sofa



*GRAN CANAL 40
special*



PERSHING



FOULARD 50 e 60

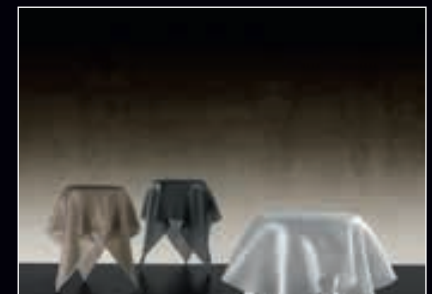

GRAN CHARLESTON

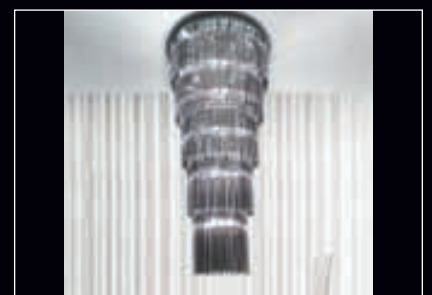



NAUTILUS 72 special

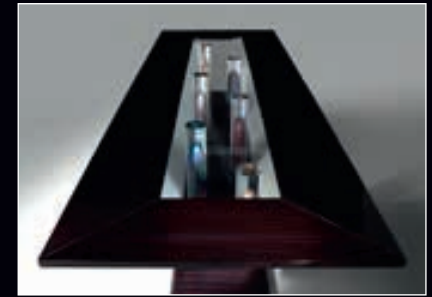

NEW YORK XL



*AVANTGARDE
credenza luce*



PRISMA specchio TV



SIRIUS lampadario

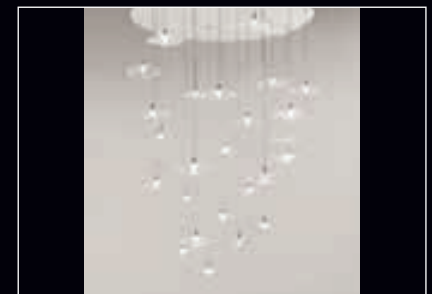

*GRAN CANAL
piantana*

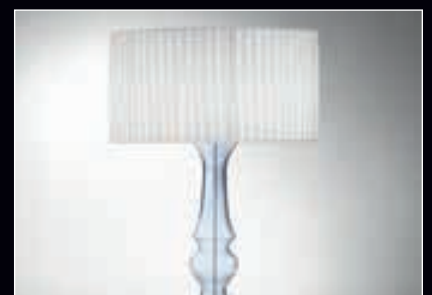



CA' D'ORO madia



GRAN CANAL console



CASANOVA specchio

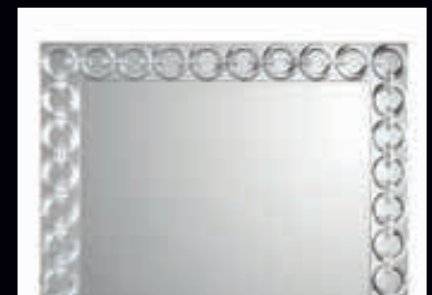

*NEOLITICO portafrutta
(catalogo Disegno)*





CHARLESTON applique

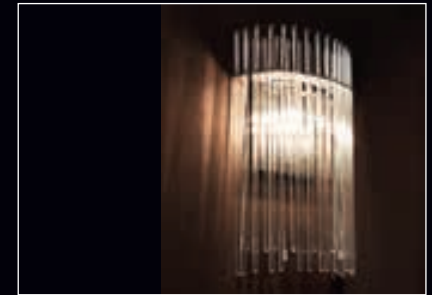

GRAN CANAL lampada



*AVANTGARDE
console long*



GRAN CANAL 55





Glamour

R E S O R T

THE CHALLENGE OF FURNISHING AN ELEGANT SPACE IN A BARREN AND WILD ENVIRONMENT IS SOLVED AS A MATERIAL PERMEATION, COLOURS AND FURNITURE CHOICES ARE MELTED WITH THE NATURE OF THE SCENERY.







*AVANTGARDE
credenza low*



AVANTGARDE SOFA

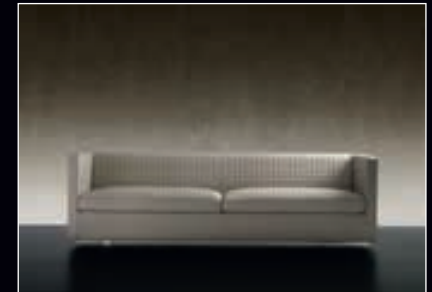

*BAMBOO 40
(catalogo Disegno)*



LUCCIOLA tavolino



DUNE luce h.140



BULLES lampadario





*TRANSEO 72 CRAQUE-
LE'*



NEW YORK



MURANO buffet



PRISMA specchio tv



LUCCIOLA piantana





GIANO modulare



LUCE scrivania



PEGGY



TITANIUM



CASANOVA lampadario



NEOLITICO console oro





TERRA piantana

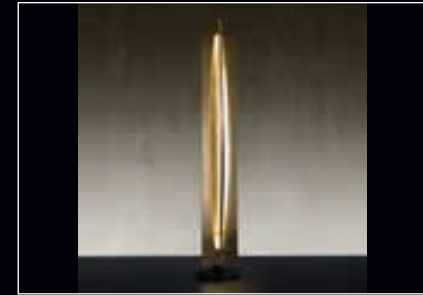

BILL



GIANO buffet



CA' D'ORO specchio



CHARLESTON ovale

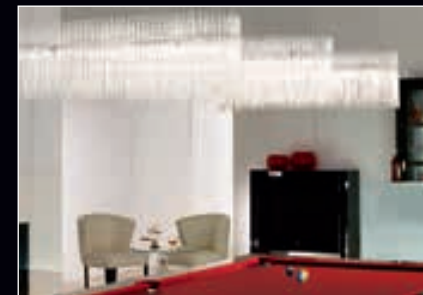



ANDROMEDA 40



REGLAX
(catalogo Disegno)



MING VASO
(catalogo Disegno)





Glamour

ELEGANCE SUITE

THE ATTENTION TO THE
DETAIL AND PRECIOUS
COMBINATIONS MAKE
THE ELEGANCE AS THE
PROJECT DISTINCTIVE
FEATURE. THE LUXURY
SHOWN IN THE BATHROOM
AND IN THE WARDROBE
IS CONTAINED IN A
SPACE PERCEIVED FROM
THE BEDROOM WHERE
THE SOFTNESS OF THE
MATERIALS AND OF
THE SHADES MAKES A
RELAXING AND INTIMACY
COUNTERPOINT.







PLISSÉ XL
(catalogo Notte)

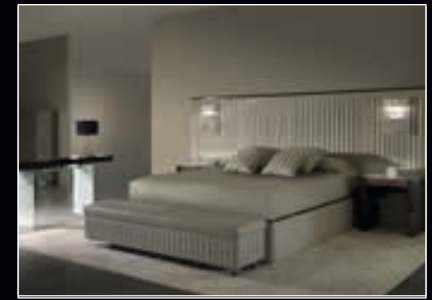

RIALTO comodino
(catalogo Notte)



RIALTO como'
(catalogo Notte)



BOUQUET collezione



CASANOVA madia

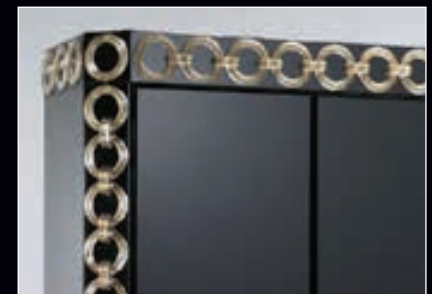

AVANTGARDE toilette





FIOCCO



CASANOVA console



BASTIDE poltroncina



SCACCHI



CASANOVA armadio



*CASANOVA comò
(catalogo Notte)*





CASANOVA triclinio



CASANOVA SPA



CASANOVA specchio



LEAF lampadario

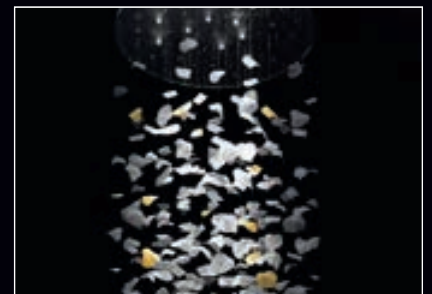

TAVOLI

DINING TABLES

132	ANDROMEDA 72
105	ARLEQUIN 72
121	BAMBOO 72
122	BAMBOO 72 BEVEL WOOD
98	BELLE EPOQUE 72
135	BILL
110	BOLSHÒJ 72
133	CA' D'ORO 72
74	CASANOVA 72
72	CASANOVA 72 SPECIAL
85	CORALLO 72
101	FILI D'ERBA 72
80	FLAMBÉ 72
146	GALASSIA 72
117	GRAN CANAL 72
118	GRAN CANAL 72 LEGNO
125	IMPACT 72
130	INFINITO VETRO MARMO
89	NAUTILUS 72 SPECIAL
112	NEOLITICO 72
114	NEOLITICO 72 VETRO
142	PARENTESIS 72
140	POKER
96	SASSI 72
137	SASSI 72 SPECIAL
94	SCACCHI
144	SIGNORE DEGLI ANELLI STEEL
128	TRANSEO 72 CRAQUELE'
108	TORSADES 72

CASANOVA 72 SPECIAL

Disegno Reflex

Tavolo pranzo con base composta da 6, 8 o 12 gambe in vetro di Murano lavorate a mano, disponibili nelle finiture trasparente o oro zecchino. Zoccolo in specchio fumé spessore 35mm con bordi a becco di civetta. Piano in vetro extrachiaro spessore 15mm con bisello 45° con fascia perimetrale con incisioni Boheme opzionale.

Dining table with base made up of 6, 8 or 12 legs in Murano glass, transparent or pure-gold finish. Plinth in smoked mirror glass 35mm thick with bullnose-bevelled edges. Top in 15mm thick extra clear glass with 45° bevel with perimeter band with Boheme engravings as option.





TAVOLI / DINING TABLES

CASANOVA 72

Disegno Reflex

Tavolo pranzo con gambe in vetro di Murano lavorate a mano, realizzate in vetro trasparente o in oro zecchino. Base in vetro specchio fumé. Top in cristallo extrachiario spessore 15mm con bisello 45°.

Dining table with handmade Murano glass legs, available in transparent or fine gold finish. Plinth in smoked mirror glass. Top in extra clear glass 15 mm thick with 45° bevel.





TAVOLI / DINING TABLES

CASANOVA 72

Disegno Reflex





TAVOLI / DINING TABLES

CASANOVA 72

Disegno Reflex

Tavolo pranzo con gambe in vetro di Murano lavorato a mano. Zoccolo in vetro specchio fumé. Versione con base a 5 gambe in oro zecchino con piano in cristallo extrachiaro spessore 15mm con incisioni Diamante.

Dining table with legs in handmade Murano glass. Plinth in smoked mirror glass. Version with base with 5 legs in fine gold finish and top in extra clear glass 15mm thick with 45° bevel and Diamante engravings.



piano • top

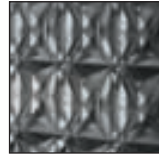

gambe • legs



special

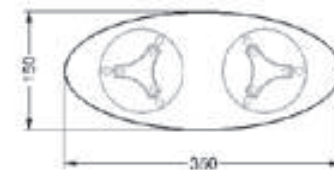
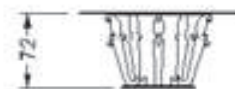
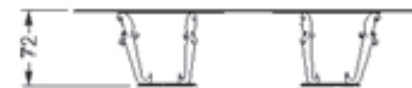
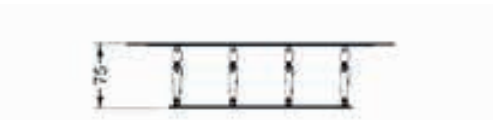
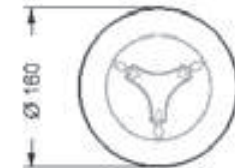
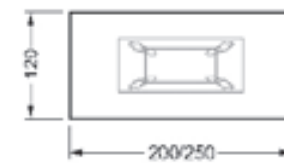
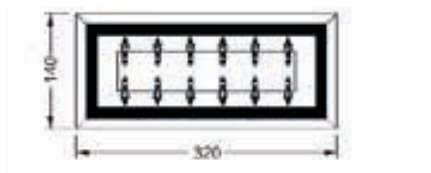
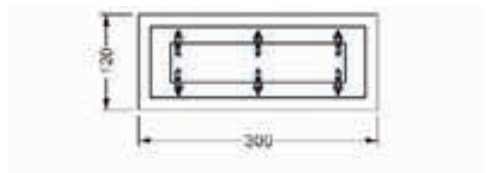
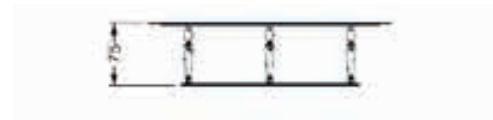

TAVOLI / DINING TABLES

FLAMBE' 72

Disegno Riccardo Lucatello

Tavolo pranzo con basamento in vetro di Murano lavorato a mano trasparente o oro zecchino. Disponibile anche in colori speciali su richiesta. Zoccolo in vetro specchio fumè. Piano in vetro extrachiario spessore 15mm.

Dining table with base in handmade Murano glass, transparent or fine gold. Also available in special colours on request. Plinth in smoked mirror glass. Top in 15mm thick extra clear glass.





FLAMBE' 72

Disegno Riccardo Lucatello

Tavolo in versione 12 elementi in vetro di Murano trasparente. Disponibile anche in oro zecchino o in altri colori speciali a richiesta. Zoccolo in vetro specchio fumé. Piano in cristallo extrachiaro spessore 15mm con bisello 45° e con incisioni Diamante. Lazy Susan con incisioni Diamante e sezione centrale a specchio opzionale.

Dining table with 12 legs in transparent handmade Murano glass. Also available in fine-gold or in special colours on request. Plinth in smoked mirror glass. Top in 15mm thick extraclear glass with 45° bevel and with Diamante engravings. Lazy Susan with Diamante engravings and central section in mirror finish as option.





FLAMBE' 72

Disegno Riccardo Lucatello

Tavolo a 2 basamenti ciascuno a 9 elementi in vetro di Murano trasparente. Disponibile anche in oro zecchino o in altri colori speciali a richiesta. Zoccolo in vetro specchio fumé. Piano ellittico in cristallo extrachiario spessore 15mm con bisello 45°.

Dining table with 2 bases each with 9 legs in transparent handmade Murano glass. Also available in fine gold or in special colours on request. Plinth in smoked mirror glass. Oval top in 15mm thick extra clear glass with 45° bevel.



TAVOLI / DINING TABLES

CORALLO 72

Disegno Tulzinsky

Tavolo da pranzo con piano in vetro extra-chiaro e basamento in vetro di Murano lavorato a mano nei colori trasparente o oro. Zoccolo in finitura cromo. Opzionale impianto luce nello zoccolo.

Dining table with extra clear glass top and base in handmade Murano glass, transparent or gold finish. Plinth in chromed finish. Optional LED lighting in the plinth.







gambe • legs

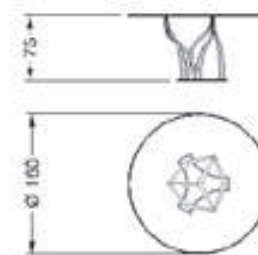
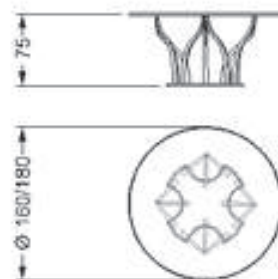

piano • top

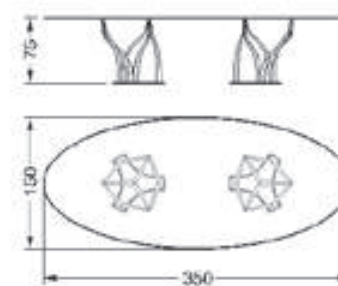
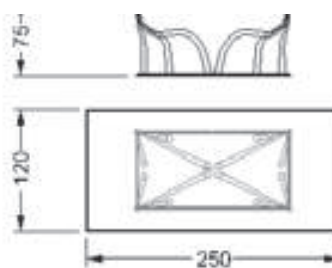

Piano • Top



Base • Base

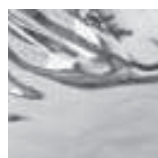

Gambe Murano • Murano Legs

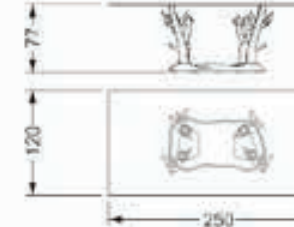
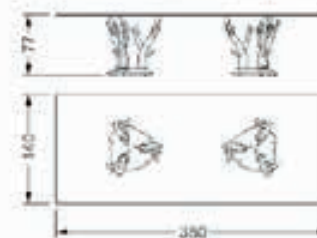
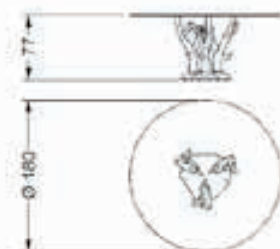
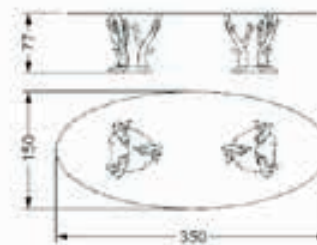
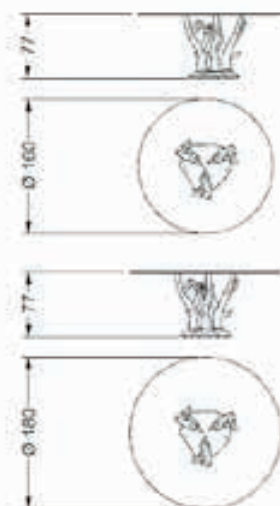
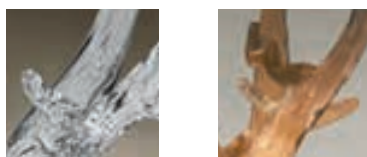

TAVOLI / DINING TABLES

NAUTILUS 72 SPECIAL

Disegno Reflex

Tavolo pranzo con base composta da cilindri in vetro di Murano nelle finiture Oro, Murrine e Striato. Versione speciale con top tondo in vetro. Perimetro e zoccolo in Ebano lucido.

Dining table with base made up of cylinders in Murano glass in the finishes: Gold, Murrine and Striato. Special round top in glass with perimeter band and plinth in shiny Ebony wood.



TAVOLI / DINING TABLES

NAUTILUS 72 SPECIAL

Disegno Reflex

Tavolo pranzo con base composta da cilindri in vetro di Murano, disponibili nelle finiture Oro, Murrine e Striato. Piano in vetro extrachiaro stratificato con fascia perimetrale e zoccolo in Ebano lucido. Optional: illuminazione a LED nello zoccolo, con possibilità di batteria ricaricabile.

Dining table with base made up of cylinders in handmade Murano glass, available in Gold, Murrine and Striato finish. Extra clear laminated glass top with perimeter band and plinth in shiny Ebony wood. Optional: LED lighting system in the base, available also with chargeable battery.







base e piano • base and top



gambe • legs



SCHEDA TECNICA • TECHNICAL DRAWINGS

Special

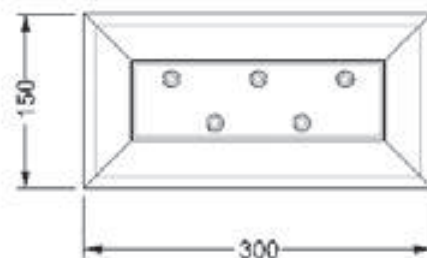
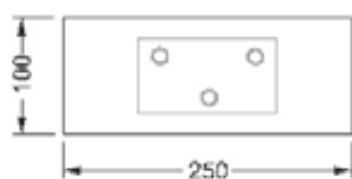

Special

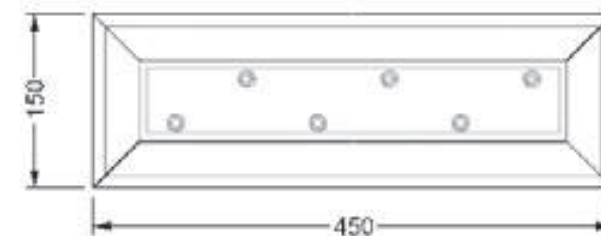

SASSI 72 SPECIAL

Disegno Reflex

Tavolo pranzo con base composta da gambe in vetro di Murano finitura Calcedonio o ambra e zoccolo in Ebano lucido o in legno laccato lucido. Piano in vetro extrachiaro con fascia perimetrale in Ebano lucido o in legno laccato lucido spessore 40mm. Opzionale: illuminazione a LED con possibilità e batteria ricaricabile. Finiture speciali per le gambe disponibili su richiesta.

Dining table with base made up of Murano glass legs in Calcedonio or in amber finish. Plinth in shiny Ebony or shiny lacquered wood. Top in extra clear glass with perimeter band in shiny Ebony or shiny lacquered wood 40mm thick. Optional: LED lighting and rechargeable battery. Special finishes for the legs available on request.





SASSI 72

Disegno Reflex

Tavolo pranzo con base composta da gambe in vetro di Murano finitura Calcedonio o ambra e zoccolo in legno laccato lucido o in Ebano lucido. Piano in vetro extrachiaro spessore 15mm con angoli arrotondati R13cm e bisello 30°. Optional illuminazione a LED con possibilità di batteria ricaricabile.

Dining table with base made up of Murano glass legs in Calcedonio or in amber finish and plinth in shiny Ebony or shiny lacquered wood. Top in 15mm thick extra clear glass with rounded corners R13cm and 30° bevel. Optional LED lighting in the base with possibility of rechargeable battery.



base e piano • base and top



gambe • legs



SCHEDA TECNICA • TECHNICAL DRAWINGS

special

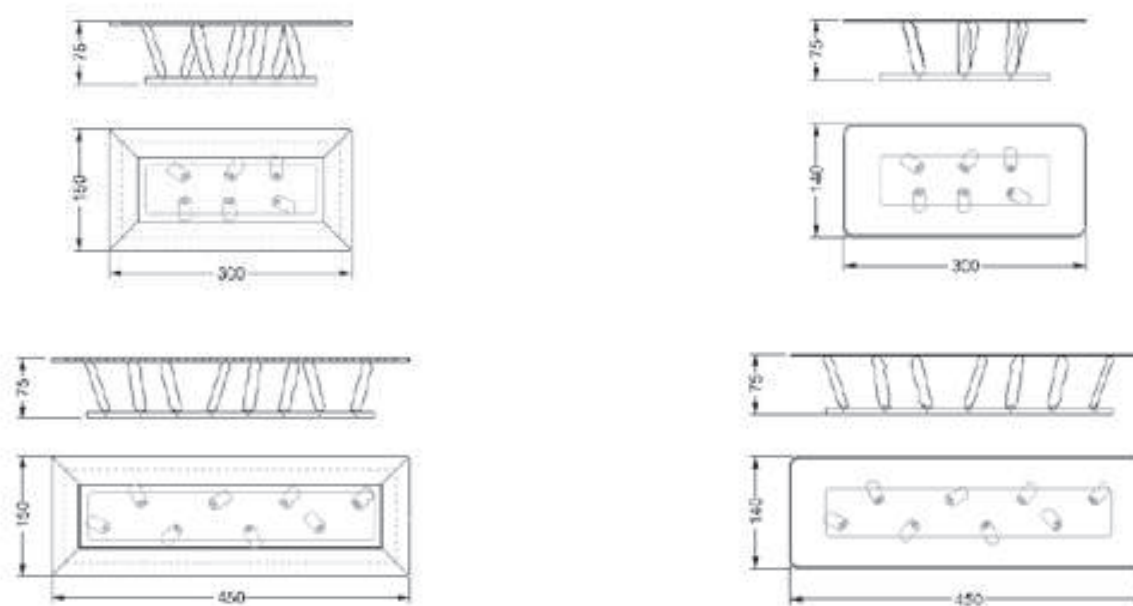

TAVOLI / DINING TABLES

BELLE EPOQUE 72

Disegno Studio Viganò

Tavolo da pranzo con piano in legno sp. 40mm, disponibile in versione laccata lucida con gambe in legno laccato lucido (composizioni predefinite) e decori in tinta, oppure con piano e gambe in legno Ebano lucido con decori in acciaio satinato. Lame in metallo finitura oro satinato

Dining table with wooden top 40mm thick, available in shiny lacquered finish with shiny lacquered legs (fixed composition) and decoration in the same colour of the top, or with top and legs in shiny Ebony wood with decoration in glazed steel. Metal details in glazed gold finish.





Piano e gambe • Top and legs

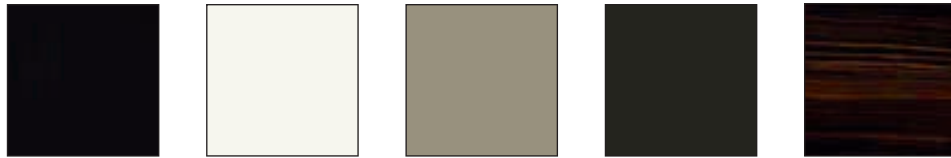

dettagli • details



SCHEDA TECNICA • TECHNICAL DRAWINGS

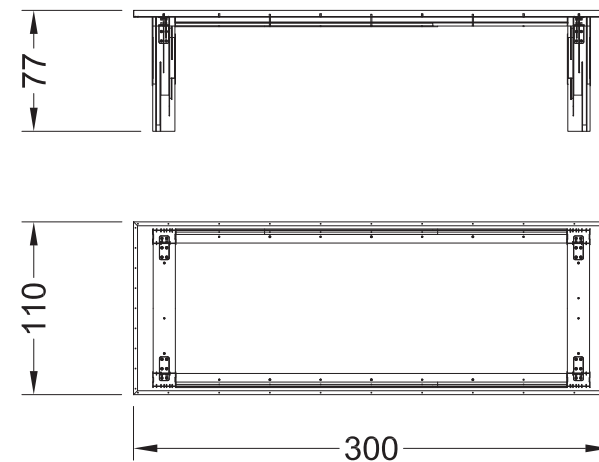

TAVOLI / DINING TABLES

FILI D'ERBA 72

Disegno Tulczinsky



TAVOLI / DINING TABLES

FILI D'ERBA 72

Disegno Tulczinsky

Tavolo pranzo con base in vetro di Murano in blu, turchese e bianco sabbato oppure nelle finiture Rugiada, Calcedonio oppure oro e Murrine.
Piano in vetro spessore 15 mm.

Dining table with Murano glass base in the combination of blue, turquoise and white frosted or in the special finishing Rugiada, Calcedonio or gold and Murrine.
Top in transparent glass top 15 mm thick.





gambe • legs



legno • wood

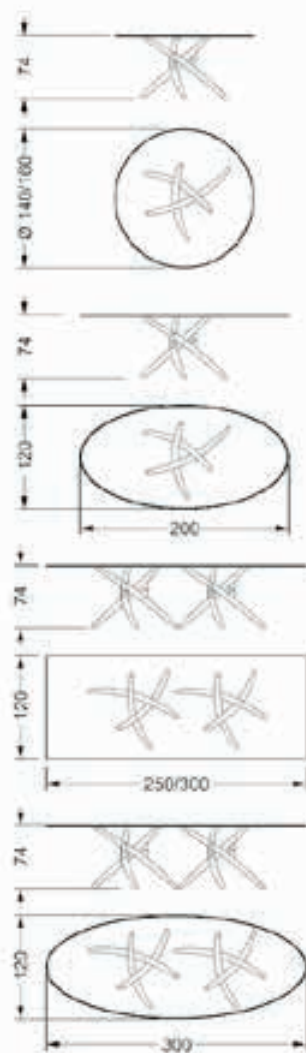

vetro • glass

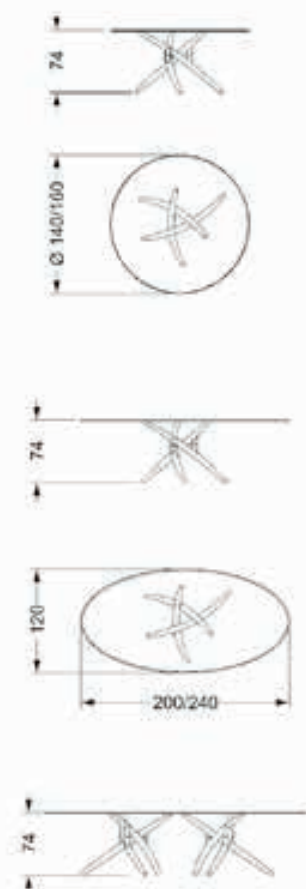
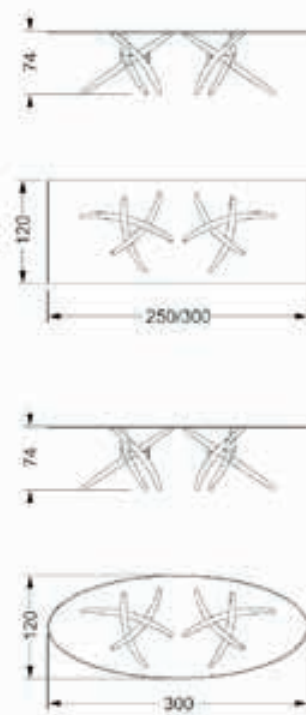

TAVOLI / DINING TABLES

ARLEQUIN 72

Disegno Maurice Barilone

Tavolo con basamento in vetro di Murano disponibile in diversi colori con finitura liscia lucida o sabbiata o rigata lucida. Piano in cristallo spessore 12 o 15mm con bisello 45°.

Dining table with Murano glass base available in different colours with shiny smooth or sandblasted smooth finish or with shiny ribbed finish. Glass top 12 or 15mm thick with 45° bevel.





anello • ring



bastone rigato • ribbed leg



bastone liscio • smooth leg



SCHEDA TECNICA • TECHNICAL DRAWINGS

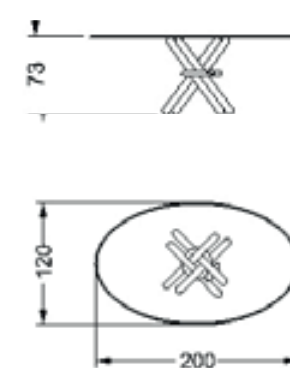
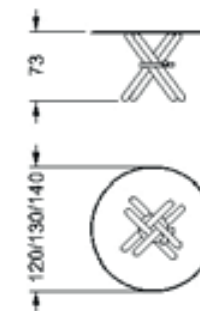
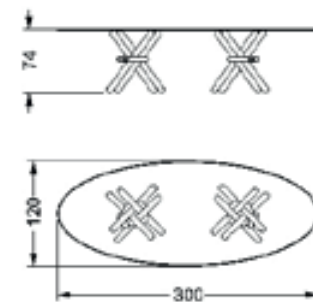
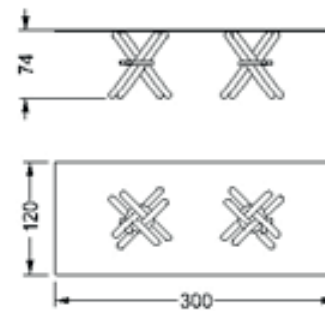

TAVOLI / DINING TABLES

TORSADES 72

Disegno Maurice Barilone

Tavolo con basamento in vetro di Murano
disponibile in vari colori in finitura liscia o
rigata. Piano in vetro trasparente.

Dining table with base in Murano glass,
available in various colours in smooth or
ribbed finish. Top in transparent glass.



gamba liscia • smooth legs



gamba rigata • ribbed legs

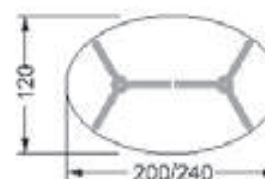

TAVOLI / DINING TABLES

BOLSHÓJ 72

Disegno Tulczinsky

Tavolo pranzo con basamento in vetro di Murano lavorato a mano disponibile in diversi colori con finitura sabbata o rigata. Supporti con lavorazione a foglia oro o argento. Piano in cristallo sp. 15 mm con finitura OG.

Dining table with handmade Murano glass base available in different colours with sandblasted or ribbed finish. Plinth in gold or silver leaf finish. Glass top 15 mm thick with OG bevel.



base • base



gamba rigata • ribbed leg



gamba liscia • smooth leg

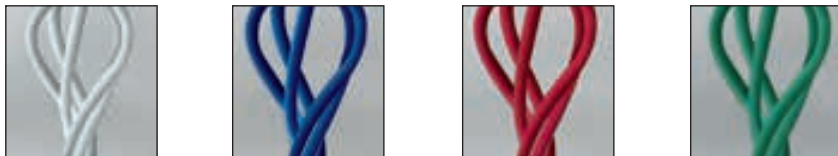

SCHEDA TECNICA • TECHNICAL DRAWINGS

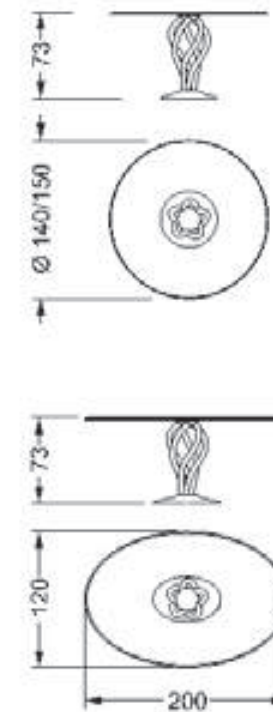

TAVOLI / DINING TABLES

NEOLITICO 72

Disegno Tulczinsky

Tavolo pranzo con basamento in ferro battuto finitura foglia oro o argento oppure ottone o titanium. Piano in vetro spessore 15mm con bisello 45°.

Dining table with base in forged iron in gold or silver leaf or in brass or titanium finish. Glass top 15mm thick with 45° bevel





NEOLITICO 72 VETRO

Disegno Tulczinsky

Tavolo pranzo con base in vetro curvato spessore 24mm trasparente o verniciato nero oppure in vetro extrachiario spessore 19mm trasparente. Piano in cristallo spessore 15mm con bisello 45°.

Dining table with base in curved glass 24mm thick, transparent or black lacquered or in extra clear transparent glass 19mm thick. Glass top 15mm thick with 45° bevel.





base vetro • glass base

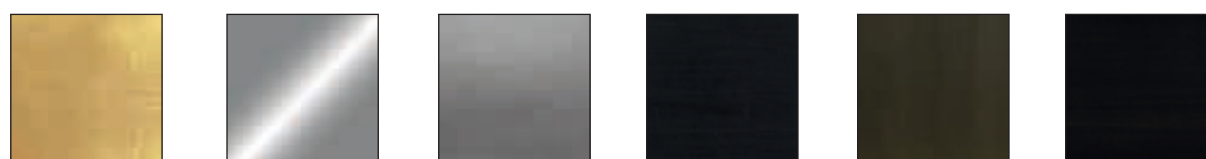

SCHEDA TECNICA • TECHNICAL DRAWINGS

ferro • iron

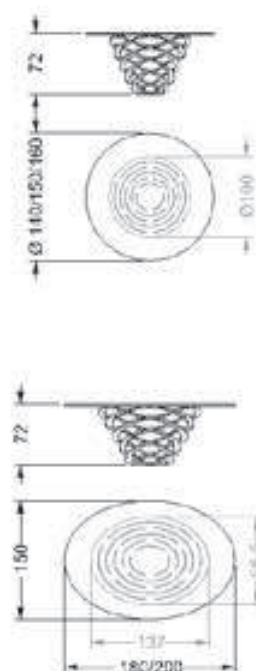

vetro • glass

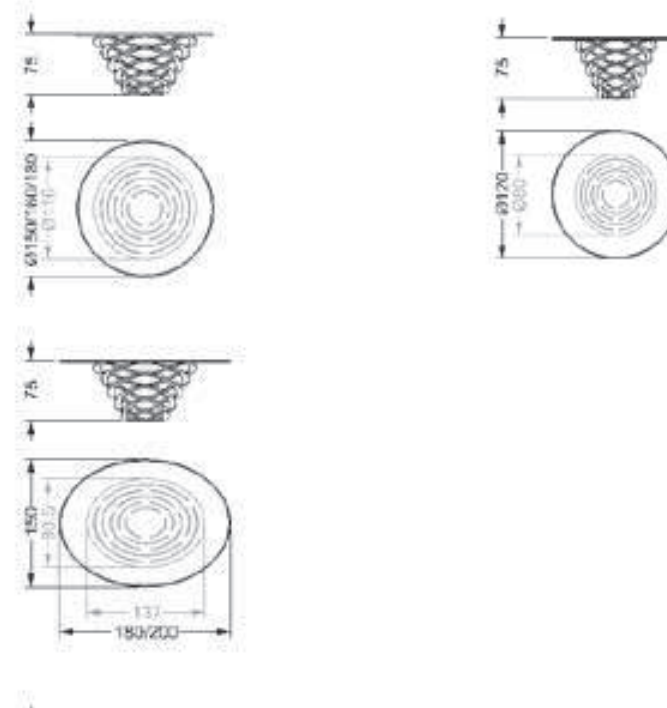

TAVOLI / DINING TABLES

GRAN CANAL 72

Disegno Riccardo Lucatello

Tavolo pranzo con base in vetro di Murano trasparente liscio o rigato o in vari colori. Piano in cristallo o in cristallo extrachiaro spessore 15mm.

Dining table with legs in glossy or ribbed transparent Murano glass or in various colours. Top in 15mm thick glass or in extra clear glass.

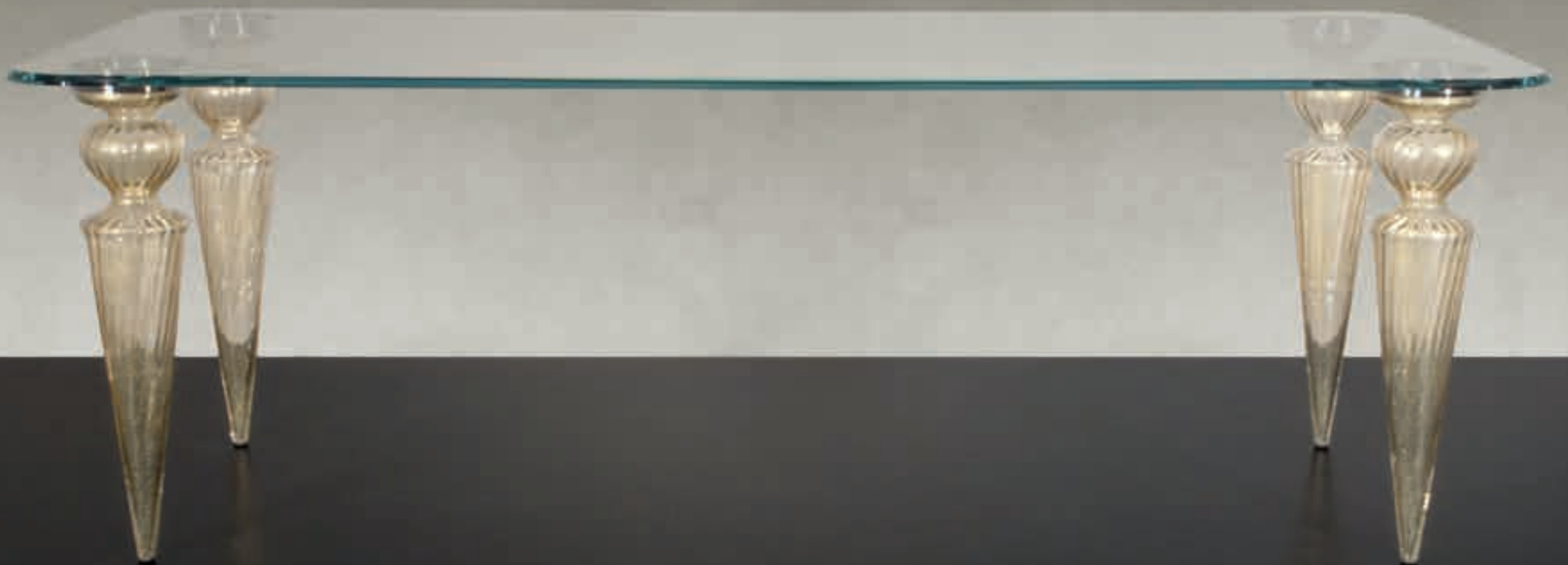

GRAN CANAL 72 LEGNO

Disegno Riccardo Lucatello

Tavolo pranzo con base in vetro di Murano trasparente liscio o rigato o in vari colori. Piano in legno spessore 40mm con bordo sagomato nelle finiture laccato opaco, laccato lucido, Noce Canaletto, tinto wengé, Ebano lucido o opaco.

Dining table with legs in glossy or ribbed transparent Murano glass or in various colours. Top in 40mm thick wood with rounded edge in the finishes: matt or shiny lacquered, Canaletto walnut, wengé, shiny or matt Ebony wood.





piano • top



gambe • legs



gold special

legno • wood

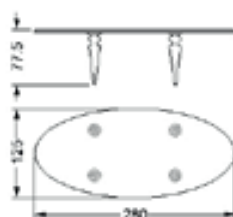
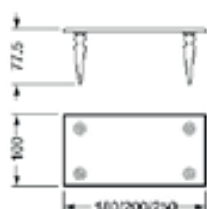

vetro • glass

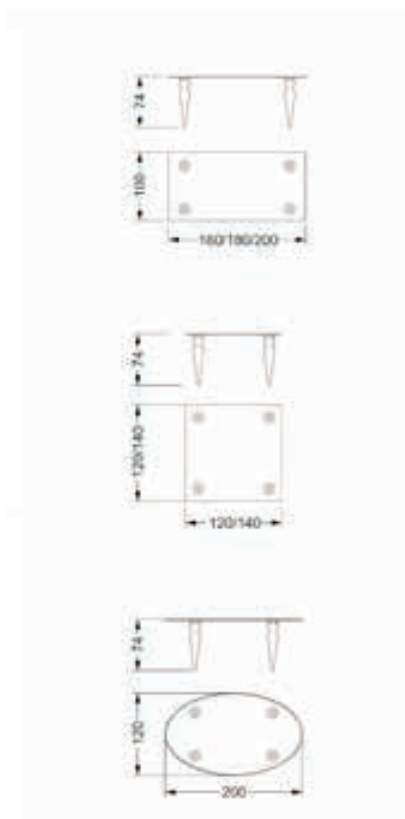
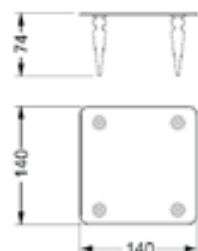
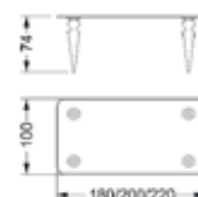
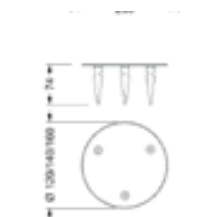

TAVOLI / DINING TABLES

BAMBOO 72

Disegno Tulczinsky

Tavolo pranzo con basamento composto da bastoni in vetro di Murano con filigrana nera e zoccolo in specchio fumé. Piano in vetro extrachiario trasparente oppure in Bevel Wood sp. 40mm.

Dining table with base composed by Murano glass tubes with black filigree and plinth in smoked mirror glass. Top in transparent extra clear glass or in 40 mm thick Bevel Wood.



BAMBOO 72 BEVEL WOOD

Disegno Tulczinsky

Tavolo pranzo con basamento composto da bastoni in vetro di Murano con filigrana nera e zoccolo in vetro specchio fumé. Piano in legno spessore 40mm con bordo rastremato 45° (Bevel Wood) nelle finiture Rovere Henné, laccato opaco rivestito in vetro verniciato o acidato verniciato o in Ebanolucido o opaco.

Dining table with base composed by transparent Murano glass legs with black filigree and plinth in smoked mirror glass. Wooden top 40mm thock with tapered edges 45° (Bevel Wood) available in Henné Oakwood, matt lacquered wood with upper top in shiny or etched lacquered glass or in shiny or matt Ebony wood.







TAVOLI / DINING TABLES

IMPACT 72

Disegno Tulczinsky

Tavolo con basamento in ferro naturale spazzolato e verniciato. Sfera in vetro di Murano lavorato a mano nei colori blu, verde o rosso. Piano in cristallo temperato, sp. 19 mm filo lucido.

Dining table with base in varnished forged iron. Murano glass sphere available in blue, green or red. Top in tempered glass 19 mm thick with polished edges.





piano • top

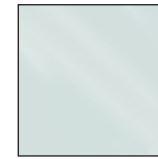
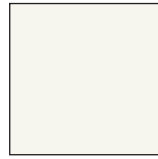

gambe • legs



bevel wood

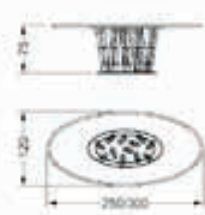
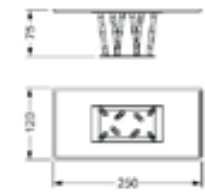
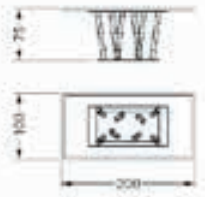

vetro • glass

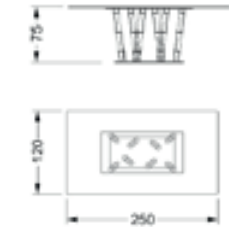
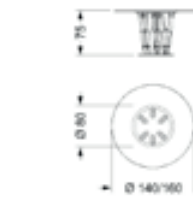
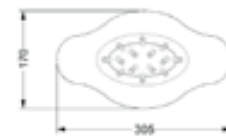
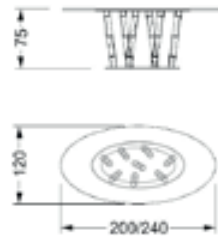

base • base

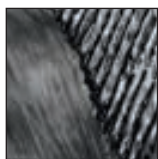

sfera • sphere

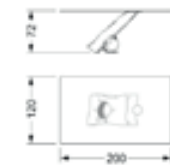
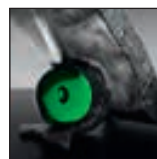
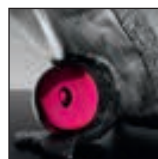
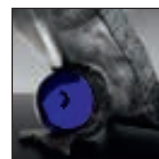

TAVOLI / DINING TABLES

TRANSEO 72 CRAQUELE'

Disegno Tulczinsky

Tavolo con base composta da 4 o 3 gambe in cristallo extrachiario craquelé con particolari in metallo cromato. Piano in cristallo spessore 15 mm.

Dining table with base composed by 3 or 4 legs in extra clear craquelé transparent glass with details in shiny chromed metal. Glass top 15 mm thick with polished edges.



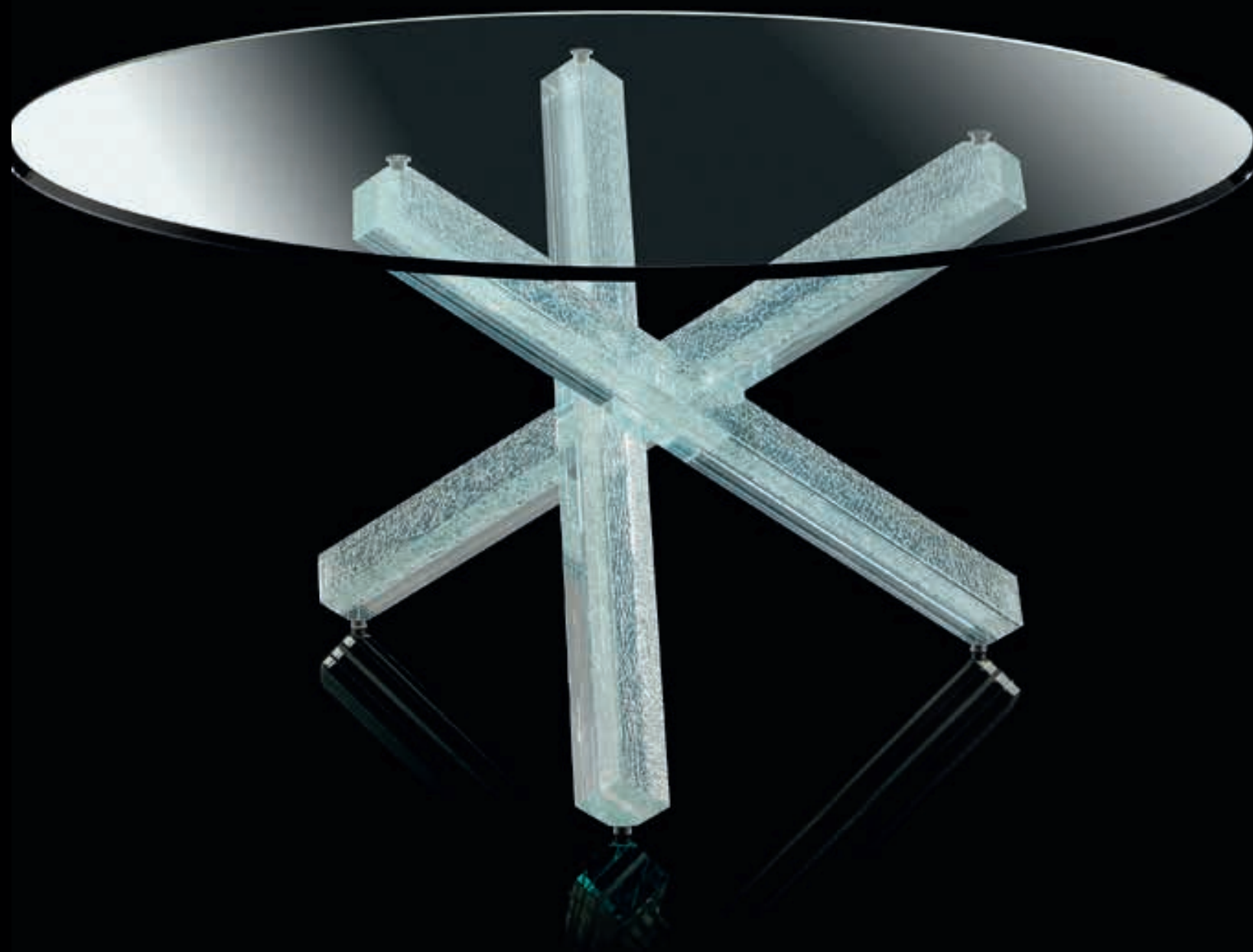

TAVOLI / DINING TABLES

INFINITO

VETRO MARMO

Disegno Riccardo Lucatello

Tavolo con base in acciaio inox satinato o in ottone antico scuro. Piano in vetro marmo stampato.

Table with base in brushed steel or in antiqued dark brass. Top in glass, printed marble.



TRANSEO 72 CRAQUELE'

FINITURE • FINISHES

SCHEDA TECNICA • TECHNICAL DRAWINGS

gambe • legs

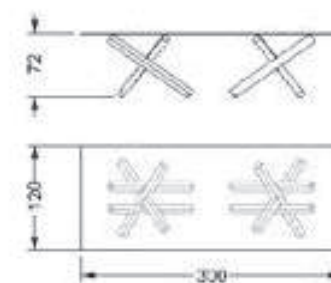
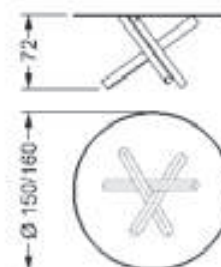
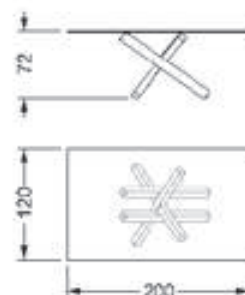

INFINITO 72 VETRO MARMO

FINITURE • FINISHES

SCHEDA TECNICA • TECHNICAL DRAWINGS

piano • top

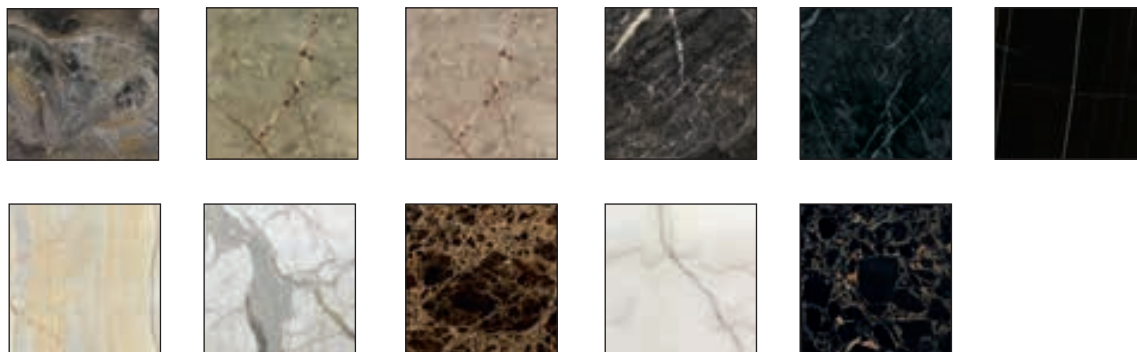

gamba • legs

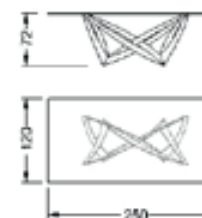
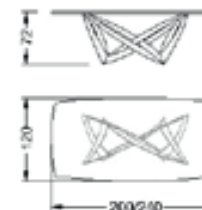

TAVOLI / DINING TABLES

ANDROMEDA 72

Disegno Reflex

Tavolo con base in materiale granitico scolpito e bocciardato a mano. Piano in cristallo sp. 15 mm con bisello 45°.

Dining table with base in carved granitic material, with bush-hammered finish. glass top 15 mm thick with 45° bevel.



TAVOLI / DINING TABLES

CA' D'ORO 72

Disegno Reflex

Tavolo con gambe in vetro di Murano finitura Cappuccino. Base in vetro specchio fumé. Piano in cristallo spessore 15mm.

Dining table with legs in Murano glass Cappuccino finish. Plinth in smoked mirror glass. Glass top 15 mm thick.



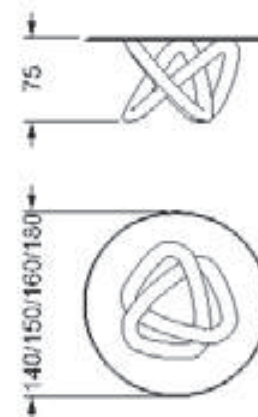

gambe • legs

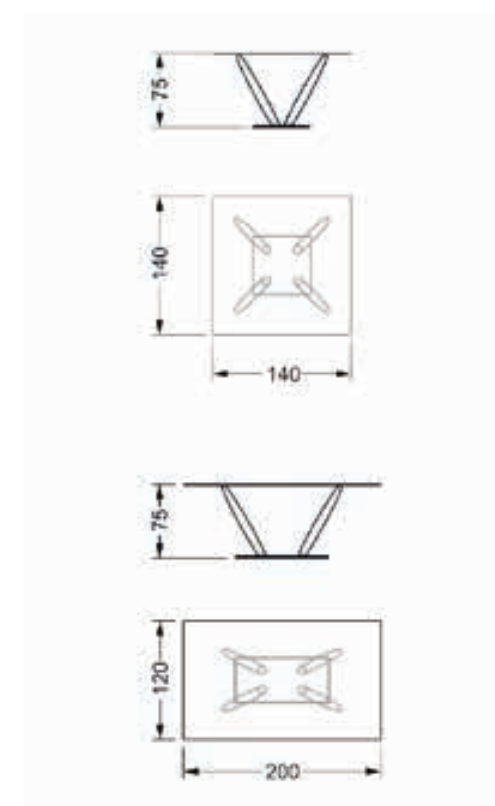
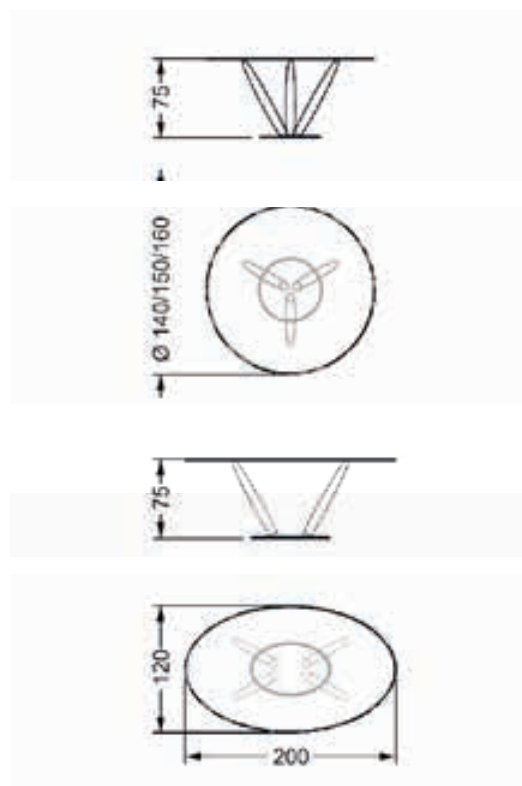

LEISURE

BILL

Disegno Reflex

Tavolo da biliardo con piano in vetro acidato con trattamento resistente al graffio oppure rivestito in panno. Struttura in legno laccato lucido e gambe in vetro di Murano trasparente o colorato. Opzionale: illuminazione per top e gambe a LED.

Billiard table with top in etched glass with scratch-resistant treatment or covered in playing-felt. Shiny lacquered wooden structure and Murano glass legs in transparent or coloured finish. Optional: LED lighting system for top and legs.



piano • top



Panno • Playing felt

struttura • structure



gamba • leg

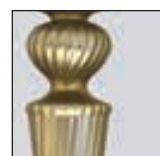
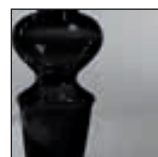

gold special

SCHEDA TECNICA • TECHNICAL DRAWINGS

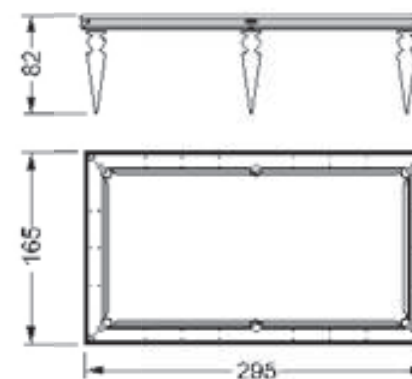

LEISURE

SCACCHI

Disegno Riccardo Lucatello

Tavolo da gioco con gambe in vetro di Murano trasparente liscio o rigato oppure colorato. Struttura in legno laccato opaco nero o latte con 2 cassetti. Piano in cristallo con bisello 45° verniciato nero o latte con scacchiera nero/beige. Optional: set di scacchi in vetro di Murano nero e trasparente (edizione limitata 100 copie).

Play-table with transparent or coloured Murano glass legs. Wooden structure in black or latte matt lacquered finish with 2 drawers. Glass top with 45° bevel lacquered in black or latte colour with chessboard in black/beige. Optional: set of chess pieces in black and transparent Murano glass (limited edition 100 sets)





piano • top

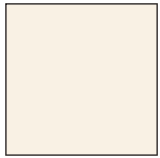

gamba • leg

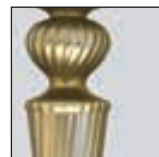
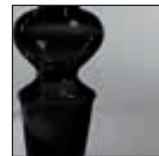
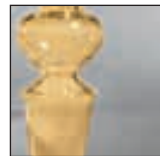

gold special

SCHEDA TECNICA • TECHNICAL DRAWINGS

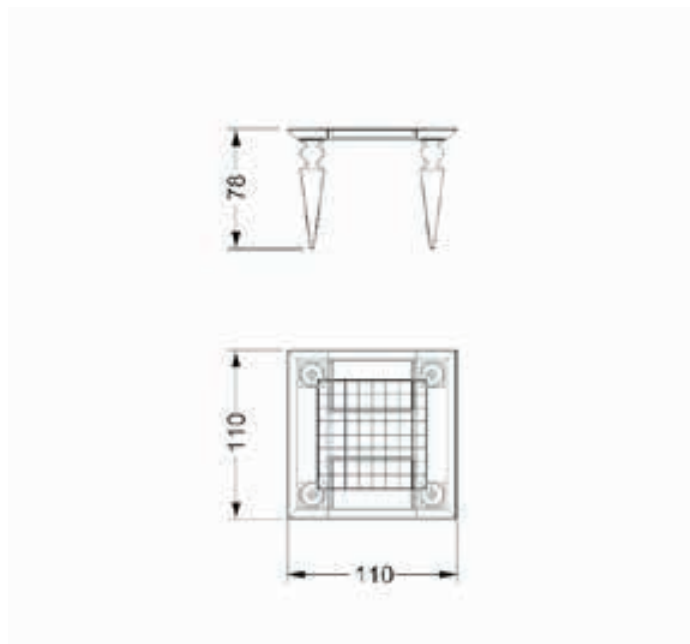

LEISURE

POKER

Disegno Reflex

Tavolo da gioco con gambe in vetro di Murano trasparente liscio o rigato oppure colorato. Struttura in legno laccato opaco. Piano in cristallo verniciato in tinta con la struttura con meccanismo pivotante per cambio lato. Parte centrale rivestita in panno da gioco o in pelle. Lazy Susan integrato opzionale.

Play-table with legs in transparent or coloured Murano legs. Structure in matt laquered wood with revolving mechanism to change the playing top. Central section covered in playing felt or in leather. Built-in Lazy Susan as optional.



piano vetro/legno • glass/wood top

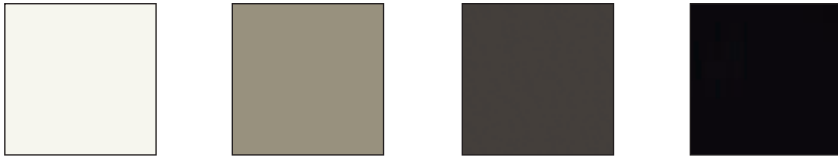

piano centrale • central top



Panno • Playing felt
Pelle • Leather

gamba • leg

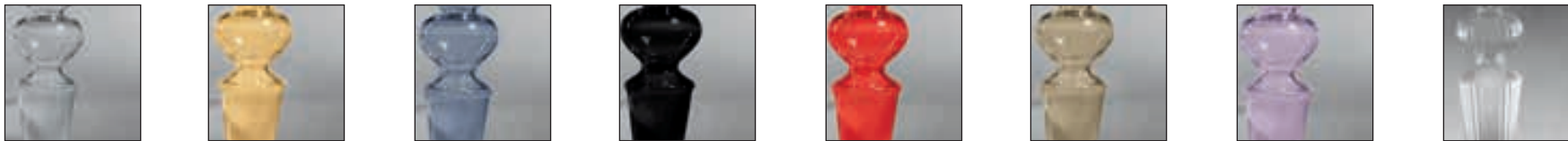

gold special

SCHEDA TECNICA • TECHNICAL DRAWINGS

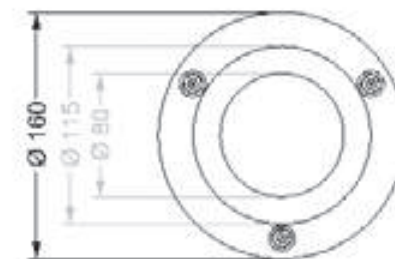
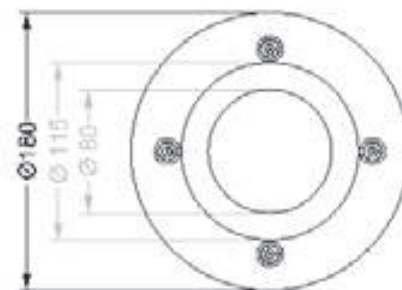

TAVOLI / DINING TABLES

PARENTESIS 72

Disegno Tulkzinsky

Tavolo pranzo con basi in finitura ottone antico scuro e zoccolo in vetro specchio fumè. Piano in vetro trasparente o extrachiaro spessore 15 mm oppure in vetro-Marmo.

Dining table with bases in antiqued dark brass finish and plinth in smoked mirror glass. Top in 15 mm thick transparent glass or extraglass or in Marble-glass.





TAVOLI / DINING TABLES

SIGNORE DEGLI ANELLI 72 STEEL

Disegno Tulkzinsky

Tavolo pranzo con basi a cilindri in finitura ottone antico scuro. Piano in legno finitura ottone antico scuro con inserto in vetro verniciato o acidato verniciato oppure in vetro-Marmo.

Dining table with base composed by cylinders in antiqued dark brass finish. Wooden top in antiqued dark brass finish with inlay in lacquered or etched lacquered glass or in Marble-glass.





GALASSIA 72

Disegno Tulkzinsky

Tavolo pranzo con basamento e zoccolo in legno finitura ottone antico scuro con dettagli in acciaio lucido. Piano in legno con bordo in ottone antico scuro e inserto in vetro verniciato o acidato verniciato nei colori latte, nero beluga, fumo, henné o in vetro marmo.

Dining table with base and plinth in antiqued dark brass finish with details in shiny steel. Wooden top with edge in antiqued dark brass finish with insert in lacquered or etched lacquered glass in latte, nero beluga, fumo or henné colour or in marble glass.





Piano • Top



Base • Base

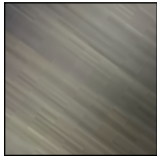

Zoccolo • Plinth

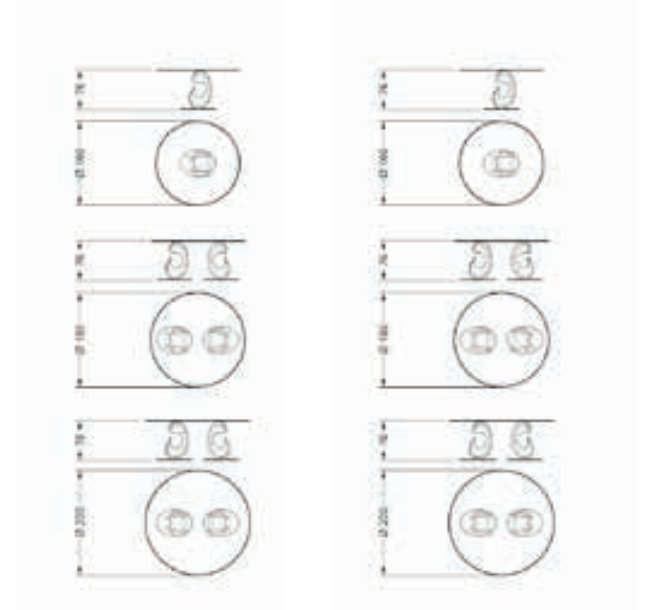

Piano • Top

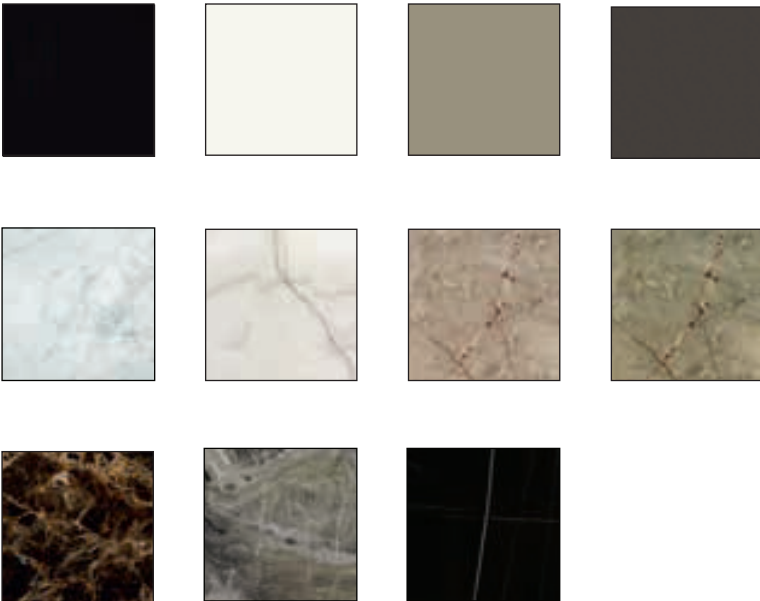

Base • Base

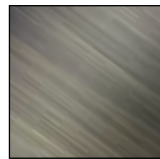

Galassia 72

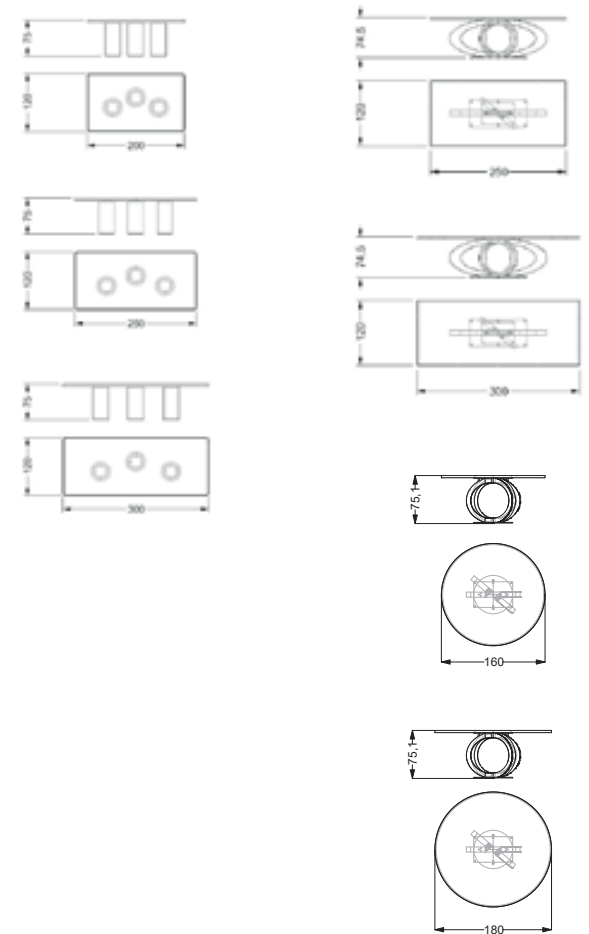
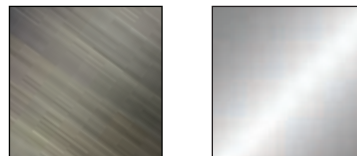

SEDE DIVANI

CHAIRS SOFAS

180	<i>AVANTGARDE sofa</i>
159	<i>BASTIDE collection</i>
184	<i>BELLE EPOQUE Sofa</i>
176	<i>CA' D'ORO collection</i>
168	<i>CASANOVA collection</i>
155	<i>NEW YORK XL</i>
156	<i>NEW YORK 2</i>
191	<i>NUVOLA SOFA e POLTRONA</i>
152	<i>PEGGY</i>
150	<i>PEGGY ALTA</i>
151	<i>PEGGY ALTA MURANO</i>
166	<i>PERSHING</i>
164	<i>PETALO</i>
154	<i>SWAN</i>
189	<i>SWAN SOFA E POLTRONA</i>
163	<i>VENEZIA</i>

SEDUTE E DIVANI / CHAIRS AND SOFAS

PEGGY ALTA

Disegno Reflex



PEGGY ALTA MURANO

Disegno Reflex

Poltroncina con struttura in legno, rivestita in pelle o velluto. Gambe in legno laccato nero beluga lucido o opaco, in tinta wengè, oppure in noce Canaletto. Trapuntatura Diamond opzionale su seduta, schienale e retro-schienale. Disponibile anche nella versione con gambe anteriori in vetro di Murano polvere oro.

Armchair with wooden structure, covered in velvet or leather. Legs in Nero Beluga matt or shiny lacquered, wengè finish, or in canaletto walnut finish. Diamond quilting on the seat, on the back and reverse-back, as option. Available also with the frontal legs in Murano glass with gold powder.



PEGGY

Disegno Diana Zabarella

Poltroncina con struttura in legno imbottita e rivestita in pelle o in velluto. Gambe in legno finitura laccato nero opaco o lucido, tinta wengé o Noce Canaletto. Possibilità di trapuntatura Diamond su seduta, schienale e retro schienale.

Armchair with wooden structure padded and upholstered in leather or in velvet. Legs available in matt or shiny black lacquered, wengé or Canaletto walnut finish. Seat, back and reverse back available with Diamond quilting.



trapuntatura • quilting

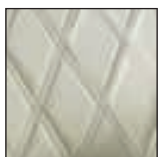

rivestimento • upholstery

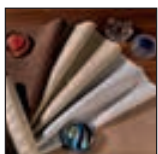

Velluto - velvet
 Pelle C
 Pelle Nabuk
 Pelle colorata
 Pelle Dune

gamba • leg



SCHEDA TECNICA • TECHNICAL DRAWINGS

peggy

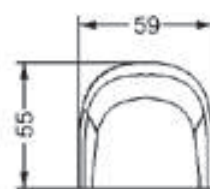
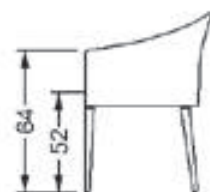

peggy alta

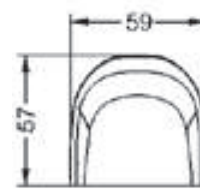
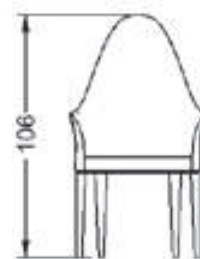
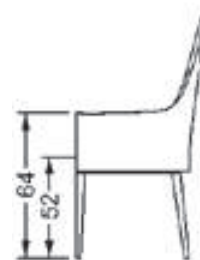

peggy murano

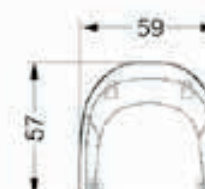
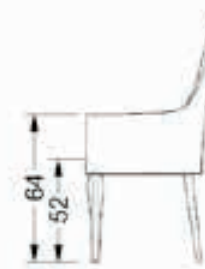

SWAN

Disegno Tulczinsky

Sedia con struttura in legno dotata di ruote. Rivestimento in pelle o velluto con trapuntatura San Marco su seduta e schienale interno. Piastra girevole magnetica e braccioli opzionali.

Chair with wooden structure equipped with wheels. Covered in leather or in velvet with San Marco quilting on seat and internal back. Magnetic turning base and arms as option.



NEW YORK XL

Disegno Reflex

Sedia con struttura in legno disponibile in laccato lucido nero beluga, Ebano lucido o Noce Canaletto.

Rivestimento in pelle o in velluto con possibilità di trapuntatura Diamond o San Marco.

Chair with wooden structure available in shiny beluga black lacquered, shiny Ebony wood or Canaletto walnut. Upholstered in leather or in velvet with optional Diamond or San Marco quilting.



NEW YORK 2

Disegno Sacha Lakic

Sedia con struttura in legno disponibile in laccato lucido nero beluga, Ebano lucido o Noce Canaletto.

Rivestimento in pelle o in velluto con possibilità di trapuntatura Diamond o San Marco.

Chair with wooden structure available in shiny beluga black lacquered, shiny Ebony wood or Canaletto walnut. Upholstered in leather or in velvet with optional Diamond or San Marco quilting.





trapuntatura • quilting



rivestimento • upholstery



Velluto - velvet
 Pelle C
 Pelle Nabuk
 Pelle colorata

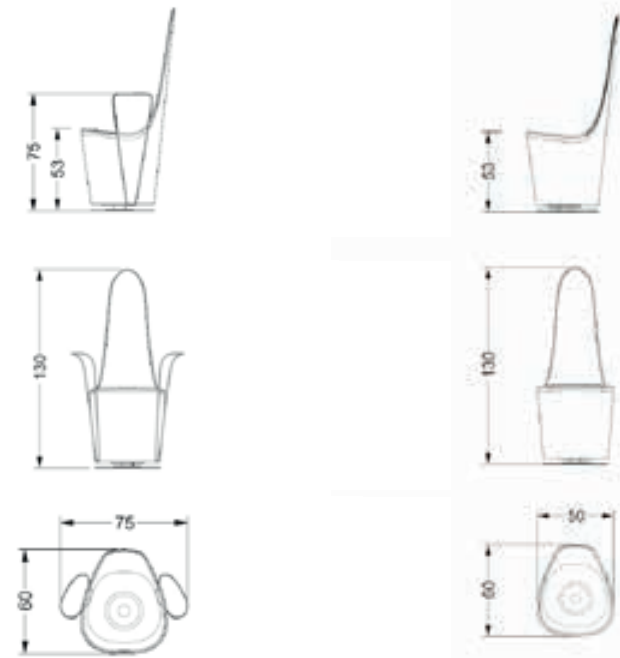

trapuntatura • quilting



rivestimento • upholstery

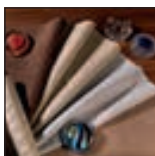

Velluto - velvet
 Pelle C
 Pelle Nabuk
 Pelle colorata

struttura • structure



New York 2

New York XL

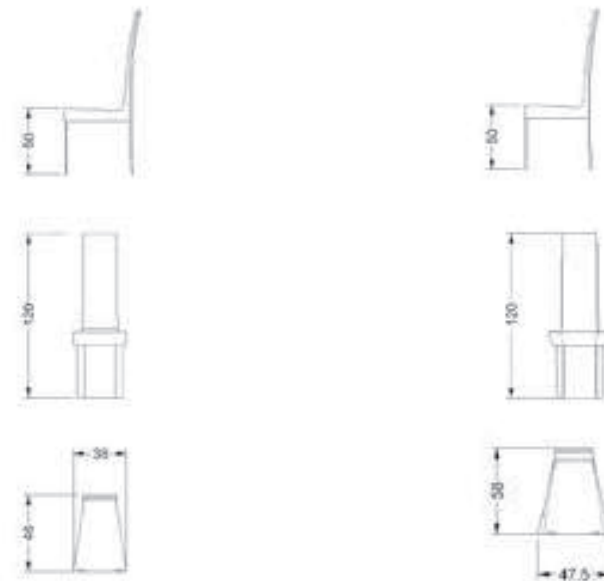

BASTIDE COLLECTION

Disegno Andree Putman

Sedia, poltroncina e sgabello con struttura in legno laccato lucido nero beluga, bianco, latte o fumo. Rivestimento in tessuto, velluto o pelle.

Chair, armchair and barstool with wooden structure in shiny lacquered wood, colours black, white, latte or fumo. Upholstery in fabric, velvet or leather.







rivestimento • upholstery

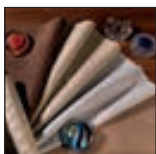

Velluto - velvet
 Pelle C
 Pelle Nabuk
 Pelle colorata
 Pelle Dune

struttura • structure



SCHEMA TECNICA • TECHNICAL DRAWINGS

sgabello • tabouret

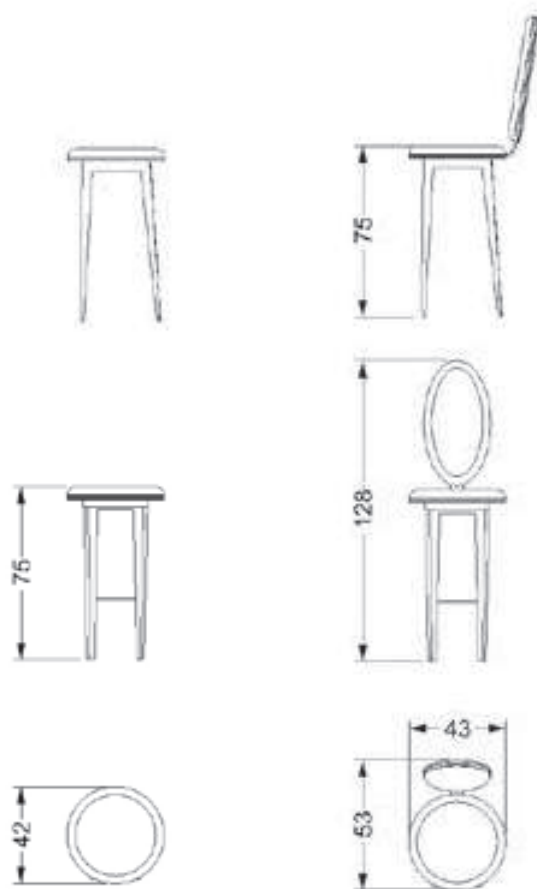

poltroncina • armchair



sedia • chair



VENEZIA

Disegno Reflex

Sedia con schienale curvato rivestita in pelle o velluto. Disponibile con gambe in legno laccato nero lucido oppure con gambe in metallo finitura cromo lucido.

Chair with curved back covered in leather or velvet. Available with black shiny lacquered wooden legs or with shiny chromed metal legs.



PETALO

Disegno Tulczinsky

Poltroncina dalla caratteristica forma a petalo disponibile con o senza braccioli. Base in fusione di alluminio finitura ottone o titanium, con possibilità di inserire ruote a scomparsa. Rivestimento in pelle o tessuto.

Chair in petal shape available with or without arms. Base in aluminium fusion in brass or titanium finish also with foldaway wheels. Upholstery in leather or fabric



rivestimento • upholstery

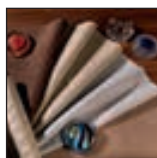

Velluto - velvet
 Pelle C
 Pelle Nabuk
 Pelle colorata

struttura • structure



rivestimento • upholstery

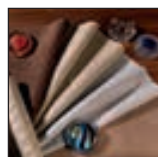

Tessuto - fabric
 Pelle C
 Pelle Nabuk
 Pelle colorata
 Pelle Dune

base • base



poltroncina • armchair



sedia • chair



SEDUTE E DIVANI / CHAIRS AND SOFAS

PERSHING

Disegno Andree Putman

Poltroncina con struttura in legno laccato opaco nero o in tinta pelle. Rivestimento in tessuto, pelle o velluto.

Chair with wooden structure in black matt lacquered finish or matt lacquered same colour as leather. Upholstery in fabric, leather or velvet.



rivestimento • upholstery



Velluto - velvet
 Pelle C
 Pelle Nabuk
 Pelle colorata
 Pelle Dune

struttura • structure



SCHEDA TECNICA • TECHNICAL DRAWINGS

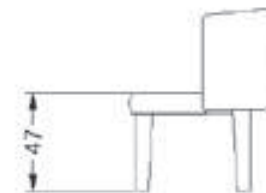

CASANOVA COLLECTION

Disegno Marco Cocco

Collezione composta da divano, poltrona, bergere e triclinio con rivestimento in pelle. Cuscino imbottito disponibile in pelle o velluto, liscio o con trapuntatura San Marco. Gambe in vetro di Murano trasparente, con polvere oro o in tinta pelle.

Collection of sofa, armchair, bergere and triclinium upholstered in leather. Padded seat-cushions available in leather or in velvet, plain or with San Marco quilting. Legs in transparent Murano glass or in gold powder or in same colour as the leather.





SEDUTE E DIVANI / CHAIRS AND SOFAS

CASANOVA COLLECTION

Disegno Marco Cocco





SEDUTE E DIVANI / CHAIRS AND SOFAS

CASANOVA COLLECTION

Disegno Marco Cocco





rivestimento struttura • structure upholstery

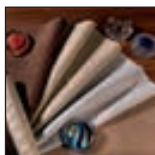

Pelle C
Pelle colorata
Pelle Dune

rivestimento seduta • seat upholstery



Velluto - velvet
Pelle C
Pelle Nabuk
Pelle colorata
Pelle Dune

trapuntatura seduta • seat quilting



gambe di serie • standard legs



gambe speciali • special legs

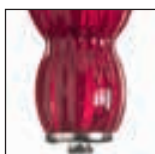

poltrona • armchair



divano • sofa

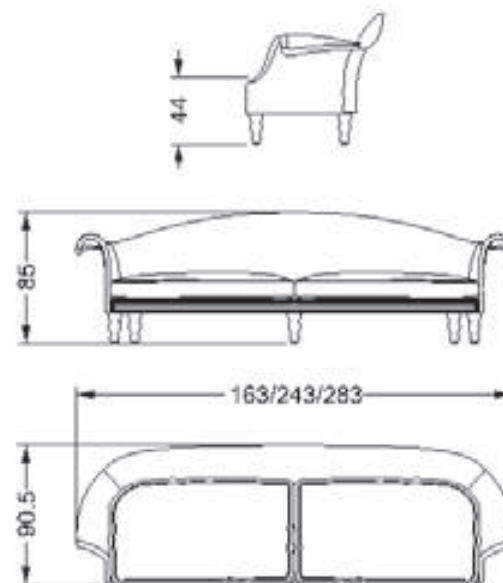

bergère • bergère



triclinio • triclinium

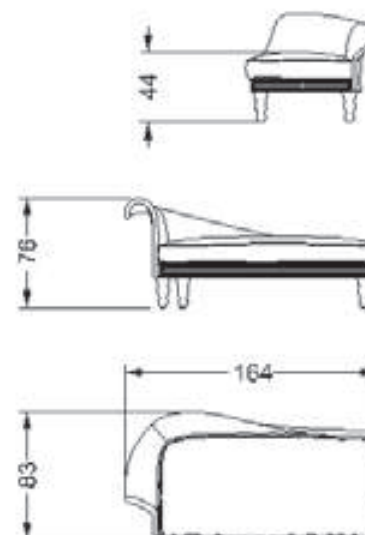

CA' D'ORO COLLECTION

Collezione composta da divano e poltrona con cuscini imbottiti. Telaio in legno ed imbottitura in piuma, rivestimento in pelle o velluto. Disponibili anche con bottonatura interna ed esterna su schienale e braccioli. Fascette perimetrali disponibili in Ebano lucido, vetro verniciato (colori di serie), vetro carbonio, vetro Mesh o antique mirror con incisioni dorate.

Collection made up of sofa and armchair with padded seat cushions. Wooden structure and feather padding, covered in leather or velvet. Available also with deep buttoning on both back and arms, inside and outside. Stripes available in shiny Ebony finish, lacquered glass (standard colours), Carbon glass, Mesh glass or Antiqued mirror with engraved gold decorations.







fascette perimetrali • strips

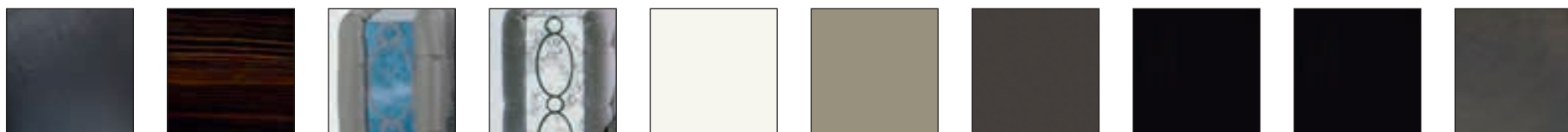

rivestimento • upholstery

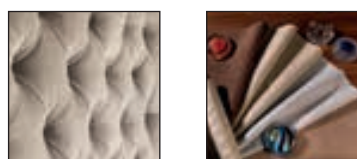

Velluto - velvet
 Pelle C
 Pelle Nabuk
 Pelle colorata

SCHEDA TECNICA • TECHNICAL DRAWINGS

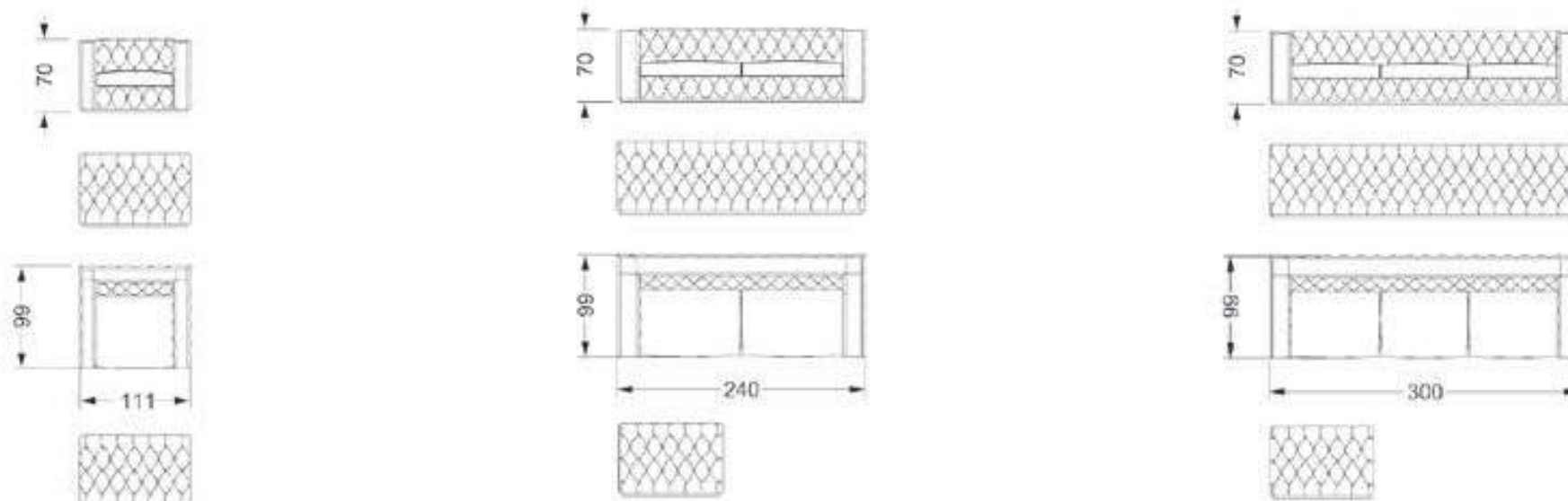

AVANTGARDE SOFA

Disegno Reflex

Collezione composta da divano e poltrona con telaio in legno ed imbottitura in piuma con inserto in poliuretano espanso. Rivestimento in pelle o in velluto con trapuntatura "San Marco" su seduta e schienale. Base in acciaio inossidabile

Collection made up of sofa and armchair with wooden structure and feather padding with details in foam polyurethane. Leather or velvet upholstery with San Marco quilting on seat and back. Base in polished inox-steel.







rivestimento • upholstery

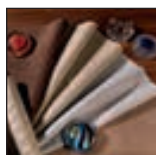
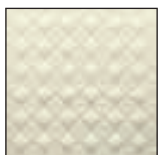

Velluto - velvet
 Pelle C
 Pelle Nabuk
 Pelle colorata
 Pelle Dune

SCHEDA TECNICA • TECHNICAL DRAWINGS

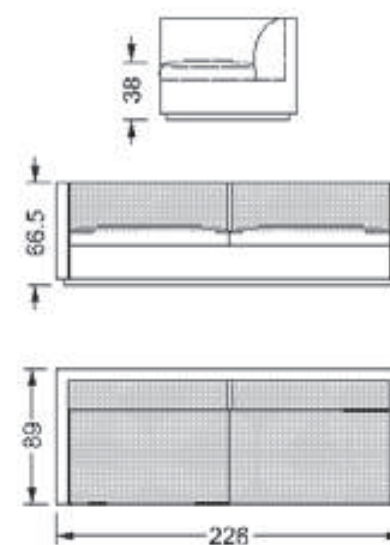
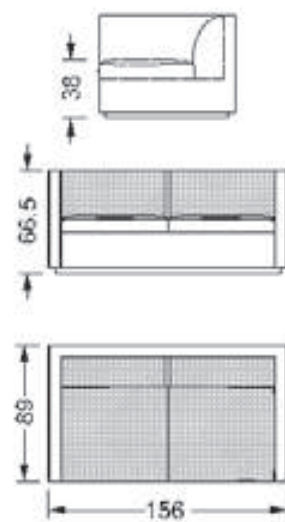
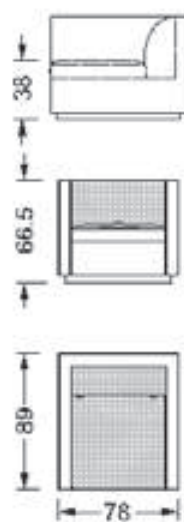

BELLE EPOQUE SOFA

Disegno Studio Viganò

Divano modulare con struttura in legno rivestita in tessuto, velluto o pelle. Cuscini imbottiti su schienale e seduta. Zoccolo in ottone antico scuro, decori sagomati in Ebano lucido o in legno laccato lucido. Dettagli in metallo finitura oro satinato. Opzionale: tavolino laterale incorporato con top in tinta con i decori. Disponibile anche nella versione con lampada dotata di paralume in tessuto pongé (avorio o nero) e lampadina a LED.

Modular sofa with wooden structure, covered in fabric, velvet or leather. Padded cushions on the back and on the seat. Plinth in antiqued dark brass, shaped decoration in shiny Ebony or in shiny lacquered wood. Metal details in glazed gold finish. Optional: built-in end table with top matching with the decoration of the sofa. Available also in the version with lamp: lampshade in pongé fabric (ivory or black) and LED bulb.





SEDUTE E DIVANI / CHAIRS AND SOFAS

BELLE EPOQUE SOFA

Disegno Studio Viganò



Rivestimento • Upholstery

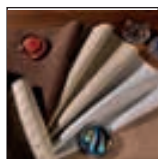

Velluto - velvet
 Pelle colorata - colored leather
 Nabuk
 Tessuti cat. Super/Extra/Luxury

dettagli • details



ottone satinato

zoccolo • base



ottone antico

decori in legno sagomato • shaped wooden decoration



nero beluga

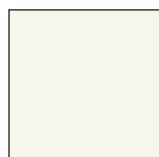

latte



fumo



henné



ebano lucido

paralume • lampshade



avorio



nero

SCHEDA TECNICA • TECHNICAL DRAWINGS

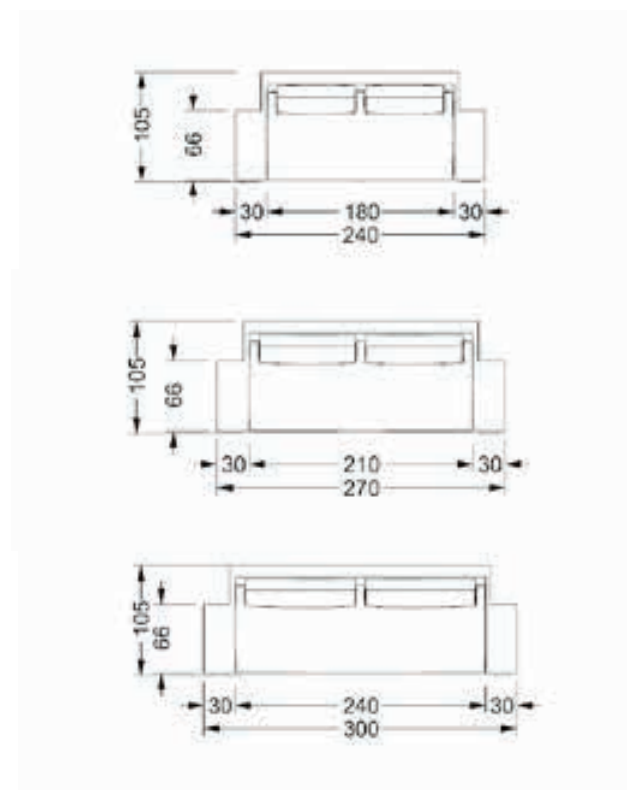

Moduli centrali
Central Modules

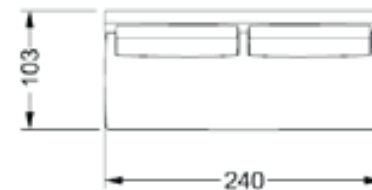
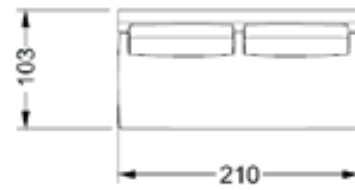
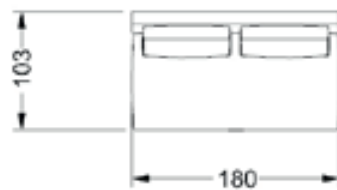

Chaise Longue

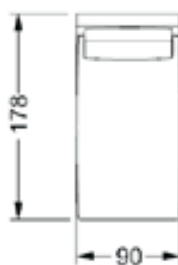
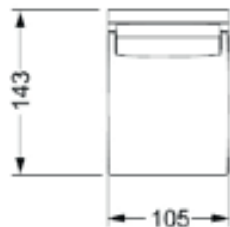

Penisola
Peninsula

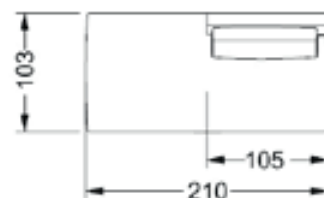
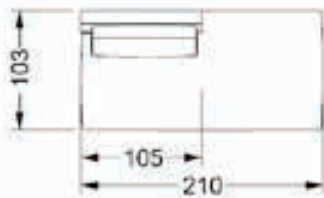

Accessori
Accessories

Pouf

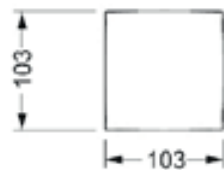

Bracciolo • Arm

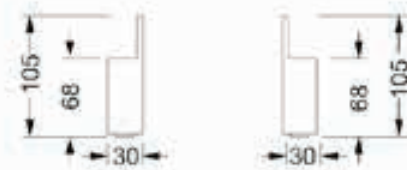

Tavolino laterale • Side table



Tavolino con lampada • Side table with lamp

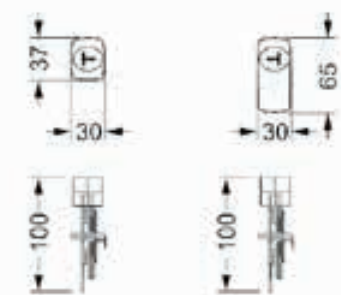

Angolare • Corner

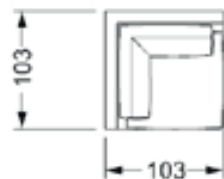

SEDUTE E DIVANI / CHAIRS AND SOFAS

SWAN SOFA E POLTRONA

Disegno Tulczinsky

Collezione composta da divani e poltrona con struttura in legno e imbottitura in piuma con inserto in poliuretano. Rivestimento in tessuto, velluto o pelle. Trapuntatura San Marco su schienale e cuscini di seduta. Base in acciaio lucido inossidabile.

Collection of padded sofas and armchair with wooden structure and feather padding with details in polyurethane foam. Upholstery in fabric, velvet or leather. Seat cushions and back with San Marco quilting. Base in polished inox-steel.



Rivestimento • Upholstery



Velluto - velvet
 Pelle C - leather C
 Pelle colorata - colored leather

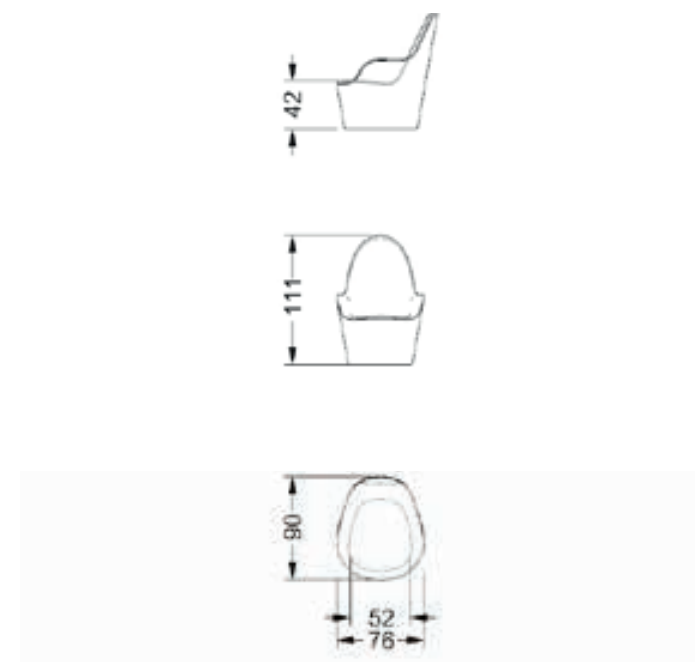
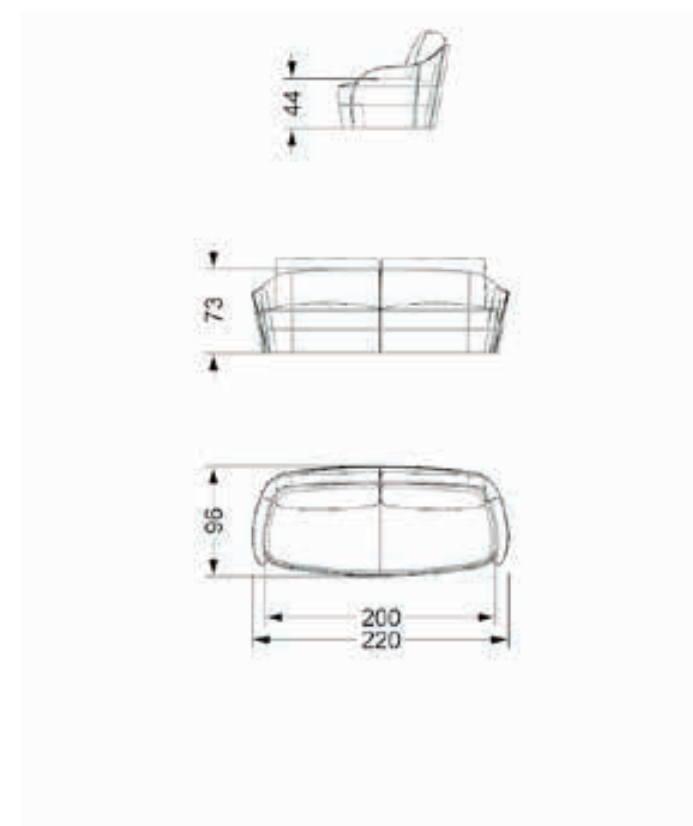

NUVOLA SOFA E POLTRONA

Disegno Tulczinsky

Divano e poltrona con struttura in legno con rivestimento in tessuto, velluto o pelle con trapuntatura San Marco opzionale per cuscini e retro-schienale. Poltrona disponibile anche con piastra girevole magnetica.

Collection made up of sofa and armchair with wooden structure upholstered in leather, fabric or velvet. Cushions padded and covered in leather, velvet or fabric, with possibility to realize the San Marco quilting on the seat cushions. Metal legs in Titanium finish.



Rivestimento • Upholstery

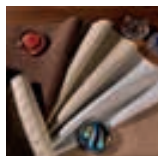

- Velluto - velvet
- Pelle colorata - colored leather
- Pelle Naturale
- Nabuk
- Tessuti cat. Super/Extra/Luxury

Piedini • Legs

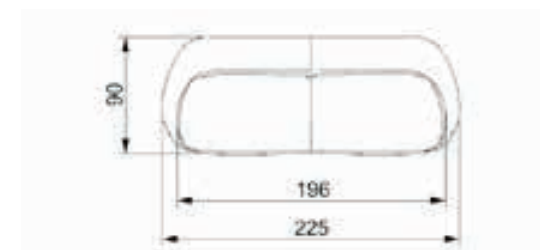
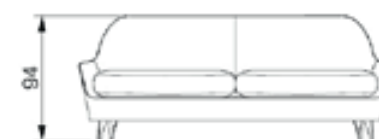
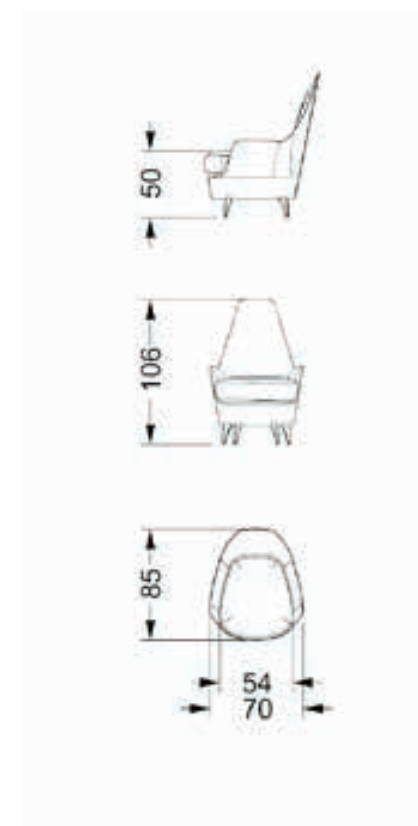

TAVOLINI CONSOLE

LOW TABLES CONSOLE

232	AENIGMA 40
234	ANDROMEDA 40
243	ARLEQUIN 40
199	AVANTGARDE CONSOLE
201	AVANTGARDE CONSOLE LONG
238	BALI console
197	BELLE EPOQUE 40
210	CASANOVA mobile console
214	CASANOVA 40 e console
212	CASANOVA 55 SPECIAL
215	CASANOVA 55
220	EPSILON
227	FILI D'ERBA 40 e console
217	FLAMBÈ console
237	FOULARD 50 e 60
236	FOULARD console
205	GRAN CANAL 40
203	GRAN CANAL 40 SPECIAL
208	GRAN CANAL bar e 55
204	GRAN CANAL CONSOLE
224	GHIBLI
233	LUCCIOLA
222	MIKADO 40
240	MISS MARPLE TROLLEY
229	NEOLITICO 40 e console
218	ROYALE console
194	SASSI 40
196	SASSI console
247	TAU 40 STEEL
248	TAU 40 STEEL SCACCHI
242	TORSADES 40
244	VENEZIA CONSOLE

SASSI 40

Disegno Riccardo Lucatello

Tavolino salotto con base in Ebano lucido spessore 80mm, angoli arrotondati. Sei gambe in vetro di Murano finitura Calcedonio o ambra. Piano in vetro extrachiaro spessore 12 mm bisello 45° e angoli arrotondati R50 mm.

Coffee table with base in shiny Ebony wood, 80mm thick with rounded edges. Six legs in Murano glass Calcedonio or amber finish. Top in extra clear glass 12 mm thick. 45° bevel and R50mm rounded corners.





TAVOLINI e CONSOLE / LOW TABLES and CONSOLES

SASSI CONSOLE

Disegno Reflex

Console con base in Ebano lucido o in legno laccato lucido spessore 80mm, angoli arrotondati. Disponibile con 2 gambe in vetro di Murano finitura Calcedonio o ambra. Piano in cristallo extrachiario spessore 12mm con bisello 45°.

Console with base in shiny Ebony or in shiny lacquered wood 80mm thick, with rounded corners. Available with 2 legs in Murano glass, Calcedonio or amber finish. Extra clear glass top 12mm thick with 45° bevel.



TAVOLINI e CONSOLE / LOW TABLES and CONSOLES

BELLE EPOQUE 40

Disegno Studio Viganò

Tavolino da salotto in legno ebano lucido oppure laccato lucido con top rivestito in vetro verniciato e decoro serigrafato oro. Zoccolo in finitura ottone o titanium satinato.

Coffee table in wood, shiny ebony or in shiny lacquered finish with top covered in lacquered glass. Gold decoration. Plinth in satin brass or titanium finish.



base • base



gambe • legs

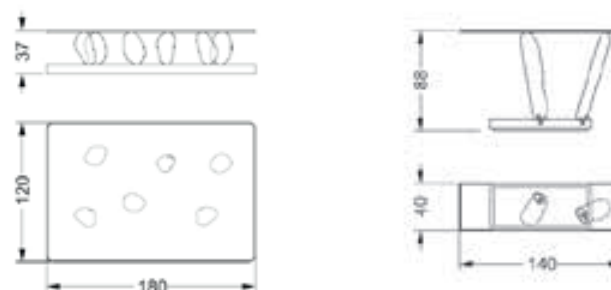
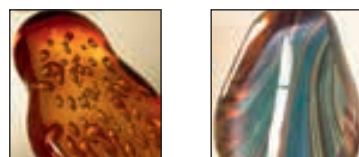

piano • top

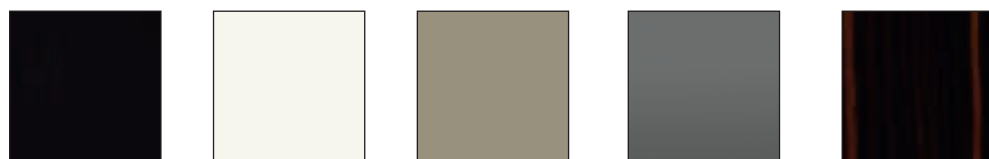

nero beluga

latte

fumo

henné

ebano lucido

dettagli • details



ottone satinato

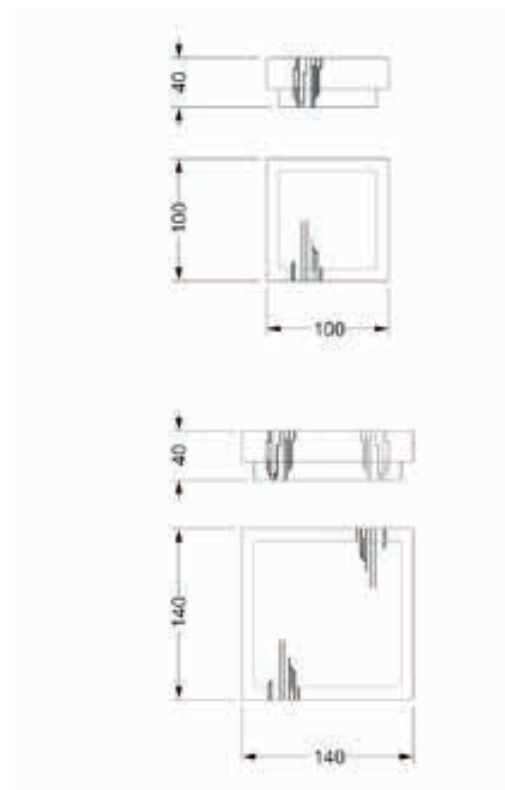

CONSOLE / CONSOLES

AVANTGARDE CONSOLE

Disegno Reflex

Console in legno laccato lucido con applicazione di vetro bisellato verniciato su frontali e top. Cassetto con vano portapenne. Disponibile anche pomolo in cristallo sfaccettato o maniglia a pendente in vetro di Murano.

Console in shiny lacquered wood with application of bevelled lacquered glass on fronts and top. Drawer with penholder. Available with round crystal handle or with pendant Murano glass handle.





AVANTGARDE CONSOLE LONG

Disegno Reflex

Console con struttura in legno laccato lucido con applicazione di vetro bisellato verniciato su frontali e top oppure in Ebano lucido. Cassetti rivestiti in vetro bisellato verniciato liscio o con incisioni oppure in Ebano lucido. Disponibili con pomoli in cristallo sfaccettato oppure maniglie a pendente in vetro di Murano.

Console in shiny lacquered wood with application of bevelled lacquered glass on fronts and top or in shiny Ebony wood. Drawers covered with bevelled lacquered glass plain or with engravings or in shiny Ebony. Available with round crystal handles or with pendant Murano glass handles.



struttura • structure

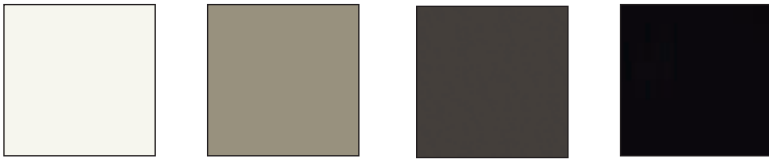

maniglie • handles

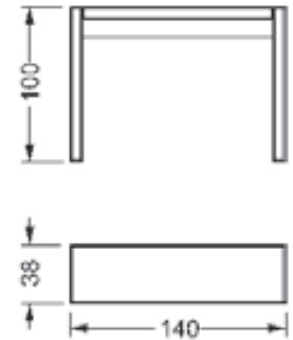

struttura e cassetti • structure and drawers



maniglie • handles

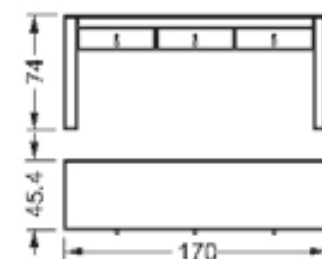
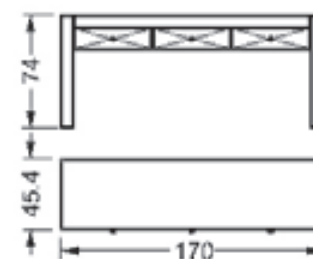
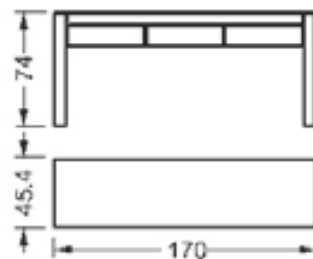

TAVOLINI e CONSOLE / LOW TABLES and CONSOLES

GRAN CANAL 40 SPECIAL

Disegno Riccardo Lucatello

Tavolino salotto con gambe in vetro di Murano trasparente liscio o rigato o in vari colori. Piano ovale in Ebano lucido a macchia aperta spessore 80mm.

Coffee table with Murano glass legs transparent plain or ribbed finish or in various colours. 80mm thick oval top in shiny Ebony wood with open grains.



TAVOLINI e CONSOLE / LOW TABLES and CONSOLES

GRAN CANAL CONSOLE

Disegno Reflex



TAVOLINI e CONSOLE / LOW TABLES and CONSOLES

GRAN CANAL 40

Disegno Riccardo Lucatello

Tavolino basso e console con gambe in vetro di Murano trasparente liscio o rigato o in vari colori. Piano in cristallo trasparente.

Coffee table and console with Murano glass legs transparent plain or ribbed finish or in various colours. Transparent glass top.



gambe • legs



gold special

piano special • top special



40

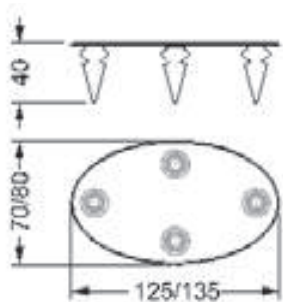
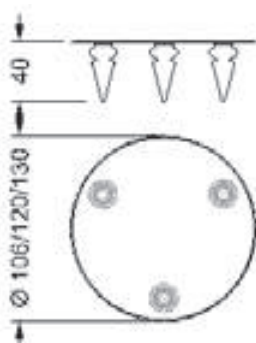
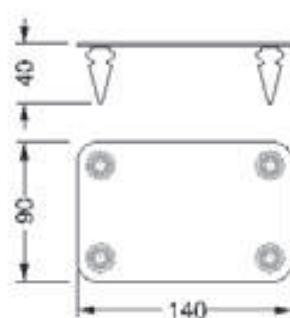
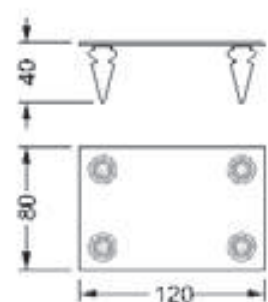
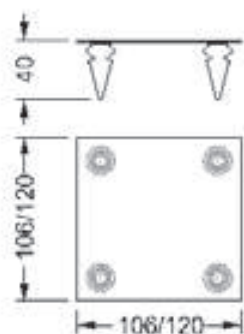

40 SPECIAL

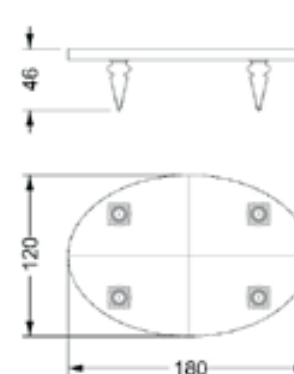

CONSOLE

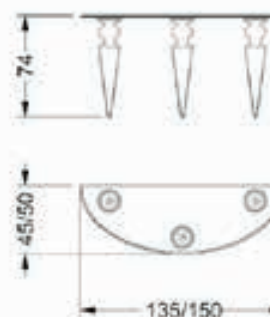

TAVOLINI e CONSOLE / LOW TABLES and CONSOLES

GRAN CANAL 55

Disegno Reflex



GRAN CANAL BAR e 55

Disegno Riccardo Lucatello

Tavolo bar e tavolino laterale con gamba centrale in vetro di Murano trasparente liscio o rigato o in vari colori. Base in cristallo trasparente, a specchio o verniciato. Piano in cristallo in varie finiture.

Bar and side tables with Murano glass leg transparent plain or ribbed finish or in various colours. Base in transparent or mirror or lacquered glass. Glass top in various finishes.



gambe • legs



only for
Gran Canal 55

gold special

base e piano • base and top



BAR

55

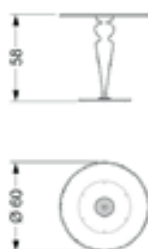
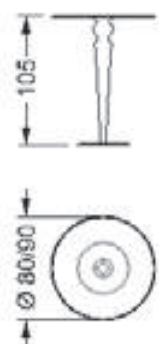

TAVOLINI e CONSOLE / LOW TABLES and CONSOLES

CASANOVA MOBILE CONSOLE

Disegno Reflex

Console con gambe in vetro di Murano con finitura lucida trasparente liscia o rigata o in vari colori. Struttura in vetro extrachiaro a specchio o verniciato nei colori di serie. Decorì in vetro di Murano lavorati a mano, disponibili nella versione trasparente o in tinta con le gambe o in oro zecchino. Optional: illuminazione a LED per i decorì.

Console with Murano glass legs available in transparent smooth or ribbed or in various colours. Structure in extra clear mirror glass or painted in the standard colours. Decorations in handmade Murano glass, available in transparent glass or in the same colours as the legs or in fine gold finish. Optional: LED lighting for decorations.



gambe • legs



gold special

piano • top

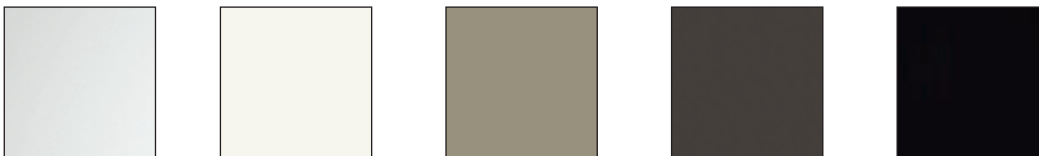

decori • decorations

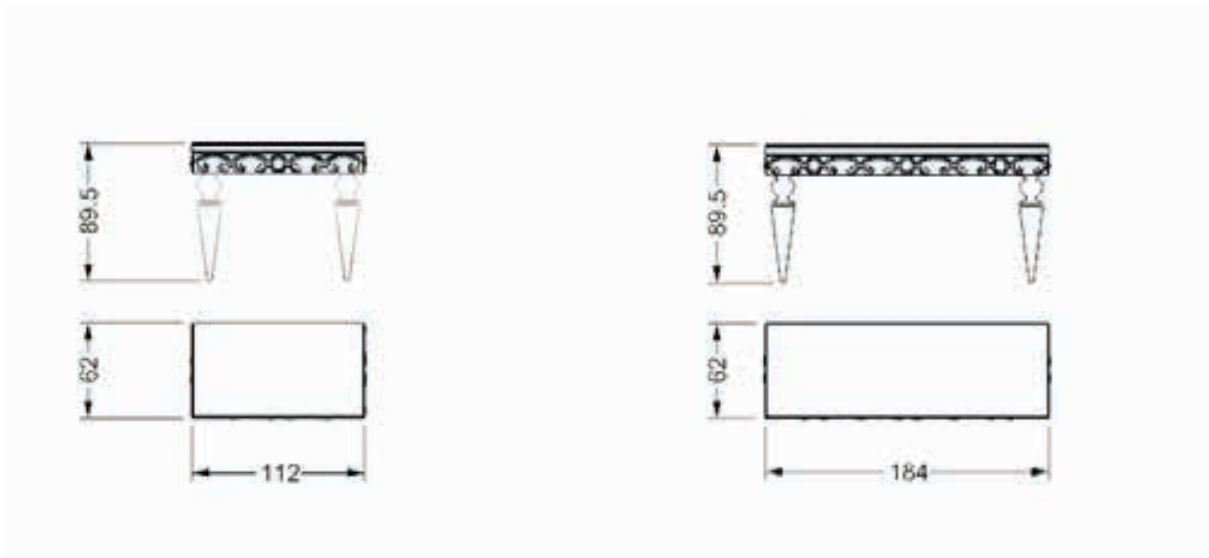

TAVOLINI e CONSOLE / LOW TABLES and CONSOLES

CASANOVA 55 SPECIAL

Disegno Reflex





TAVOLINI e CONSOLE / LOW TABLES and CONSOLES

CASANOVA 40 e CONSOLE

Disegno Reflex

Tavolino e console con gambe in vetro di Murano trasparente o oro, lavorate a mano secondo un disegno tradizionale veneziano. Base sagomata in cristallo a specchio fumé. Top in cristallo extrachiaro sp. 12mm bisello 45°.

Coffee table and console with legs in transparent or gold Murano glass with traditional venetian handmade design. Shaped base in smoked mirror glass. Top in extra clear glass 12mm thick with 45° bevel.



TAVOLINI e CONSOLE / LOW TABLES and CONSOLES

CASANOVA 55

Disegno Reflex

Tavolino terminale con gamba in vetro di Murano trasparente o oro. Base a specchio fumé. Piano in vetro extrachiaro sp. 10 mm bisello 45°.

Side table with leg in transparent or gold Murano glass. Base in smoked mirror glass. Top in extra clear glass 10 mm thick with 45° bevel.



gambe • legs

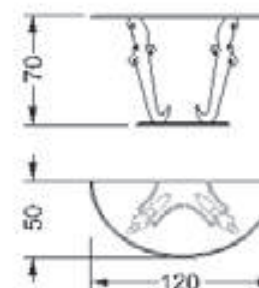
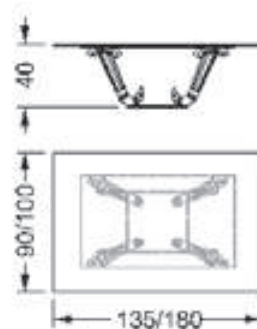
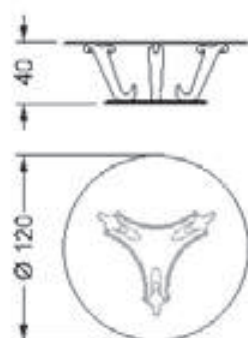

CASANOVA 55 e 55 SPECIAL

gambe • legs

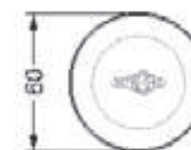
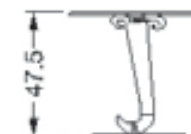

TAVOLINI e CONSOLE / LOW TABLES and CONSOLES

FLAMBE' CONSOLE

Disegno Riccardo Lucatello

Console sospesa con fissaggio a muro. Base a 3 elementi in vetro di Murano trasparente o oro zecchino. Piano in vetro extrachiario sagomato.

Hanging console with base made up of 3 Murano glass elements in transparent or fine-gold finish. Top in extra clear shaped glass.



TAVOLINI e CONSOLE / LOW TABLES and CONSOLES

ROYALE CONSOLE

Disegno Riccardo Lucatello

Console composta da elementi in vetro di Murano lavorati a mano nelle finiture trasparente o oro zecchino. Zoccolo in cristallo specchio fumé. Piano in cristallo extrachiaro trasparente spessore 12mm bisello 45°.

Console made up of handmade Murano glass elements in transparent or fine-gold finish. Plinth in smoked mirror glass. Top in extra clear transparent glass 12mm thick 45° bevel.



gambe • legs

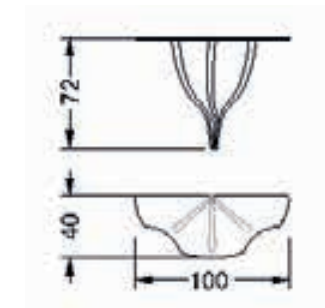
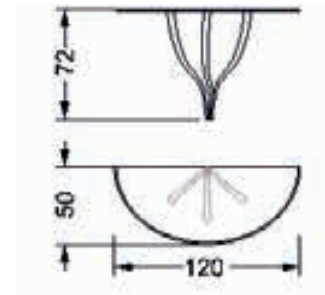

gambe • legs

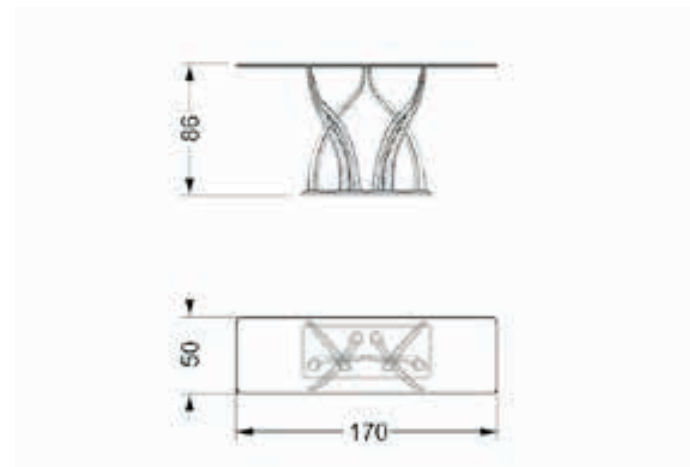
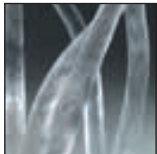

EPSILON 40

Disegno Maurice Barilone

Tavolino con base in vetro di Murano filo colore lucido verde o nero oppure in colore pieno trasparente, blu o verde con finitura lucida o acidata. Disponibile anche in vetro rigato trasparente, tè o oro. Piano in vetro trasparente.

Coffee table with base in Murano glass clear with green or black thread, or in full colour clear, blue or green in glossy or frosted finish. Legs available also in ribbed glass transparent, tea or gold colour. Top in transparent glass



gambe colore pieno acidato e lucido • legs in full colour, shiny or etched



trasparente
transparent

gambe lucido filo colore • clear glass legs with coloured thread



gambe rigato • ribbed legs



SCHEDA TECNICA • TECHNICAL DRAWINGS

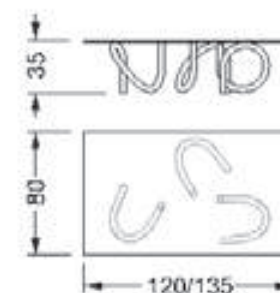
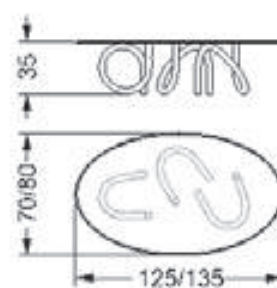
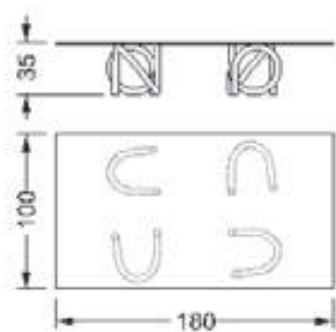
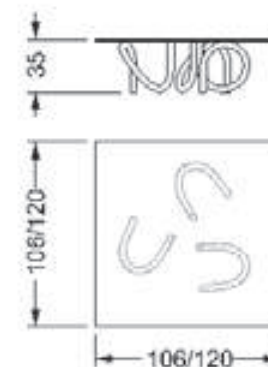
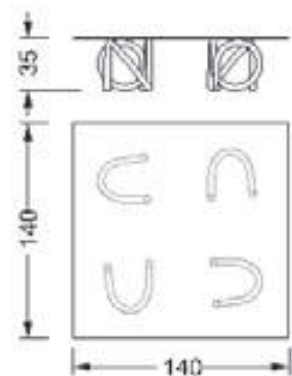

TAVOLINI e CONSOLE / LOW TABLES and CONSOLES

MIKADO 40

Disegno Maurice Barilone

Tavolino con base in vetro extrachiaro crackelé. Piano in vetro trasparente di spessore 12 mm.

Coffee table with base in extra-clear crackled glass. Glass top 12 mm thick.

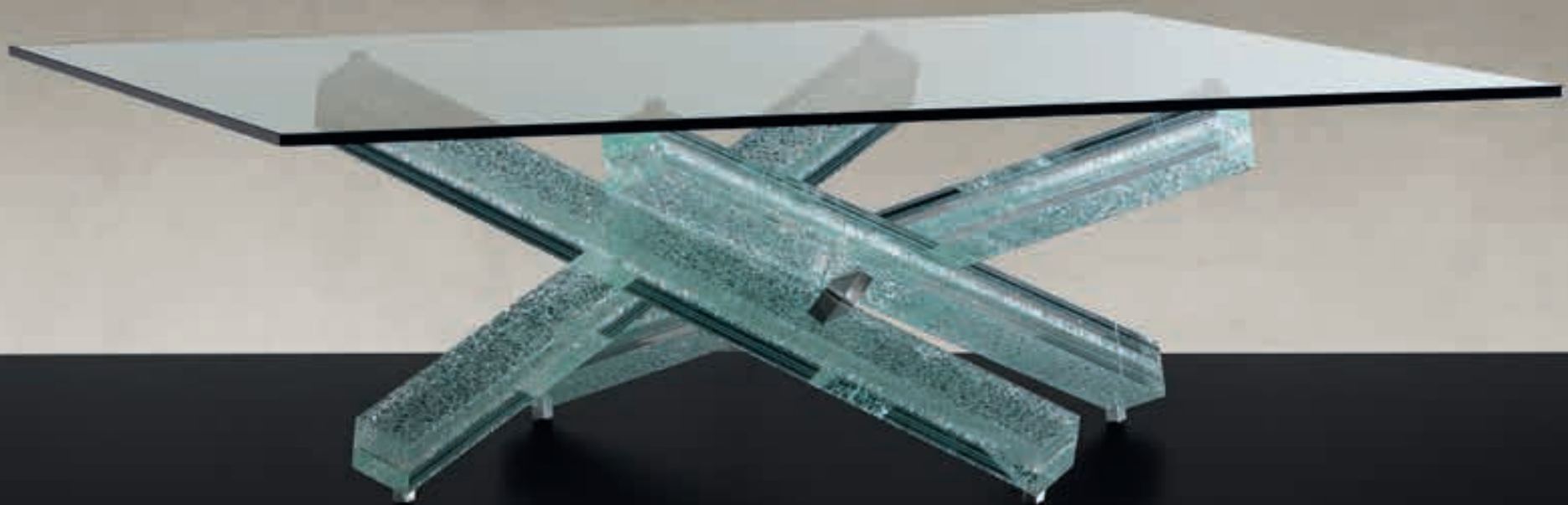

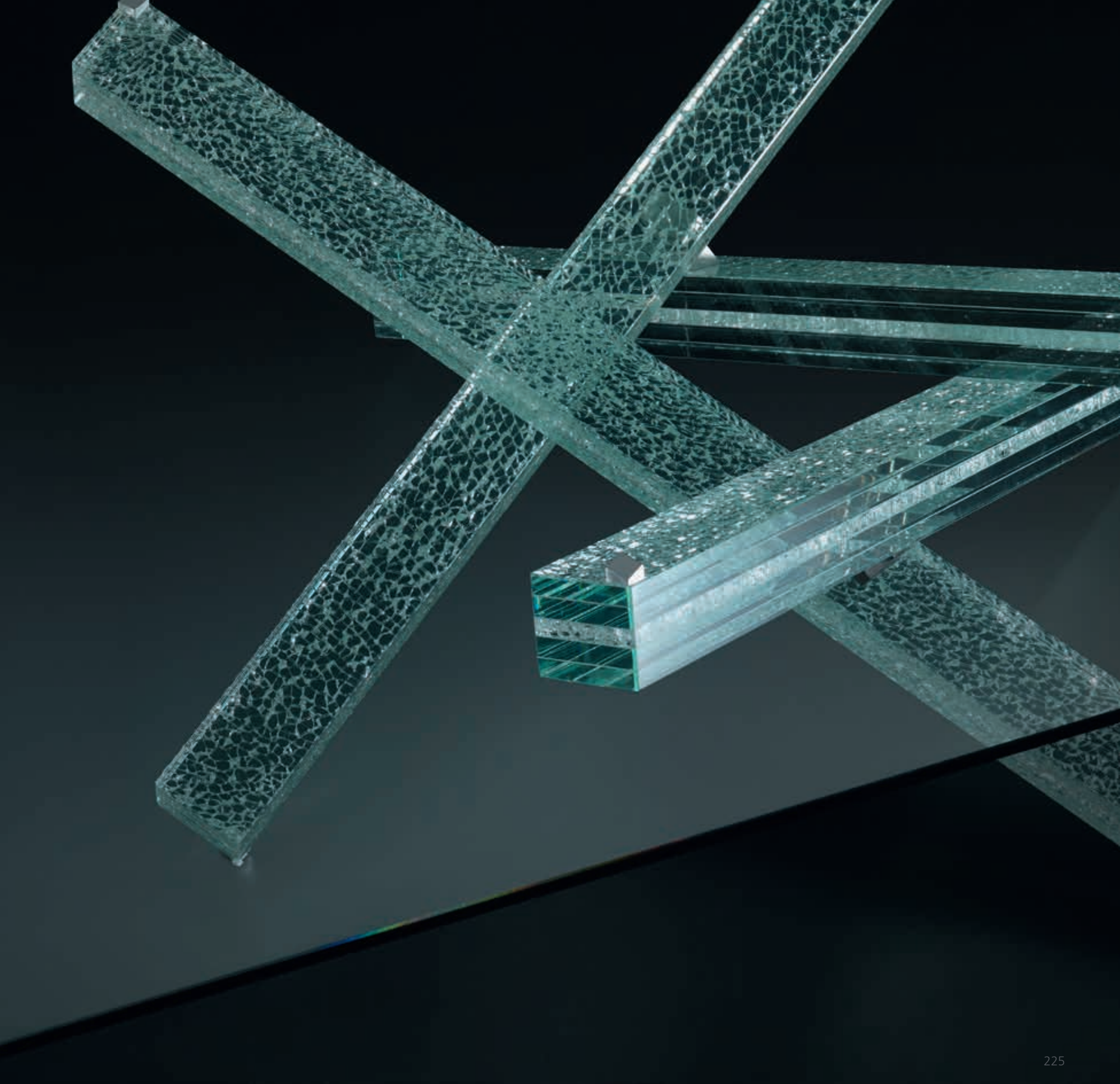

TAVOLINI e CONSOLE / LOW TABLES and CONSOLES

GHIBLI

Disegno Tulczinsky

Tavolino con base in vetro di Murano con lavorazione rigata trasparente o nei colori nero, ametista, tè o oro. Piano in vetro spessore 10 mm con bisello 45°.

Side table with Murano glass base in ribbed finish transparent, black, amethyst, gold or tea. Glass top 10 mm thick with 45° bevel





base • base

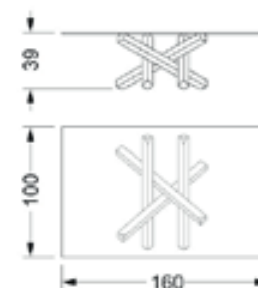
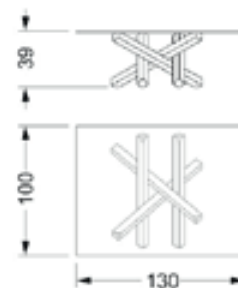
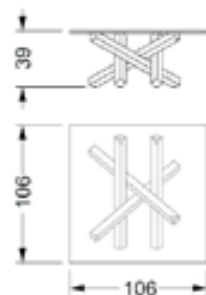
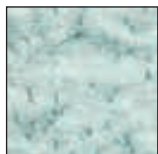

gambe rigate • ribbed legs



TAVOLINI e CONSOLE / LOW TABLES and CONSOLES

FILI D'ERBA 40 e CONSOLE

Disegno Tulczinsky

Tavolino da salotto e console con base in vetro di Murano disponibile in varie combinazioni o nelle speciali finiture Rugiada, Oro & Murrine o Calcedonio. Piano in vetro trasparente.

Coffee table and console with Murano glass base available in different colour combinations or in the special Rugiada, Gold & Murrine or Calcedonio finish. Top in transparent glass.



gambe tavolino • cocktail table legs



gambe console • console legs

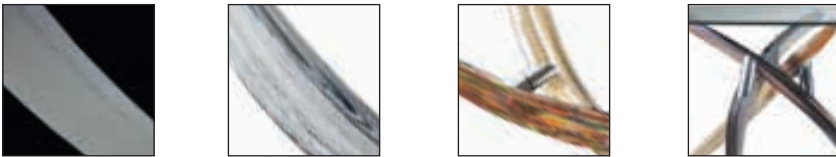

SCHEDA TECNICA • TECHNICAL DRAWINGS

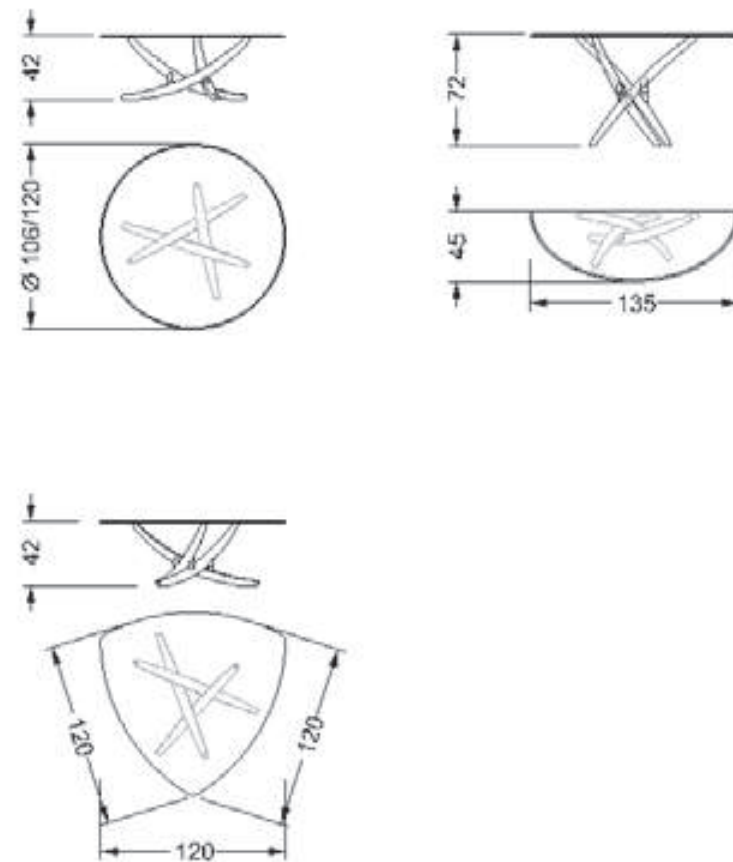

TAVOLINI e CONSOLE / LOW TABLES and CONSOLES

NEOLITICO CONSOLE

Disegno Tulczinsky

Console con basamento in vetro trasparente o verniciato nero. Entrambi sono disponibili anche con base in ferro battuto finitura Grafite, Corten, acciaio naturale, foglia oro o argento. Piano in cristallo con bisello 45°.

Console with base in transparent or black lacquered glass. Both models are available also with base in forged iron in Grafite, Corten, steel finish, gold or silver leaf finish. Glass top with 45° bevel.



NEOLITICO 40

Disegno Tulzinsky

Tavolino con basamento in vetro curvato nelle versioni extrachiaro trasparente o acidato, verniciato o acidato verniciato nei colori di serie.

Coffee table with base in curved glass, available in extra clear transparent or etched glass, in lacquered or etched lacquered glass in standard colours.



base vetro • glass base



base ferro battuto • forged iron base



SCHEDA TECNICA • TECHNICAL DRAWINGS

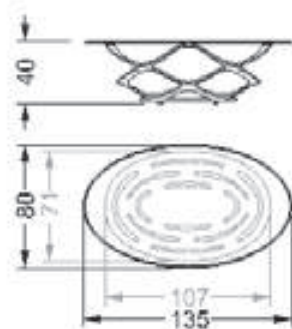
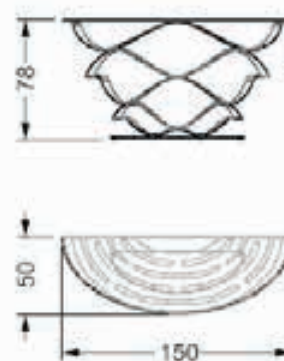
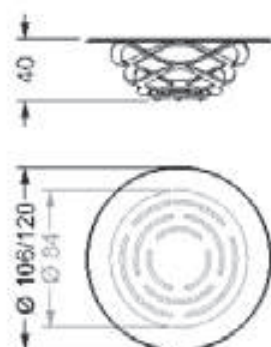

AENIGMA 40

Disegno Reflex

Tavolino con base composta da elementi curvati in finitura wenge, rame lucido, nickel-nero lucido o ottone satinato. Piano in vetro trasparente.

Coffee table with base composed by curved elements in wengé finish or in shiny copper, shiny black nickel or satin brass finish. Top in transparent glass.



LUCCIOLA 55

Disegno Reflex

Tavolino con elemento centrale in vetro di Murano lavorato a mano trasparente o oro, sabbato all'estremità superiore. Base tonda in vetro con finitura a specchio. Impianto luce LED. Top in cristallo spessore 10 mm con bisello 45°.

End table with central rod in handmade Murano glass transparent or gold, frosted on the top. Round base in mirror finish. Equipped with LED lighting system. Glass top 10 mm thick with 45° bevel.



ANDROMEDA 40

Disegno Tulczinsky

Tavolino con base in materiale granitico scolpito e bocciardato a mano. Piano in cristallo sp. 12 mm con bisello 45°.

Coffee table with base in carved granitic material. Glass top 12 mm thick with 45° bevel.



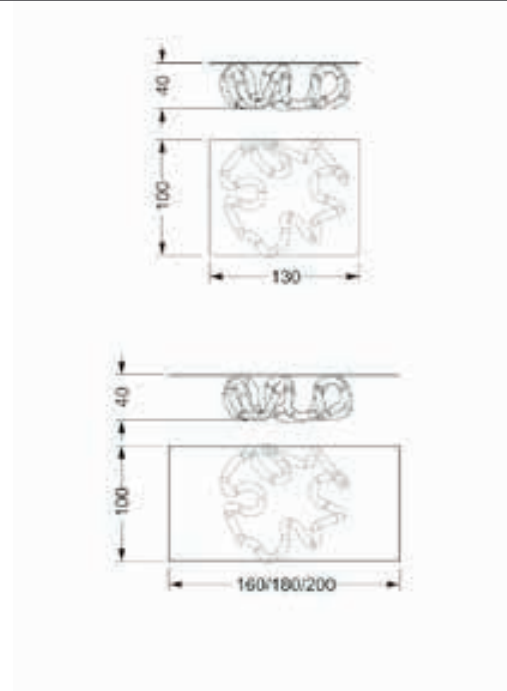
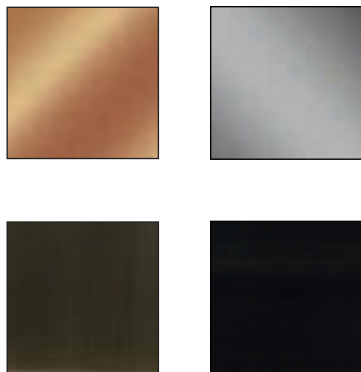

base • base



supporto • support

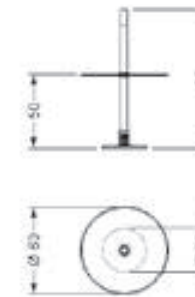
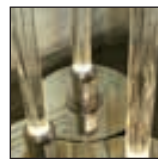

base • base

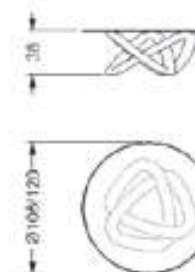

TAVOLINI e CONSOLE / LOW TABLES and CONSOLES

FOULARD CONSOLE

Disegno Reflex

Console in vetro curvato spessore 10mm
extrachiaro, bronzo o fumé con finitura
acidata.

Console in curved 10 mm thick extra-clear,
smoke or bronze glass with etched finish.



TAVOLINI e CONSOLE / LOW TABLES and CONSOLES

FOULARD 50 - 60

Disegno Reflex

Tavolini laterali in vetro curvato extrachiario, bronzo o fumé con finitura acidata.

Side tables in curved glass available in extra clear, bronze or smoked glass with etched finish.



CONSOLE/ CONSOLE

BALI CONSOLE

Disegno Tulczinsky

Console con basi in vetro di Murano massiccio multicolore o in finitura Rugiada. Piano in cristallo spessore 15mm con bisello 45°.

Console with bases in solid Murano glass, multi-coloured or Rugiada finish. Glass top 15mm thick with 45° bevel.



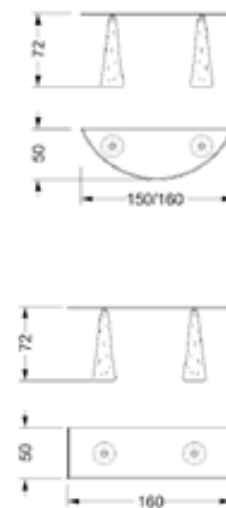
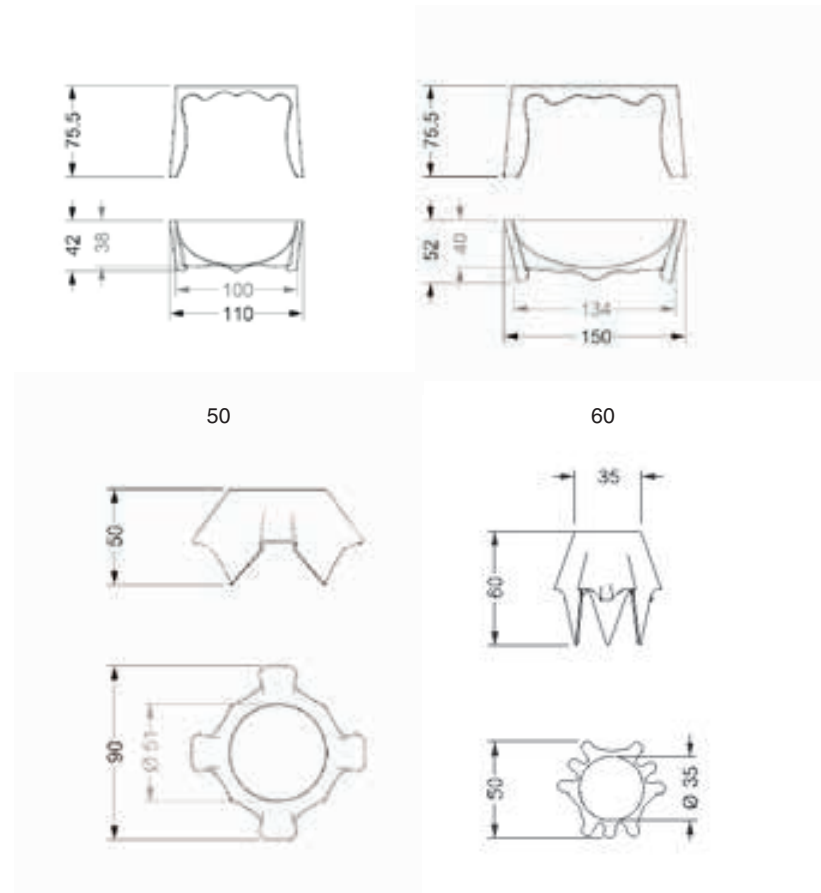

TAVOLINI e CONSOLE / LOW TABLES and CONSOLES

MISS MARPLE TROLLEY

Disegno Tulczinsky

Carrello con struttura in acciaio lucido oppure in finitura ottone satinato. Dotato di 2 ripiani/vassoi in vetro extrachiario e optional ripiano portabottiglie in metallo.

Trolley with structure in shiny steel or in satin brass finish. Equipped with 2 shelves/trays in extra clear glass. Optional the bottle-shelf in metal.



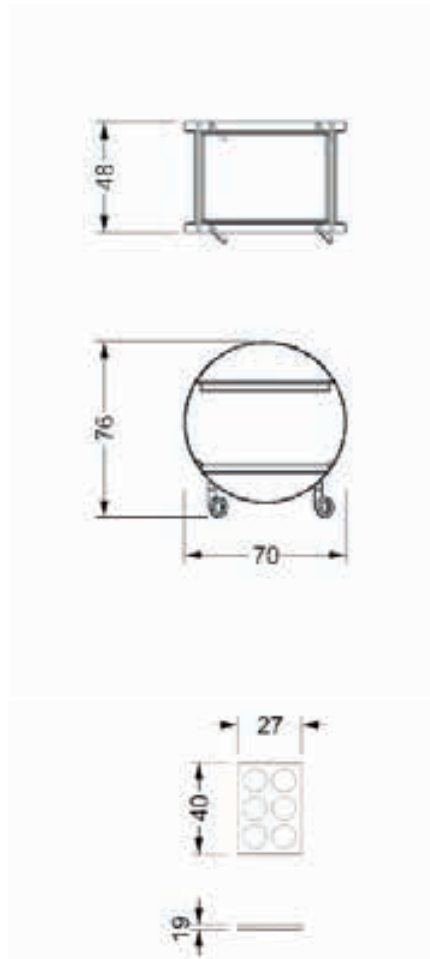

TORSADES 40

Disegno Maurice Barilone

Tavolino con base in vetro di Murano nei colori: bianco sabbato oppure rigato trasparente, tè o oro. Piano in vetro spessore 12 mm con bisello 45°.

Coffee table with Murano glass base available in white sandblasted or ribbed transparent, tea or gold. Glass top 12 mm thick with 45° bevel.



ARLEQUIN 40

Disegno Maurice Barilone

Tavolino con base in vetro di Murano liscio nei colori: blu, verde, rosso, trasparente con finitura lucida o sabbata. Anello in vetro di Murano verde, blu o bianco con finitura sabbata. Base disponibile anche con lavorazione rigata nei colori trasparente, tè o oro. Piano in vetro spessore 12 mm

Coffee table with base available in blue, green, red, transparent or white sandblasted Murano glass. Ring in white, blue or green sandblasted glass. Base available also in ribbed transparent, tea or gold Murano glass. Glass top 12 mm thick.



VENEZIA CONSOLE

Disegno Tulczinsky

Console con base in vetro di Murano multicolore. Zoccolo in legno laccato lucido beluga. Piano in cristallo extrachiaro spessore 12mm bisello 45°.

Console with base in multicoloured Murano glass. Wooden plinth in nero beluga shiny lacquered finish. Top in 12mm thick extra clear glass with 45° bevel.



Piano • Top



Base • Base

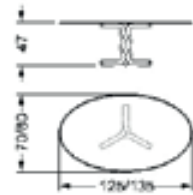
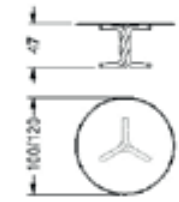
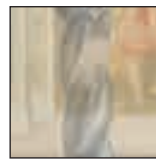
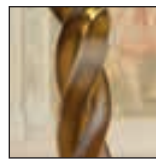
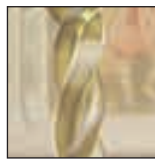

Piano • Top



Base • Base

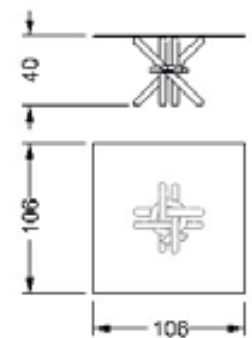
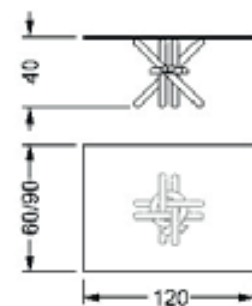
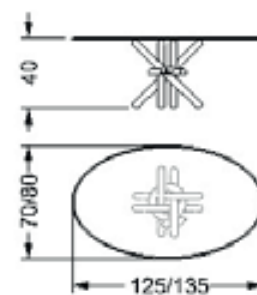
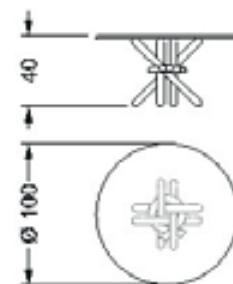
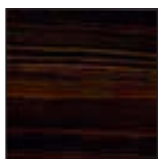

Piano • Top



Base • Base



Zoccolo • Plinth



SCHEDA TECNICA • TECHNICAL DRAWINGS

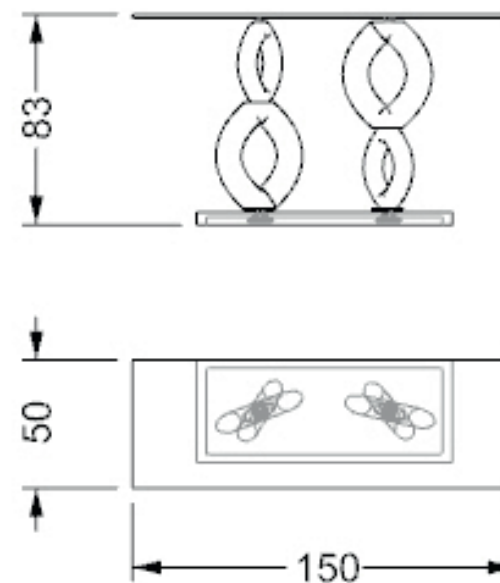

TAU 40 STEEL

Disegno Riccardo Lucatello

Collezione di tavolini da salotto e terminali con base a cilindro nelle finiture metalliche satinare ottone o titanium. Piano in legno in tinta con bordo sp.40mm con inserto in vetro verniciato o acidato verniciato oppure in vetro Marmo.

Collection of low and side table with cylinder base in the satin brass or titanium finishes. Wooden top in same finish with 40mm thick edge with inlay in lacquered or etched lacquered glass or in Marble glass.



TAVOLINI e CONSOLE / LOW TABLES and CONSOLES

TAU 40 STEEL SCACCHI

Disegno Riccardo Lucatello

Tavolino con base a cilindro nelle finiture metalliche satiniate ottone o titanium.
Piano in legno in tinta con bordo sp.40 mm con inserto in vetro Marmo a scacchiera.

Side table with cylinder base in the satin brass or titanium finishes.
Wooden top in same finish with 40mm thick edge with inlay in Marble glass with chessboard design.



Tau 40 steel scacchi

Piano • Top

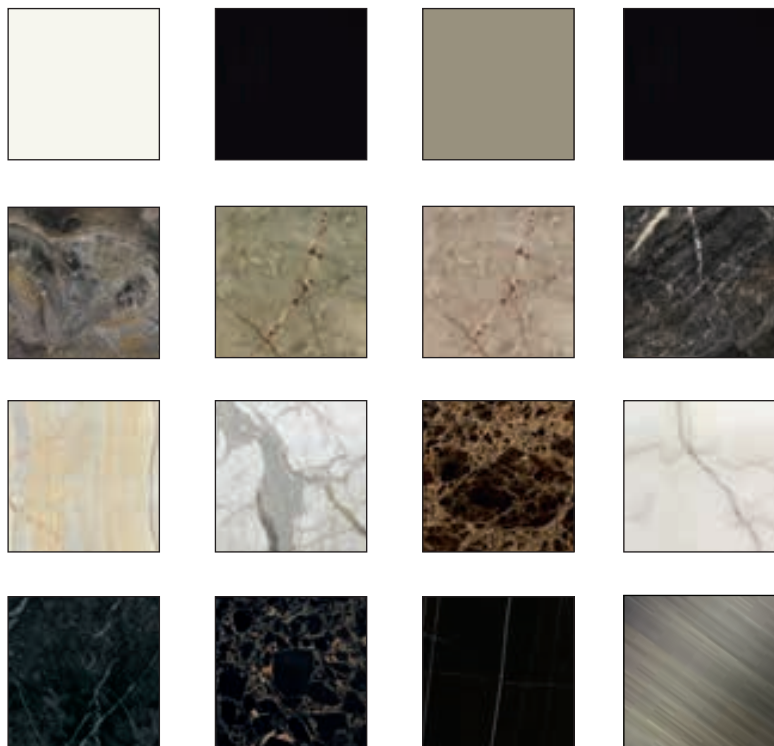

Piano • Top



Base • Base

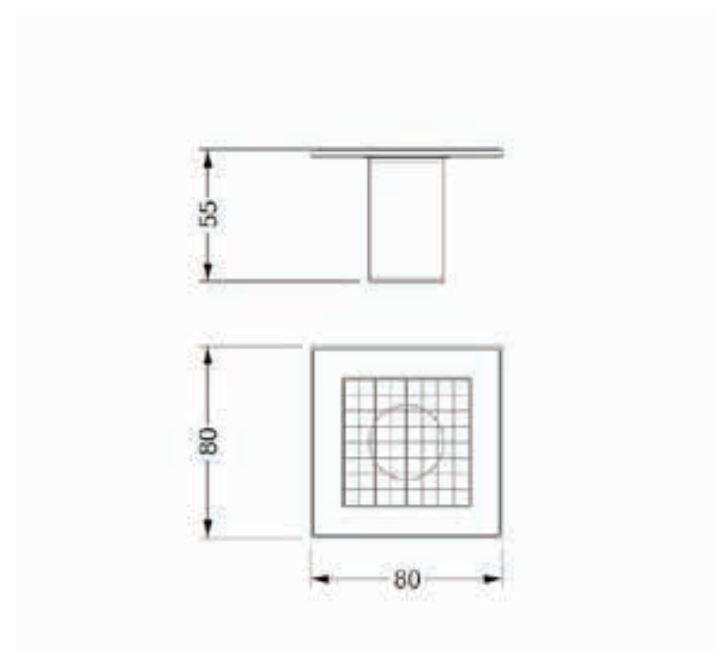
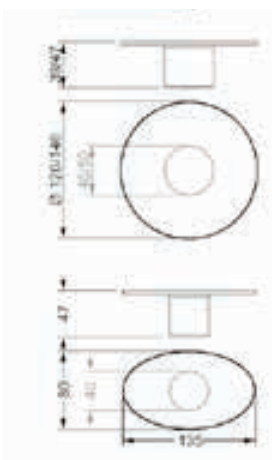
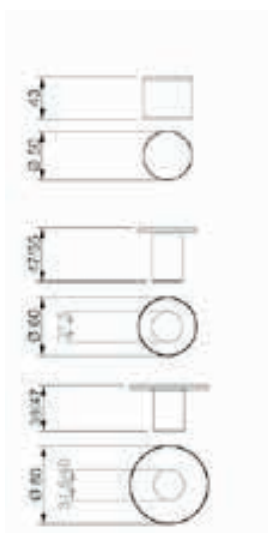

UFFICIO

OFFICE

252	<i>ARK scrivania</i>
254	<i>ARK buffet</i>
256	<i>LUCE scrivania</i>
260	<i>MACH 5</i>
258	<i>PEGASO scrivania</i>
261	<i>TWIST</i>

OFFICE

ARK SCRIVANIA

Disegno Massimo Scolari

Scrivania con struttura in Noce Canaletto o Ebano lucido. Piano di finitura in Noce Canaletto, Ebano lucido, vetro acidato verniciato nei colori di serie o in marmo. Dotato di vano apribile per alloggiamento prese e connessioni e bordo rivestito in pelle. Contenitore con cassetto e schedario con bordi e dettagli in acciaio. Disponibile nella versione con gamba in vetro di Murano nero (versione A), con cassetiera girevole (versione B) o con predisposizione per Ark buffet (versione C).

Desk with structure in Canaletto walnut or in shiny Ebony. Top in Canaletto walnut, shiny Ebony, etched lacquered glass finish, standard colours, or in marble. Equipped with drawer for plugs and connections and edge covered in leather. Unit with drawer and filing-drawer with edges and details in steel. Available in the version with leg in black Murano glass (A version), with turning chest of drawers (B version) or with equipment to install Ark buffet (C version).





OFFICE

ARK BUFFET

Disegno Massimo Scolari

Buffet con struttura in Noce Canaletto o in Ebano lucido. Bordi di piano e fondo rivestiti in pelle. Dotato di un vano laterale con anta a battente e ripiano interno, un vano centrale con cestello girevole portabottiglie e un ulteriore vano laterale con 3 cassetti. Top disponibile nelle finiture Noce Canaletto, Ebano lucido, vetro verniciato acidato, vetro Mesh o in marmo. Piedini in acciaio e legno.

Buffet with structure in Canaletto walnut or in shiny Ebony. Top and bottom edges covered in leather. Equipped with a side space with door and internal shelf, a central unit with turning basket for bottle-stand and another side space with 3 drawers. Top available in Canaletto walnut, shiny Ebony, etched lacquered glass, Mesh glass, or in marble. Legs in steel and wood.



struttura • structure

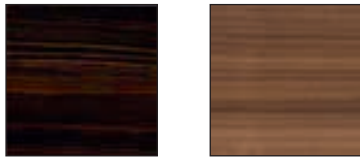

bordi e dettagli • edges and details

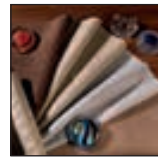

Pelle Dune
Pelle Naturale

piano • top



piano • top

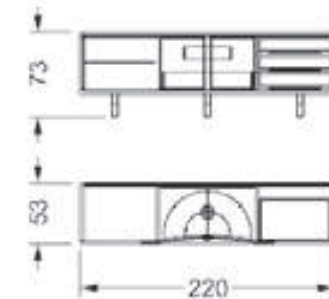
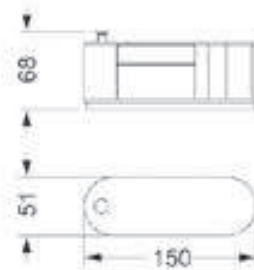
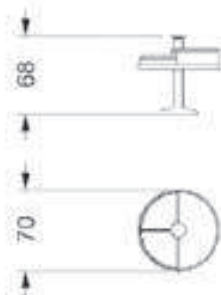
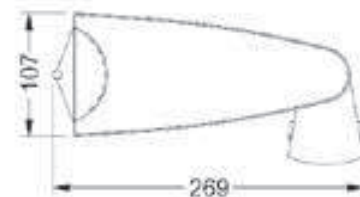
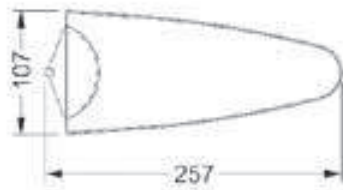
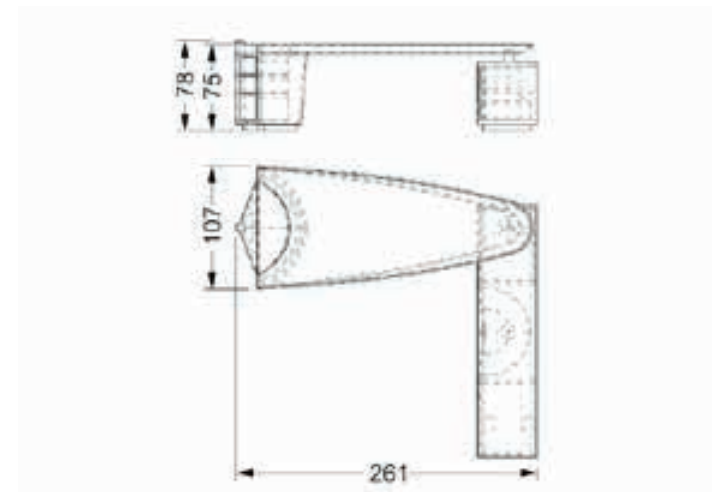
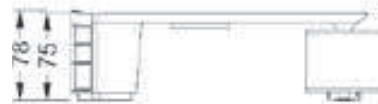
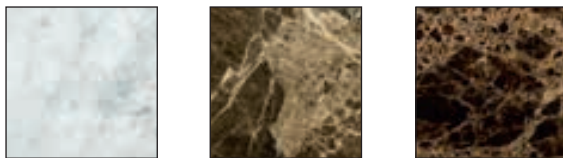

OFFICE

LUCE SCRIVANIA

Disegno Reflex

Scrivania con cassettiera singola o doppia con elementi in legno intervallati da particolari in vetro extrachiario acidato temperato con illuminazione interna, piano in legno con inserimento di top in vetro verniciato per la versione laccata lucida. Disponibile in laccato lucido, Ebano lucido o Noce Canaletto. Foro passacavo e pannello frontale curvato in legno opzionale.

Desk with single or double drawer unit with wooden elements with dividing parts in extra clear frosted tempered glass with lighting, wooden top with inserted lacquered glass top for the shiny lacquered version. Available in shiny lacquered finish, shiny Ebony or Canaletto walnut. Cable-hole and curved frontal wooden panel as option.



legno • wood

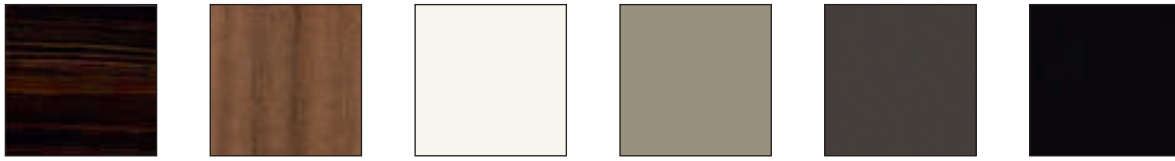

SCHEDA TECNICA • TECHNICAL DRAWINGS

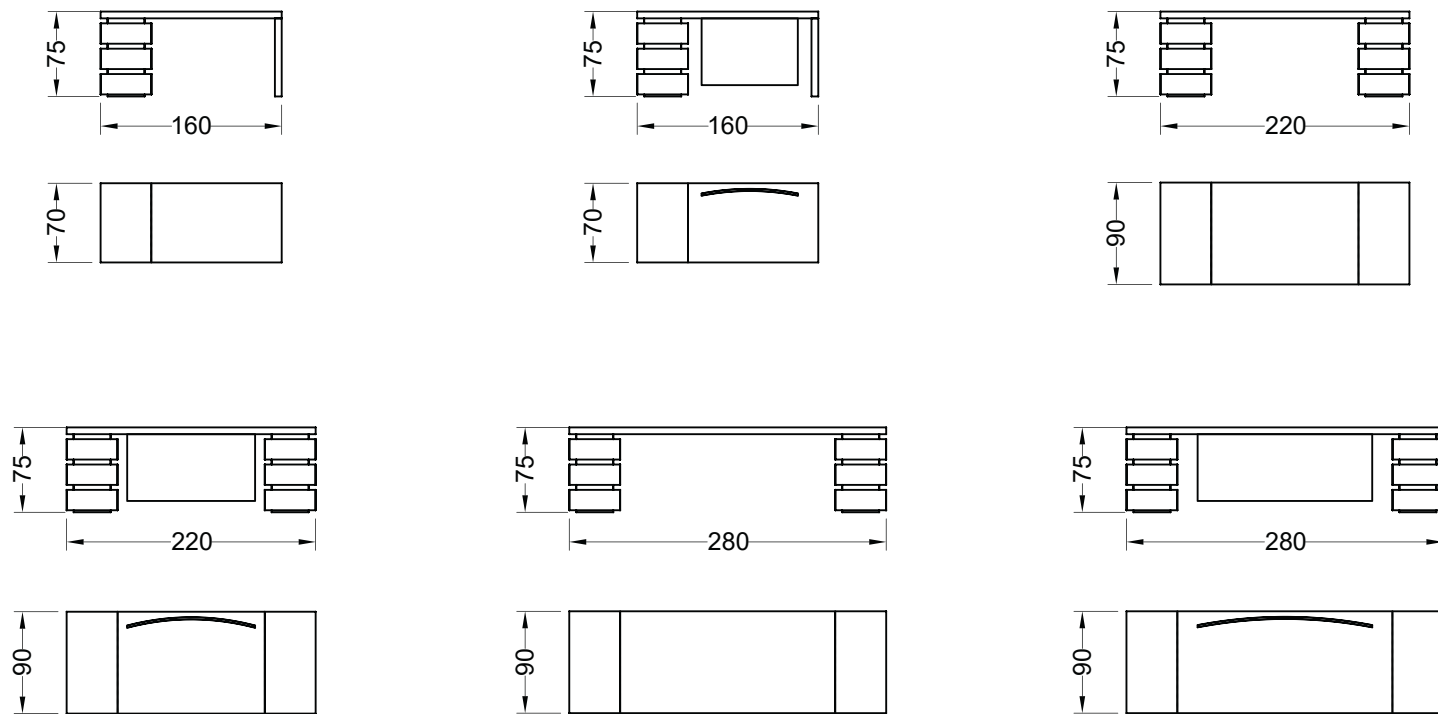

OFFICE

PEGASO SCRIVANIA

Disegno Tulczinsky

Scrivania con piano mobile in legno, un fianco in legno e un fianco in cristallo trasparente sp.19mm. Finiture disponibili: Noce Canaletto, Ebano lucido, laccato opaco. Foro passacavo opzionale.

Desk with extendible wooden top, one wooden side and one side in transparent glass 19mm thick. Finishes available: Canaletto walnut, shiny Ebony wood, matt lacquer. Cable-hole as option.



piano e fianco • top and side

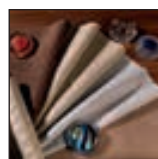
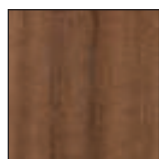

Pelle C
Pelle Nabuk
Pelle colorata
Pelle Dune

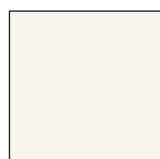

SCHEMA TECNICA • TECHNICAL DRAWINGS

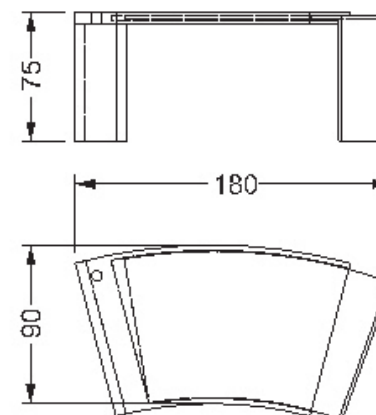
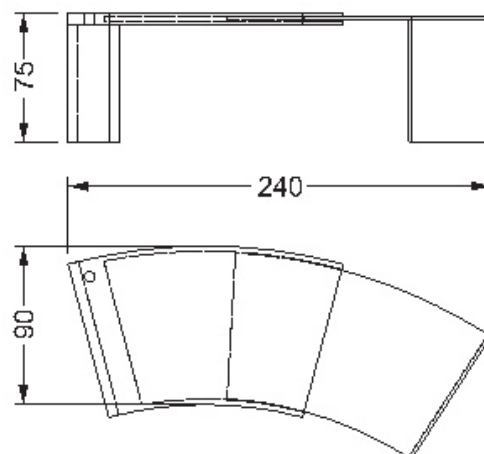

OFFICE

MACH 5

Disegno Reflex

Scrivania porta computer con base ed elementi in metallo verniciati alluminio. Disponibile anche nella versione con base verniciata nera e supporti cromo lucido. Piani sagomati in cristallo temperato di spessore 15 mm. Opzionale: ripiano girevole porta stampante in cristallo trasparente e supporto Tower.

Desk with base and elements painted in aluminium colour. Also available with black painted base and shiny chrome supports. Tempered shaped glass tops 15mm thick. Optional: swivelling shelf for printer in transparent glass and Tower support.



OFFICE

TWIST

Disegno Tulczinsky

Scrivania con top curvato in pelle Naturale o pelle Dune nero. Divisori disponibili in Noce Canaletto o Ebano lucido. Gambe in metallo finitura Grafite. Cassetti e specchietto opzionali.

Desk with curved top in Naturale leather or in black Dune leather. Dividers available in Canaletto walnut or in shiny Ebony wood. Legs in Grafite finish. Drawers and mirror as option.



base • base

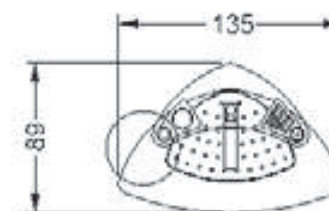

piano • top

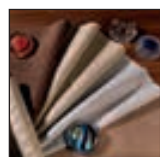

Pelle Naturale
Pelle nero Dune

gambe • legs



divisori e cassetti • divisions and drawers

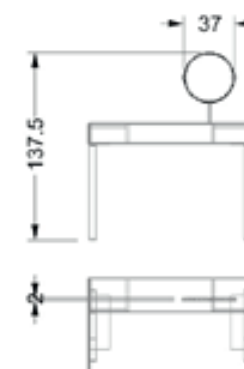
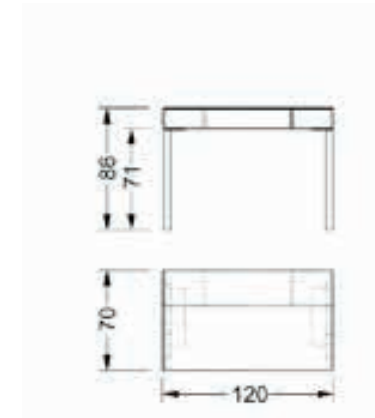

MOBILI e ZONA NOTTE

FURNITURE and NIGHT AREA

286	AVANTGARDE bar e bar special
289	AVANTGARDE bar cocktail luce
304	AVANTGARDE BUFFET
300	AVANTGARDE CREDENZA low
307	AVANTGARDE CREDENZA luce
282	AVANTGARDE LIBRERIA
293	AVANTGARDE LIBRERIA 150
296	AVANTGARDE LIBRERIA composizione
299	AVANTGARDE LIBRERIA special
302	AVANTGARDE MADIA
312	AVANTGARDE SPA
311	AVANTGARDE TOILETTE
292	AVANTGARDE TV
266	BELLE EPOQUE bar cocktail
264	BELLE EPOQUE buffet
265	BELLE EPOQUE cucina
322	CA' D'ORO BUFFET
325	CA' D'ORO MADIA ALTA
324	CA' D'ORO MADIA BASSA
275	CASANOVA ARMADIO
270	CASANOVA BUFFET
271	CASANOVA BUFFET LONG
273	CASANOVA MADIA
279	CASANOVA SPA
320	DIAMANTE BUFFET
318	DIAMANTE MADIA
314	DUNE collezione
315	DUNE CREDENZA LUCE
333	GIANO BUFFET
332	GIANO MODULARE
329	GONDOLA BUFFET
335	MIRAGE TV
327	MURANO MADIA e BUFFET
330	OCCHIO BUFFET
337	ONIS VETRINA

BELLE EPOQUE BUFFET

Disegno Studio Viganò

Buffet a 4 ante con struttura in legno laccato lucido. Decorì sagomati in legno laccato lucido a contrasto contornati da lame in metallo finitura oro satinato. Piano in vetro verniciato. Maniglie in metallo finitura oro satinato con inserto in vetro in tinta con i decori. Zoccolo in finitura ottone e ripiani interni in vetro.

Sideboard with 4 doors and structure in shiny lacquered wood. Shaped decorations in shiny lacquered wood, contrast colour, surrounded by metal bars in glazed gold finish. Top in lacquered glass. Metal handles in glazed gold finish with inlay in lacquered glass. Plinth in brass finish and shelves in transparent glass.



BELLE EPOQUE CUCINA

Disegno Studio Viganò

Cucina con struttura in legno con ante rivestite in vetro con possibilità di decoro inciso in finitura oro. Dettagli in ottone satinato e top in marmo di Cesare o altre finiture su richiesta.

Kitchen with wooden structure with doors covered in glass available also with engraved decoration in gold finish. Details in glazed brass and top in Cesare marble. Other finishes on request.



BELLE EPOQUE BAR COCKTAIL

Disegno Studio Viganò

Mobile bar con struttura in legno laccato lucido. Ante in vetro verniciato nei colori di serie e incisioni dorate. Decorì e piedini in metallo finitura oro. Schiena in vetro a specchio. Maniglie in metallo finitura oro satinato.

Bar cabinet with wooden structure in shiny lacquered finish. Glass doors in lacquered glass in the standard colours with gold engravings. Metal decoration and feet in gold finish. Back in mirror glass. Metal handles in glazed gold finish.





struttura • structure



dettagli • details



piano • top

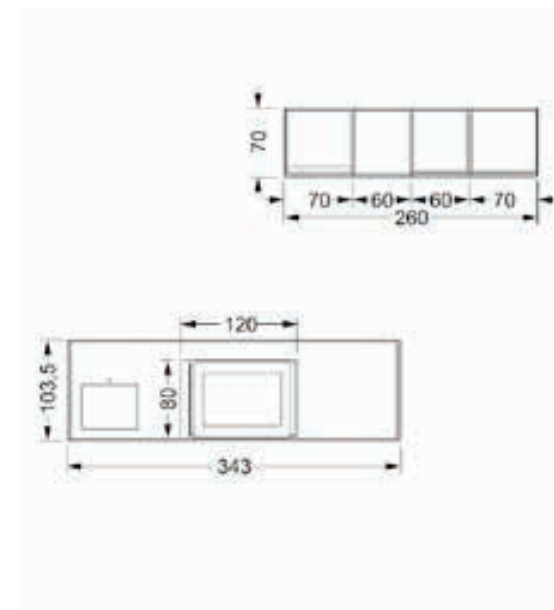
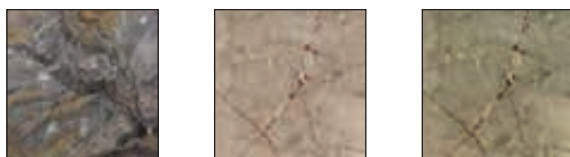

struttura esterna e ante • external structure and doors

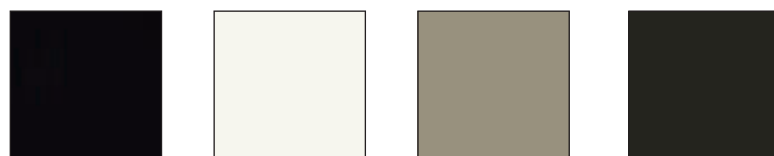

ripiani • shelves



zoccolo • base

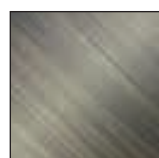

dettagli • details

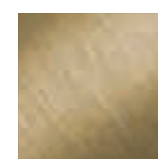

maniglie • handles

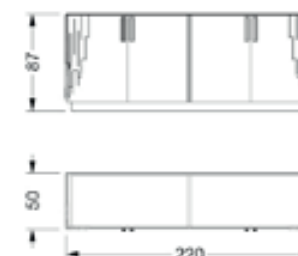



CASANOVA BUFFET

Disegno Reflex

Credenza con schienale in legno di cedro naturale e rivestimento esterno a specchio o in vetro verniciato. Possibilità di illuminazione LED per i decori. Decorì ad anello in vetro di Murano. Due ripiani in cedro all'interno. Apertura anta push-pull, con pendagli in vetro di Murano trasparente o con maniglie a lancia in vetro di Murano trasparenti o in tinta con i decori ad anello.

Sideboard with cedar wood back and external covering in mirror or in lacquered glass. LED lighting system available for the Murano glass rings decorations as option. Equipped with two shelves in cedar wood. Push-pull opening, with transparent Murano glass pendant handles or with Murano glass long handles in transparent or in the same colour as the ring decorations.



CASANOVA BUFFET LONG

Disegno Reflex

Credenza sagomata dotata di 2 ante in legno curvato. Maniglie disponibili in metallo lucidato o argento, oppure in vetro di Murano trasparente, a pendaglio o a lancia. Parti a giorno rivestite a specchio con ripiani in vetro sagomato. Cassetto interno. Struttura disponibile in laccato lucido colori di serie o Ebano lucido o opaco. Decorì in vetro di Murano trasparente o in vari colori o in oro.

Curved sideboard equipped with 2 doors in wood. Handles available in shiny lacquered metal or silver finish or in transparent Murano glass, in pendant or long handles shape. Open elements covered with mirror glass with curved glass shelves. Internal drawer. Structure available in shiny lacquered finish, standard colours, or in shiny or matt Ebony. Murano glass decorations in transparent or in various colors or in gold.





CASANOVA MADIA

Disegno Reflex

Madia con schiena in legno naturale di cedro e struttura esterna rivestita in vetro a specchio o verniciato. Decorazione ad anelli in vetro di Murano trasparente o in vari colori o in oro zecchino. Apertura ante push-pull, con pendagli in vetro di Murano trasparente o con maniglie in vetro di Murano trasparente o in abbinamento con i decori. Interno con ripiano in vetro, cassetto e illuminazione.

Cupboard with back in natural cedar wood with external covering in mirror or lacquered glass. Ring decorations in transparent, coloured or gold Murano glass. Push-pull opening, with transparent Murano glass pendant handles or with Murano glass long handles in transparent or in the same colour as the ring decorations. Equipped with glass shelf, drawer and lighting system.



anelli • rings



maniglie • handles



vetro rivestimento • glass covering



legno rivestimento • wood covering
(solo buffet long / only buffet long)



buffet

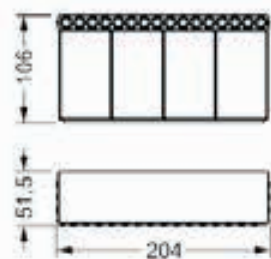

buffet long

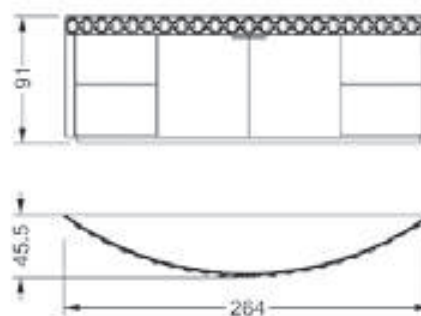

madia

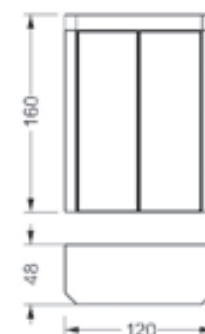

ZONA NOTTE / NIGHT AREA

CASANOVA ARMADIO

Disegno Reflex

Armadio componibile con struttura in legno, schiena in legno naturale di cedro e rivestimento esterno in vetro a specchio o verniciato. Decorazione ad anelli in vetro di Murano trasparente, oro o colorato. Apertura anta push-pull o con maniglie in vetro di Murano. Opzionale illuminazione interna, cassettiere e ripiani.

Modular wardrobe in wood with backs in natural cedar wood and external cover in mirror or lacquered glass. Top and bottom decoration with Murano glass ring transparent, gold or in colours. Doors with push-pull opening or with Murano glass handles. Optional internal lighting, drawers and shelves.





anelli • rings



maniglie • handles



vetro rivestimento • glass covering

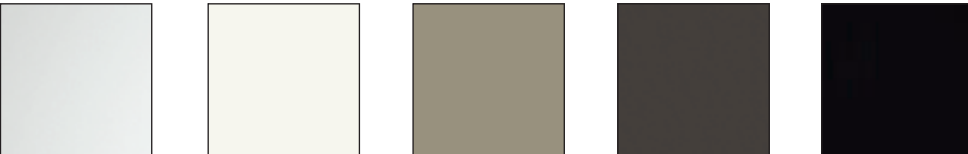

interno • interior

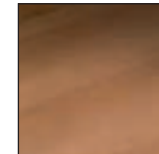

moduli • modules

ante e fianchi • doors and sides

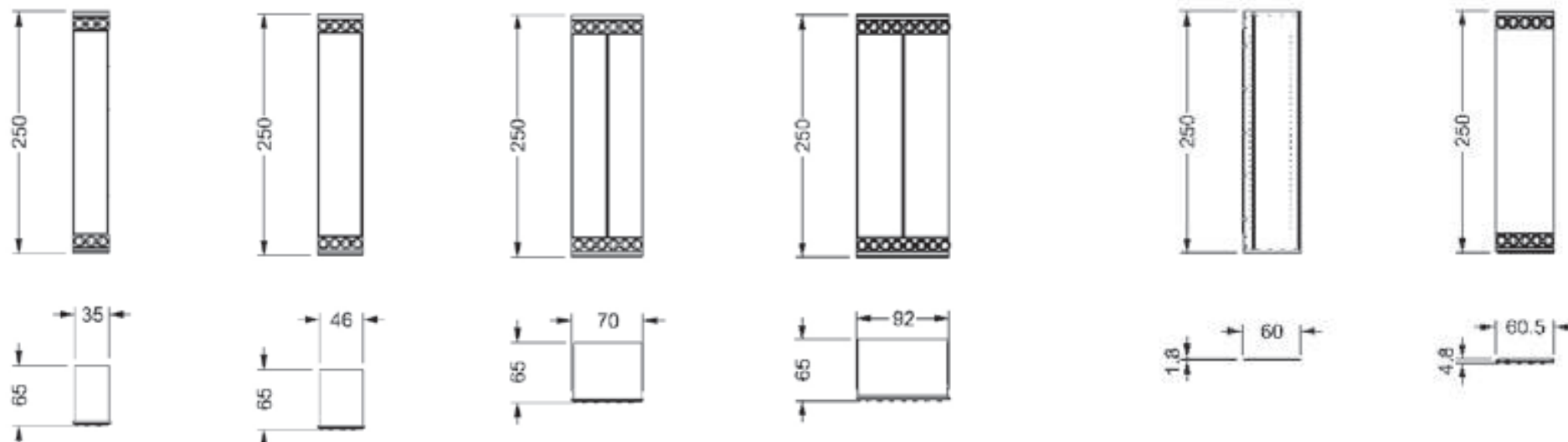

composizioni • compositions

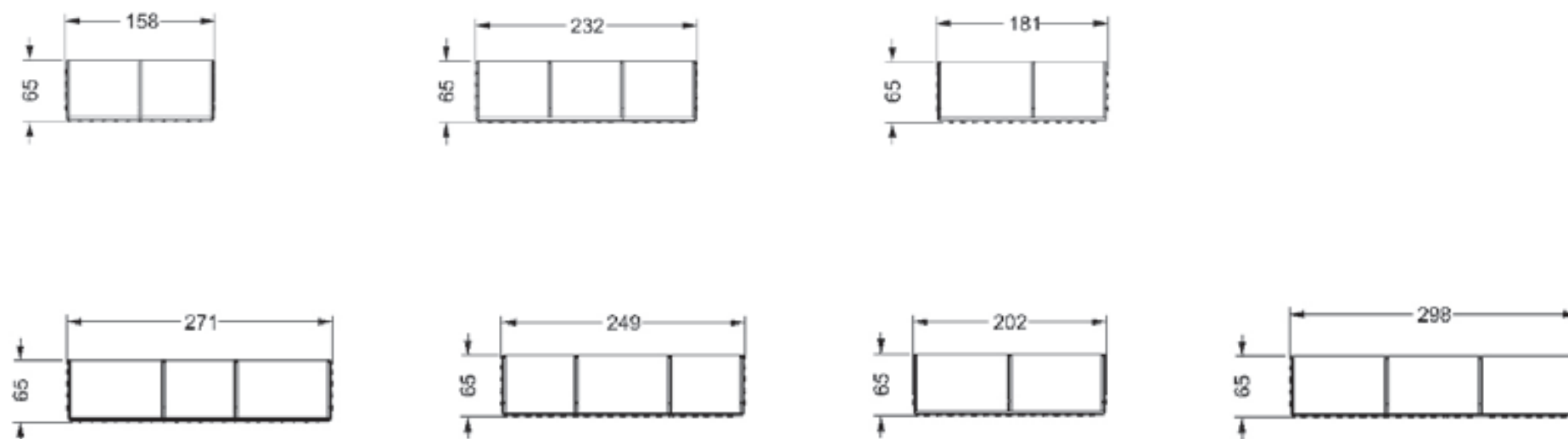

CASANOVA SPA

Disegno Reflex

Mobile bagno con gambe in vetro di Murano liscio o rigato con finitura lucida trasparente o in vari colori. Struttura in cristallo extrachiaro a specchio o in vetro verniciato, con applicazione di decori in vetro di Murano disponibili nella versione trasparente o colorato o nella versione finitura oro. Lavabi in vetro di Murano trasparente o oro. Opzionale: illuminazione a LED per i decori.

Bath furniture with Murano glass legs available in ribbed or smooth transparent glossy finish, or in various colours. Structure in extra clear mirror or lacquered glass. Decorations in handmade Murano glass, available in transparent or in the same colours as the legs or in gold finish. Wash basins in transparent Murano glass or in gold finish. Optional: LED lighting for the decorations.



MOBILI / FURNITURE

CASANOVA SPA

Disegno Reflex



decori • decorations



gambe • legs

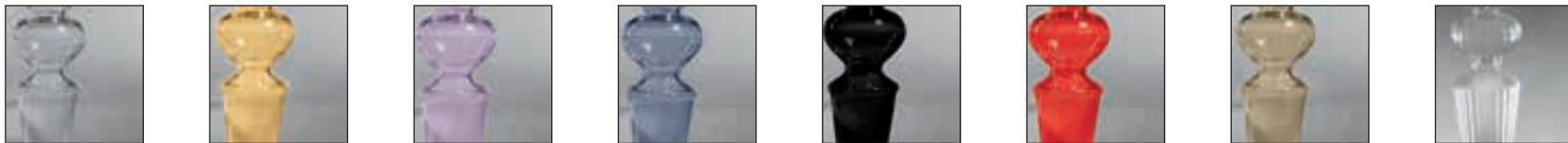

gold special

SCHEDA TECNICA • TECHNICAL DRAWINGS

lavabo • washbasin

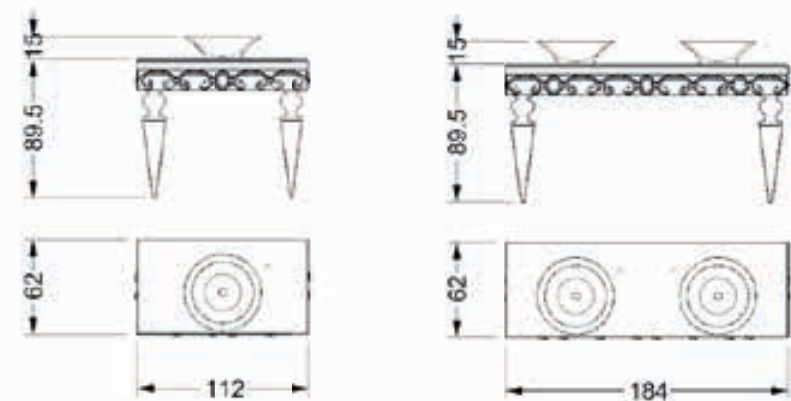

AVANTGARDE LIBRERIA

Disegno Reflex

Libreria modulare in legno laccato lucido con applicazioni in vetro bisellato verniciato sui frontali oppure in Ebano lucido. Schienale disponibile in vetro verniciato bianco, in Antique mirror, decoro San Marco o Vienna. Optional: illuminazione e ante in vetro trasparente o in legno in varie misure.

Modular bookcase in shiny lacquered wood with application of bevelled lacquered glass on the fronts or in shiny Ebony wood. Back available in white lacquered glass, in Antique mirror, in San Marco or Vienna pattern design glass. Optional: lighting system and doors in transparent glass or in wood.





MOBILI / FURNITURE

AVANTGARDE LIBRERIA

Disegno Reflex



struttura e ante • structure and doors



schiena • back

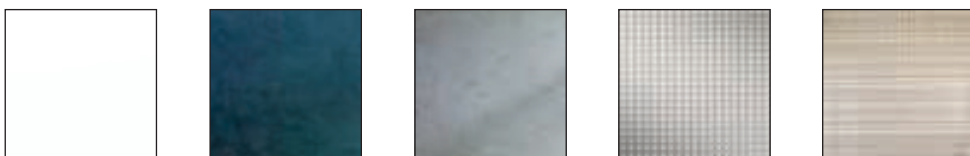

SCHEDA TECNICA • TECHNICAL DRAWINGS

moduli • modules

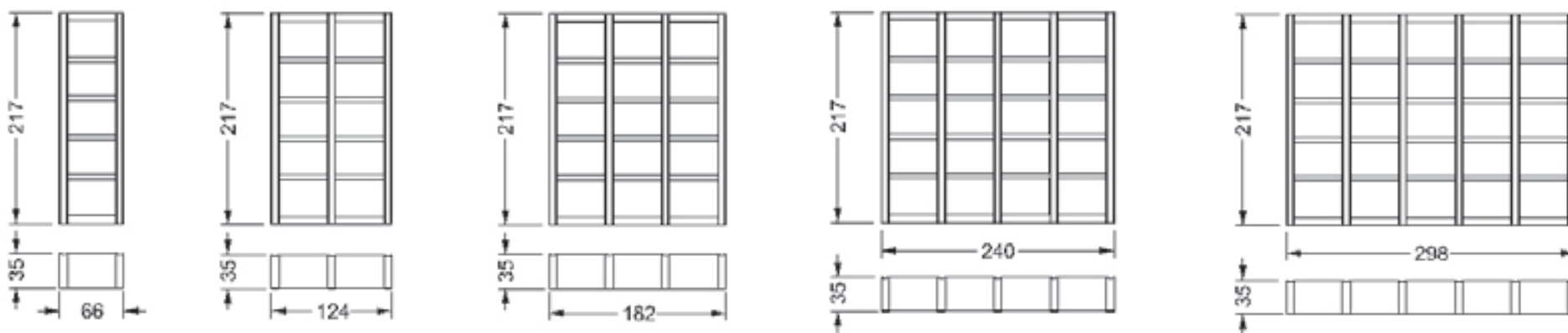

AVANTGARDE BAR e BAR SPECIAL

Disegno Reflex

Mobile bar composto da bancone in vetro extrachiario, bronzo o fumé bocciardato e satinato oppure con decoro Vienna. Pedana con piano di finitura in vetro verniciato, mobile a ripiani in legno laccato lucido con applicazione di vetro bisellato e verniciato sui frontali.

Bar unit composed by a bar counter in extra clear, bronze or smoked bush hammered and etched glass or in Vienna pattern glass. Platform with finishing top in lacquered glass and modular shelving unit in shiny lacquered wood with application of bevelled lacquered glass on the fronts.





struttura • structure

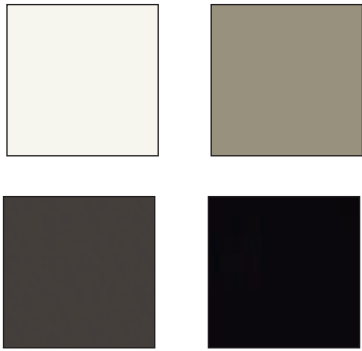

schienale • back



bancone vetro • glass bar counter

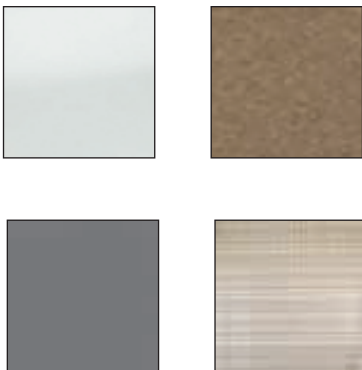

special

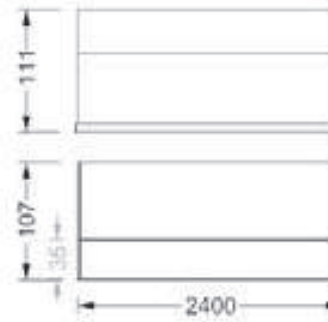
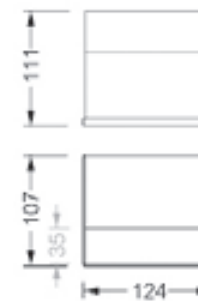
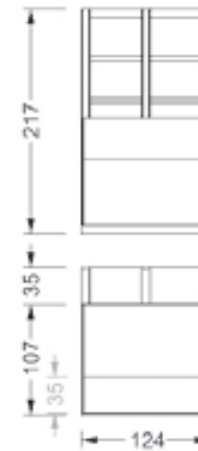
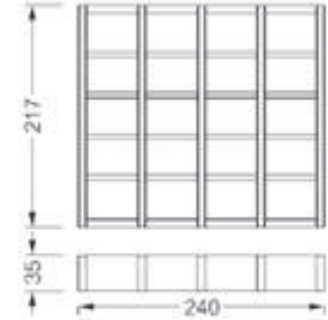
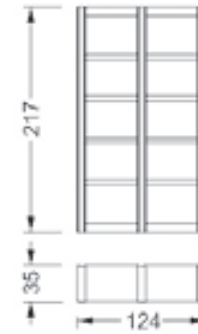
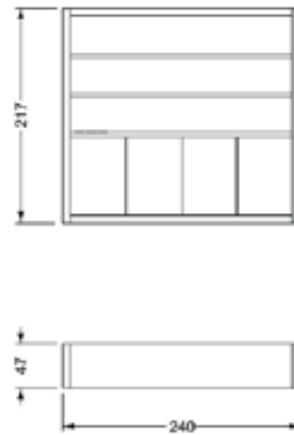

AVANTGARDE BAR COCKTAIL LUCE

Disegno Reflex

Mobile bar con due o tre ante a battente ed una anta a ribalta. Struttura in legno laccato lucido con applicazione di vetro bisellato e verniciato sui frontali, rivestita in specchio fumé oppure in Ebano laccato lucido. Ante rivestite in vetro verniciato bisellato liscio oppure con incisioni e pomoli in cristallo sfaccettato, o con incisione London. Illuminazione LED sotto al top e opzionale per interno del ripiano bar.

Bar cabinet with two or three hinged doors and one folding door. Structure in shiny lacquered wood with application of lacquered bevelled glass on the fronts, covered in smoked mirror glass or in shiny Ebony wood. Doors covered with bevelled lacquered glass, plain or with engravings and crystal handles, or with London engravings. LED lighting system under the top and optional inside the bar shelf.



struttura • structure

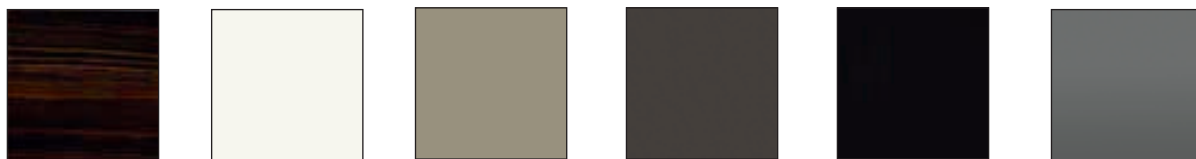

maniglie • handles



ante • doors

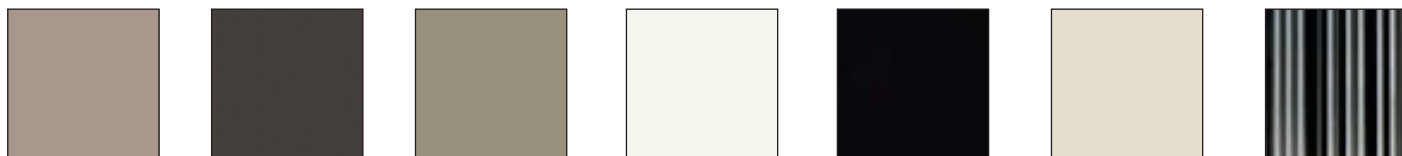

SCHEDA TECNICA • TECHNICAL DRAWINGS

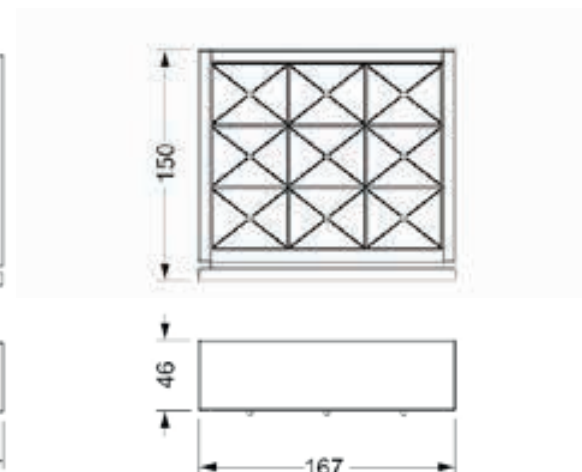
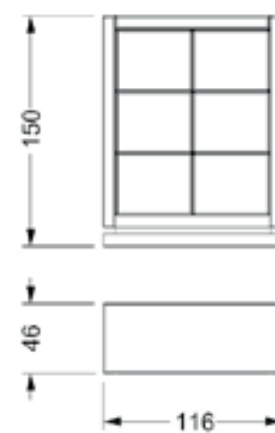



AVANTGARDE TV

Disegno Reflex

Mobile porta televisore con contenitore a doppia anta in legno laccato lucido rivestito in vetro verniciato e bisellato. Optional: ante con maniglie a pendaglio in vetro di Murano trasparente o con incisione e pomoli in cristallo, illuminazione a LED.

Tv-Stand with double door storage in shiny lacquered wood covered in lacquered bevelled glass. Optional: doors with pendant handles in transparent Murano glass or with engravings and round crystal handles, LED lighting.



AVANTGARDE LIBRERIA 150

Disegno Reflex

Libreria modulare in legno laccato lucido con applicazioni in vetro bisellato verniciato sui frontali oppure in ebano lucido. Schienale disponibile in vetro verniciato bianco, in Antique mirror o in vetro decoro San Marco o Vienna. Optional: illuminazione e ante in legno con apertura a ribalta.

Modular bookcase in shiny lacquered wood with application of bevelled lacquered glass on the fronts or in shiny ebony. Back available in white lacquered glass, in Antique mirror or in San Marco or Vienna pattern design glass. Lighting system and folding doors in wood as option.





struttura • structure



maniglie • handles

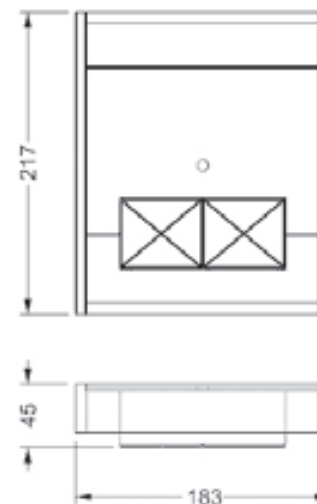

struttura e ante • structure and doors



schienale • back

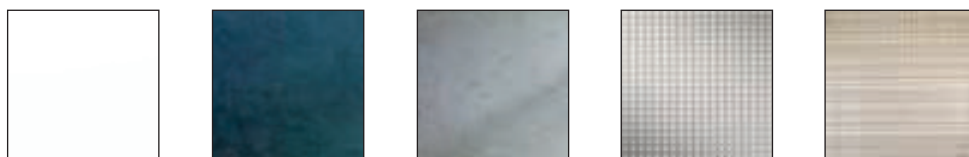

AVANTGARDE LIBRERIA COMPOSIZIONE

Disegno Reflex

Esempi di composizioni con elementi Avantgarde libreria. Struttura disponibile in legno laccato lucido con applicazioni in vetro bisellato verniciato oppure in ebano lucido. Disponibili varie opzioni per le schiene e per le dimensioni delle ante.

Examples of compositions with Avantgarde libreria modules. Structure available in shiny lacquered wood with applications of bevelled lacquered glass on the fronts or in ebony wood. Various options available for the backs and for the door sizes.





struttura e ante • structure and doors



schienale • back

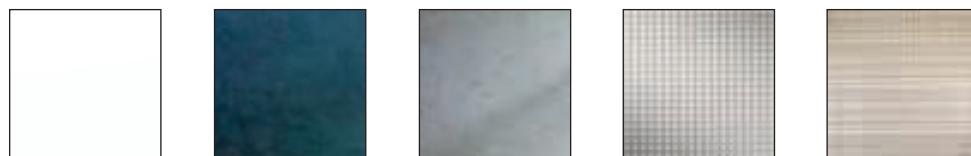

SCHEDA TECNICA • TECHNICAL DRAWINGS

moduli • modules

Modulo 150 - 50 -150

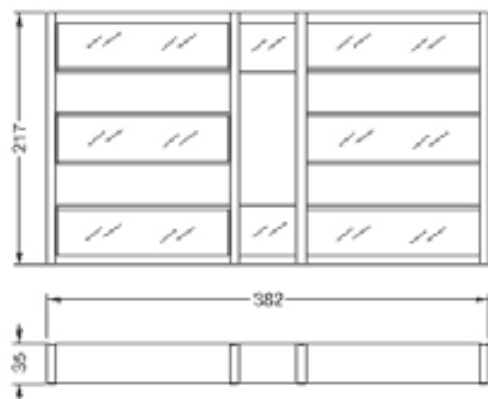

Modulo 50 - 150 - 50 -150 - 50

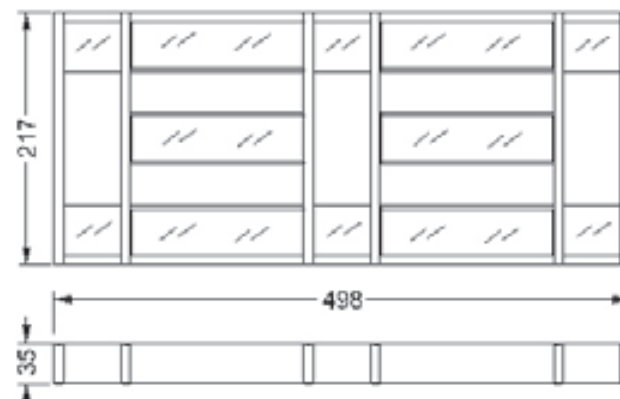

AVANTGARDE LIBRERIA SPECIAL

Disegno Reflex

Libreria con struttura in Ebanò lucido con applicazioni frontali in vetro specchio fumè bisellato. Due elementi con ripiani a giorno, schiena e due ante H40 cm in Ebanò lucido. Modulo centrale con due ante con incisioni London e schiena in vetro verniciato bianco. Ripiani interni in vetro e illuminazione LED.

Bookcase with structure in shiny Ebony wood with frontal bevelled smoked mirror glass applications. Two open side elements with shelves, back and two doors H40 cm in shiny Ebony. Central module with two hinged door with London engravings and back in white lacquered glass. Internal glass shelves and LED lighting.



AVANTGARDE CREDENZA LOW

Disegno Reflex

Credenza in legno laccato lucido rivestito in vetro verniciato bisellato nei colori di serie, o in vetro a specchio fumé. Disponibile con apertura push-pull o con maniglie a pendaglio in vetro di Murano trasparente o con incisioni e pomoli in cristallo sfaccettato.

Sideboard in shiny lacquered wood covered in the standard colours painted glass with bevel or in smoked mirror glass. Available with pushpull opening, or with pendant handles in transparent Murano glass or with engravings and round crystal handles.



struttura e frontali • structure and fronts

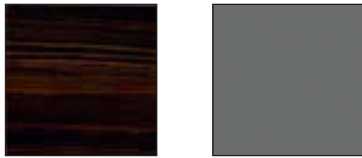

anta • doors



schienale • back



Avantgarde libreria special

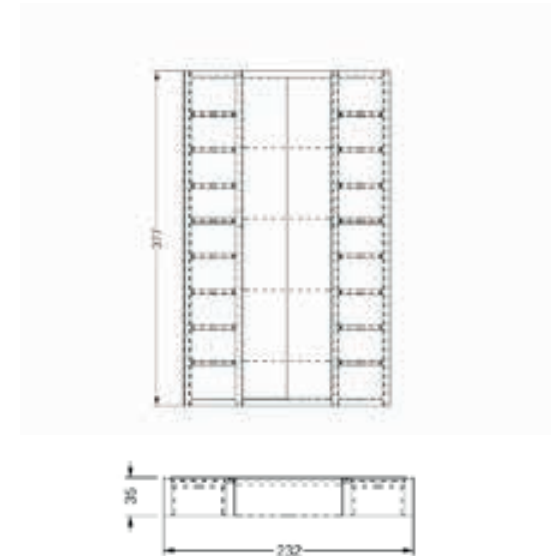

Struttura e ante • Structure and doors

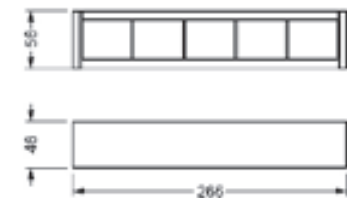
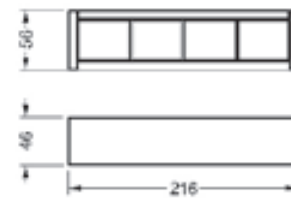

maniglie • handles



vetro • glass

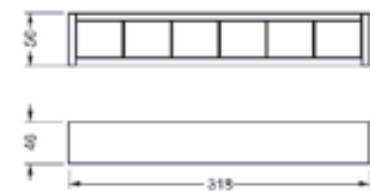

AVANTGARDE MADIA

Disegno Reflex

Madia in legno laccato lucido rivestito in vetro con vani interni in legno laccato lucido con cassetto in tinta con illuminazione. Ante apertura push-pull o con incisioni e pomoli in cristallo sfaccettato. Optional: cassetto interno e schienale laccato rosso lucido.

Cupboard in shiny lacquered wood covered in glass with inner spaces in shiny lacquered wood and internal drawer in the same colour with lighting. Doors with push-pull opening or with engravings and round crystal handles. Optional: internal drawer and back shiny lacquered red colour.





AVANTGARDE BUFFET

Disegno Reflex

Buffet con struttura in legno laccato lucido con applicazioni di vetro bisellato verniciato su frontali e top. Schienale in legno laccato bianco opaco. Ante rivestite in vetro verniciato bisellato liscio con apertura push-pull, con maniglie a pendaglio in vetro di Murano oppure con incisioni e pomoli in cristallo sfaccettato. Illuminazione opzionale.

Buffet in shiny lacquered wood with applications of bevelled lacquered glass on the fronts and top. Back in matt white lacquered wood. Doors covered with bevelled lacquered glass plain with push-pull opening, with pendant Murano glass handles or with engravings and round crystal handles. Lighting system as option.





struttura e ante • structure and doors



cassetto e schienale opzionale • optional drawer and back

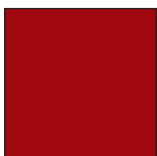

maniglie • handles

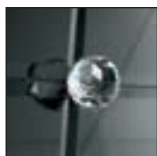

120

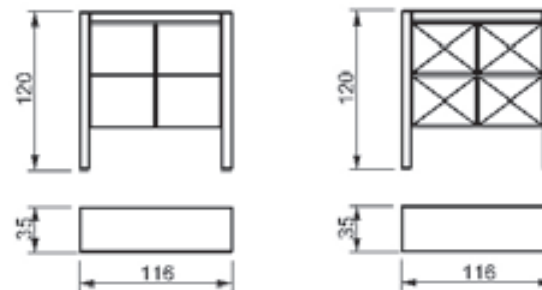

160

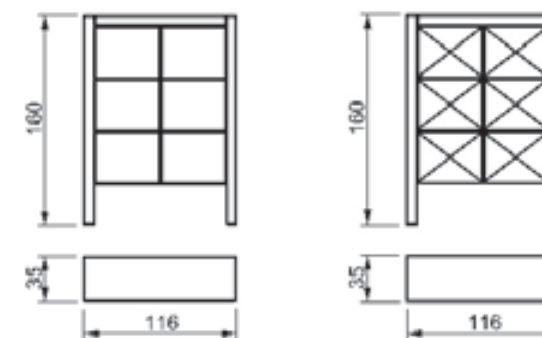

struttura e ante • structure and doors

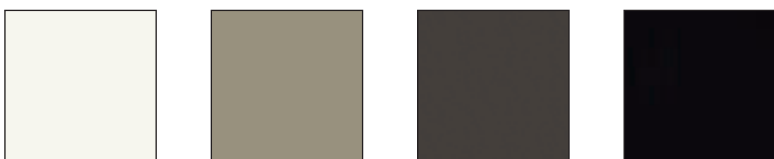

maniglie • handles

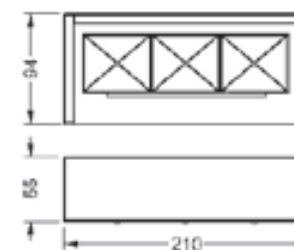
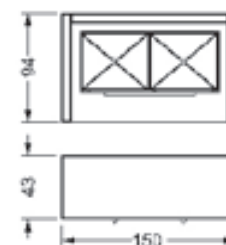

MOBILI / FURNITURE

AVANTGARDE CREDENZA LUCE

Disegno Reflex

Credenza con struttura in legno laccato lucido con applicazione di vetro bisellato verniciato su frontali e top oppure in ebano lucido. Ante rivestite in vetro bisellato verniciato oppure in Antique mirror. Apertura push-pull oppure con pomolo in cristallo sfaccettato, oppure maniglia a pendente o maniglia ad arco in vetro di Murano. Illuminazione a Led sotto al top.

Sideboard in shiny lacquered wood with application of bevelled lacquered glass on fronts and top or in shiny ebony. Doors covered with bevelled lacquered glass or with Antique mirror. Push-pull opening or with round crystal handles or pendant or arched Murano glass handles. Led lighting system under the top.







struttura • structure



ante • doors

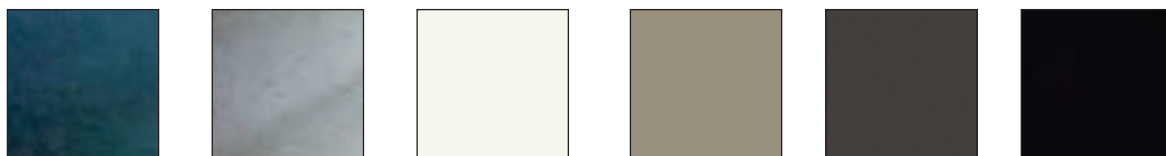

maniglie • handles



SCHEDA TECNICA • TECHNICAL DRAWINGS

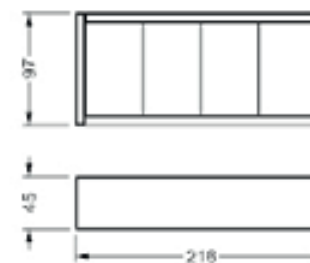
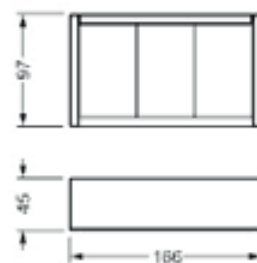
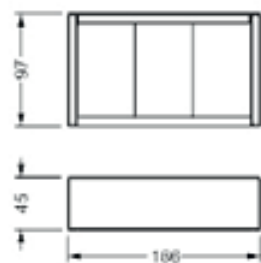

AVANTGARDE TOILETTE

Disegno Reflex

Scrivania/toilette in legno laccato lucido con applicazione di vetro bisellato verniciato su frontali e top. Dotato di 2 cassetti e antina a ribalta centrale con specchio interno con possibilità di illuminazione LED. Disponibili pomoli in cristallo sfaccettato o maniglie a pendente in vetro di Murano.

Desk/toilette in shiny lacquered wood with application of bevelled lacquered glass on fronts and top. Equipped with two drawers and one folding door with inside mirror and with optional LED lighting system. Available round crystal handles or pendant Murano glass handles.



AVANTGARDE SPA

Disegno Reflex

Mobile bagno in legno laccato lucido con applicazioni in vetro bisellato verniciato su frontali e top. Dotato di 2 ante e 3 cassetti con frontali rivestiti in vetro bisellato verniciato liscio oppure con incisioni e pomoli in cristallo sfaccettato oppure maniglie a pendente in vetro di Murano. Lavabo in vetro di Murano trasparente.

Bathroom console in shiny lacquered wood with application of bevelled lacquered glass on fronts and top. Two doors and 3 drawers covered with bevelled lacquered glass, plain or with engravings and round crystal handles or with pendant Murano glass handles. Wash basin in transparent Murano glass.



struttura • structure

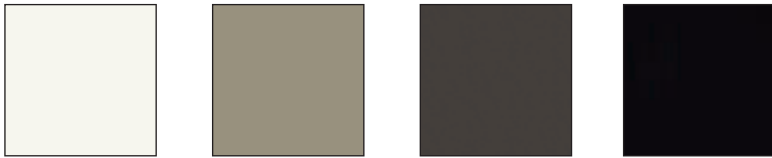

maniglie • handles

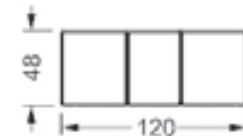
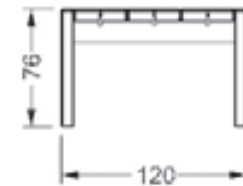

struttura e cassetti • structure and drawers



maniglie • handles



schienale • back

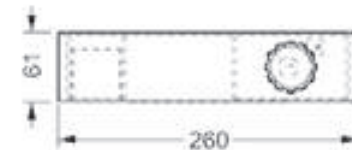
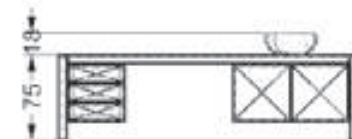

DUNE COLLEZIONE

Disegno Riccardo Lucatello

Collezione di mobili in legno laccato lucido con applicazione di vetro bisellato verniciato sui frontali oppure in ebano lucido. Libreria modulare caratterizzata da schienali in vetro decoro Dune. Credenza e elementi H.140 con ante rivestite in vetro decoro Dune.

Collection of cabinets in shiny lacquered wood with application of bevelled lacquered glass on the fronts or in shiny Ebony. Modular bookcase characterized by backs in Dune pattern design glass. Sideboard and H.140 elements with doors covered with Dune pattern design glass.



MOBILI / FURNITURE

DUNE CREDENZA LUCE

Disegno Riccardo Lucatello





struttura • structure

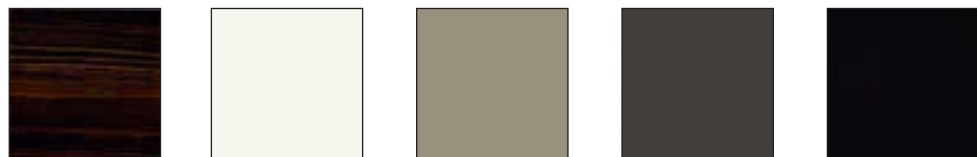

schienale e ante • back and doors

maniglie • handles

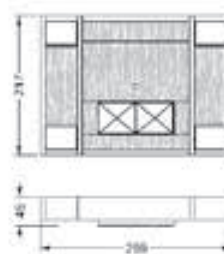
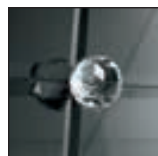
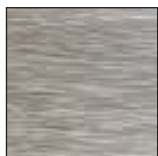

struttura • structure

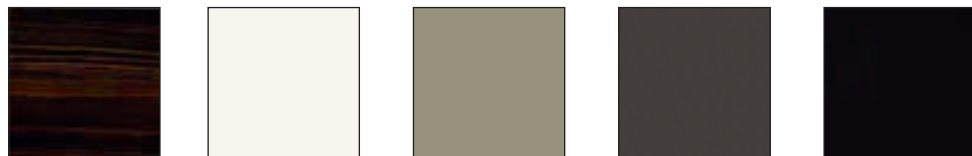

ante • doors

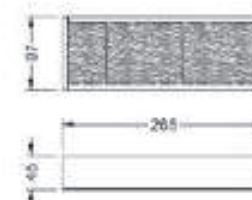
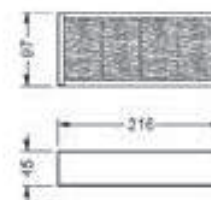
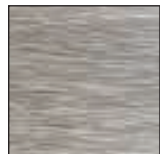

DIAMANTE MADIA

Disegno Reflex

Madia modulare in legno laccato lucido con anta in vetro con incisioni Diamante con sezione centrale trasparente e vano interno a vista in foglia oro.

Versione in laccato lucido nero beluga con frontali in vetro specchio fumé e vano interno a vista rivestito a specchio. Con illuminazione a LED.

Modular cabinet in shiny lacquered wood with glass door with Diamante engravings with transparent central section and central space in gold leaf.

Version in shiny nero beluga lacquered finish with application of bevelled smoked mirror glass and central space in mirror. With LED lighting.





DIAMANTE BUFFET

Disegno Reflex

Buffet in legno laccato lucido nero beluga rivestito in vetro specchio fumé bisellato. Elemento contenitore con alta a ribalta rivestita in vetro specchio fumé con incisioni Diamante. Illuminazione a LED.

Sideboard in shiny nero beluga lacquered finish with external cover in bevelled smoked mirror glass. Storage unit with folding door covered in smoked mirror glass with Diamante engravings. LED lighting system.



struttura e rivestimento • structure and covering

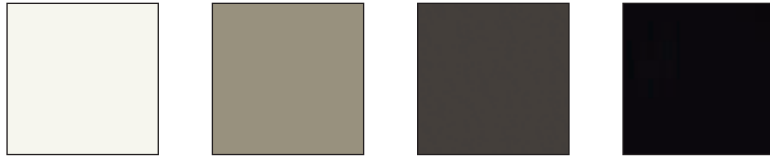

vano • central space

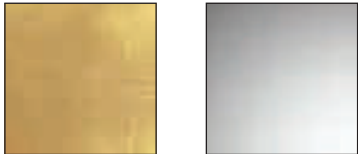

ante • doors

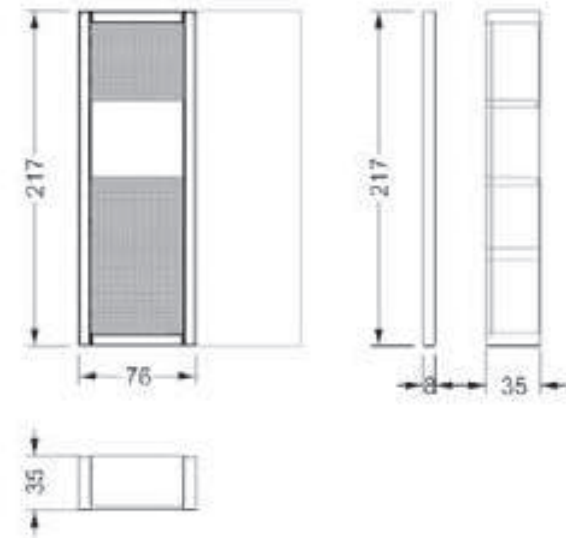
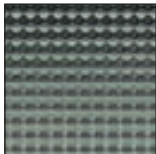

rivestimento • covering



ante • doors

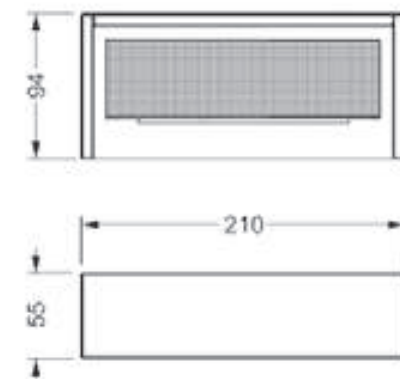
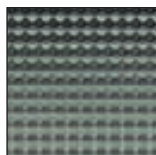

CA' D'ORO BUFFET

Disegno Reflex

Buffet con struttura in legno Ebano lucido o laccato lucido. Ante in vetro con decoro Dune, Vienna o San Marco con profilo in metallo e illuminazione LED. Basamento in vetro in abbinamento con le ante. Distanziatori e maniglia in metallo.

Sideboard with wooden structure in shiny Ebony or shiny lacquered finish. Doors in glass with Dune, Vienna or San Marco pattern design with metal frame and LED lighting system. Legs with pattern design matching the doors. Metal spacers and handles.



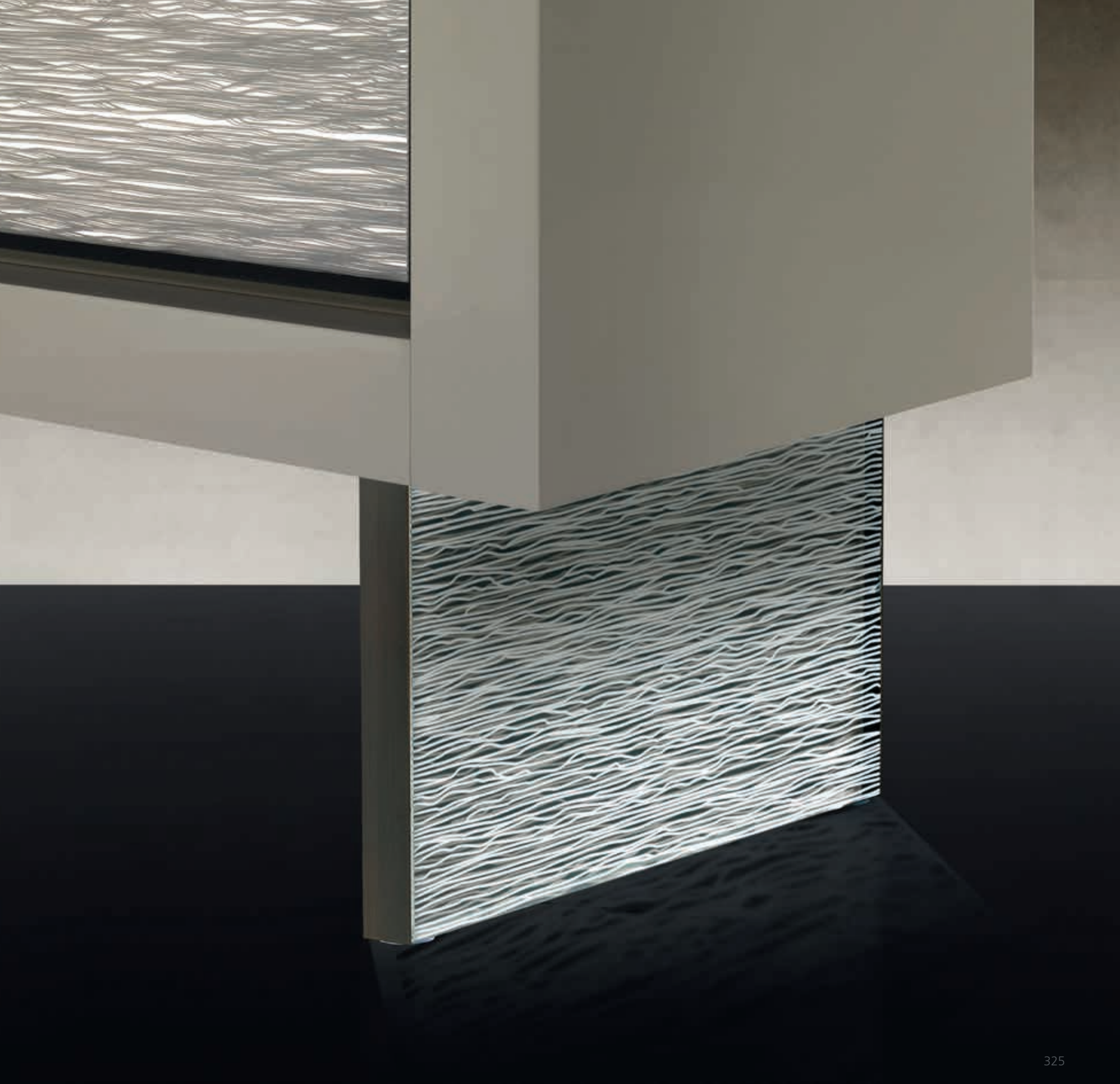

CA' D'ORO MADIA BASSA

Disegno Reflex

Madia con struttura in legno Ebano lucido o laccato lucido. Ante in vetro con decoro Dune , Vienna o San Marco con profilo in metallo e illuminazione LED. Basamento in vetro in abbinamento con le ante. Distanziatori e maniglia in metallo.

Cupboard with wooden structure in shiny Ebony or shiny lacquered finish. Doors in glass with Dune, Vienna or San Marco pattern design with metal frame and LED lighting system. Legs with pattern design matching the doors. Metal spacers and handles.

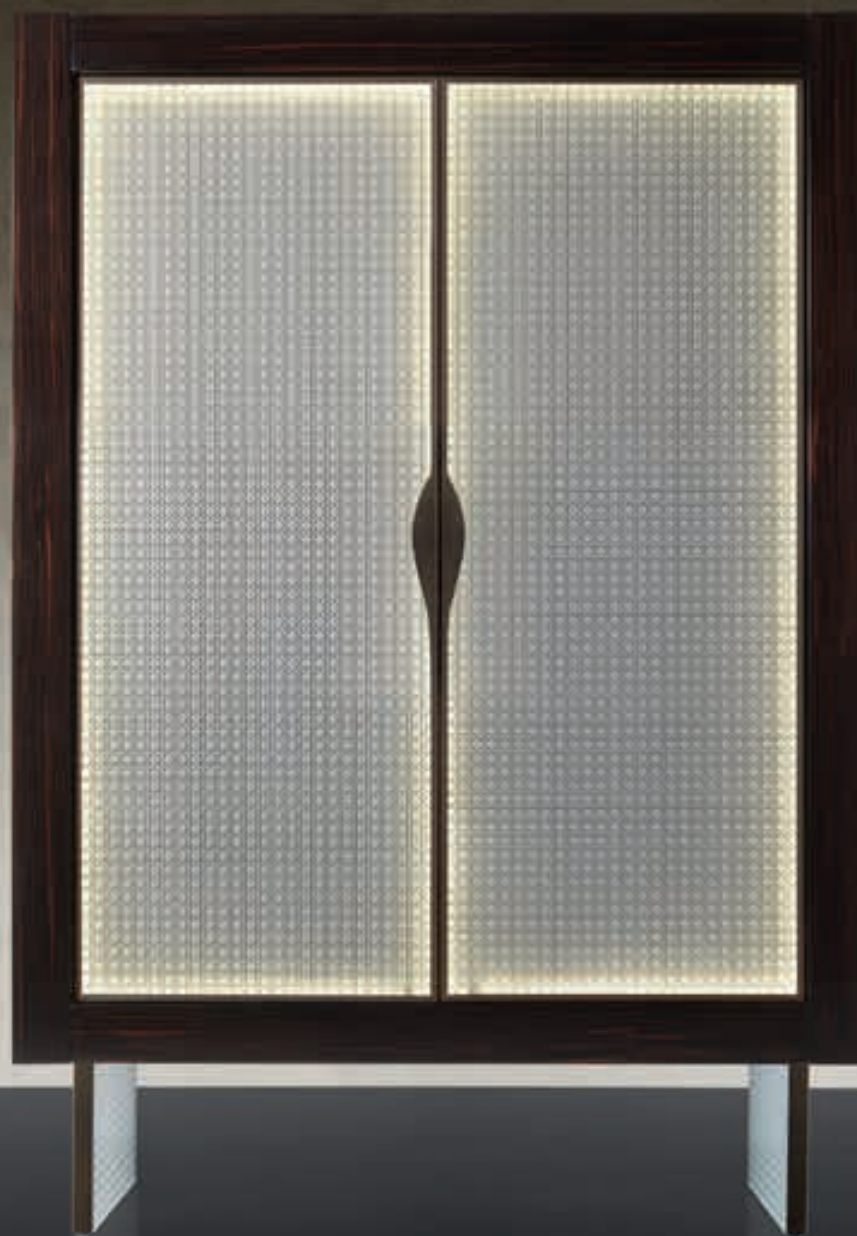

CA' D'ORO MADIA ALTA

Disegno Reflex

Madia con struttura in legno Ebano lucido o laccato lucido. Ante in vetro con decoro Dune , Vienna o San Marco con profilo in metallo e illuminazione LED. Basamento in vetro in abbinamento con le ante. Distanziatori e maniglia in metallo.

Cupboard with wooden structure in shiny Ebony or shiny lacquered finish. Doors in glass with Dune, Vienna or San Marco pattern design with metal frame and LED lighting system. Legs with pattern design matching the doors. Metal spacers and handles.

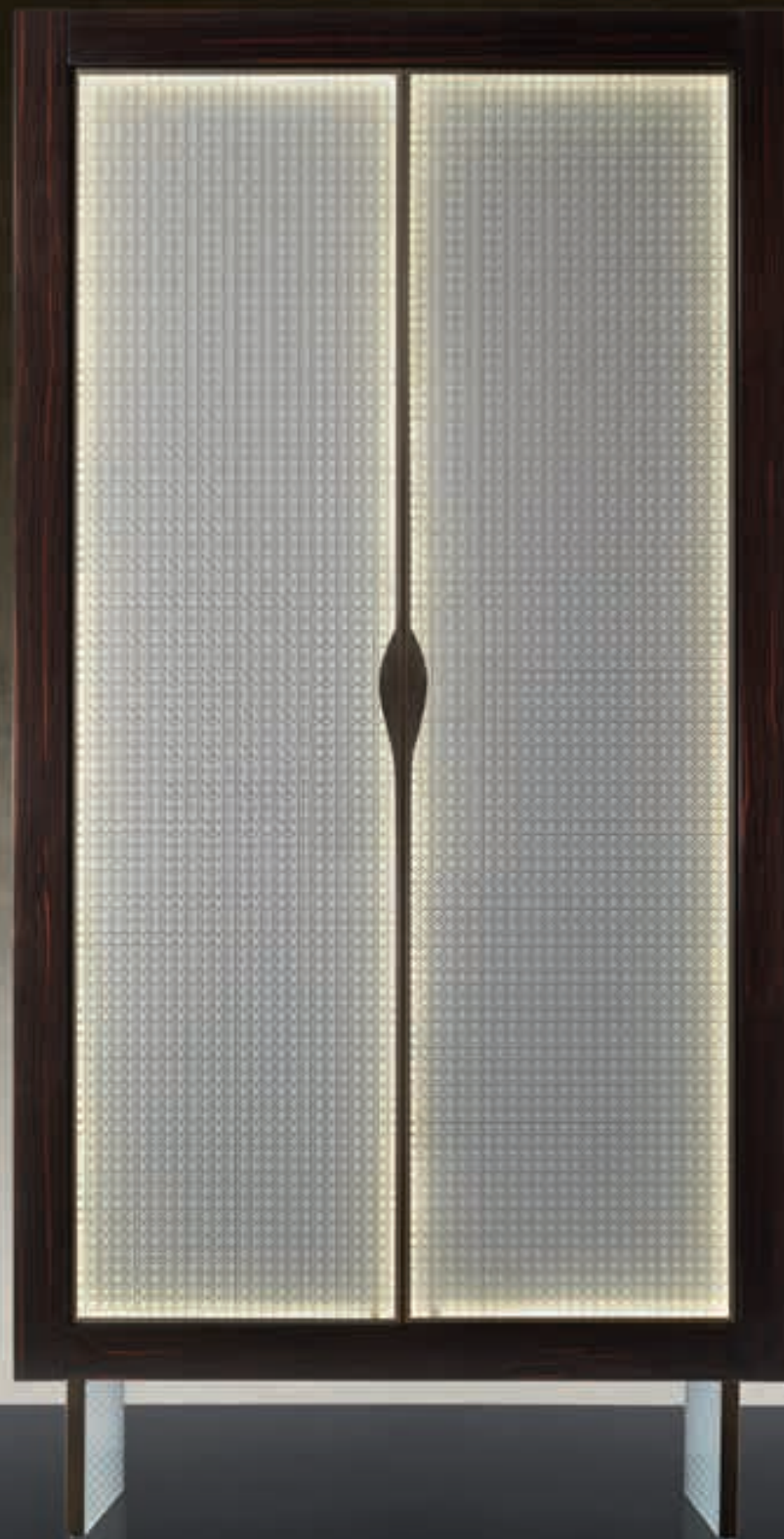

struttura • structure

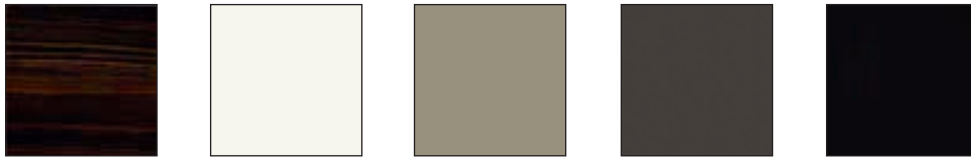

base e ante • base and doors

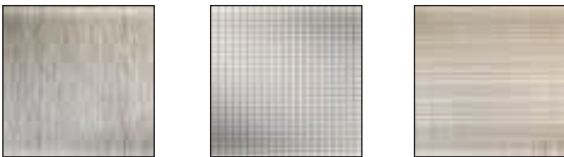

maniglia • handle

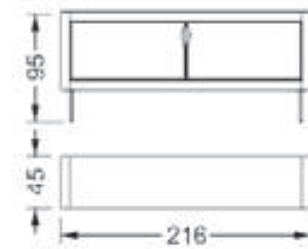
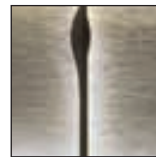

struttura • structure

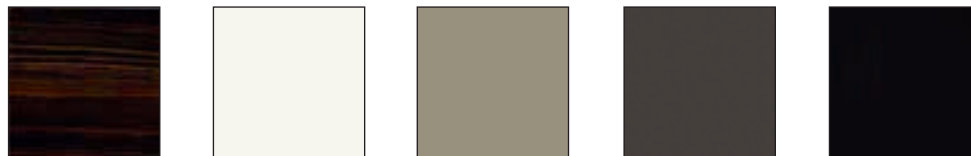

base e ante • base and doors

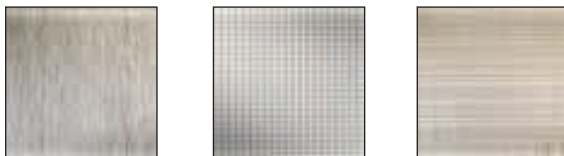

maniglia • handle

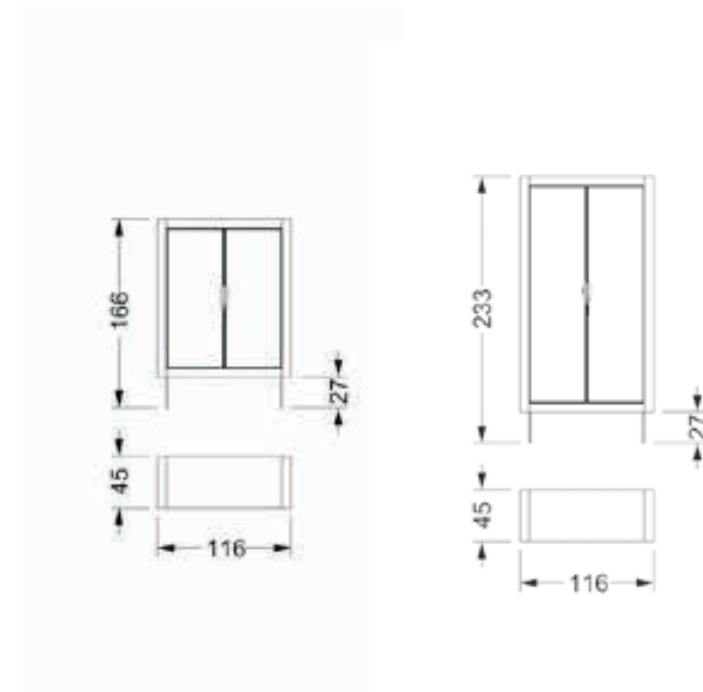

MURANO MADIA e BUFFET

Disegno Reflex

Madia e buffet in legno laccato lucido o in Ebano lucido. Anta centrale scorrevole con inserto in vetro di Murano. Due ante laterali a battente per il buffet e vani a giorno con ripiani in vetro per la madia. Illuminazione interna. Piedi in acciaio inox.

Cupboard and sideboard in shiny lacquered wood or in shiny Ebony. Central sliding door with coloured Murano glass disc. Two side doors for the sideboard and two open sides with glass shelves for the cupboard. Internal lighting system. Legs in stainless steel.





MOBILI / FURNITURE

GONDOLA BUFFET

Disegno Reflex

Buffet in ebano laccato lucido. Cassetto con frontale in vetro extrachiario bocciardato. Ripiani interni in cristallo.

Buffet in ebony-wood, shiny lacquered. Central drawer front in extra clear bush-hammered glass. Side parts with inner glass shelves.



OCCHIO BUFFET

Disegno Riccardo Lucatello

Buffet in Ebanò laccato lucido con ante e schienale curvati. Maniglie e angolari in metallo lucidato oppure in argento martellato. Ripiani interni in cristallo.

Buffet in shiny Ebony wood with curved doors and back. Handles and angle bars in shiny metal or in hammered silver. Inner glass shelves.



struttura • structure

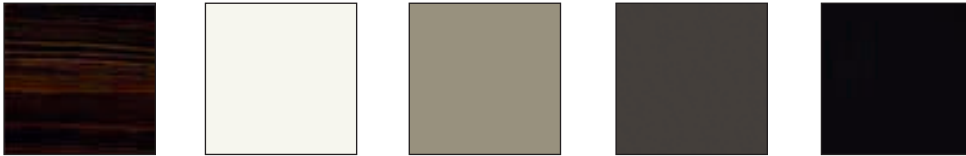

inserto • disc

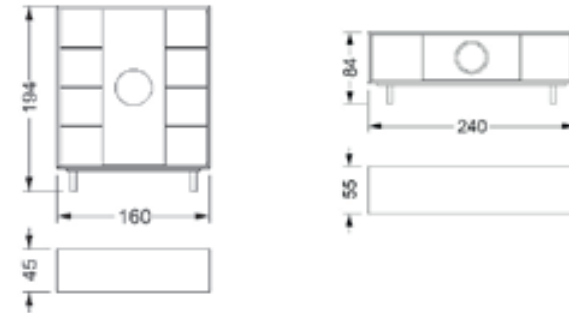

GONDOLA BUFFET

FINITURE • FINISHES

SCHEMA TECNICA • TECHNICAL DRAWINGS

struttura • structure



frontale cassetto • drawer's front

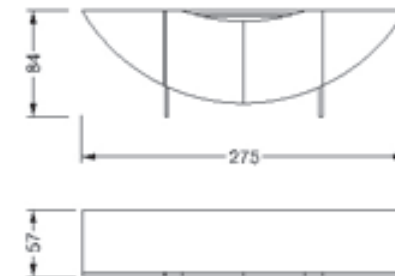

OCCHIO BUFFET

FINITURE • FINISHES

SCHEMA TECNICA • TECHNICAL DRAWINGS

struttura • structure



angolari e maniglie • sides and handles

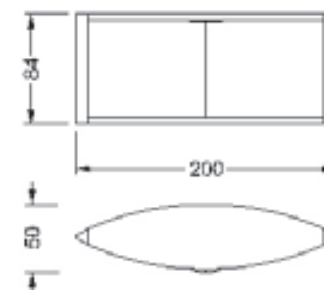

GIANO MODULARE

Disegno Reflex

Elemento modulare nelle versioni a giorno con schiena in vetro sabbato oppure chiuso con ante in vetro trasparente o in legno. Disponibile in Noce Canaletto, Ebano lucido o laccato opaco. Maniglie e profili in acciaio satinato o in argento.

Modular element in open version with frosted glass back or closed with doors in transparent glass or in wood. Available in Canaletto walnut, shiny Ebony wood or matt lacquered finish. Handles and joints in glazed steel or in silver.



GIANO BUFFET

Disegno Arnaldo Gamba e Leila Guerra

Buffet in legno con un'anta a ribalta e un cassetto. Disponibile nelle finiture laccato lucido, in Ebano lucido o Noce Canaletto. Illuminazione a LED. Fianchi e top in cristallo trasparente o in vetro bocciardato extra-chiaro, bronzo o fumé.

Buffet in wood with one folding door and one drawer. Available in different finishes: shiny lacquered, in shiny Ebony or in Canaletto walnut. Equipped with LED lighting. Sides and top in clear or in extra clear, bronze or smoked bush-hammered glass.



struttura • structure

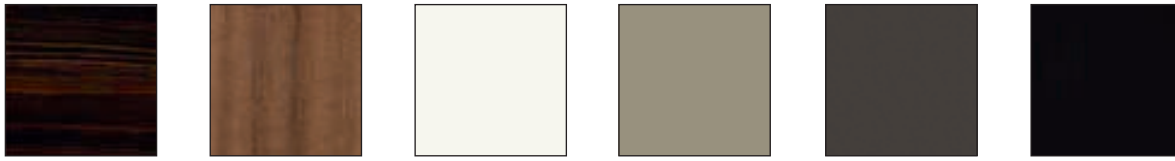

base e ante • base and doors

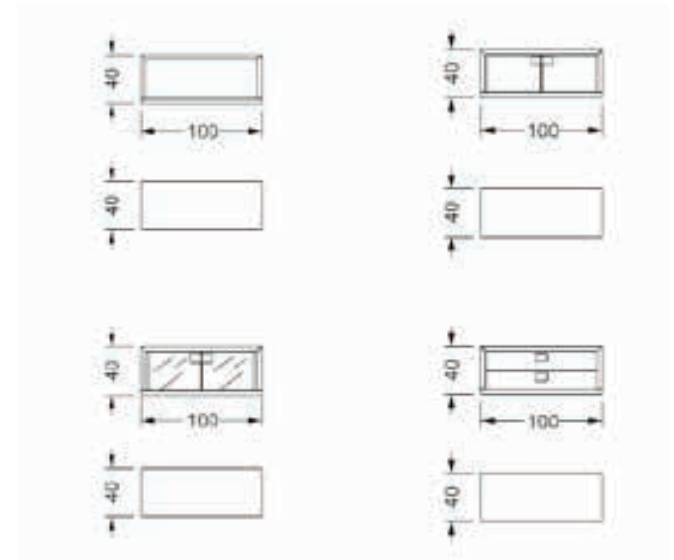
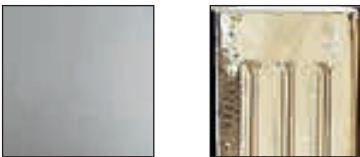

struttura • structure

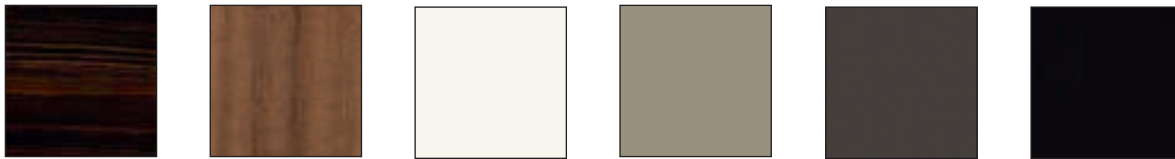

top e fianchi • sides and top (solo per buffet / only for buffet)

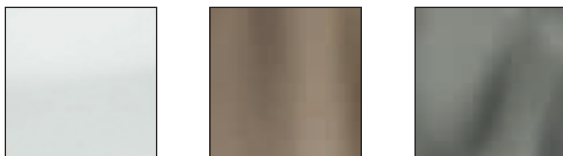

buffet

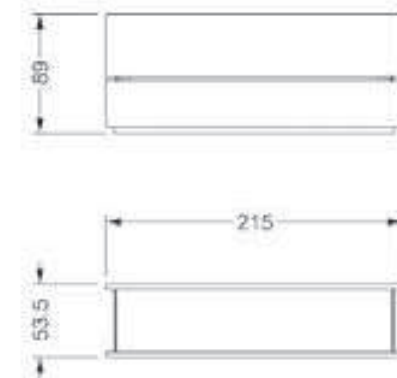

MIRAGE TV

Disegno Reflex

Mirage è una nuova soluzione d'arredo, pensata ed ottimizzata per televisori LED, LCD e Plasma, in cui la distribuzione degli spazi interni permette l'ancoraggio di televisori di varie marche e dimensioni mediante supporti scorrevoli, stabili e sicuri. L'ergonomica distribuzione degli spazi interni, consente di alloggiare componenti video audio surround con una diffusione del suono a 360°, in cui il mobile stesso funge da cassa di risonanza migliorando la qualità dei suoni bassi. Mirage permette inoltre di ospitare interi sistemi media center, come PS3, Xbox, DVD, VRC e woofer. La struttura in alluminio poggia su una base girevole in acciaio satinato con anta in vetro dark-grey serigrafata nera e schienale a specchio.

Mirage is a new furnishing solution for LED, LCD and Plasma televisions; a perfect distribution of the inner spaces allows an excellent fitting of TVs belonging to different brands and with different sizes, thanks to its sliding, steady and safe supports. It is possible to install video/audio systems with a 360° sound diffusion; the unit itself is a soundbox that improves the quality of the bass sounds. Moreover, with Mirage you can install media-center systems such as PS3, XBOX, DVD, VRC and woofers. The aluminium structure is placed on a turning base in brushed steel and it's fitted with mirror back and with door in dark-grey glass with black serigraphy.

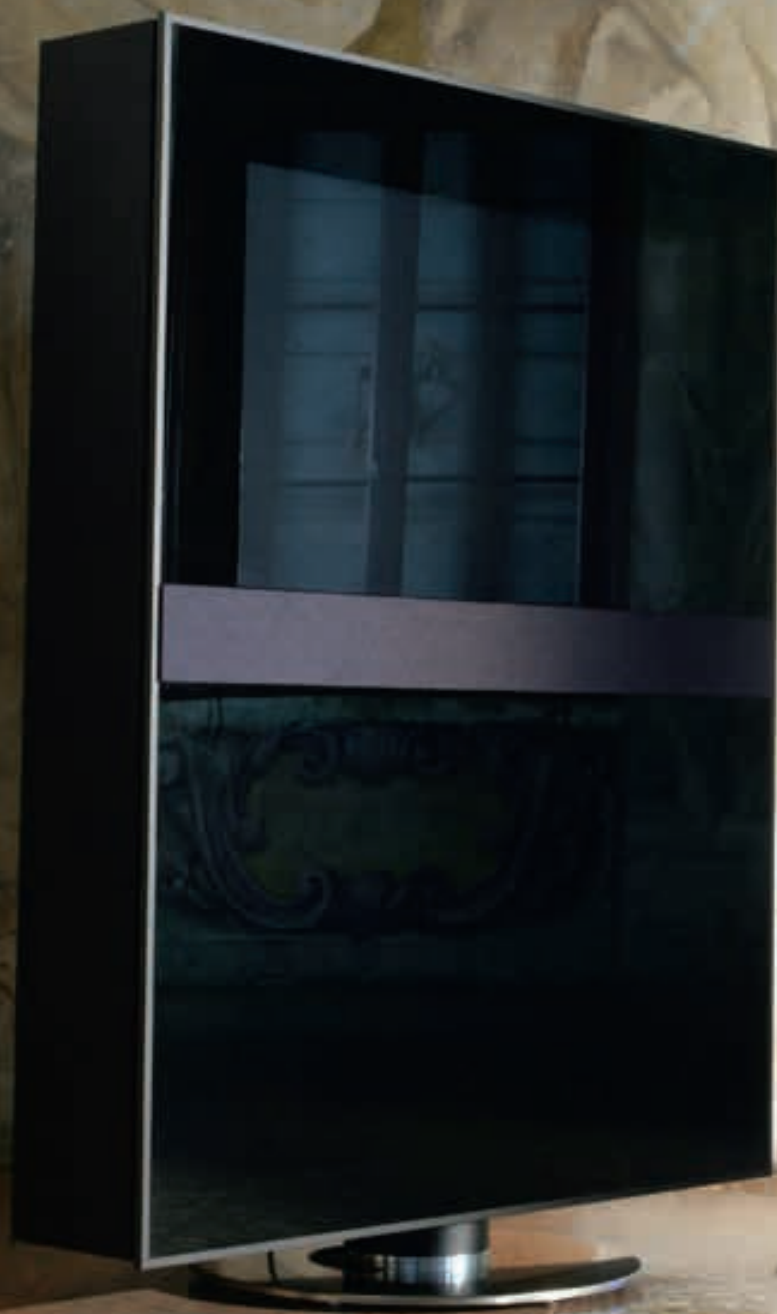



ONIS VETRINE

Disegno Tulczinsky

Collezione di vetrine interamente in cristallo extrachiaro con piedini regolabili in metallo satinato oppure con piastra in metallo satinato e supporto centrale. Versione rettangolare con decorazione 'Tree' Impianto luce a 5 faretti dicroici e dimmer opzionale.

Collection of cabinets in extraclear glass with adjustable glazed metal feet or with glazed metal base with central support. Rectangular version also with 'Tree' decoration. Lighting system with 5 dichroic spotlights and dimmer as option.



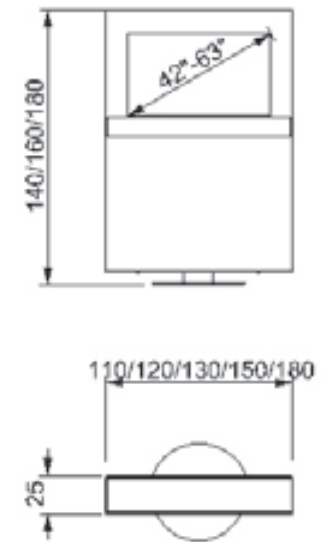

struttura • structure

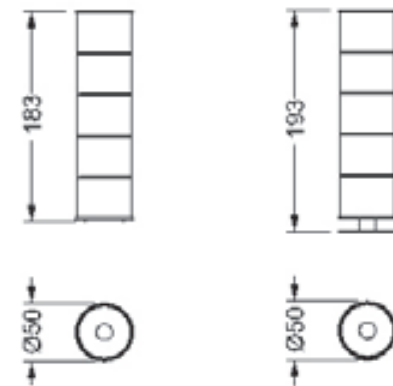

reflex
GLAMOUR

SPECCHI
M I R R O R S

347	<i>BOHEME specchio</i>
348	<i>CA' D'ORO specchio</i>
342	<i>CASANOVA specchio</i>
350	<i>DIAMANTE specchio tv</i>
356	<i>FIOCCO specchio</i>
360	<i>GALASSIA specchio</i>
340	<i>IMPACT specchio</i>
354	<i>PRISMA specchio</i>
355	<i>PRISMA specchio tv</i>
351	<i>TITANIUM specchio</i>
358	<i>VENEZIA specchio</i>

IMPACT SPECCHIO

Disegno Reflex

Specchio con cornice in acciaio super-mirror. Specchio centrale disponibile in varie misure.

Mirror with frame in super-mirror steel. Central mirror available in different sizes.



struttura • structure

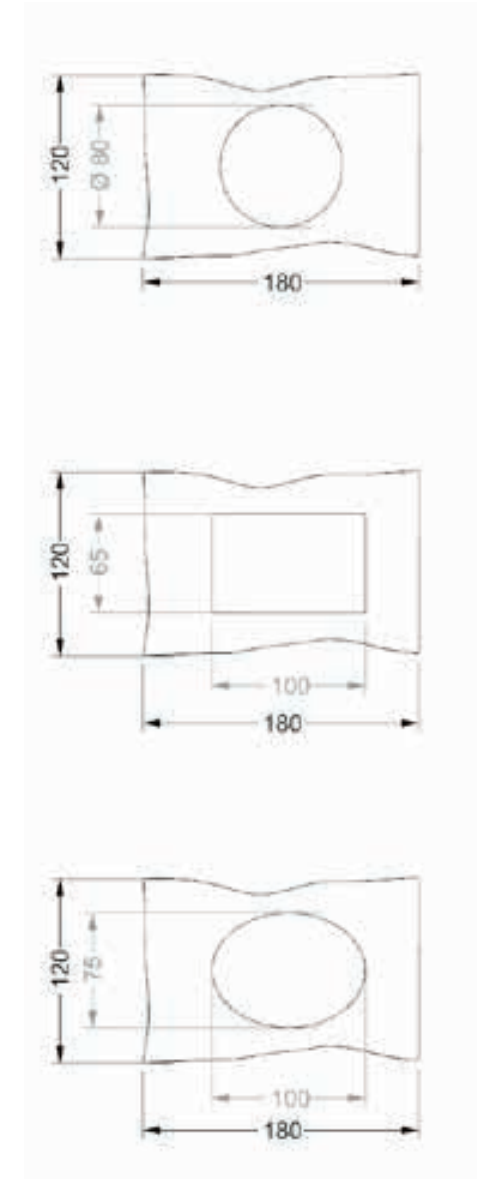

CASANOVA SPECCHIO

Disegno Reflex

Collezione di specchi in vetro extrachiaro con bisello 45° e incisione decorati con elementi in vetro di Murano lavorati a mano uno ad uno disponibili in trasparente, oro zecchino o in diversi colori. Disponibili anche nella versione con impianto luce a LED.

Collection of mirrors in extra clear glass with 45° bevel and engraving decorated with Murano glass elements, handmade one by one, available in transparent, fine gold or various colours. Also available with LED lighting system.





CASANOVA SPECCHIO

Disegno Reflex





decorazione • decorations

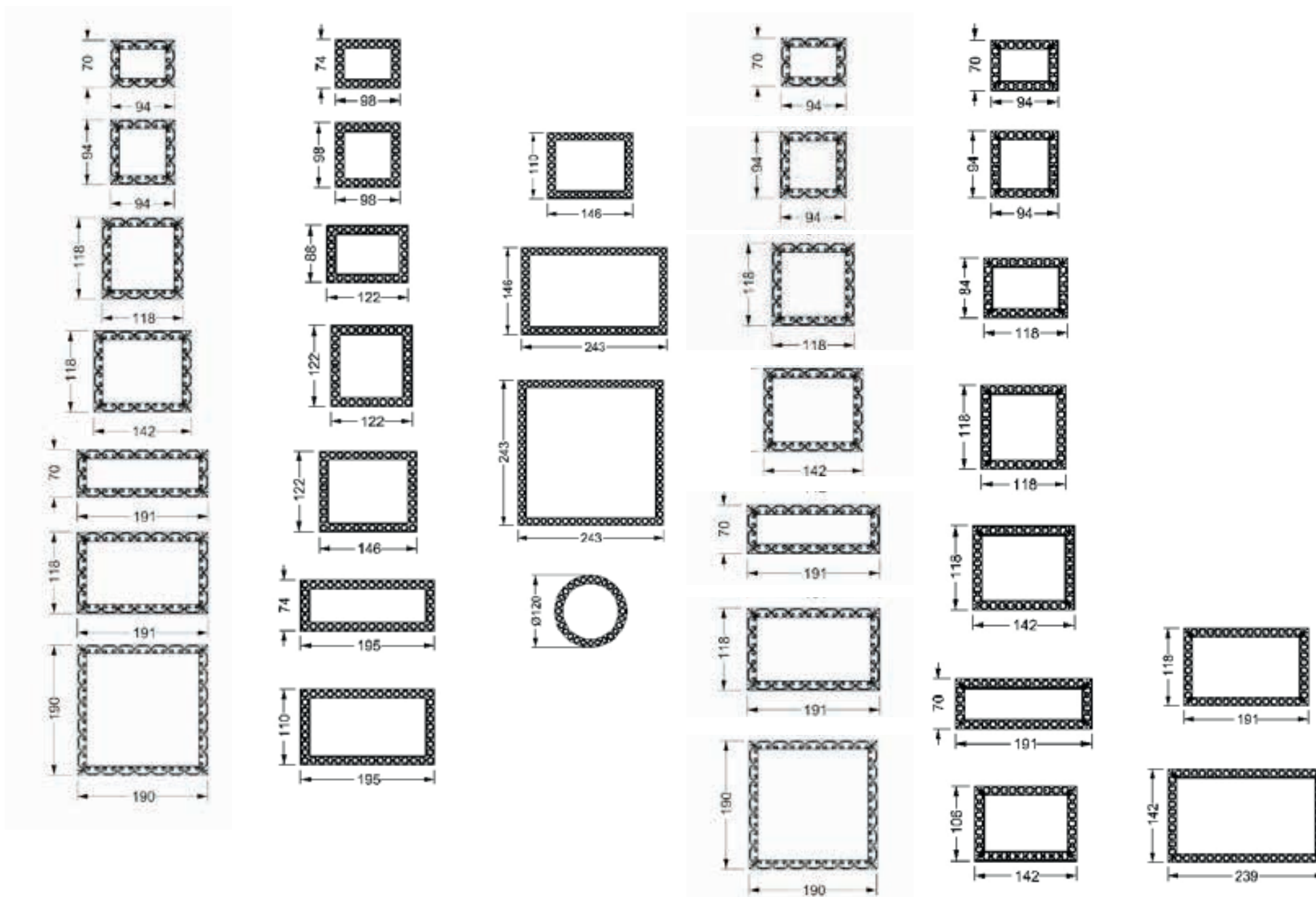
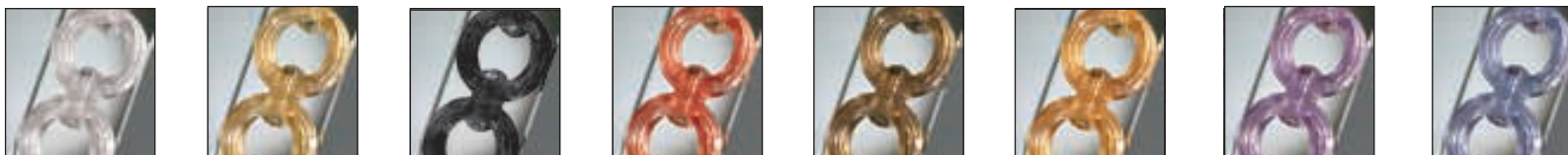

SPECCHI / MIRRORS

BOHEME SPECCHIO

Disegno Reflex

Specchio in vetro extrachiaro spessore 8mm
filo lucido con fascia perimetrale di 7,5cm
di larghezza con incisioni Boheme.

Mirror in extraclear 8mm thick glass with
polished edges and frame with perimetrical
band 7,5cm wide with Boheme engravings.



CA' D'ORO SPECCHIO

Disegno Reflex

Specchio in cristallo extrachiaro con bisello 45° e cornice in vetro con decoro Dune, San Marco o Vienna. Profilo in metallo finitura ottone brunito con illuminazione a LED.

Mirror in extra clear glass with 45° bevel and frame in Dune, San Marco or Vienna pattern design glass. Metal profile in burnished brass finish with LED lighting system.

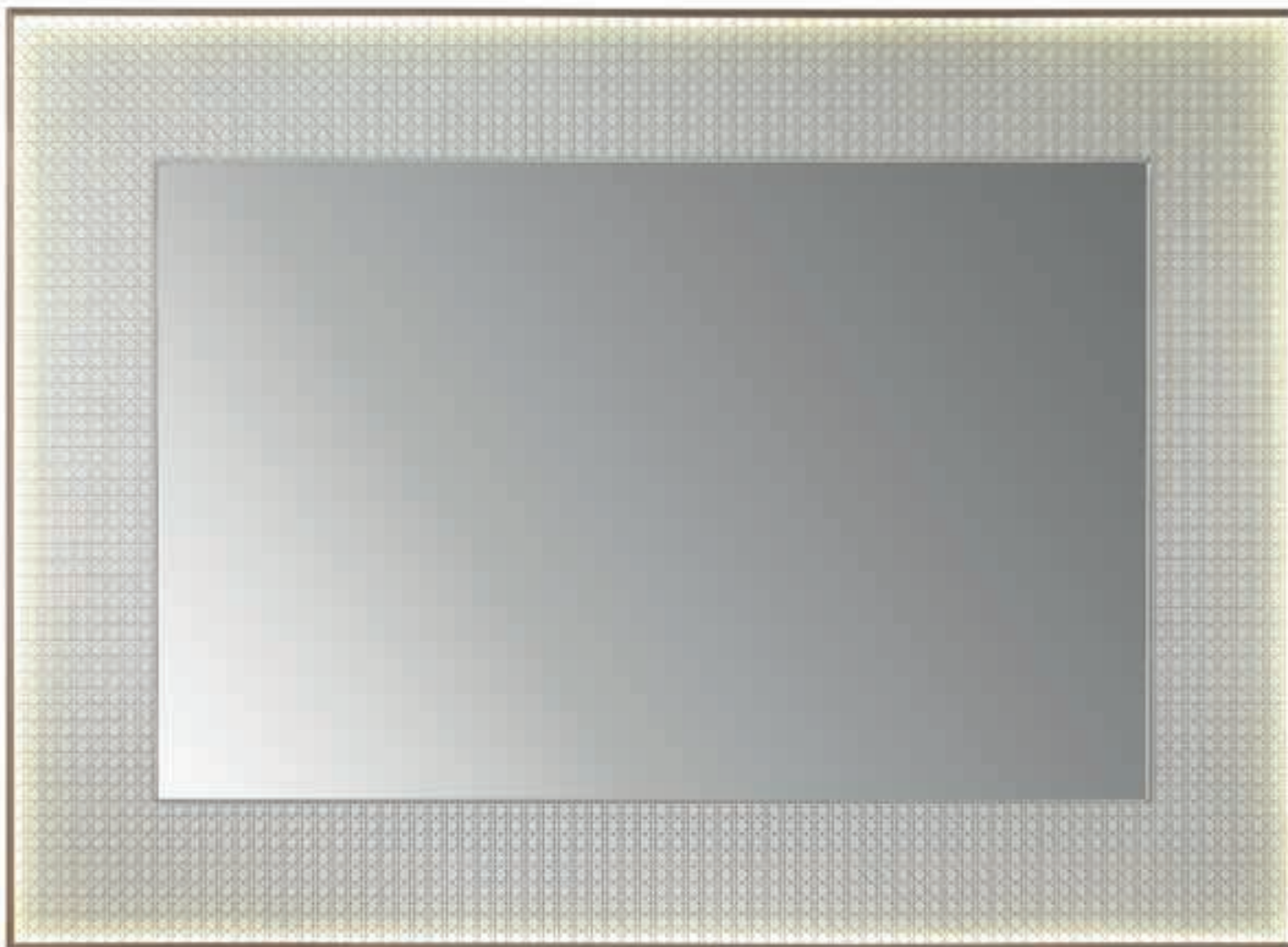

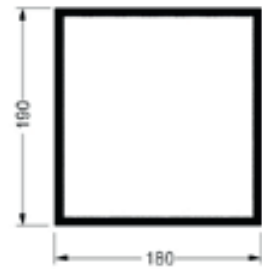
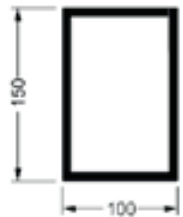
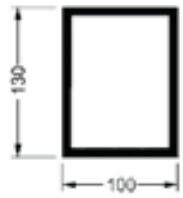

cornice • frame

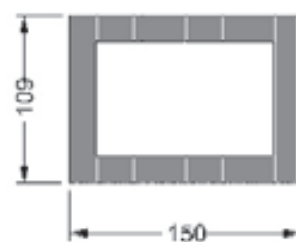
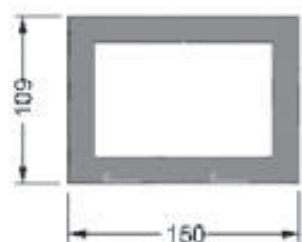
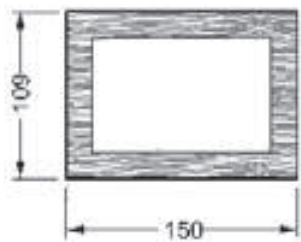
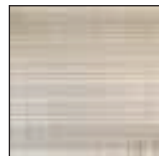
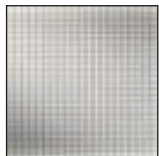
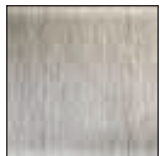

DIAMANTE SPECCHIO TV

Disegno Reflex

Specchio con cornice in cristallo specchio fumé con incisioni "Diamante". Versione per alloggiamento TV in vetro "supersilver" per TV fino a 60".

Mirror with frame in smoked mirror glass with "Diamante" engravings. Version as TV container in "supersilver" glass for TV till 60".

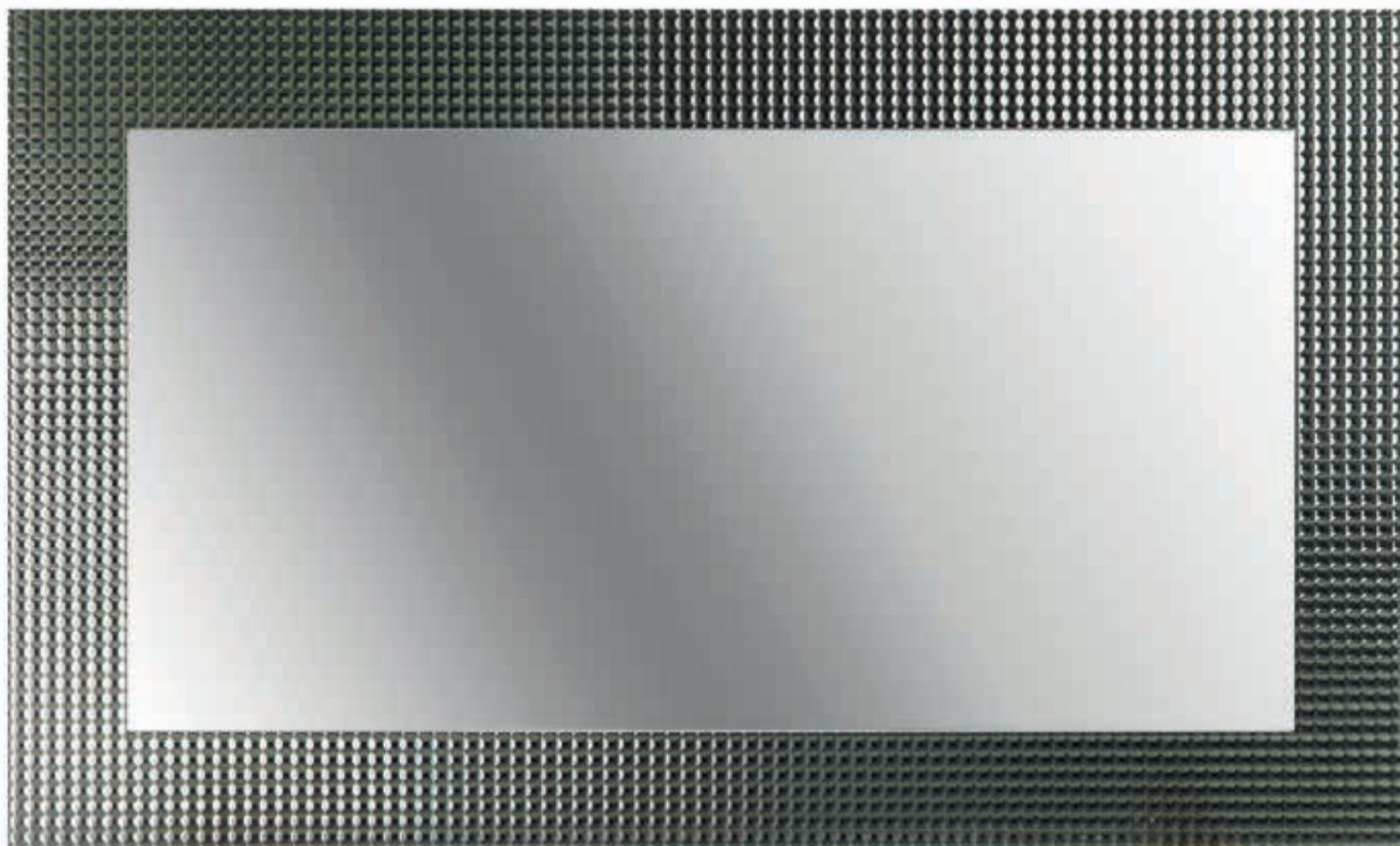

TITANIUM SPECCHIO

Disegno Reflex

Orologio rotondo o rettangolare in vetro extrachiaro a specchio, specchio fumé o Antique mirror blu o grigio. Lancette in titanio. Numeri romani serigrafati grigio fumé oppure in bianco in caso di retroilluminazione a LED opzionale.

Round or rectangular clock in extra clear mirror, smoked mirror or in grey or blue Antique mirror glass. Hands in titanium. Roman numerals in smoked serigraphy or in white in case of back LED lighting.





cornice • frame

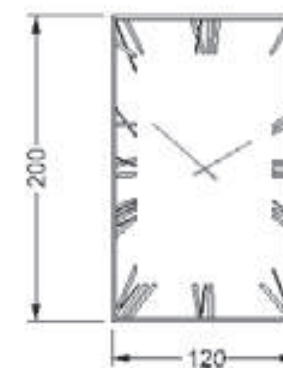
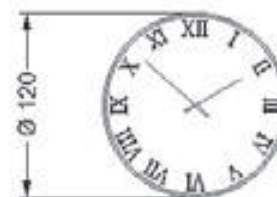
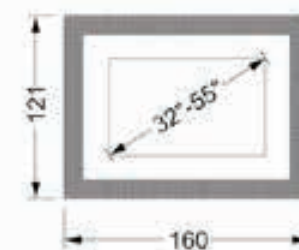
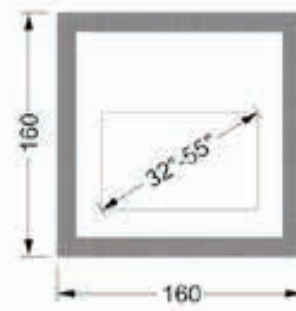
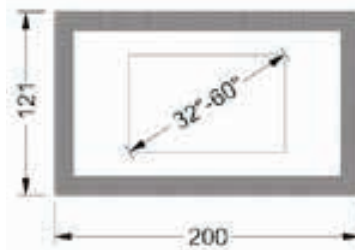
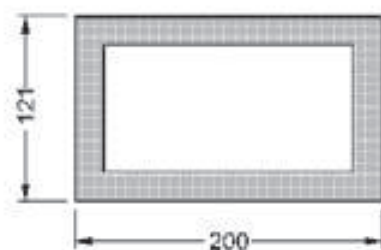
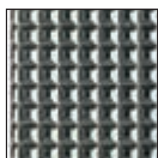

SPECCHI / MIRRORS

PRISMA SPECCHIO

Disegno Reflex

Specchio in vetro extrachiaro con cornice a specchio oppure in vetro verniciato o acidato verniciato. Opzionale: illuminazione a LED nel profilo tra specchio e cornice.

Mirror in extra clear glass with frame in mirror or in shiny or etched lacquered glass. Opzionale: LED lighting system between mirror and frame available as option.



PRISMA SPECCHIO TV

Disegno Reflex

Specchio contenitore Tv in vetro Supersilver con cornice a specchio fumé, in vetro Mesh, vetro Carbonio oppure in vetro verniciato o acidato verniciato. Può contenere televisori fino a 70" con spessore massimo 70mm. Optional: illuminazione a LED nel profilo tra specchio e cornice.

Mirror TV container in Supersilver glass with frame in smoked mirror, in Mesh, in Carbon or in lacquered or etched lacquered glass. It fits televisions till 70" with a maximum thickness of 70mm. Optional: LED lighting system between mirror and frame.



SPECCHI / MIRRORS

FIOCCO SPECCHIO

Disegno Reflex

Specchio dotato di cornice in vetro di Murano rigato e acidato bianco, azzurro, verde o tè con finitura lucida. Disponibile nella versione orizzontale o verticale.

Mirror with ribbed Murano glass frame available in etched white or in shiny light blue, green or tea colour. Available in horizontal or vertical position.



cornice • frame

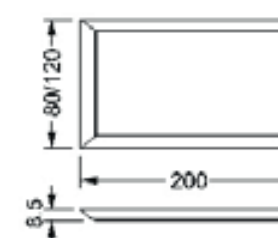
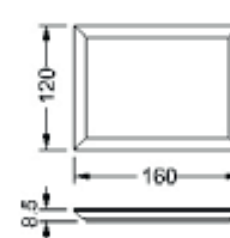
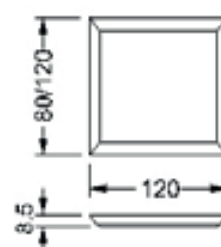
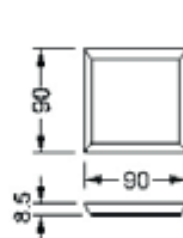
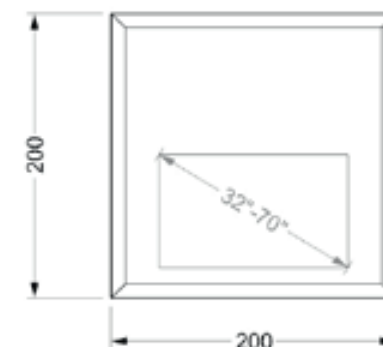
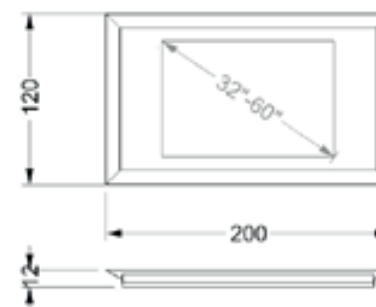
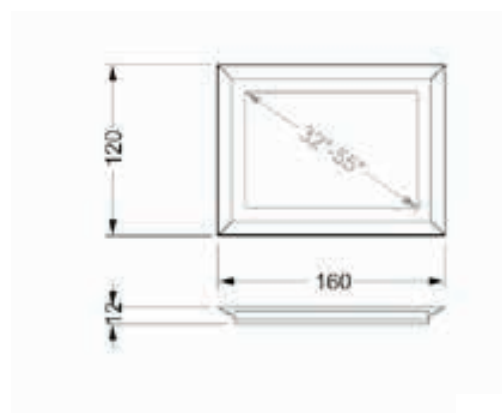
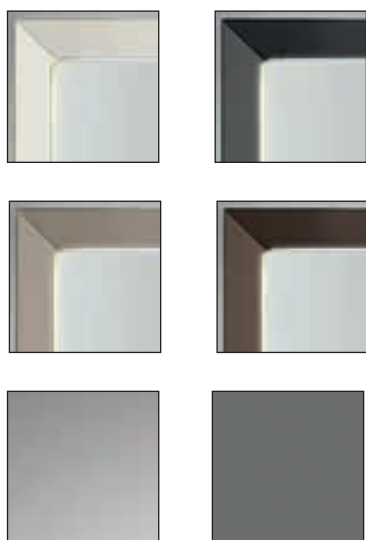

FIOCCO SPECCHIO

FINITURE • FINISHES

SCHEDA TECNICA • TECHNICAL DRAWINGS

cornice • frame

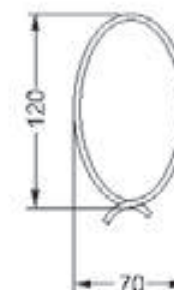
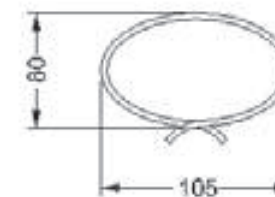

SPECCHI / MIRRORS

VENEZIA SPECCHIO

Disegno Matteo Baroni

Specchio in vetro extrachiaro sp. 8mm con bisello. Cornice curvata in vetro extrachiaro acidato con incisioni. Illuminazione LED tra specchio e cornice.

Mirror in 8mm thick extra clear glass with bevel. Curved in extra clear etched glass with engravings. LED light between mirror and frame.





SPECCHI / MIRRORS

GALASSIA SPECCHIO

Disegno Studio Viganò

Specchio extrachiaro spessore 5 mm con bisello con cornice in legno finitura ottone antico scuro e acciaio satinato.

Extra clear mirror glass 5 mm thick with bevel with wooden frame in antiqued dark brass and satin steel finishing.



Cornici • Frames

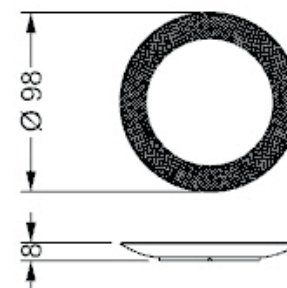
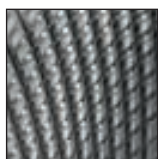

Cornici • Frames

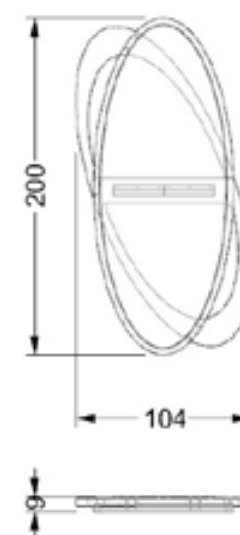

399	<i>BOUQUET collezione</i>
389	<i>BULLES lampadario</i>
390	<i>BULLES TORCHON</i>
391	<i>BULLES XL abatjour e applique</i>
392	<i>BULLES XL piantana</i>
370	<i>CANDELABRO collezione</i>
364	<i>CASANOVA lampadario</i>
365	<i>CASANOVA applique</i>
375	<i>CHARLESTON collezione</i>
377	<i>CHARLESTON ovale</i>
367	<i>COMETE lampadario</i>
379	<i>DIAMANTE lampadario</i>
380	<i>DIAMANTE applique</i>
382	<i>GRAN CANAL collezione</i>
383	<i>GHIBLI collezione</i>
372	<i>ICE collezione</i>
368	<i>LEAF lampadario</i>
404	<i>LUCCIOLA piantana</i>
402	<i>PLISSE' piantana</i>
395	<i>SIRIUS</i>
386	<i>STELLA lampadario</i>
401	<i>TERRA piantana e applique</i>

CASANOVA LAMPADARIO

Disegno Reflex

Collezione di lampadari modulari. Telaio a specchio, struttura metallica con finitura lucida e decori in vetro di Murano trasparente. Impianto luce con lampade alogene o a LED. Possibilità di personalizzazione per dimensioni e forme su richiesta.

Collection of modular chandeliers with mirror supports, shiny metal structure and transparent Murano glass elements. Lighting system with halogen bulbs or LED. Customized versions per dimensions and shapes available on request.



ILLUMINAZIONE / LIGHTING

CASANOVA APPLIQUE

Disegno Reflex

Applique con telaio a specchio, struttura metallica con finitura lucida e decori in vetro di Murano trasparente. Impianto luce con lampade alogene o a LED.

Wall lamp with mirror supports, shiny metal structure and transparent Murano glass elements. Lighting system with halogen bulbs or LED.



elementi • elements

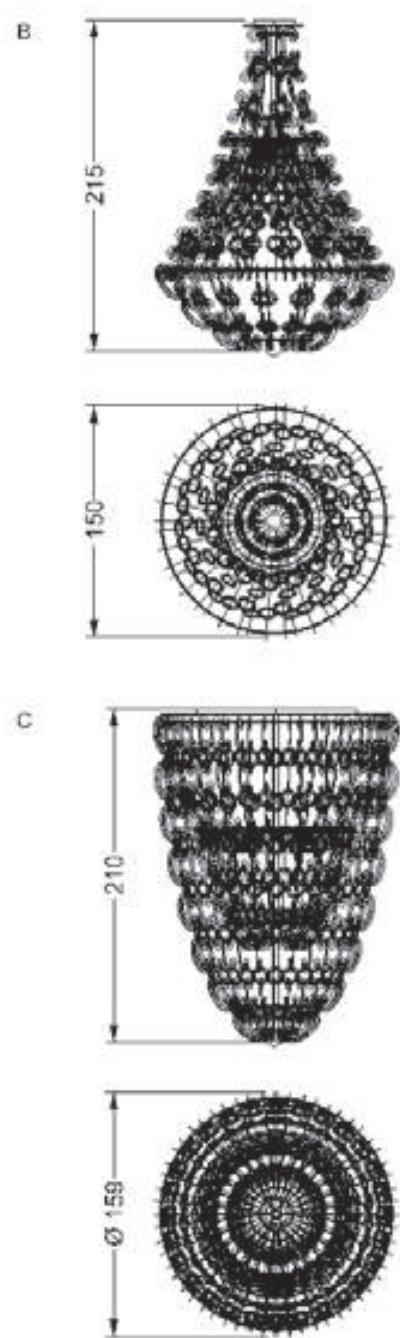
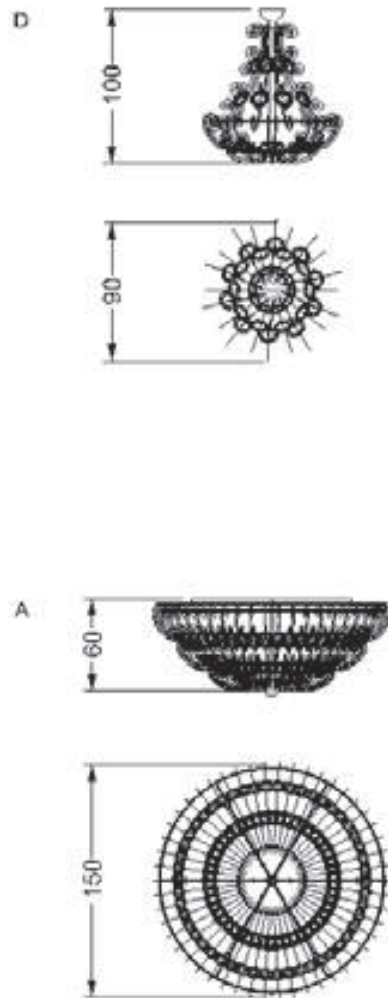
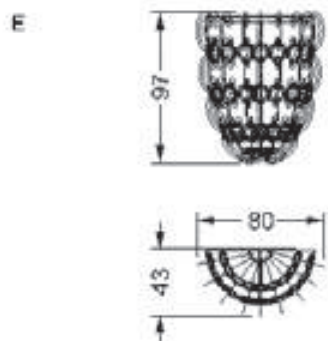
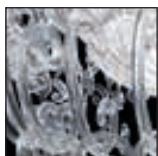

ILLUMINAZIONE / LIGHTING

COMETE LAMPADARIO

Disegno Reflex

Lampadario con telaio in vetro a specchio.
Elementi pendenti in vetro trasparente. Illuminazione a LED.

Ceiling lamp with mirror glass structure.
Pendant glass elements with LED bulbs



LEAF LAMPADARIO

Disegno Emanuele Missaglia

Lampadario con telaio in cristallo a specchio con LED e foglie pendenti in cristallo curvato acidato o in oro zecchino 24k.

Chandelier with mirror glass structure and built-in LED. Pendant leaves in curved glass, etched finish or in 24k fine gold.



Telaio in vetro • Glass Support



Pendenti • Suspended elements

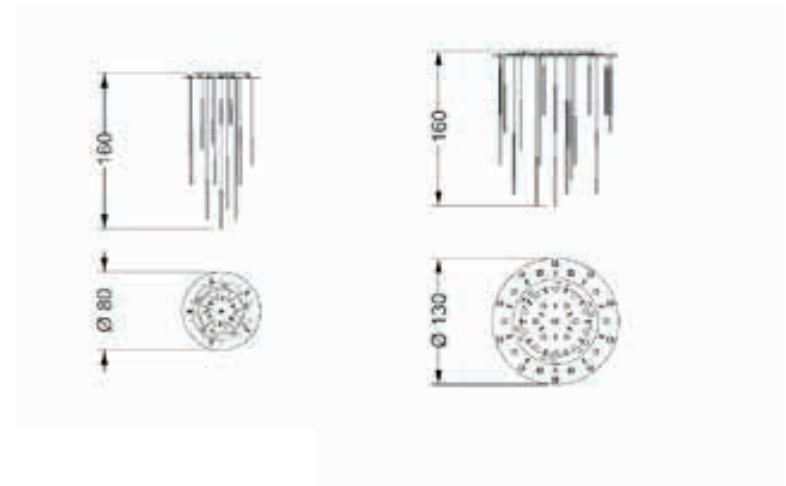
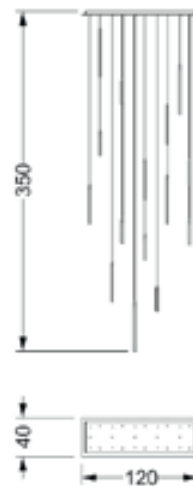
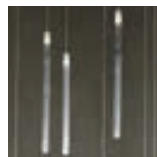

foglie • leaf

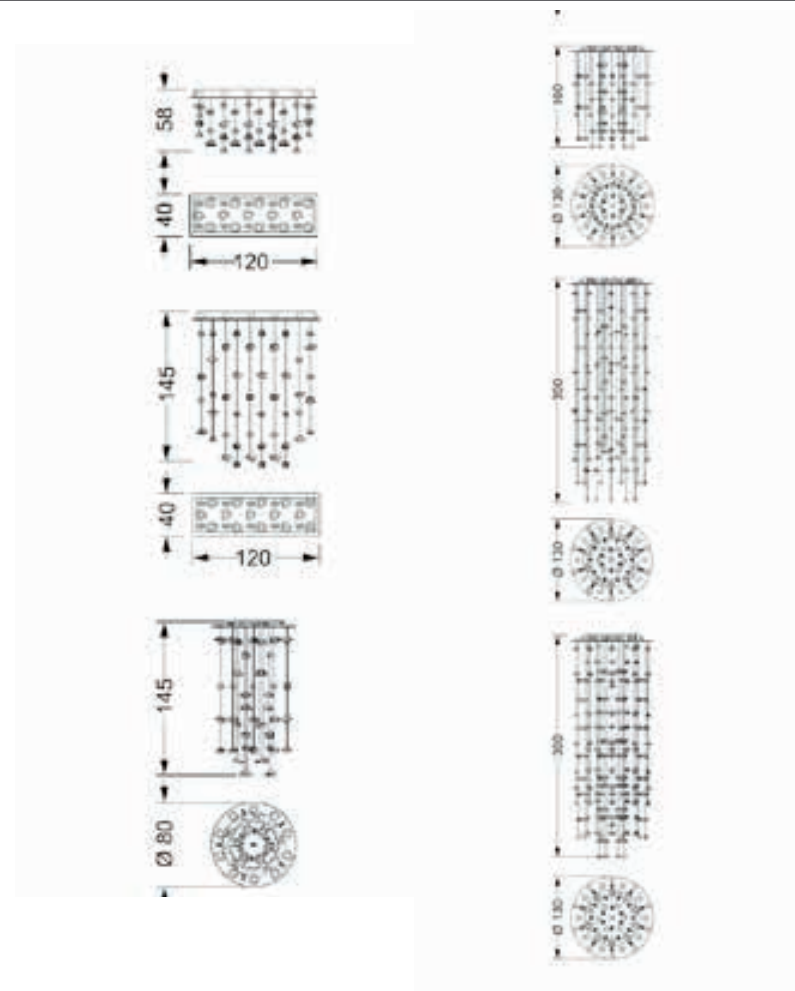

CANDELABRO COLLEZIONE

Disegno Reflex

Collezione composta da lampadario e applique con bracci con gocce pendenti in cristallo trasparente e dettagli in metallo cromato. Candele in vetro di Murano soffiato con anima centrale dotata di lampadina a LED.

Collection made up of chandelier and wall lamp with transparent glass arms and pendant crystal drops. Details in chromed metal. Candles in blown Murano glass with central LED bulb.



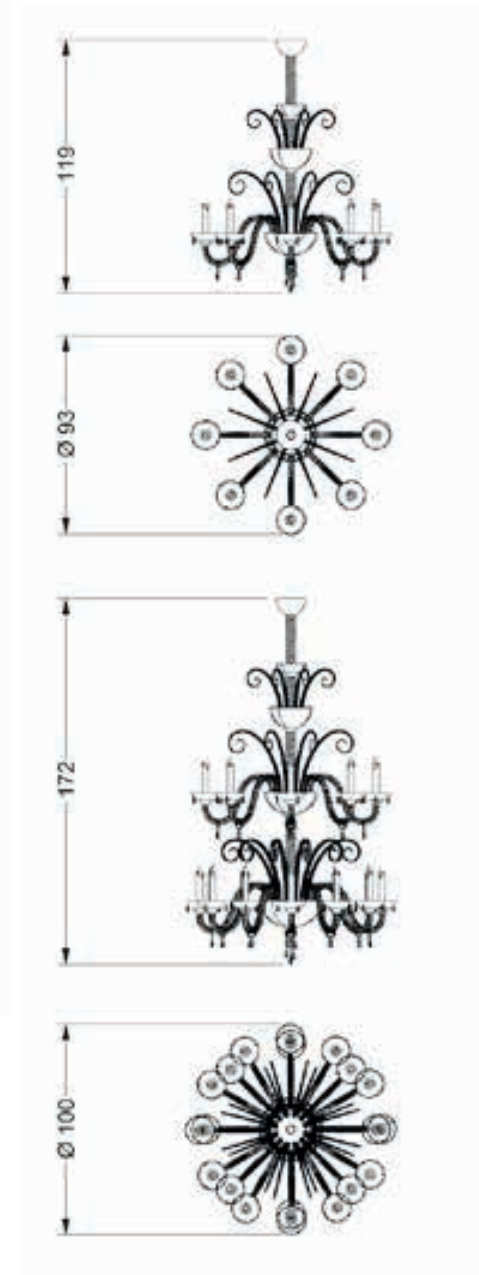
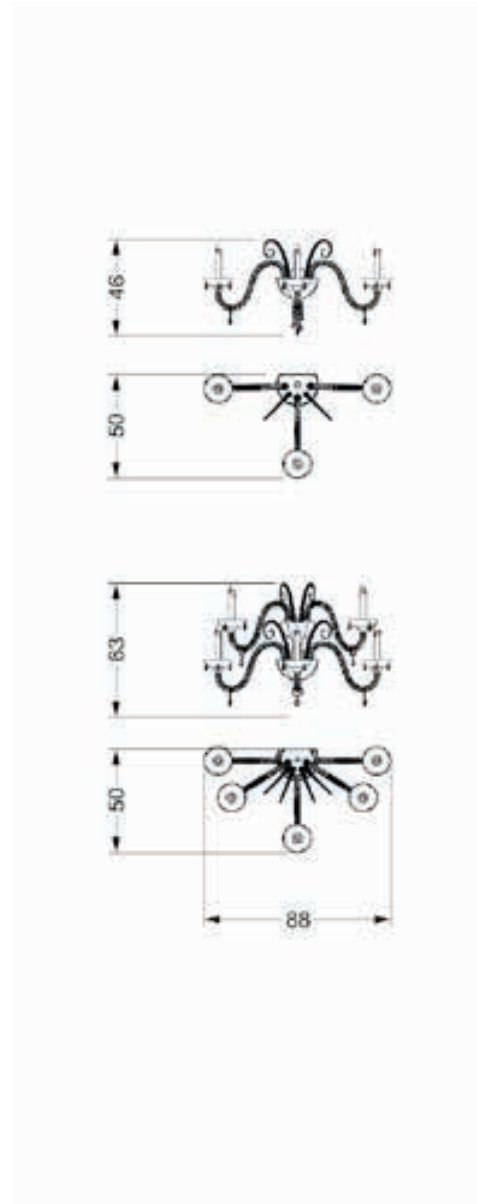

ICE

Disegno Reflex

Collezione composta da lampadario e applique con telaio in vetro a specchio ed elementi pendenti in vetro di Murano massiccio con LED interno.

Collection of chandelier and wall lamp with mirror glass support and suspended solid Murano glass elements with LED inside.





elementi • elements

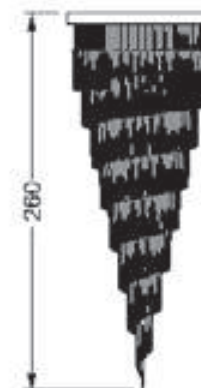
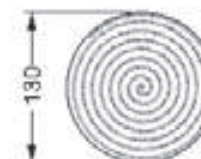
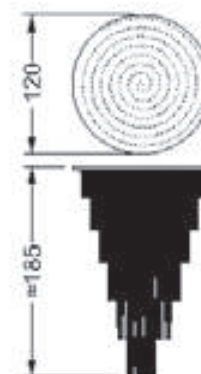
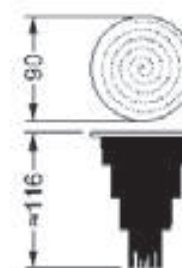
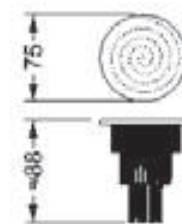
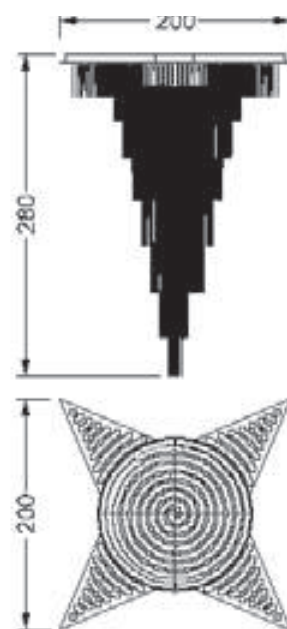
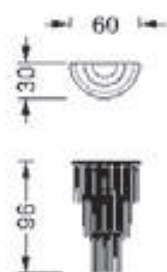

CHARLESTON COLLEZIONE

Disegno Reflex

Collezione composta da lampadario, sospensione, piantana, abatjour e applique con struttura in acciaio inox lucidato a specchio. Paralume composto da stecche in vetro di Murano trasparente o con aggiunta di stecche in colore nero, ametista o acquamarina. Impianto luce con lampade alogene o LED.

Collection of chandelier, pendant lamp, floor lamp, table lamp and wall lamp with structure in polished inox-steel. Lampshade made of transparent Murano glass sticks with possible addition of coloured sticks in black, amethyst or aquamarine. Lighting system with halogen bulbs or with LED.





CHARLESTON OVALE

Disegno Reflex



stecche in vetro • glass sticks

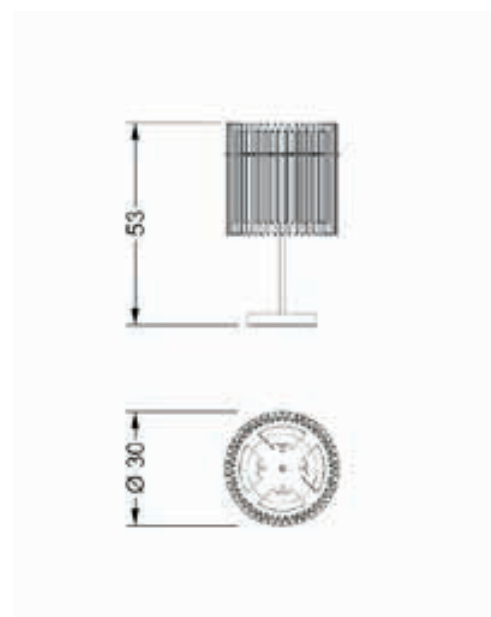
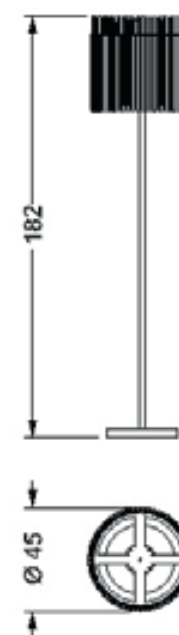
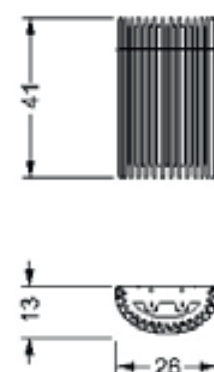
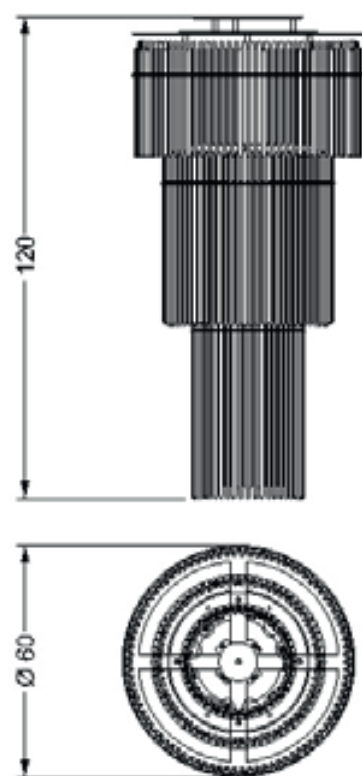
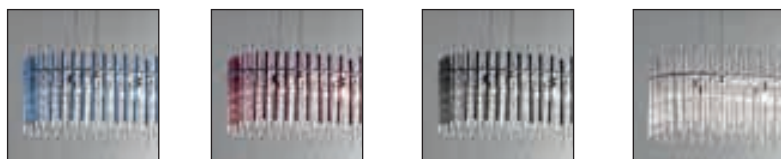

DIAMANTE LAMPADARIO

Disegno Reflex

Collezione di lampadari e applique con struttura in metallo lucido. Prismi in cristallo extrachiaro e decoro centrale in vetro colorato. Impianto luce con lampade alogene o a LED.

Collection of chandeliers and wall lamp with shiny metal structure. Prisms in extra clear glass and central coloured glass decoration. Lighting system with halogen bulbs or with LED.



ILLUMINAZIONE / LIGHTING

DIAMANTE APPLIQUE

Disegno Reflex



elementi • elements



elemento centrale • central element

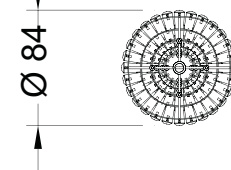
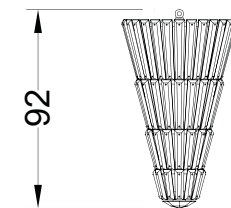
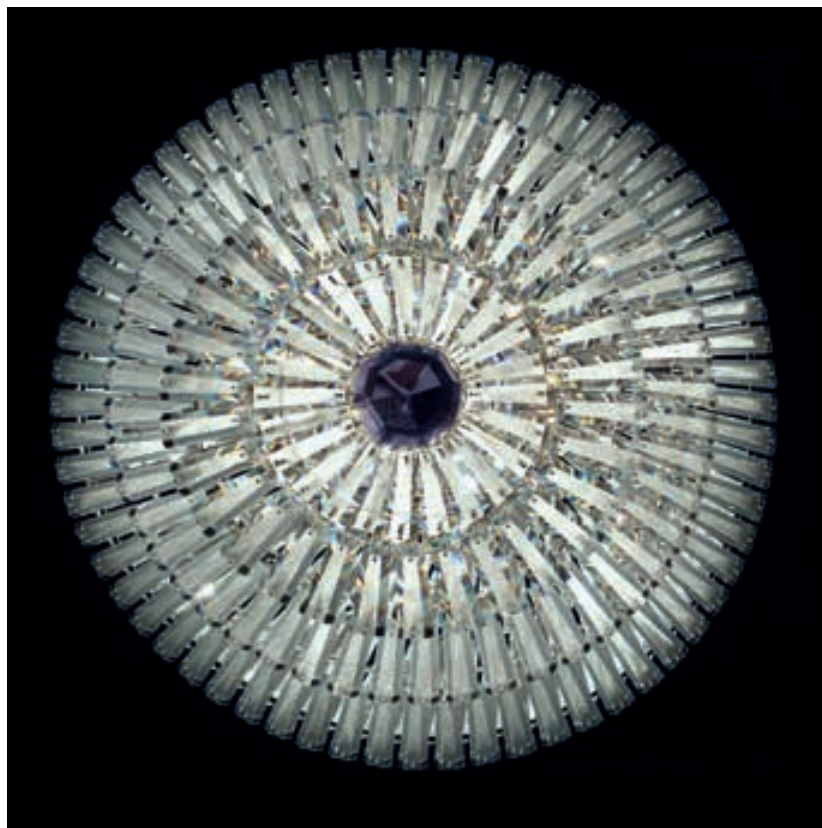
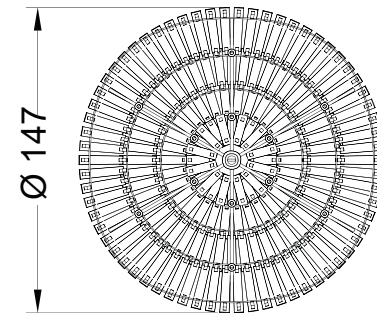
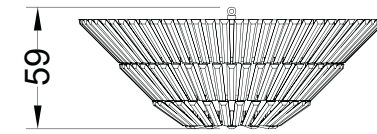
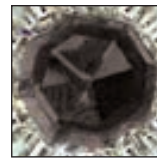
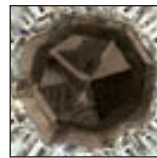
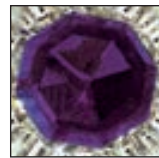
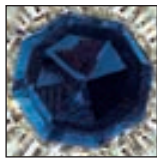
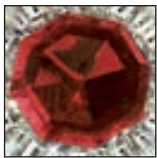

applique

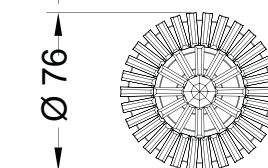
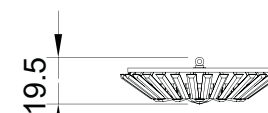

GRAN CANAL COLLEZIONE

Disegno Riccardo Lucatello

Piantana e lampada da tavolo con stelo in vetro di Murano trasparente liscio o rigato o in vari colori. Paralume in tessuto pongé coprente nero, bianco o avorio. Base in vetro trasparente, a specchio o verniciato. Impianto luce con lampade a LED.

Floor and table lamp with leg in Murano glass, transparent smooth or ribbed or in various colours. Lampshade in black, white or ivory pongé fabric. Base in transparent, mirror or lacquered glass. Lighting system with LED bulbs.



GHIBLI COLLEZIONE

Disegno Reflex

Piantana e lampada da tavolo con base in vetro di Murano rigato trasparente, nero, ametista, rosso rubino o oro. Paralume in tessuto pongè coprente bianco, avorio o nero. Impianto luce con lampadina a LED.

Floor and table lamp with base in transparent, black, amethyst, red or gold ribbed Murano glass. Lampshade in white ivory or black pongè heavy fabric. Lighting system with LED bulb.



stelo • leg



paralume • lampshade

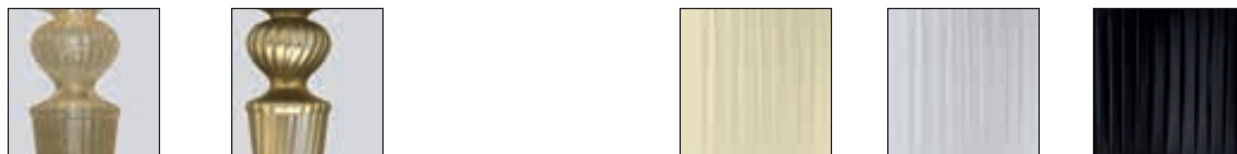

base • base

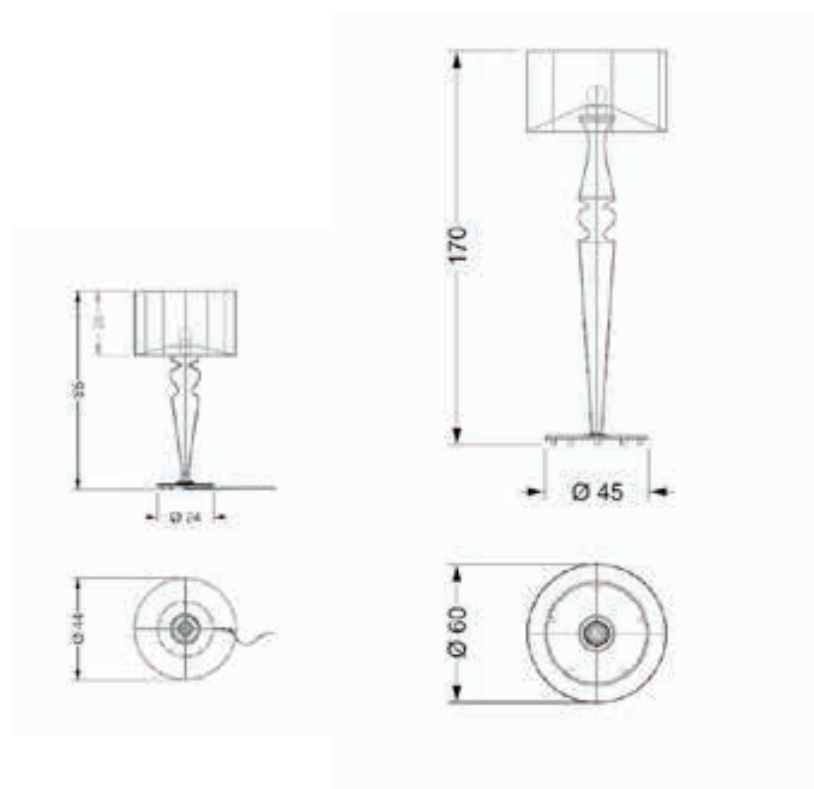
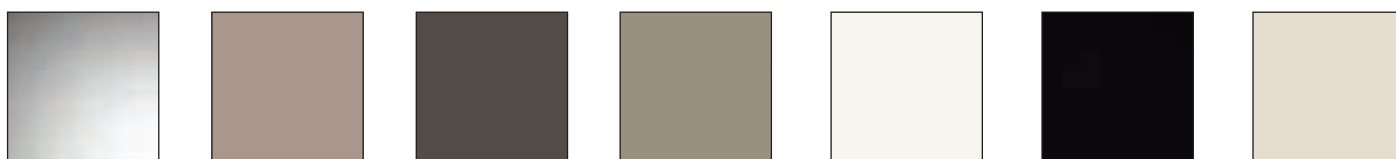

stelo • leg



paralume • lampshade



SCHEDA TECNICA • TECHNICAL DRAWINGS

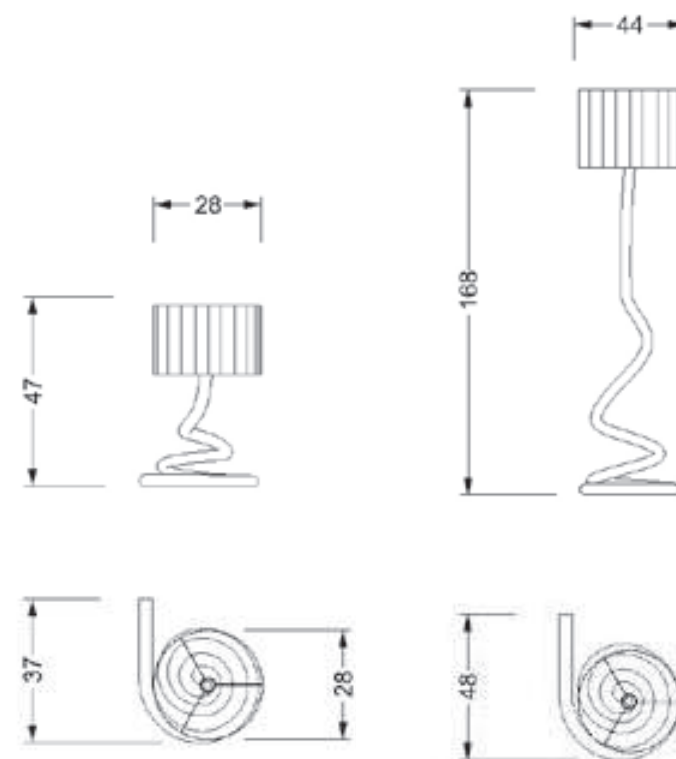

STELLA LAMPADARIO

Disegno Reflex

Lampadario con telaio in vetro verniciato bianco, nero o a specchio. Dotato di 5, 12, 25, 50, 105, 153, 232 stelle in vetro borosilicato trasparente liscio o colorato. Lampadine alogene o a LED.

Chandelier with painted glass support in white, black or mirror finish. Provided with 5, 12, 25, 50, 105, 153, 232 pendant stars in transparent or coloured borosilicate glass. LED or halogen bulbs.



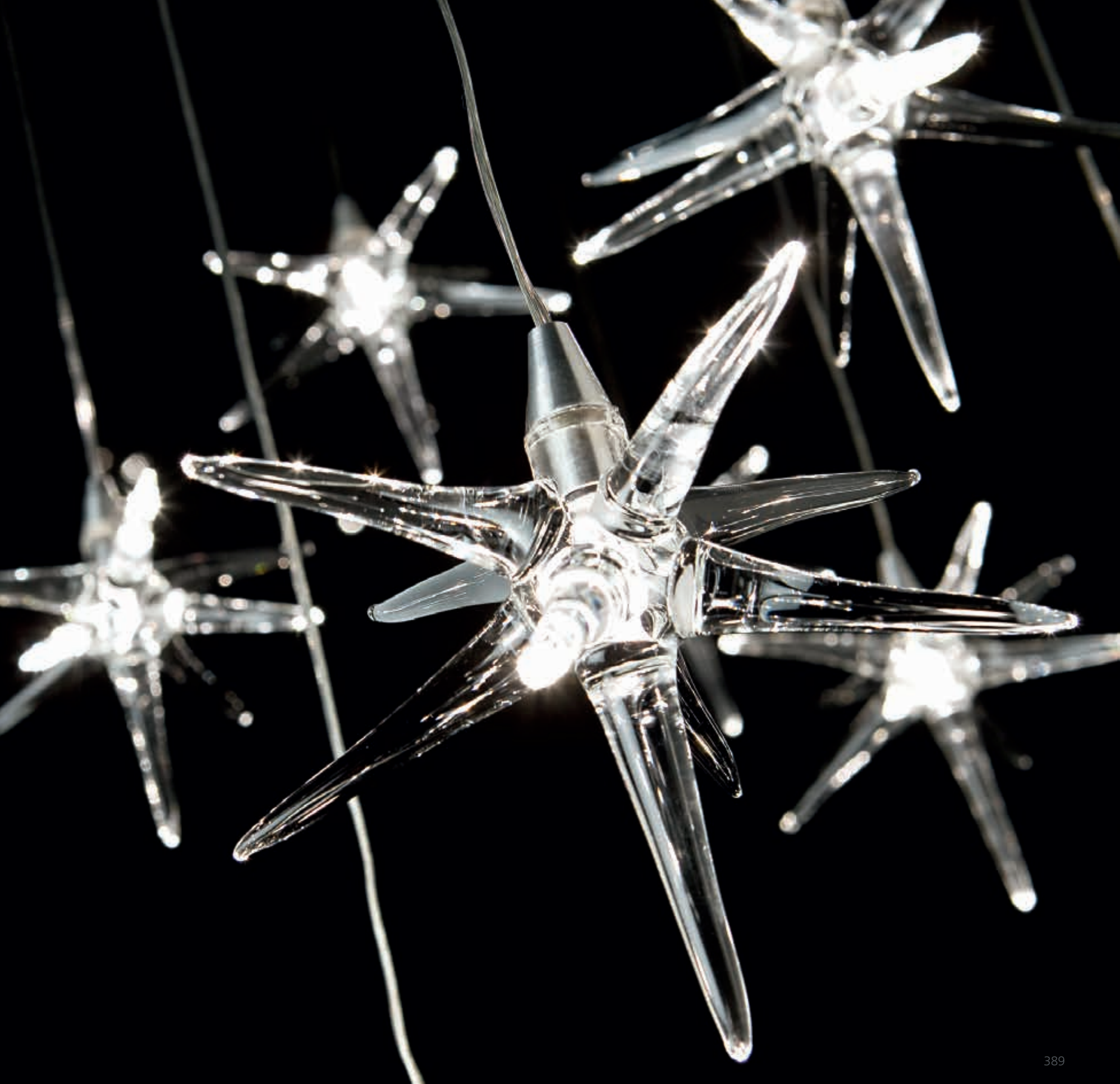

stelle • stars



supporto • support



special

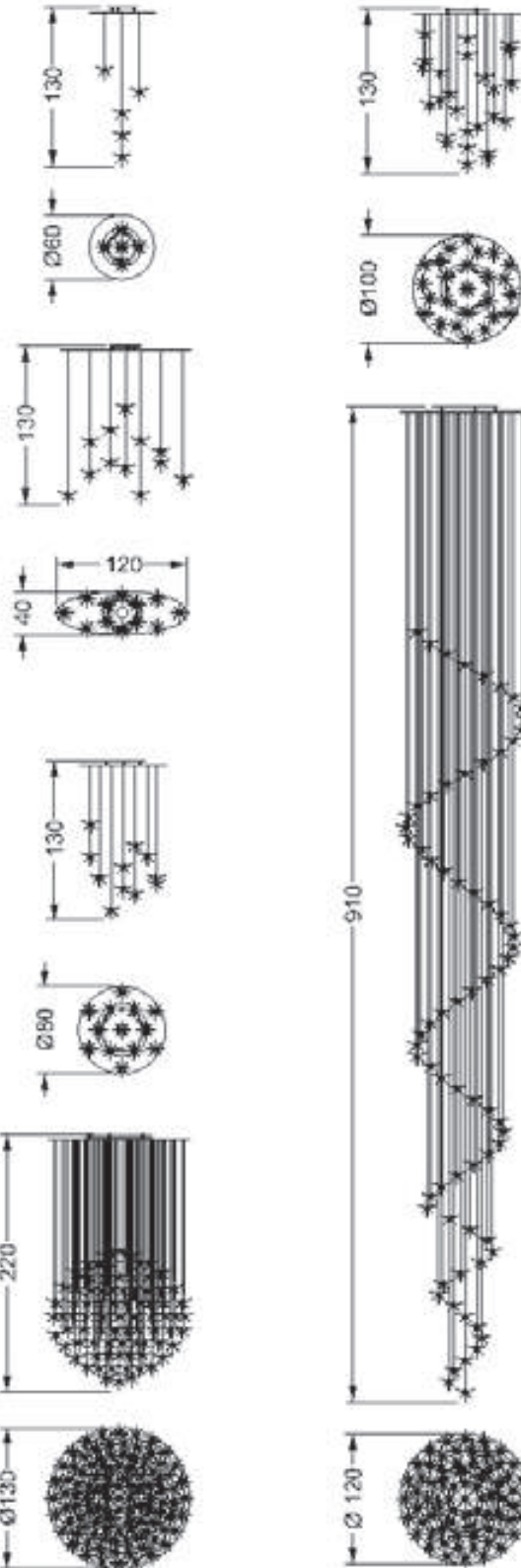
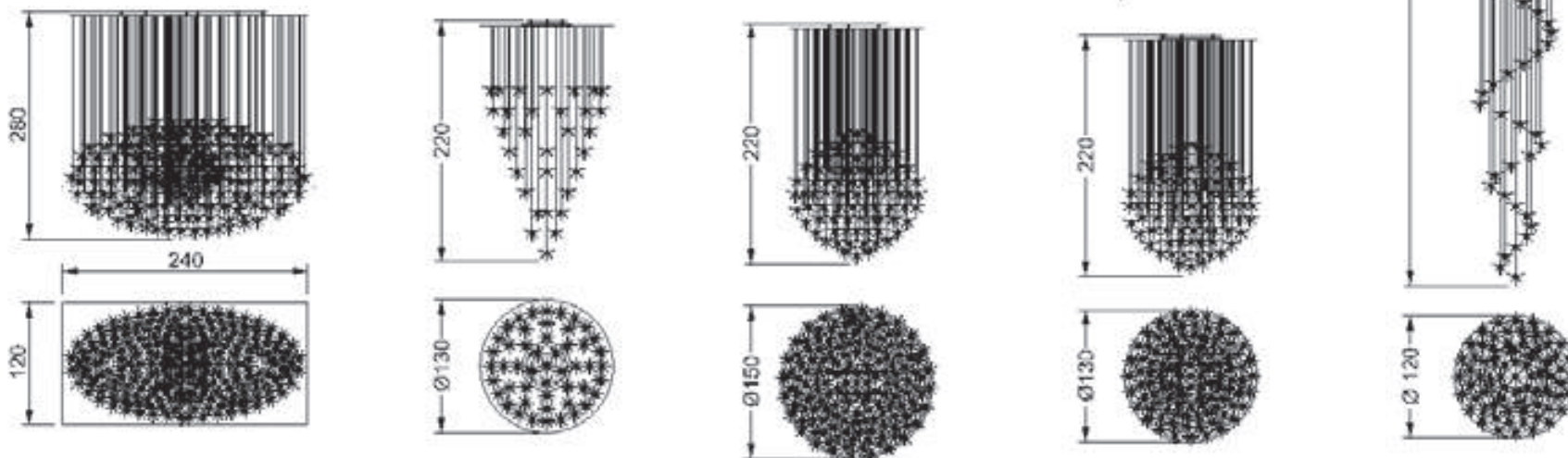

BULLES LAMPADARIO

Disegno Reflex

Lampadario con telaio in vetro verniciato bianco, nero o a specchio. Dotato di 5, 12, 25, 50, 105, 153 o 178 sfere in vetro borosilicato trasparente liscio o colorato. Lampadine alogene o a LED.

Chandelier with painted glass support in white, black or mirror finish. Provided with 5, 12, 25, 50, 105, 153 or 178 pendant spheres in transparent or coloured borosilicate glass. LED or halogen bulbs.



BULLES TORCHON

Disegno Reflex

Lampadario con telaio in vetro verniciato bianco, nero o a specchio. Dotato di 5, 12, 25, 50, 105 o 153 sfere in vetro borosilicato trasparente o colorato con lavorazione torchon. Lampadine alogene o a LED.

Chandelier with painted glass support in white, black or mirror finish. Provided with 5, 12, 25, 50, 105 or 153 pendant spheres in transparent or coloured borosilicate glass with torchon decoration. LED or halogen bulbs.



BULLES XL ABATJOUR e APPLIQUE

Disegno Reflex

Lampade da tavolo con struttura in acciaio satinato e dettagli in ottone antico scuro. Sfere in vetro borosilicato in finitura 'filtro luce' con illuminazione a LED. Applique con telaio in vetro specchio fumé o con incisione London con sfere in finitura 'filtro luce' e illuminazione a LED.

Table lamps with structure in glazed steel and details in antiqued dark brass. Spheres in borosilicate glass with 'light filter' finish and LED lighting system. Wall lamp with structure in smoked mirror glass or with London engravings. Spheres in borosilicate glass with 'light filter' finish and LED lighting system.



BULLES XL PIANTANA

Disegno Reflex

Piantana con struttura in acciaio satinato, regolabile nell'inclinazione. Dettagli in ottone antico scuro. Dotata di una sfera Ø16 cm in vetro borosilicato finitura 'filtro luce' argento e di due sfere Ø20 cm in vetro borosilicato finitura 'filtro luce' oro e rame.

Floor lamp with structure in glazed steel finish, with adjustable inclination. Details in antiqued dark brass. Equipped with one sphere in borosilicate glass diam. 16 cm, silver 'light filter' finish and two spheres in borosilicate glass diam. 20 cm, gold and copper 'light filter' finish. LED lighting system.



sfere • spheres

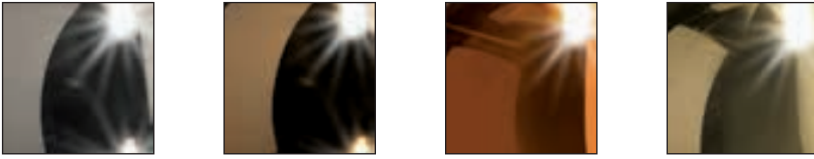

SCHEDA TECNICA • TECHNICAL DRAWINGS

Lampadario • Chandelier

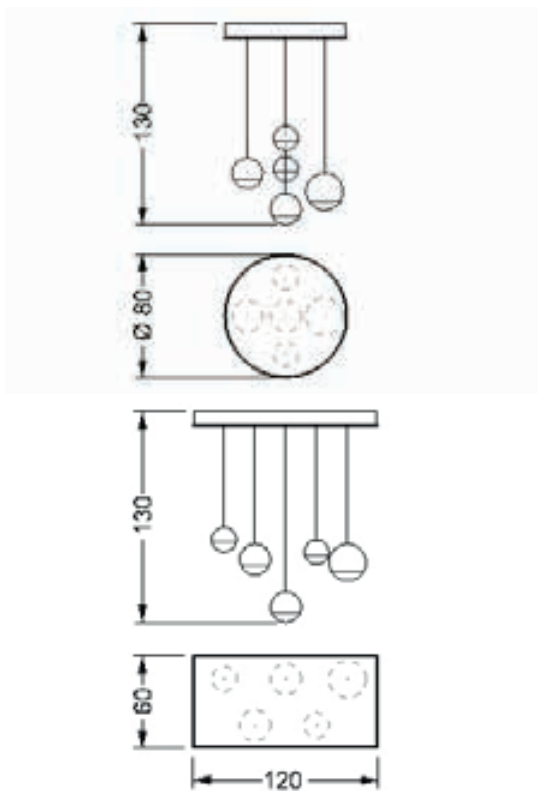

Singolo elemento • Single element

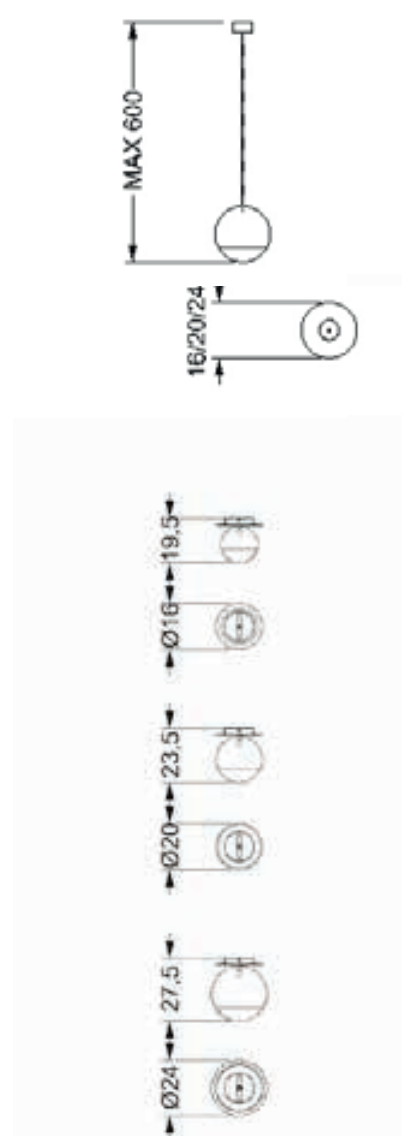

Abatjour • Table lamp

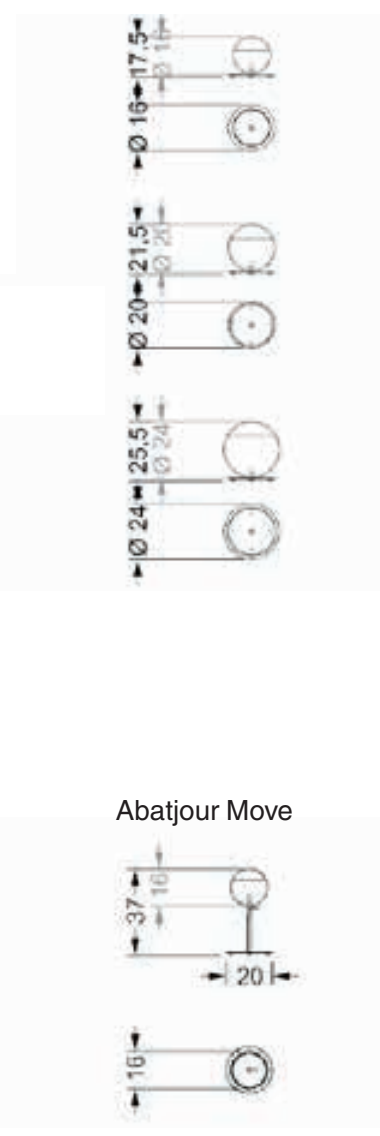

Applique • Wall lamp

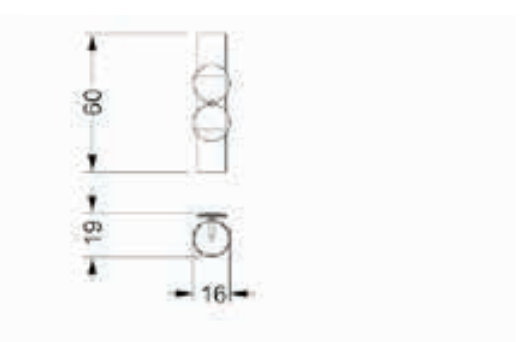

Piantana • Floor lamp



sfere • spheres

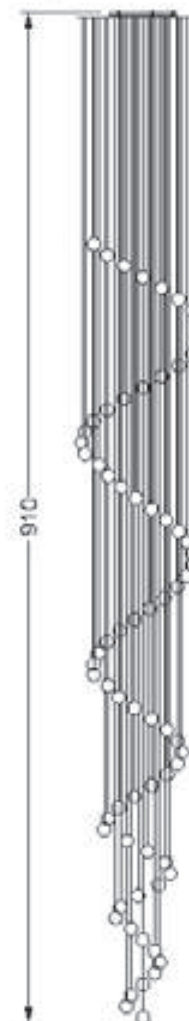
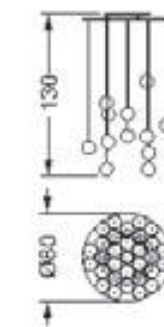
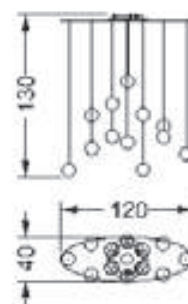
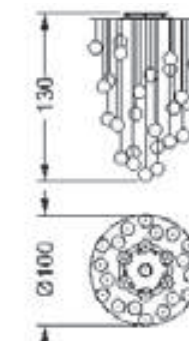
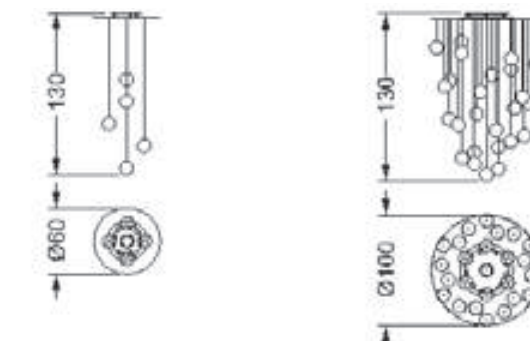
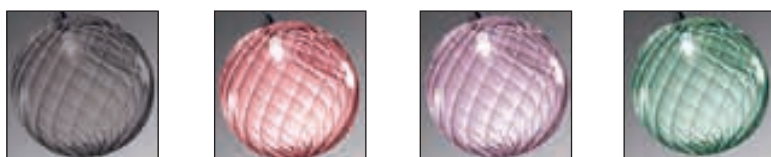

supporto • support

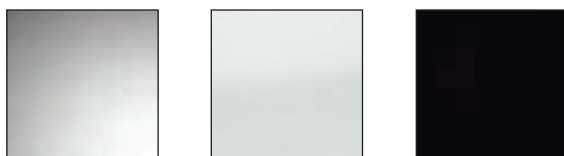

Bulles special

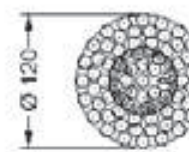
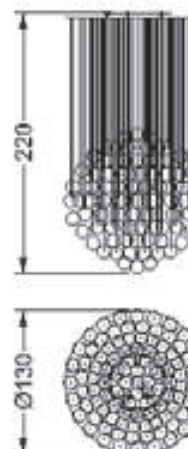
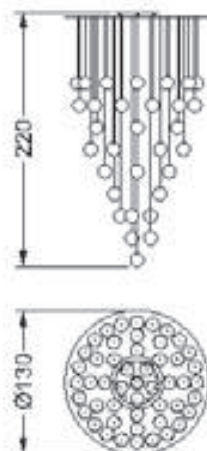
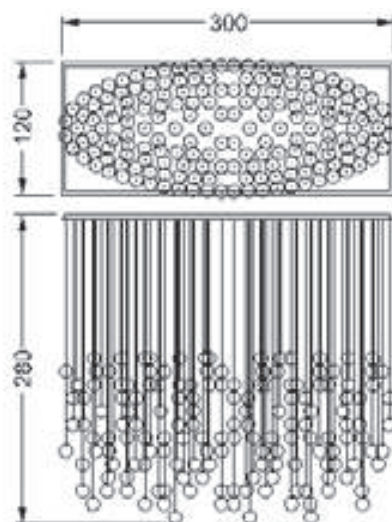

SIRIUS

Disegno Reflex

Lampadario con telaio in vetro verniciato bianco, nero o a specchio. Dotato di 5, 12, 25, 50, 100 o 178 elementi in vetro borosilicato trasparente o colorato. Lampadine alogene o a LED.

Chandelier with painted glass support in white, black or mirror finish. Provided with 5, 12, 25, 50, 100 or 178 pendant elements in transparent or coloured borosilicate glass. LED or halogen bulbs.

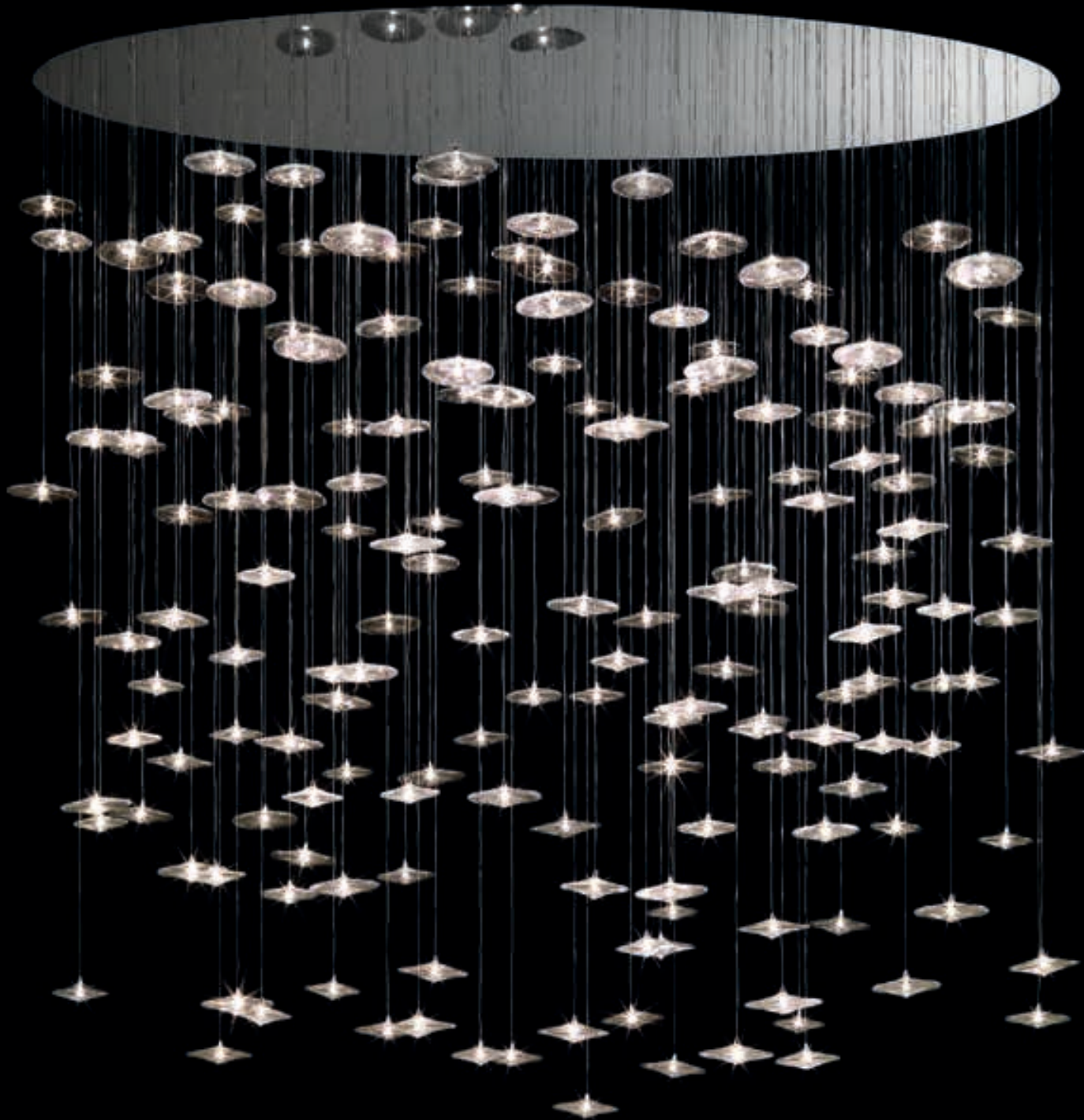





pendenti vetro •



supporto • support



special

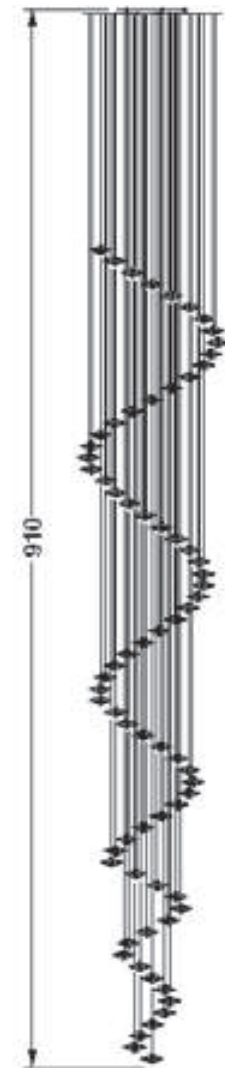
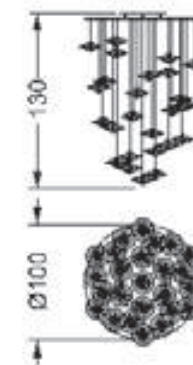
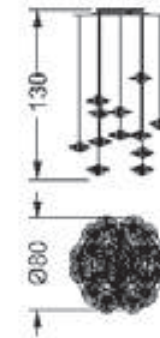
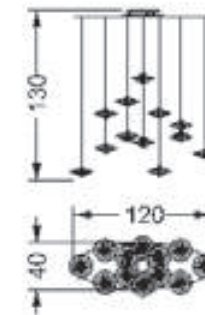
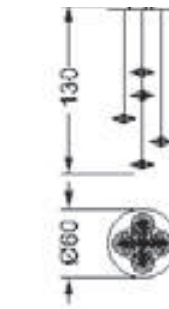
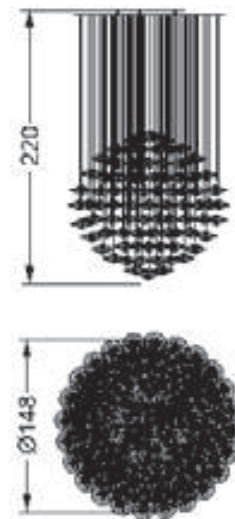
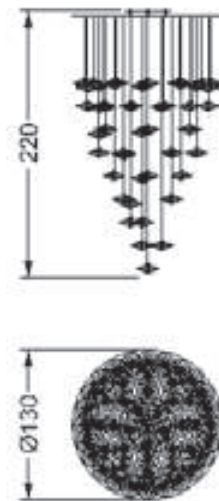
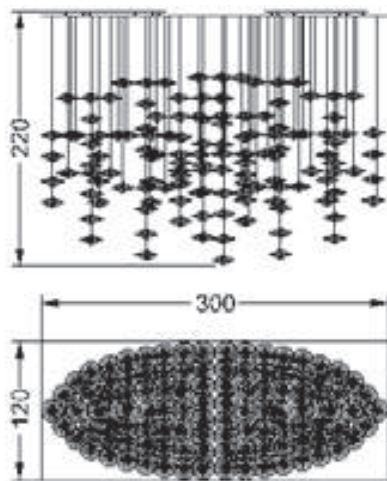

BOUQUET COLLECTION

Disegno Reflex

Collezione composta da lampada a sospensione, abatjour e applique con telaio in ferro, paralume in tessuto plissettato e con applicazione di decori floreali in vetro di Murano trasparente, lavorati a mano uno ad uno. Impianto luce con lampade a LED.

Collection of pendant lamp, table lamp and wall lamp with iron support, lampshade in plissé fabric, with application of flower decorations in transparent handmade Murano glass. Lighting system with LED bulbs.



deco • decoration



tessuto • fabric

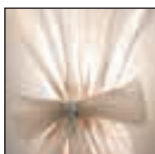

SCHEDA TECNICA • TECHNICAL DRAWINGS

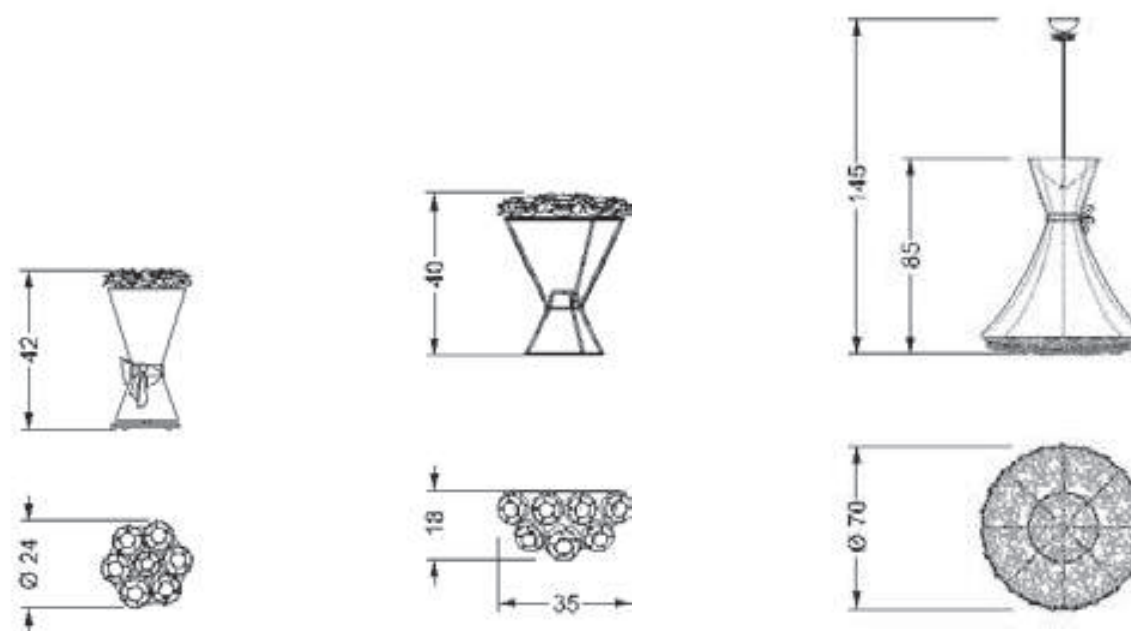

TERRA PIANTANA e APPLIQUE

Disegno Reflex

Piantana e applique in vetro extrachiaro curvato con lavorazione a foglia oro. Telaio in metallo finitura Corten. Lama verticale in ottone brunito con impianto luce a LED. Piantana dotata di supporto girevole.

Floor and wall lamp in extra clear curved glass in gold leaf finish. Metal frame in Corten finish. Vertical detail in burnished brass finish with LED lighting system. Floor lamp with swivelling base.



ILLUMINAZIONE / LIGHTING

PLISSE' PIANTANA

Disegno Diana Zabarella e Reflex

Piantana in vetro di Murano plissettato bianco incamiciato con giunzione in metallo lucido. Impianto luce a LED.

Floor lamp in 'plissé' Murano glass, white coated finish with junction in shiny metal. Lighting system with LED.



struttura • structure

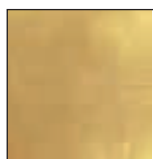

supporto • support



base • base

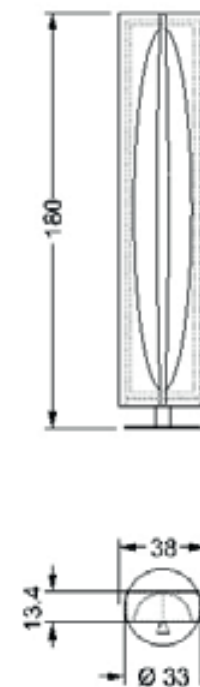
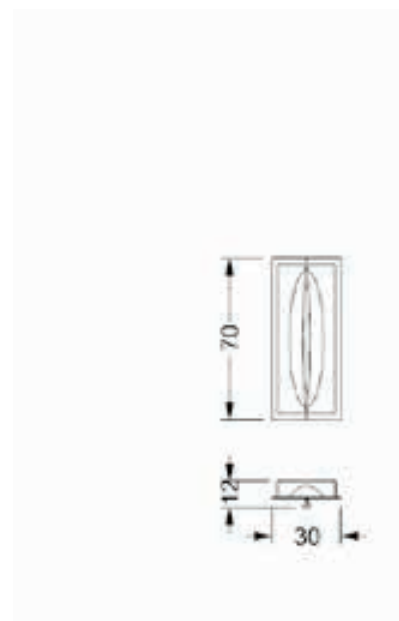
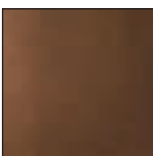

struttura • structure



LUCCIOLA PIANTANA

Disegno Reflex

Piantana con elemento centrale in vetro di Murano lavorato a mano disponibile in tre altezze, sabbiato all'estremità superiore. Base in vetro con finitura a specchio in sezione tonda o a mezzaluna. Impianto luce posizionato in basso a LED

Floor lamp with central rod in handmade Murano glass frosted on the top, available in 3 different heights. Round or half-moon-shaped base in mirror finish. LED lighting system

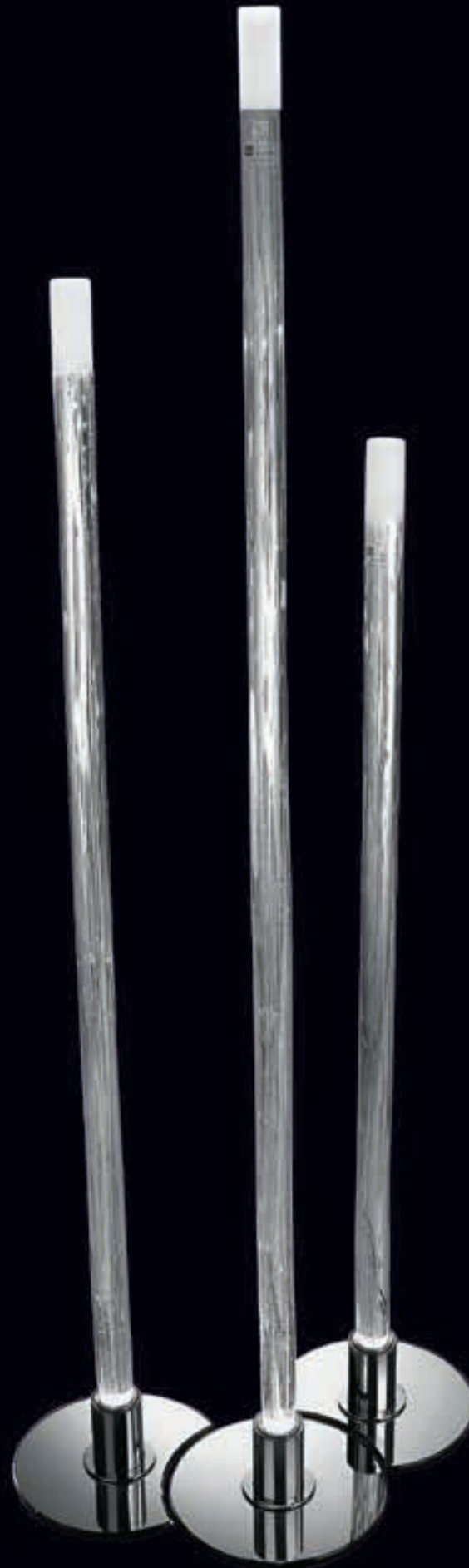

base • base



supporti • support

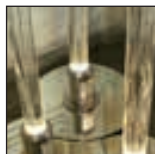

reflex
GLAMOUR

O G G E T T I

O B J E C T S

- 413 CALCEDONIO
- 411 MING
- 409 TAIYO *appendiabiti*
- 414 VASI MURANO
- 408 VASI RIGATI

OGGETTI

VASI RIGATI

Disegno Reflex

Vasi in vetro di Murano rigato disponibili in diversi colori e forme.

Vases in ribbed Murano glass, available in various colours and shapes.



OGGETTI

TAIYO APPENDIABITI

Disegno Tulczinsky

Appendiabiti in cristallo temperato trasparente o extrachiaro sabbiato con sfera di giunzione cromata e particolari in alluminio lucidato.

Clothes stand in tempered transparent glass or extra clear sandblasted glass, with chromed junction sphere and details in polished aluminium.



VASI RIGATI

FINITURE • FINISHES

SCHEDA TECNICA • TECHNICAL DRAWINGS

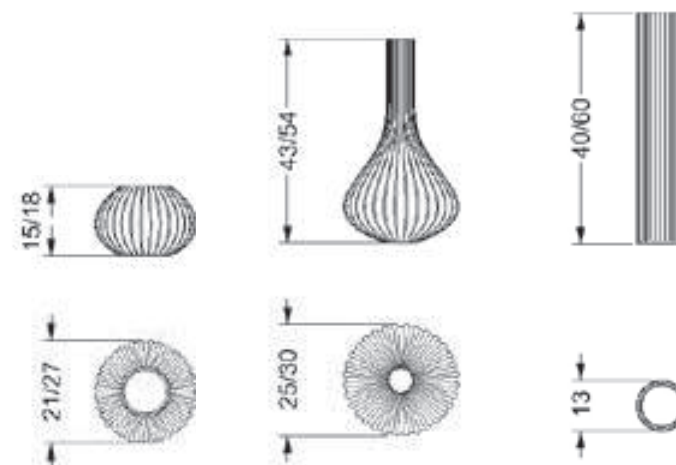
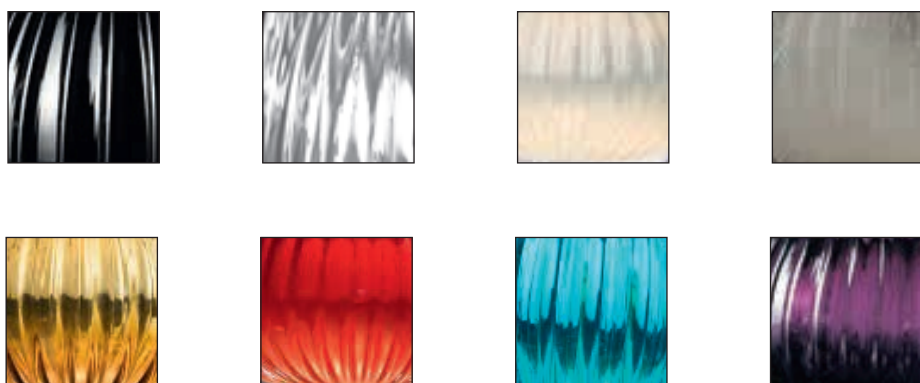

TAIYO APPENDIABILI

FINITURE • FINISHES

SCHEDA TECNICA • TECHNICAL DRAWINGS

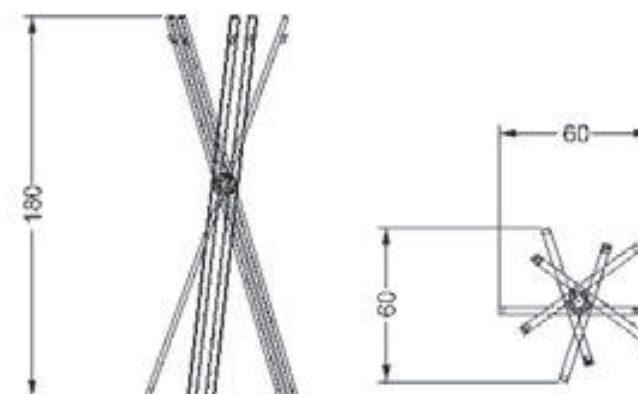

OGGETTI

MING

Disegno Tulczinsky

Vaso in vetro di Murano disponibile nei colori blu, rosso, ambra, nero, bianco acidato, bianco incamiciato o trasparente.
Base rotonda a specchio.
Disponibile versione con luce.

Vase in blue, red, amber, black, etched white coated or transparent Murano glass, with round mirror base. Available also with lighting.



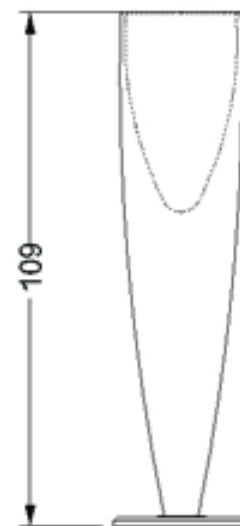
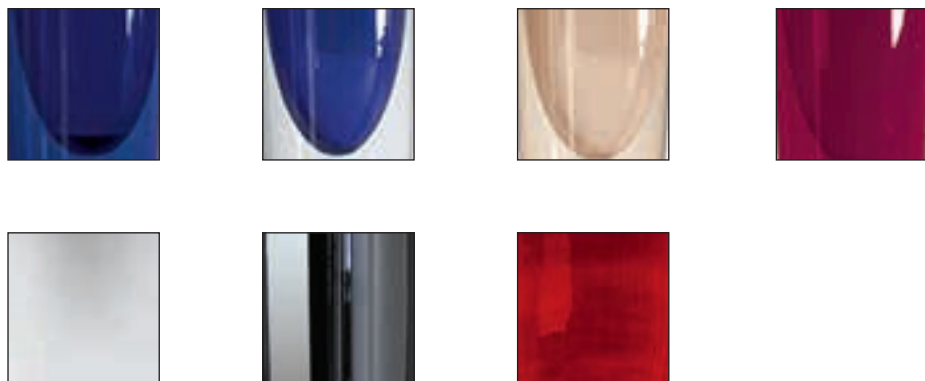

OGGETTI

CALCEDONIO

Disegno Reflex

Vasi in vetro di Murano finitura Calcedonio.

Vases in Murano glass in Calcedonio finish.



OGGETTI

VASI MURANO

Disegno Reflex

Collezione di vasi e piatto in vetro di Murano multicolore eseguiti con tecnica di lavorazione Striato.

Collection of vases and plate in multi-coloured Murano glass in Striato technique.



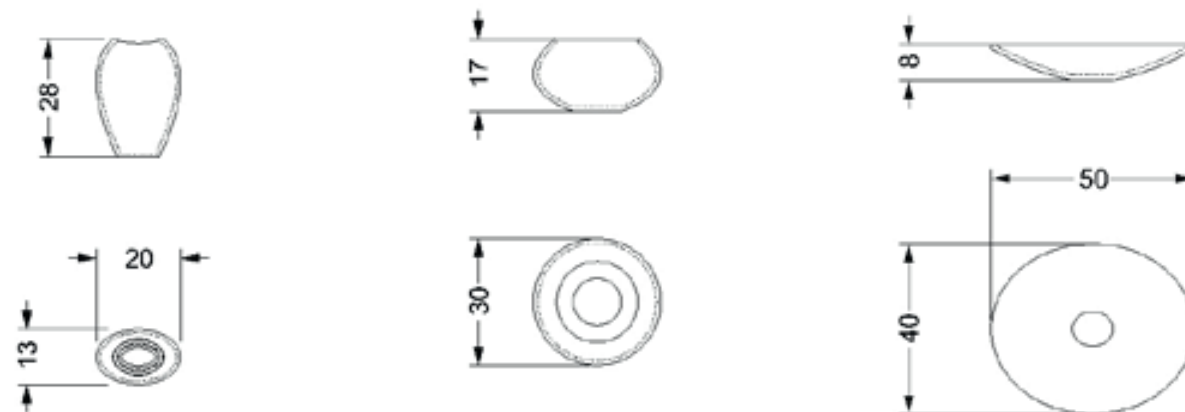
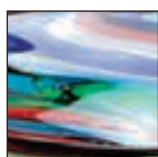
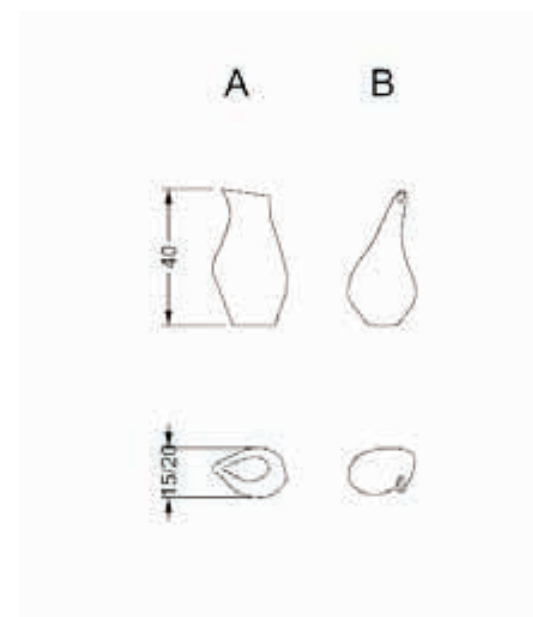



G L A M O U R

Reflex Showroom Milano

Via Madonnina, 17
20121 (Brera) Milano - Italy
T +39 02 80582955
spacereflex@reflexangelo.com

Reflex Headquarter

Via Paris Bordone 78/80
31030 Biadene - Treviso - Italy
T +39 0422 8444
+39 0422 844430 (ufficio estero)
+39 0422 844440 (ufficio Italia)
info@reflexangelo.com

Reflex Showroom Treviso

Via D'Annunzio, 77
31030 Biadene - Treviso - Italy
T +39 0422 844440

Reflex Showroom Berlino

Taubenstrasse 26
D-10117 Berlin
T. +49 30 20888705
berlin@reflexangelo.com

www.reflexangelo.com
info@reflexangelo.com

reflex

reflexangelo.com