

PINTI *buffet*
★★★★★
made in
Italy

product manager
Ruggero Borghetti

fotografo
Claudio Sambinelli

graphic designer
Elena Maccabiani

*si ringrazia
il ristorante
La Cantinaccia
a Brescia per
l'ospitalità nelle foto
ambientate.*

cod. catalogo
98900462

2018

PINTI *buffet*
made in
Italy

Pinti Inox S.P.A.
Via Antonini 87
25068 Sarezzo (BS)
Italia
Tel. +39 030 89351
Fax +39 030 8935250
+39 030 8901163
www.pinti.it
pintinox@pinti.it

**Pinti Inox GmbH
Deutschland**
Römerstraße 91
73066 UHINGEN
Tel. +49 07161 93343-0
Fax +49 07161 352789
www.pinti.de
muehlmeier@pinti.de



2018
★★★★★
made in
Italy



PINTI *buffet*
★★★★★
5stelle

→ Caldi Heating.....8
→ Freddi Refrigerating systems.....18
→ Neutri Neutral.....40
→ Distributori Dispensers.....62

PINTI *buffet*
CLASSIC

→ Caldi Heating.....73
→ Freddi Refrigerating systems.....75
→ Neutri Neutral.....80
→ Distributori Dispensers.....85

CARRELLI

→ Serving trolley.....88

SHOW FOOD

→ Show Food.....100

PINTI *buffet*
COMPACT

→ Compact Buffet.....114

SERIE ASTRA

→ Astra Tools.....128

MOLLE

→ Tongs.....134

PINTI *buffet*
trendybar

→ Caldi Heating.....142
→ Neutri Neutral.....144
→ Freddi Refrigerating systems.....160

COMPONENTI

→ Components.....165

NOTE INFORMATIVE

→ Technical information on components180



Buffet

La linea Buffet è l'elegante coordinato di oggetti destinati al libero servizio della moderna ristorazione.

Le Funzioni

- **PRESENTAZIONE:** favorisce una magnifica esposizione che esalta l'immagine della qualità dei cibi proposti.
- **CUPOLE:** proteggono i cibi da agenti esterni secondo le normative igieniche europee.
- **CALDO:** i chafing dishes mantengono i cibi ad una temperatura ottimale per la conservazione dei sapori .

Disponibile:

- Versione tradizionale: con fornelli inox adatti a contenere alcool gel.
- Versione optional: con resistenza elettrica amovibile con regolatore in 7 posizioni.
- Tutte le versioni prevedono un piano di protezione in acciaio 18/10.
- FREDDO:** ha lo scopo di mantenere i cibi ad una bassa temperatura, come mostrato dai grafici in ogni pagina. Il raffreddamento può avvenire
 - con rivoluzionari sacchetti gel, in dotazione, da raffreddare in freezer
 - con il ghiaccio (sistema tradizionale).



Buffet

The Buffet line elegantly coordinates the objects for the new presentation trend of self-service.

Its Functions

- **PRESENTATION:** to arrange things in an orderly fashion that magnifies the outlook of the offered foodstuff.
- **DOMELIDS:** preserve foodstuff from the outside according to European hygienic norms.
- **HEATING:** our Chafing dishes keep food at an optimum temperature to maintain their flavours.

Available in:

- A traditional version with burner holders that are suitable for alcohol gel.
- An option version with a demountable electric resistance to set in 7 different positions.

c) All executions are provided with 18/10 stainless steel border.

• **COOLING:** The aim is to keep food at a low temperature as per the specific graphs in each page. Cooling is carried out

- by revolutionary gel packs, supplied , to keep in freezer
- by ice (traditional system).



Buffet

La gamme Buffet Pinti est un élégant ensemble d'articles destinés au self service toujours plus diffusé dans la restauration moderne.

Fonctions

- **PRESENTATION:** le buffet Pinti favorise la présentation des plats et exalte la qualité
- **CLOCHES:** nos cloches protègent les aliments contre les agents pathogènes externes selon les normes d'hygiène européennes.
- **CHAUD:** les Chafing Dishes permettent de conserver les aliments à une température optimale pour la conservation du goût.

disponible:

- la version standard: avec des réchauds en acier, conçus pour contenir de l'alcool en gel
 - en option: avec résistance électrique amovible réglable (7 niveaux)
 - Toutes les versions sont maintenant renforcées avec une couverture en acier 18/10 du plan sur la partie supérieure de la base en MDF.
- FROID :** vise à garder les aliments à une basse température pour longtemps (voir graphiques temps-température aux pages dédiées à ces articles)
- Le refroidissement peut se faire
 - avec de nouveaux sachets en gel , qui doivent être refroidis dans un congélateur. Le sachets sont compris gratuitement dans les articles du buffet.
 - avec des glaçons (système traditionnel).



Buffet

Buffet ist die elegante Linie, die aufeinander abgestimmten Artikel nach den neuen Trends der Selbstbedienung

koordiniert.

Die Funktionen

- **BEHILFLICH ZUM SERVIEREN:** um Ordnung zu schaffen und die Qualität der angebotenen Speisen zu preisen.
- **ROLLTOP** beschützt von äußeren Einwirkungen, wie nach den europäischen Hygiene-Vorschriften.
- **HEISS:** unsere Chafingdishes halten die Speisen auf einer optimalen Temperatur zur Geschmackaufbewahrung. Erhältlich in :
 - Der traditionelle Version mit Edelstahlkocher entwickelt, um Alkohol-Gel zu enthalten.
 - Optional: mit abnehmbarem Widerstand.
 - Alle Versionen sind mit einem Stahl-top ausgestattet.
- **KALT:** um die Speisen kühler zu halten , wie nach Tabelle an der Seite. Die Abkühlung erfolgt :
 - mit den revolutionären inklusiven Kälteakku , im Gefrierschrank zu kühlen
 - mit dem Eis (traditionelle System).



Buffet

La línea Buffet es el resultado de una elegante coordinación de objetos destinados al autoservicio de la restauración moderna.

Las funciones

- **PRESENTACIÓN:** favorece una magnífica exposición que resalta la imagen de calidad de los alimentos expuestos.
 - **CÚPULAS:** protegen a los alimentos de agentes externos, siguiendo la normativa higiénica europea.
 - **CALOR:** los chafing dishes mantienen los alimentos a una temperatura óptima para la conservación de los sabores.
- Disponible:
- Versión tradicional: con hornillos inox adecuados para contener alcohol en gel.
 - Versión opcional: con resistencia eléctrica regulable a 7 posiciones.
 - Todas las versiones están provistas de un placa de protección en acero 18/10.
- **FRÍO:** tiene el objetivo de mantener los alimentos a baja temperatura, tal y como muestran los gráficos de cada una de las páginas. El enfriamiento puede alcanzarse:
 - con las revolucionarias bolsas de gel, previo enfriamiento en el congelador
 - con hielo (sistema tradicional).

immagine
prodotto
item
picture

descrizione
prodotto
item
description

adatto al contatto alimentare
secondo *decreto legislativo*
DL 108 dt 25.01.92 e Dir. CEE
1935/2004 e 89/109
suitable to food contact
according to ministerial decree
D.L. 108 dd 25.01.92 and Dir.
EEC 1935/2004 and 89/109

codice articolo Pinti
Pinti's item code

codice Ean
bar code

distributore
manufacturer
o distributor

numero lotto per
tracciabilità
manufacturing lot
control number for
tracking process

adatto al
lavaggio in
lavastoviglie
dishwasher safe

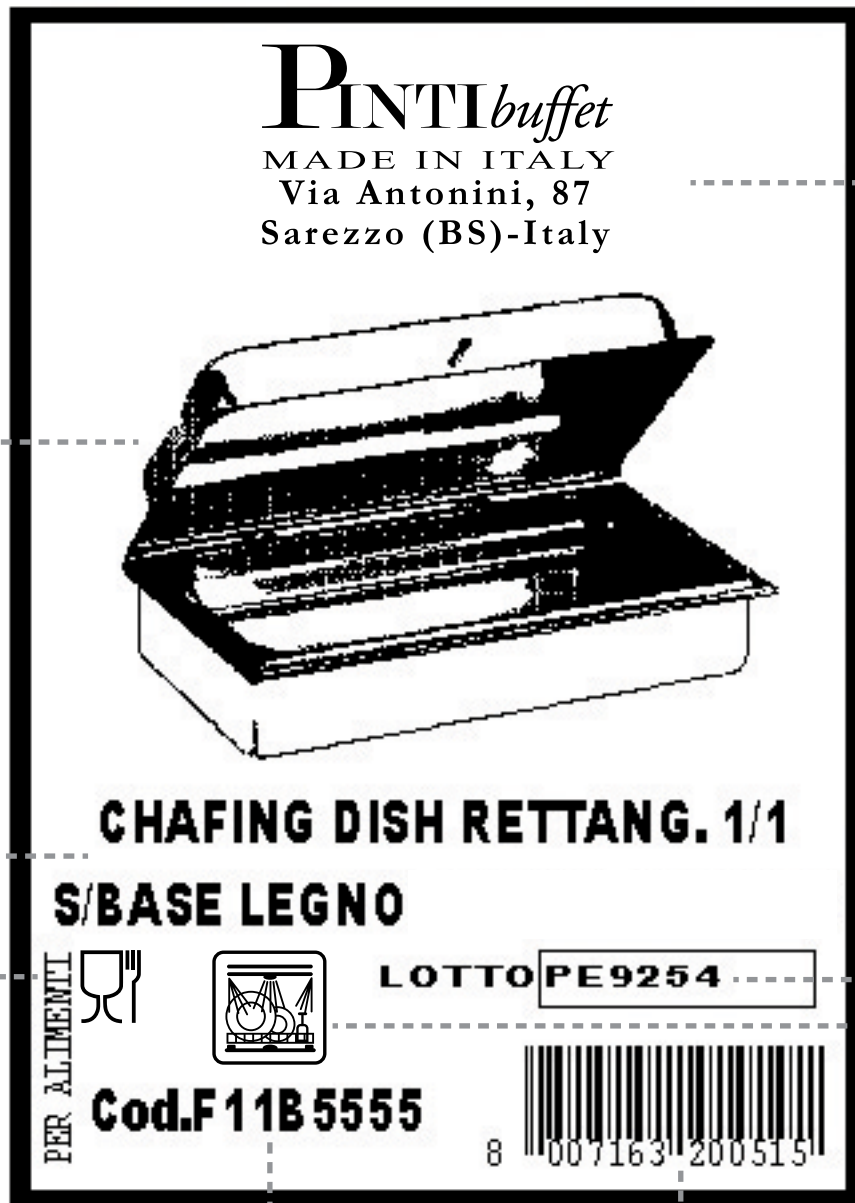

★★★★★
made in
Italy

PINNI *buffet*





Buffet 5 stelle

Destinato a buffet moderni e di tendenza.

La laccatura bianca, ad alta resistenza, è ideale per ambienti raffinati e di alto livello.

Il Buffet 5 stelle è realizzato con materiali certificati, adatti agli alimenti, è di facile manutenzione e pulizia.

I Caldi sono tutti protetti da una piano in acciaio e sono caratterizzati da una chiusura a frizione.



Buffet 5 stelle

Dedicated to modern buffet and according to the latest presentation trends.

The highly resistant white lack outlook fits well to elegant and high level settings.

Buffet 5 stelle materials are certified , suitable for foodstuff ,easy to use and to clean.

I Caldi are all provided with a stainless steel border and friction closing.



Buffet 5 stelle

Destiné aux buffet modernes et branchés.

Le vernis laqué blanc, de haute résistance, est idéal pour des milieux raffinés et de haut niveau.

Le buffet 5 Etoiles est fait avec des matériaux certifiés, adaptes au contacte alimentaire, il est facile à entretenir et à nettoyer.

Les pièces réchauffées sont toutes protégées par une plaque

d'acier et sont caractérisées par une fermeture des couvercles à friction pour rendre la fermeture silencieuse.



Buffet 5 stelle

An moderne und trendige Buffet gewidmet der weiße Lack, hohe Festigkeit, ist ideal für raffinierte Aufstellungen von hoher Qualität.

Die Materialien von Buffet 5 stelle sind zertifiziert, für Lebensmittel geeignet einfache Wartung und Reinigung.

I Caldi sind alle durch eine Stahlplatte geschützt und durch eine Sperrkupplung gekennzeichnet.



Buffet 5 stelle

Destinado a buffets modernos i de tendencia.

El lacado blanco, de alta resistencia, es ideal para ambientes lujosos y de alto nivel.

El Buffet 5 estrellas ha sido realizado con materiales certificados, adecuados a los alimentos, y de fácil mantenimiento y limpieza.

Todos aquellos elementos destinados a mantener el calor, están protegidos por una placa de acero, y se caracterizan por su cierre a fricción.



Caldi

I Caldi Buffet sono montati su strutture in MDF caratterizzate da tre lati chiusi e uno aperto, per facilitare l'aerazione.

The Heating Systems Buffet are mounted on MDF structures with three closed sides and one open side for better ventilation.

I Caldi Buffet grazie ai fornelli in inox in dotazione mantengono costante la temperatura degli alimenti.

Optional: è disponibile la resistenza elettrica di facile applicazione.

I Caldi Buffet keep the food temperature steady by means of the supplied stainless steel burner holders.

Optional: an adjustable heater is optional.

I Caldi Buffet mantengono una temperatura regolabile tra i 65° e 80°C.

Ciò arresta la crescita batterica e addirittura oltre i 60°C micro-organismi patogeni vengono progressivamente eliminati rendendo il cibo batteriologicamente sicuro.

I Caldi Buffet keep a food temperature which can be adjusted between 65° and 80°C, thus stopping the bacterial growth: at these temperatures dangerous bacteria are eliminated and the food is safe.

MANTENENDO LA TEMPERATURA AL DI SOPRA DEI 60°C, SI ELIMINA QUALISIASI RISCHIO DI SALMONELLOSI.

BY KEEPING TEMPERATURE ABOVE 60°C, THERE IS NO RISK FOR SALMONELLOSIS.



Diagramma della proliferazione batterica in base alla temperatura

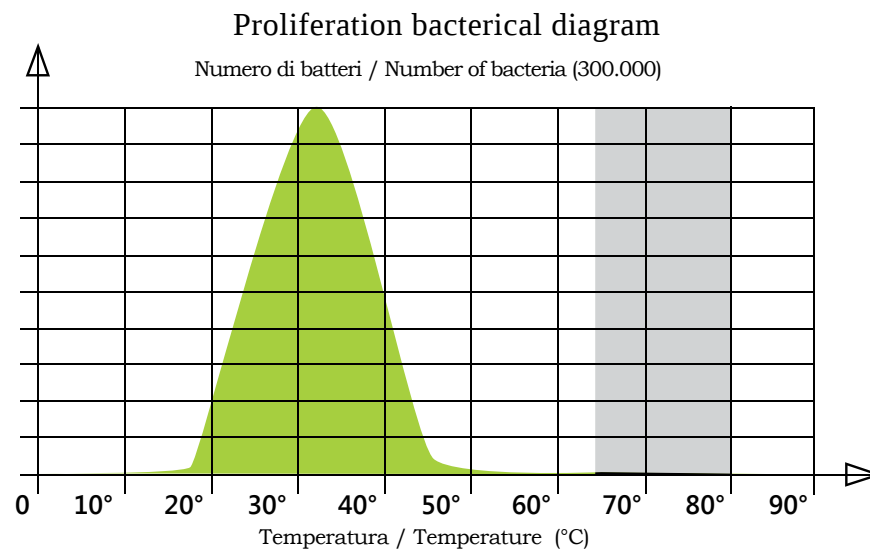

Composizione

Cod. D05B5559

- 1 VASCA BAGNOMARIA 1/1
h110

Gastronorm bain marie basin
Bac de bain-marie GN
Wasserbad-Wanne GN
Recipiente baño-maría GN

Cod. D05B5558

- 1 COPERCHIO RETT. GN C/
POMOLO

GN lid with knob

Couvercle GN avec pommeau et
Gastronorm deckel mit Knopf
Tapa gastronómica GN con pomo

Cod. 5BA11065

- 1 BACINELLA GN 1/1 h 65

Gastronorm basin
Bac gastronorm
Durchbrochener basis
Cubeta gastronómica

Cod. 97200078

- 2 FORNELLETTI INOX

Stainless steel burner holder
Fourneau

Kocher

Quemadores

Cod. 97200089

- 2 SUPPORTI PER

FORNELLETTI INOX

Holder for stainless steel burner
Support pour réchaud en acier
inoxydable

Halterung für Edelstahlkocher

Soporte para hornillo inox

Cod. 9715B752

- 1 BASE ALTA IN MDF

C/PIANO IN ACCIAIO

High stand with steel border
Base haute avec protection en acier

Hoher Sockel mit Edelstahlrand

Base alta con plancha super. en acero

Optional

IL CHAFING DISH È PREDISPOSTO
PER L'INSERIMENTO DELLA
RESISTENZA ELETTRICA
CON REGOLATORE

Cod. 97150118

230 Volt 700 Watt

The chafing dish can use a heater.

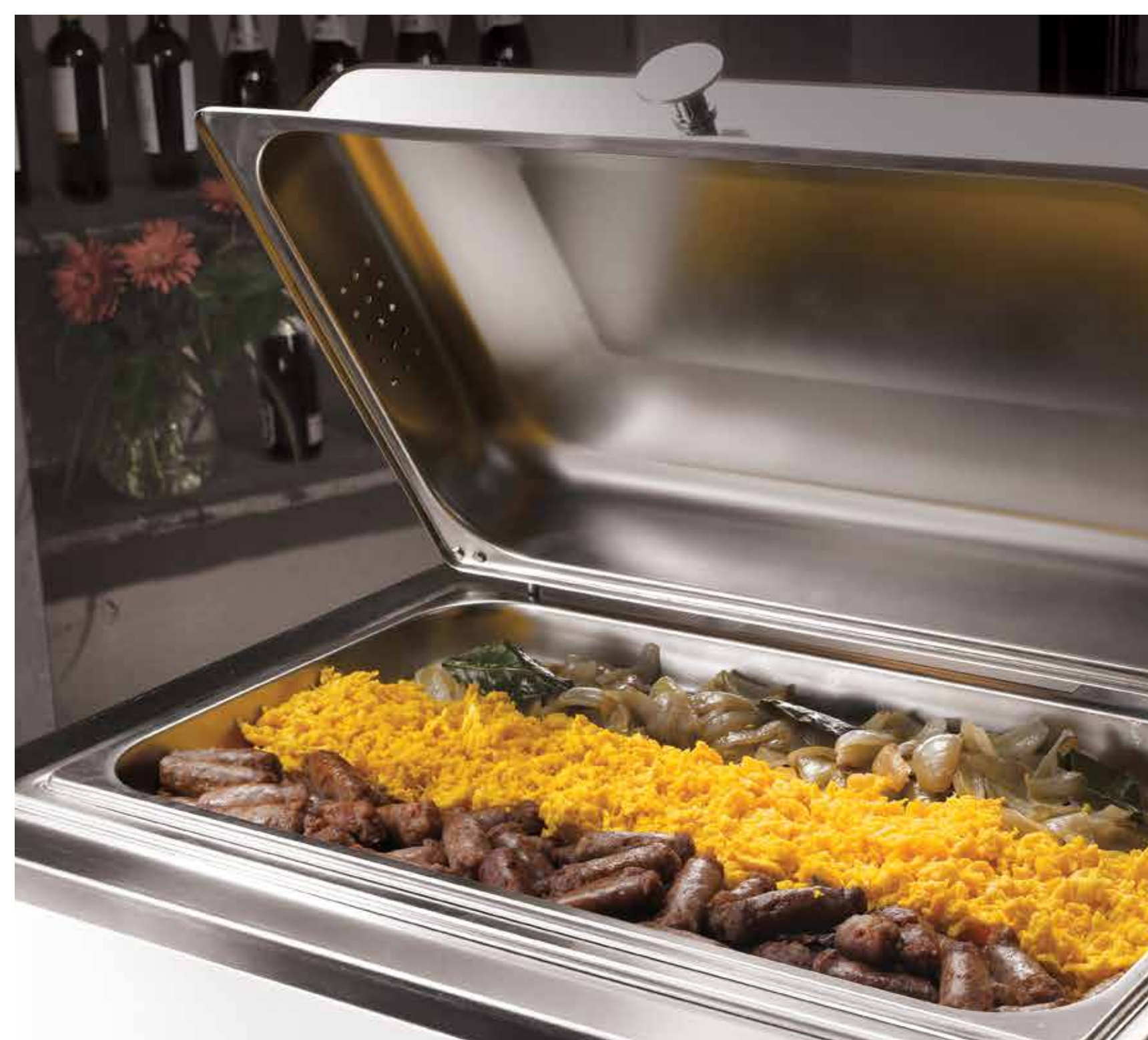



Chafing dish rettangolare GN 1/1 con chiusura a frizione

Cod. 511B5555

GN complete rectangular chafing dish 1/1 friction closing.

Chafing Dish rectangulaire gn 1/1 avec fermeture à friction.

Chafing Dish rechteckig GN 1/1 komplett mit Kupplungsschliessung.

Cubeta GN 1/1 con cierre con fricción.

Diagramma del mantenimento della temperatura

Temperature maintenance diagram - Diagramme de maintien de la température
Diagramm zur Temperaturerhaltung - Diagrama de mantenimiento de la temperatura

Temperatura / Temperature / Température / Temperatur / Temperá (°C)

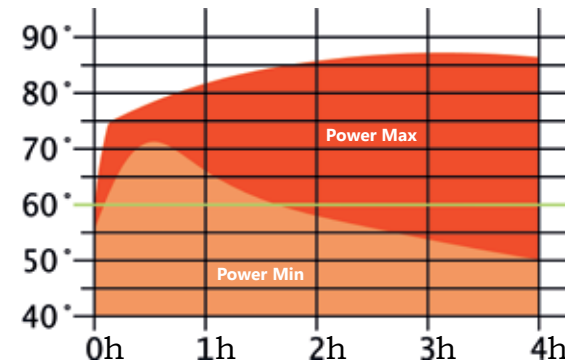

Tempo / Time / Temps / Zeit / Tiempo (h)

Al di sopra dei 60°C si elimina qualsiasi rischio di salmonellosi.

Above 60°C, there is no risk for salmonellosis.

Au-dessus de 60°C le risque de salmonellose est éliminé.

Oberhalb von 60°C beseitigt man jegliches Risiko von Salmonelleninfektion.

Por encima de los 60°C, se elimina cualquier riesgo de salmonelosis.

Composizione

Cod. D0595559

- 1 VASCA BAGNOMARIA 1/1
h110 C/GANCI
Gastronorm bain marie basin
Bac de bain-marie GN
Wasserbad-Wanne GN
Recipiente baño-maria GN

Cod. 30595557

- 1 COPERCHIO
PORTA ZUPPIERA GN
GN lid for soup bowl
Couvercle pour soupière GN
Deckel für Suppenschüsselhalter GN
Tapa porta-sopera GN

Cod. 30597222

- 2 ZUPPIERE lt. 5
Soup bowl
Soupière
Suppenschüssel
Sopera

Cod. 30877522

- 2 COPERCHI ZUPPIERA cm. 22
Lid
Couvercle
Deckel
Tapa

Cod. 97200078

- 2 FORNELLETTI INOX
Stainless steel burner holder
Fourneau
Kocher
Quemadores

Cod. 97200089

- 2 SUPPORTI PER
FORNELLETTI INOX
Holder for stainless steel burner
Sup. pour réchaud en acier inoxydable
Halterung für Edelstahlkocher
Soporte para hornillo inox

Cod. 9715B752

- 1 BASE ALTA IN MDF
C/PIANO IN ACCIAIO
High stand with steel border
Base haute avec protection en acier
Hoher Sockel mit Edelstahlrand
Base alta con plancha superior en acero

Optional

- LA ZUPPIERA È PREDISPOSTA
PER L'INSERIMENTO DELLA
RESISTENZA ELETTRICA
CON REGOLATORE

Cod. 97150118

230 Volt 700 Watt

The soup bowl can use a heater.





Zuppiera 2 stazioni riscaldata

Cod. 511B5556

2 Heated soup bowls.

Soupière a 2 stations.

Suppenstation.

Sopera 2 staciones.

Diagramma del mantenimento della temperatura

Temperature maintenance diagram - Diagramme de maintien de la température
Diagramm zur Temperaturerhaltung - Diagrama de mantenimiento de la temperatura

Temperatura / Temperature / Température / Temperatur / Temperá (°C)

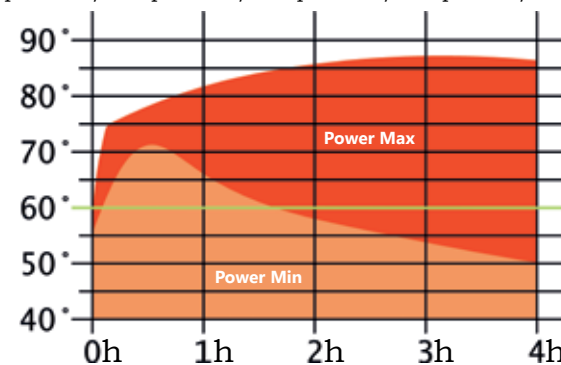

Tempo / Time / Temps / Zeit / Tiempo (h)

— Al di sopra dei 60°C si elimina qualsiasi rischio di salmonellosi.

Above 60°C, there is no risk for salmonellosis.

Au-dessus de 60°C le risque de salmonellose est éliminé.

Oberhalb von 60°C beseitigt man jegliches Risiko von Salmonelleninfektion.

Por encima de los 60°C, se elimina cualquier riesgo de salmonelosis.



Composizione

Cod. D05B5559

1 VASCA BAGNOMARIA 1/1
h110

Gastronorm bain marie basin
Bac de bain-marie GN
Wasserbad-Wanne GN
Recipiente baño-maría GN

Cod. D05B5558

1 COPERCHIO RETT. GN C/
POMOLO

GN lid with knob
Couvercle GN avec pommeau
Gastronorm deckel mit Knopf
Tapa gastronómica GN con pomo

Cod. 5BA28065

4 BACINELLE GN 2/8 h 65

Gastronorm basin
Bac gastronorm
Durchbrochener basis
Cubeta gastronómica

Cod. 97200078

2 FORNELLETTI INOX

Stainless steel burner holder
Fourneau
Kocher
Quemadores

Cod. 97200089

2 SUPPORTI PER

FORNELLETTI INOX
Holder for stainless steel burner
Support pour réchaud en acier
inoxydable

Halterung für Edelstahlkocher
Soporte para hornillo inox

Cod. 9715B752

1 BASE ALTA IN MDF

C/PIANO IN ACCIAIO
High stand with steel border
Base haute avec protection en acier
Hoher Sockel mit Edelstahlrand

Base alta con plancha superior en acero

Optional

IL PORTA VERDURE
È PREDISPOSTO PER
L'INSERIMENTO DELLA
RESISTENZA ELETTRICA
CON REGOLATORE

Cod. 97150118

230 Volt 700 Watt

The basin for vegetables can use a heater.



Porta verdure 4 scomparti riscaldato con chiusura a frizione

Cod. 511B2810

4 complete heating basin for vegetables friction closing.

Porte-aliments pour légumes, 4 compartiments complet réchauffé et fermeture à friction.

Halter für Gemüseschalen 4-fach, komplett, beheizt mit Kupplungsschliessung.

Porta-verduras con 4 compartimentos completo calentado con cierre con fricción.

Diagramma del mantenimento della temperatura

Temperature maintenance diagram - Diagramme de maintien de la température
Diagramm zur Temperaturerhaltung - Diagrama de mantenimiento de la temperatura

Temperatura / Temperature / Température / Temperatur / Temperá (°C)

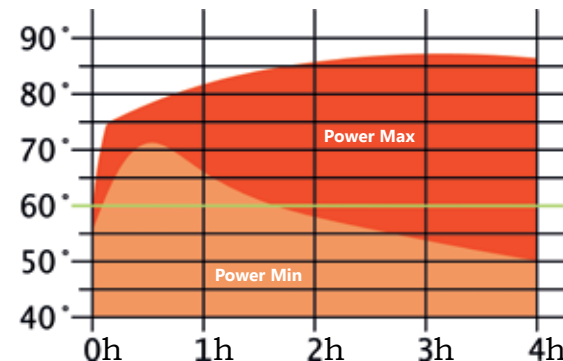

Tempo / Time / Temps / Zeit / Tiempo (h)

— Al di sopra dei 60°C si elimina qualsiasi rischio di salmonellosi.

Above 60°C, there is no risk for salmonellosis.

Au-dessus de 60°C le risque de salmonellose est éliminé.

Oberhalb von 60°C beseitigt man jegliches Risiko von Salmonelleninfektion.

Por encima de los 60°C, se elimina cualquier riesgo de salmonelosis.

Componentistica: vedi pag. / Technical card: see page / Fiches techniques: voir page / Technische karten: Siehe Seite / Tarjetas tecnicas: ver pagina 166

Note Informativa: vedi pag. / Technical information: see page / Notes d'information: voir page / Hinweise teile: Siehe Seite / Notas informativas: ver pagina 180

Acciaio Inossidabile 18/10 & MDF / Stainless steel 18/10 & MDF / Acier 18/10 & MDF / Edelstahl 18/10 & MDF / Acero 18/10 & MDF

Composizione

Cod. FBAG1120

1 BACINELLA 1/1 h 20
C/FORCELLE E GANCI

Basin with hooks

Bac avec crochets

Schüssel mit Aufnahmegabeln für Haube

Cuenco c/asas

Cod. H095B953

1 TEGLIA GN 1/1 h40
C/SPACCO

GN basin with slot

Plat avec fente

Blech GN mit Schlitz

Fuente GN poco profunda

Cod. 5FF11000

1 FALSO FONDO FORATO GN 1/1
Perforated GN False bottom

Faux fond percé PC

Gelochter falscher Boden PC

Doble fondo perforado PC

Cod. 97150770

1 RESISTENZA ELETTRICA
230V 40 W

Electrical resistance

Resistance électrique

Elektrischer Widerstand

Resistencia eléctrica

Cod. 97150112

1 CUPOLA RETT. APRIBILE PC
Rectangular dome lid

Cloche rectangulaire

Rolltop

Campana rectangular

Cod. 9715B752

1 BASE ALTA IN MDF
C/PIANO IN ACCIAIO

High stand with steel border

Base haute avec protection en acier

Hoher Sockel mit Edelstahlrand

Base alta con plancha superior en acero



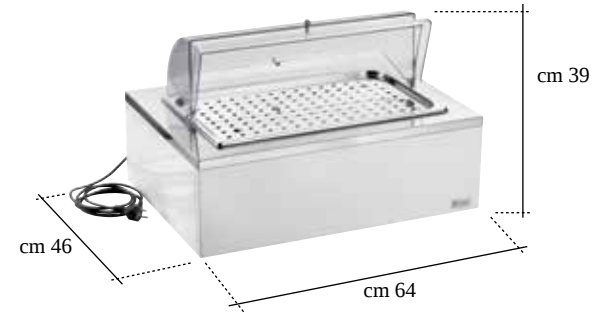

Vassoio per brioches riscaldato con resistenza elettrica

230 Volt 40 Watt

Cod. 511B0930

Heating perforated tray with cover for brioche provided with electrical resistance.

Plateau chauffant pour viennoiseries avec résistancé électrique.

Rechteckiges warmhalte-tablett für brioches ausgestattet.

Bandeja de calentamiento para bollería con resistencia elètrica.

Diagramma del mantenimento della temperatura

Temperature maintenance diagram - Diagramme de maintien de la température
Diagramm zur Temperaturerhaltung - Diagrama de mantenimiento de la temperatura

Temperatura / Temperature / Température / Temperatur / Temperà (°C)

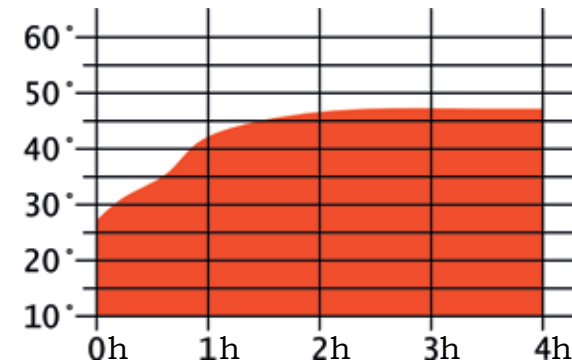

Tempo / Time / Temps / Zeit / Tiempo (h)

— Al di sopra dei 60°C si elimina qualsiasi rischio di salmonellosi.

Above 60°C, there is no risk for salmonellosis.

Au-dessus de 60°C le risque de salmonellose est éliminé.

Oberhalb von 60°C beseitigt man jegliches Risiko von Salmonelleninfektion.

Por encima de los 60°C, se elimina cualquier riesgo de salmonelosis.



Freddi

I Refrigeranti Buffet grazie alle glaccette incluse oppure al ghiaccio mantengono una bassa temperatura dei cibi impedendo ai batteri di deteriorare gli alimenti.

I Refrigeranti Buffet keep the food temperature low by means of the supplied refrigerating bricks thus preventing bacteria to contaminate the food.



Come mostra il grafico a lato, i batteri sviluppano la loro attività nella zona verde, pertanto i Refrigeranti Buffet aiutano il mantenimento dei cibi in una zona di sicurezza compresa tra 4° e i 15°C.

Looking at the diagram, bacteria proliferate in the green area; Pintinox Refrigeranti Buffet keep the food temperature in a safe temperature between 4° and 15 ° C.

MANTENENDOLA TEMPERATURA AL DISOTTO DEI 10°C, RALLENTA LA PROLIFERAZIONE BATTERICA.

KEEP FOOD TEMPERATURE BELOW 10° TO PREVENT BACTERIA PROLIFERATION.

Diagramma della proliferazione batterica in base alla temperatura

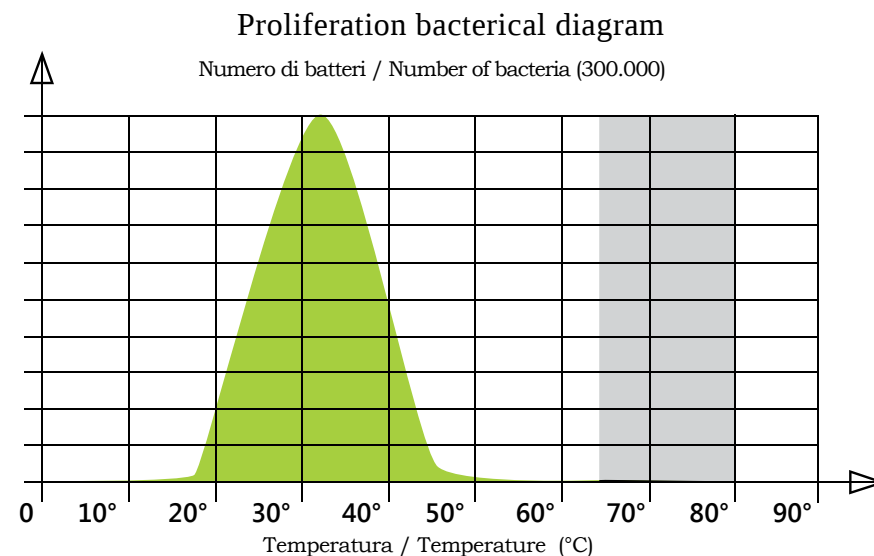

Composizione

Cod. **FBAF1220**

1 VASSOIO PORTA UOVO
GN 1/2 C/FORCELLA
Egg tray with hooks
Oeufrier avec crochets
Eier-Tablett mit Aufnahmegabeln für
Haube

Bandeja porta-huevos c/asas

Cod. **FBFF1240**

1 BACINELLA GN 1/2 h 40
FORATA C/FORCELLA
Perforated basin with hooks
Bac percé avec crochets
Eier-Tablett mit Aufnahmegabeln für
Haube

Cuenco perforado c/asas

Cod. **5BP12065**

2 BACINELLE GN PC 1/2 h 65
PC Gastronorm basin
Bac gastronorm PC
Durchbrochener basis PC
Cubeta gastronormic PC

Cod. **5FP12000**

2 FALSI FONDI FORATI GN PC 1/2
Perforated false bottom
Faux fond percé PC

Gelochter falscher Boden PC

Doble fondo perforado PC

Cod. **97150276**

4 GEL PACK cm. 20x9,8
Refrigerating brick
Briquette réfrigérante
Kühlakku
Refrigerado

Cod. **97150112**

1 CUPOLA RETT. APRIBILE PC
Rectangular dome lid
Cloche rectangulaire
Rolltop

Campana rectangular

Cod. **9715B751**

1 BASE BASSA IN MDF
Low base
Base basse
Niedrigen Basis
Base baja





Doppio vassoio porta uovo e verdure a doppia parete refrigerato

Cod. 511B2830

Double wall refrigerated GN tray with cover for eggs and vegetables.

Double plateau GN réfrigérant à double paroi avec cloche pour œufs et légumes.

Doppeltes Eier- und Gemüsetablett GN, doppelwandig, gekühlt mit Haube.

Bandeja doble GN porta-huevos y verduras con doble pared refrigerada con campana.

Diagramma del mantenimento della temperatura

Temperature maintenance diagram - Diagramme de maintien de la température
Diagramm zur Temperaturerhaltung - Diagrama de mantenimiento de la temperatura

Temperatura / Temperature / Température / Temperatur / Temperá (°C)

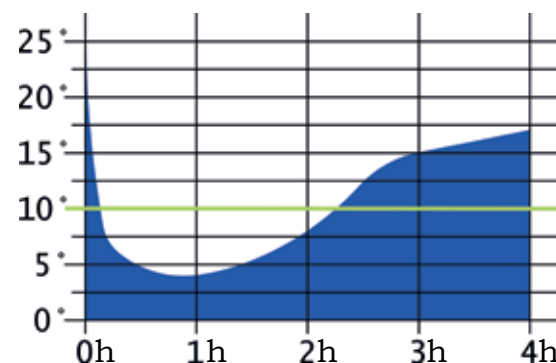

Tempo / Time / Temps / Zeit / Tiempo (h)

— Al di sopra dei 60°C si elimina qualsiasi rischio di salmonellosi.

Above 60°C, there is no risk for salmonellosis.

Au-dessus de 60°C le risque de salmonellose est éliminé.

Oberhalb von 60°C beseitigt man jegliches Risiko von Salmonelleninfektion.

Por encima de los 60°C, se elimina cualquier riesgo de salmonelosis.

Componentistica: vedi pag. / Technical card: see page / Fiches techniques: voir page / Technische karten: Siehe Seite / Tarjetas técnicas: ver pagina 166

Note Informativa: vedi pag. / Technical information: see page / Notes d'information: voir page / Hinweise teile: Siehe Seite / Notas informativas: ver pagina 180

Acciaio Inossidabile 18/10 & MDF / Stainless steel 18/10 & MDF / Acier 18/10 & MDF / Edelstahl 18/10 & MDF / Acero 18/10 & MDF

Composizione

Cod. FBAF1120

1 BACINELLA GN 1/1 h 20

C/FORCELLE

Basin with hooks

Bac avec crochets

Schüssel mit Aufnahmegabeln für

Haube

Cuenco c/asas

Cod. 5T111040

1 TEGLIA GN 1/1 h 40

Gastronorm basin

Plat gastronorm

Durchbrochener blech

Fuente gastronormic

Cod. 5FP11000

1 FALSO FONDO FORATO PC

Perforated PC false bottom

Faux fond percé PC

Gelochter falscher Boden PC

Doble fondo perforado PC

Cod. 97150276

4 GEL PACK cm. 20x9,8

Refrigerating brick

Briquette réfrigérante

Kühlakku

Refrigerado

Cod. 97150112

1 CUPOLA RETT. APRIBILE PC

Rectangular dome lid

Cloche rectangulaire

Rolltop

Campana rectangular

Cod. 9715B751

1 BASE BASSA IN MDF

Low base

Base basse

Niedrigen Basis

Base baja



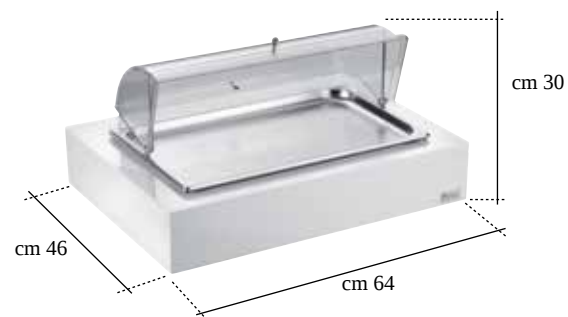

Vassoio per affettati refrigerato

Cod. 511B0950

Rectangular refrigerated tray with cover for sliced salami.

Plateau rectangulaire réfrigérant avec cloche pour charcuterie.

Rechteckiges Tablett für gekühlten Aufschnitt mit Haube.

Bandeja rectangular para fiambre en lonchas refrigerado con campana.

Diagramma del mantenimento della temperatura

Temperature maintenance diagram - Diagramme de maintien de la température
Diagramm zur Temperaturerhaltung - Diagrama de mantenimiento de la temperatura

Temperatura / Temperature / Température / Temperatur / Temperá (°C)

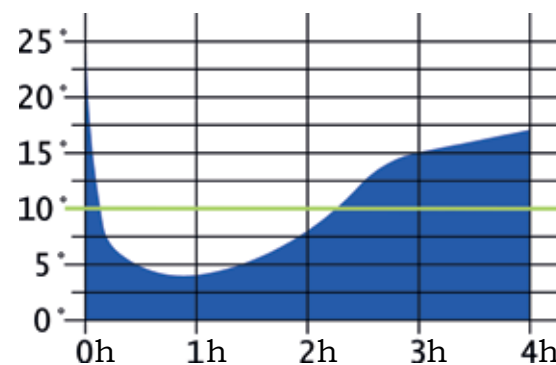

Tempo / Time / Temps / Zeit / Tiempo (h)

— Al di sopra dei 60°C si elimina qualsiasi rischio di salmonellosi.

Above 60°C, there is no risk for salmonellosis.

Au-dessus de 60°C le risque de salmonellose est éliminé.

Oberhalb von 60°C beseitigt man jegliches Risiko von Salmonelleninfektion.

Por encima de los 60°C, se elimina cualquier riesgo de salmonelosis.

Composizione

Cod. 5BA11040

1 BACINELLA GN 1/1 h 40

Gastronorm basin

Bac gastronorm

Durchbrochener basis

Cubeta gastronómica

Cod. F11F3310

1 VASSOIO PORTABURRO

C/FORCELLA

Butter tray with hooks

Plateau pour beurre avec crochets

Butter-Tablett mit Aufnahmegabeln für

Haube

Mantequillera c/asas

Cod. 5FP11000

1 FALSO FONDO FORATO PC

Perforated PC false bottom

Faux fond percé PC

Gelochter falscher Boden PC

Doble fondo perforado PC

Cod. 97150276

4 GEL PACK cm. 20x9,8

Refrigerating brick

Briquette réfrigérante

Kühlakku

Refrigerado

Cod. 97150112

1 CUPOLA RETT. APRIBILE PC

Rectangular dome lid

Cloche rectangulaire

Rolltop

Campana rectangular

Cod. 9715B751

1 BASE BASSA IN MDF

Low base

Base basse

Niedrigen Basis

Base baja



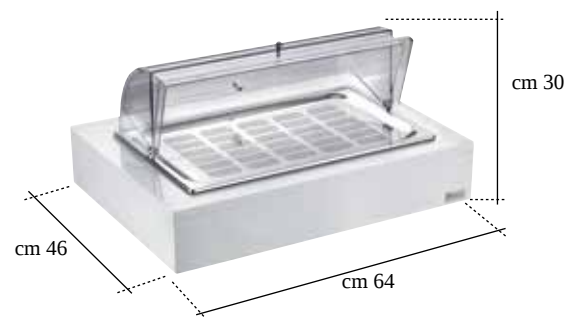

Vassoio forato porta burro e marmellata refrigerato

Cod. 511B3100

Perforated and refrigerated tray with cover for jam and butter.

Plateau percé réfrigérant avec cloche pour beurre et confiture.

Gelochtes Butter- und Marmelade-Tablett, gekühlt mit Haube.

Bandeja perforada para mantequilla y mermelada refrigerada con campana.

Diagramma del mantenimento della temperatura

Temperature maintenance diagram - Diagramme de maintien de la température
Diagramm zur Temperaturerhaltung - Diagrama de mantenimiento de la temperatura

Temperatura / Temperature / Température / Temperatur / Temperá (°C)

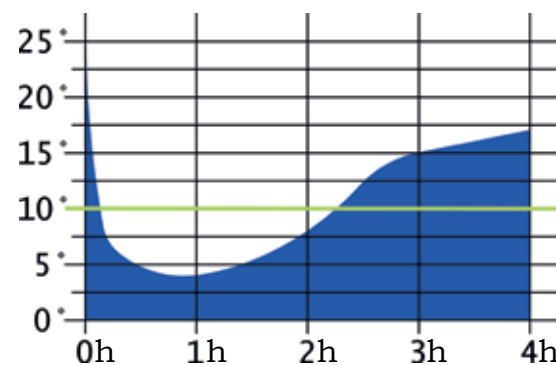

Tempo / Time / Temps / Zeit / Tiempo (h)

— Al di sopra dei 60°C si elimina qualsiasi rischio di salmonellosi.

Above 60°C, there is no risk for salmonellosis.

Au-dessus de 60°C le risque de salmonellose est éliminé.

Oberhalb von 60°C beseitigt man jegliches Risiko von Salmonelleninfektion.

Por encima de los 60°C, se elimina cualquier riesgo de salmonelosis.

Composizione

Cod. 5BFB1120

- 1 BACINELLA FORATA
PER PORTA BROCCHE
Perforated tray for jugs
Bac percé pour carafes
Gelochte Krughalterschale

Cuenco perforado para porta-jarras

Cod. 5BP11100

- 1 BACINELLA PC 1/1
PC basin
Bac PC
PC basis
Cubeta PC

Cod. 97200096

- 3 BROCCHE VETRO BUFFET
lt. 1,5
Jug
Carafe
Krüge
Jarra

Cod. 5FP11000

- 1 FALSO FONDO FORATO PC
Perforated PC false bottom
Faux fond percé PC
Gelochter falscher Boden PC
Doble fondo perforado PC

Cod. 97150276

- 4 GEL PACK cm. 20x9,8
Refrigerating brick
Briquette réfrigérante

Kühlakku

Refrigerado

Cod. 9715B751

- 1 BASE BASSA IN MDF
Low base
Base basse
Niedrigen Basis
Base baja





Porta brocche (completo di 3 brocche da 1,5 lt) a doppia parete refrigerato

Cod. 511B1A00

Refrigeret double wall 3 pieces jug holder (including 3 jugs of 1,5 liters each).

Porte-carafes réfrigérant à double paroi (complet de 3 carafes de 1.5 l).

Krughalter (komplett mit 3 Krügen zu 1,5 l), doppelwandig, gekühlt.

Porta-jarras (con 3 jarras de 1,5 l) con pared doble refrigerado.

Diagramma del mantenimento della temperatura

Temperature maintenance diagram - Diagramme de maintien de la température
Diagramm zur Temperaturerhaltung - Diagrama de mantenimiento de la temperatura

Temperatura / Temperature / Température / Temperatur / Temperá (°C)

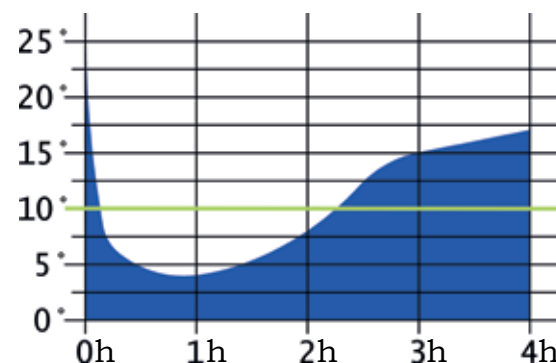

Tempo / Time / Temps / Zeit / Tiempo (h)

Al di sopra dei 60°C si elimina qualsiasi rischio di salmonellosi.

Above 60°C, there is no risk for salmonellosis.

Au-dessus de 60°C le risque de salmonellose est éliminé.

Oberhalb von 60°C beseitigt man jegliches Risiko von Salmonelleninfektion.

Por encima de los 60°C, se elimina cualquier riesgo de salmonelosis.

Composizione

Cod. 30595559

1 VASCA BAGNOMARIA 1/1 h 110

Gastronorm bain marie basin

Bac de bain-marie GN

Wasserbad-Wanne GN

Recipiente baño-maría GN

Cod. 5TFB1140

1 TEGLIA FORATA

PER PORTA BOTTIGLIE

Perforated tray for bottles

Bac percé pour bouteilles

Gelochtes Flaschenhalterblech

Fuente perforada para porta-botellas

Cod. 5FP11000

1 FALSO FONDO FORATO PC

Perforated PC false bottom

Faux fond percé PC

Gelochter falscher Boden PC

Doble fondo perforado PC

Cod. 97150276

4 GEL PACK cm. 20x9,8

Refrigerating brick

Briquette réfrigérante

Kühlakku

Refrigerado

Cod. 9715B751

1 BASE BASSA IN MDF

Low base

Base basse

Niedrigen Basis

Base baja

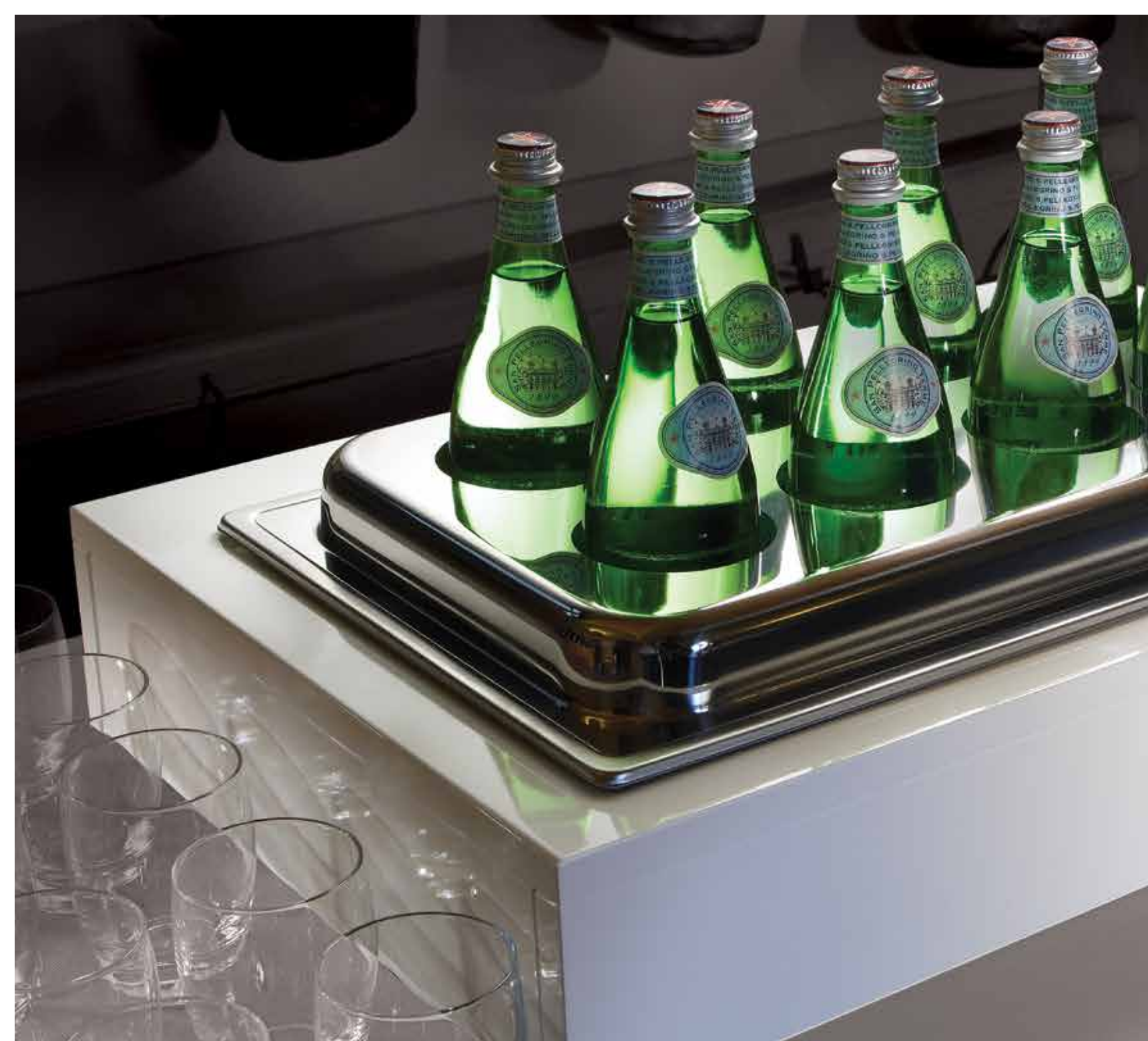

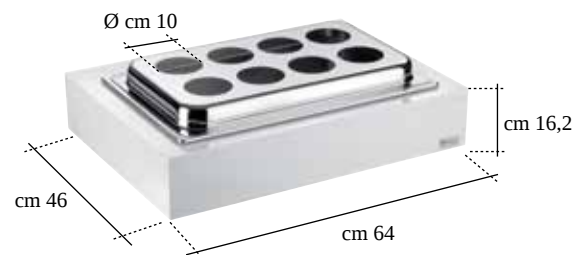

Porta bottiglie a doppia parete refrigerato

Cod. 511B3700

Refrigeret double wall 8 pieces bottles holder.

Porte-bouteilles réfrigérant à double paroi.

Flaschenhalter, doppelwandig, gekühlt.

Porta-botellas con doble pared refrigerado.

Diagramma del mantenimento della temperatura

Temperature maintenance diagram - Diagramme de maintien de la température
Diagramm zur Temperaturerhaltung - Diagrama de mantenimiento de la temperatura

Temperatura / Temperature / Température / Temperatur / Temperá (°C)

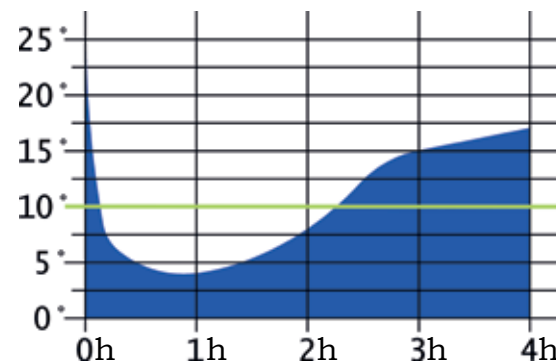

Tempo / Time / Temps / Zeit / Tiempo (h)

— Al di sopra dei 60°C si elimina qualsiasi rischio di salmonellosi.

Above 60°C, there is no risk for salmonellosis.

Au-dessus de 60°C le risque de salmonellose est éliminé.

Oberhalb von 60°C beseitigt man jegliches Risiko von Salmonelleninfektion.

Por encima de los 60°C, se elimina cualquier riesgo de salmonelosis.

Composizione

Cod. D0595561

- 1 VASCA BAGNOMARIA 1/1
h 110 C/VITI

Gastronorm bain marie basin

Bac de bain-marie GN

Wasserbad-Wanne GN

Recipiente baño-maría GN

Cod. 5BP13100

- 3 BACINELLE GN PC 1/3 h 100

PC Gastronorm basin

Bac gastronorm PC

Durchbrochener basis PC

Cubeta gastronómico PC

Cod. 5FF11000

- 1 FALSO FONDO GN 1/1 FORATO

Perforated false bottom

Faux fond percé

Gelochter falscher Boden

Doble fondo perforado

Cod. 97150276

- 4 GEL PACK cm. 20x9,8

Refrigerating brick

Briquette réfrigérante

Kühlakku

Refrigerado

Cod. 97150112

- 1 CUPOLA RETT. APRIBILE PC

Rectangular dome lid

Cloche rectangulaire

Rolltop

Campana rectangular

Cod. 9715B751

- 1 BASE BASSA IN MDF

Low base

Base basse

Niedrigen Basis

Base baja





Porta yogurt e verdure a doppia parete refrigerato

Cod. 511B2840

Double wall refrigeret basin with cover for yoghurt and vegetables.

Plateau réfrigérant double paroi avec cloche pour yaourt et légumes.

Joghurt- und Gemüseschalenhalter, doppelwandig, gekühlt mit Haube.

Porta-yogur y verduras con doble pared refrigerada con campana.

Diagramma del mantenimento della temperatura

Temperature maintenance diagram - Diagramme de maintien de la température
Diagramm zur Temperaturerhaltung - Diagrama de mantenimiento de la temperatura

Temperatura / Temperature / Température / Temperatur / Temperá (°C)

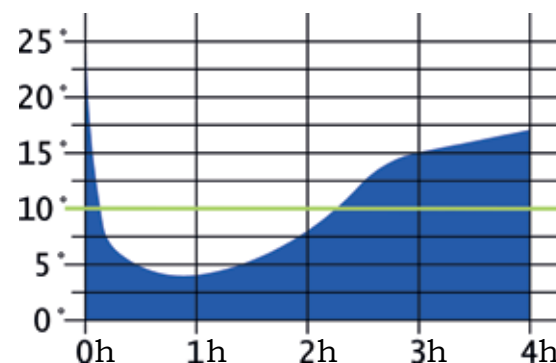

Tempo / Time / Temps / Zeit / Tiempo (h)

— Al di sopra dei 60°C si elimina qualsiasi rischio di salmonellosi.

Above 60°C, there is no risk for salmonellosis.

Au-dessus de 60°C le risque de salmonellose est éliminé.

Oberhalb von 60°C beseitigt man jegliches Risiko von Salmonelleninfektion.

Por encima de los 60°C, se elimina cualquier riesgo de salmonelosis.



Composizione

Cod. 5BP11065

- 1 BACINELLA GN PC 1/1 h 65
Gastronorm basin
Bac gastronorm
Durchbrochener basis
Cubeta gastronorm

Cod. FBAF2840

- 2 BACINELLE GN 2/8 h 40
SOVRAPP. C/FORCELLE
GN stackable basin with hooks
Bac GN superposable avec crochets
Schüssel GN stapelbar mit
Aufnahmegabeln für Haube
Cuenco GN superpuesto con asas

Cod. 5BA28040

- 2 BACINELLE GN 2/8 h 40
Gastronorm basin
Bac gastronorm
Durchbrochener basis
Cubeta gastronorm

Cod. 5FP11000

- 1 FALSO FONDO GN PC 1/1 h 65
FORATO
PC Perforated false bottom
Faux fond percé PC
Gelochter falscher Boden PC
Doble fondo perforado PC

Cod. 97150276

- 4 GEL PACK cm. 20x9,8
Refrigerating brick
Briquette réfrigérante
Kühlakku
Refrigerado

Cod. 97150112

- 1 CUPOLA RETT. APRIBILE PC
Rectangular dome lid
Cloche rectangulaire
Rolltop
Campana rectangular

Cod. 9715B751

- 1 BASE BASSA IN MDF
Low base
Base basse
Niedrigen Basis
Base baja

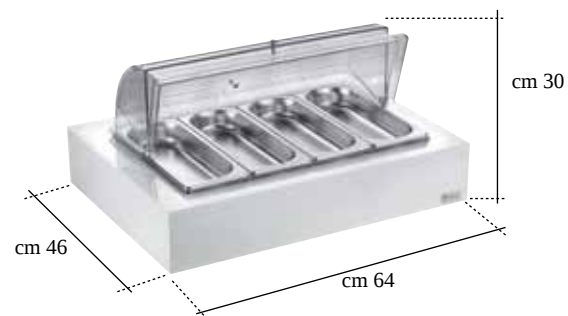

Porta verdure refrigerato

Cod. 511B2820

Refrigerated basin with cover for vegetables.

Plateau légumes réfrigérant avec cloche.

Gemüseschalenhalter, gekühlt mit Haube.

Porta-verduras refrigerado con campana.

Diagramma del mantenimento della temperatura

Temperature maintenance diagram - Diagramme de maintien de la température
Diagramm zur Temperaturerhaltung - Diagrama de mantenimiento de la temperatura

Temperatura / Temperature / Température / Temperatur / Temperá (°C)

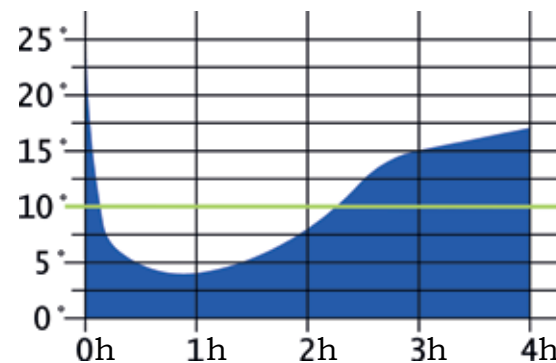

Tempo / Time / Temps / Zeit / Tiempo (h)

— Al di sopra dei 60°C si elimina qualsiasi rischio di salmonellosi.

Above 60°C, there is no risk for salmonellosis.

Au-dessus de 60°C le risque de salmonellose est éliminé.

Oberhalb von 60°C beseitigt man jegliches Risiko von Salmonelleninfektion.

Por encima de los 60°C, se elimina cualquier riesgo de salmonelosis.

Composizione

Cod. 5BP11065

1 BACINELLA GN PC 1/1 h 65

PC Gastronorm basin

Bac gastronorm PC

Durchbrochener basis PC

Cubeta gastronómico PC

Cod. 5BFY1120

1 BACINELLA FORATA

PER PORTA YOGURT

Perforated tray for yoghurt

Plateau percé porte-yaourt

Gelochte Joghurthalterschale

Cuenco perforado para porta-yogur

Cod. 5FP11000

1 FALSO FONDO FORATO PC

Perforated PC false bottom

Faux fond percé PC

Gelochter falscher Boden PC

Doble fondo perforado PC

Cod. 97150276

4 GEL PACK cm. 20x9,8

Refrigerating brick

Briquette réfrigérante

Kühlakku

Refrigerado

Cod. 9715B751

1 BASE BASSA IN MDF

Low base

Base basse

Niedrigen Basis

Base baja



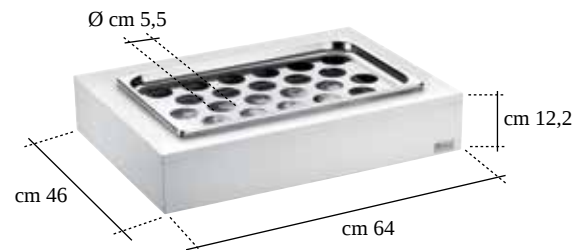

Porta yogurt refrigerato con 22 spazi Cod. 511B2900

Refrigeret tray with 22 holes for yoghurt.

Porte-yaourt réfrigérant à 22 trous.

Joghurthalterschale, gekühlt mit 22 Plätzen.

Porta-yogur refrigerado con 22 compartimentos.

Diagramma del mantenimento della temperatura

Temperature maintenance diagram - Diagramme de maintien de la température
Diagramm zur Temperaturerhaltung - Diagrama de mantenimiento de la temperatura

Temperatura / Temperature / Température / Temperatur / Temperá (°C)

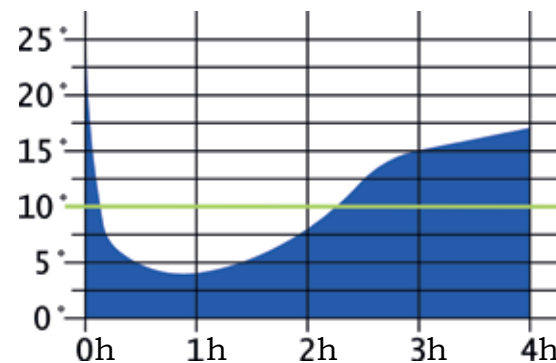

Tempo / Time / Temps / Zeit / Tiempo (h)

— Al di sopra dei 60°C si elimina qualsiasi rischio di salmonellosi.

Above 60°C, there is no risk for salmonellosis.

Au-dessus de 60°C le risque de salmonellose est éliminé.

Oberhalb von 60°C beseitigt man jegliches Risiko von Salmonelleninfektion.

Por encima de los 60°C, se elimina cualquier riesgo de salmonelosis.

Composizione

Cod. FBAF1120

2 BACINELLA GN 1/1 h 20
C/FORCELLE
Basin with hooks
Bac avec crochets

Schüssel mit Aufnahmegabeln für
Haube

Cuenco c/asas

Cod. 5T11040

2 TEGLIA GN 1/1 h 40
Gastronorm basin
Plat gastronorm

Durchbrochener blech

Fuente gastronómica

Cod. 5FP11000

2 FALSO FONDO FORATO PC
Perforated PC false bottom

Faux fond percé PC

Gelochter falscher Boden PC

Doble fondo perforado PC

Cod. 97150276

8 GEL PACK cm. 20x9,8

Refrigerating brick

Briquette réfrigérante

Kühlakku

Refrigerado

Cod. 97150112

2 CUPOLA RETT. APRIBILE PC

Rectangular dome lid

Cloche rectangulaire

Rolltop

Campana rectangular

Cod. 9715B754

1 ALZATA DOPPIA IN MDF

Double deck trays

Plateau double

Doppelte Etagere

De dos pisos





Alzata 2 piani con doppia cupola refrigerata

Cod. 511B1054

Refrigerated double deck rectangular trays with covers.

Plateau à deux étages réfrigérés avec cloche.

2 Etagen-Etagere mit rechteckigen Tablett mit Rolltop, gekühlt.

Presentador de dos pisos refrigerado con doble campana.

Diagramma del mantenimento della temperatura

Temperature maintenance diagram - Diagramme de maintien de la température
Diagramm zur Temperaturerhaltung - Diagrama de mantenimiento de la temperatura

Temperatura / Temperature / Température / Temperatur / Temperá (°C)

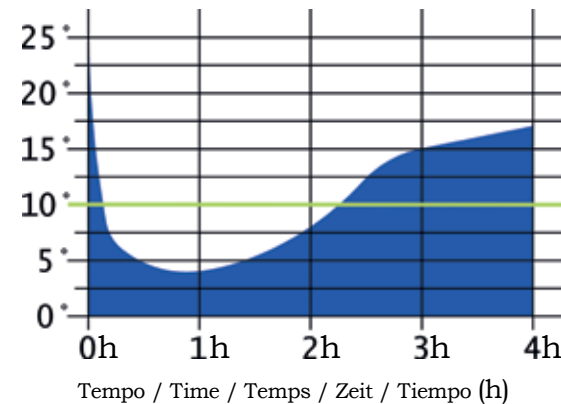

— Al di sopra dei 60°C si elimina qualsiasi rischio di salmonellosi.

Above 60°C, there is no risk for salmonellosis.

Au-dessus de 60°C le risque de salmonellose est éliminé.

Oberhalb von 60°C beseitigt man jegliches Risiko von Salmonelleninfektion.

Por encima de los 60°C, se elimina cualquier riesgo de salmonelosis.

Composizione

Cod. 5BA23020

3 BACINELLE GN 2/3 h 20

Gastronorm basin

Bac gastronorm

Durchbrochener basis

Cubeta gastronómica

Cod. 5BA23040

3 BACINELLE GN 2/3 h 40

Gastronorm basin

Bac gastronorm

Durchbrochener basis

Cubeta gastronómica ico

Cod. 5FF23000

3 FALSO FONDO FORATO PC

Perforated PC false bottom

Faux fond percé PC

Gelochter falscher Boden PC

Doble fondo perforado PC

Cod. 97150276

6 GEL PACK cm. 20x9,8

Refrigerating brick

Briquette réfrigérante

Kühlakku

Refrigerado

Cod. 9715B775

1 ALZATA 3 PIANI IN MDF

3 levels fixed stand

Etagère fixe 3 niveaux

3-Etagen-Etagere

Presentador de 3 pisos

Optional

Cod. 97150782

CUPOLA PC PER BACINELLA

GN 2/3

cm 36x40x15

PC GN 2/3 basin cover lid.





Alzata 3 piani con vassoi quadrati GN 2/3 refrigerata

Cod. 511B1058

3 levels fixed cooled stand with GN 2/3 squared tray.

Etagère fixe 3 niveaux avec plateaux carrés GN 2/3 (congelée).

3-Etagen-Etagere mit rechteckigen Tablettis GN 2/3 gekühlt.

Presentador de 3 pisos con bandejas cuadradas GN 2/3 refrigerado.

Diagramma del mantenimento della temperatura

Temperature maintenance diagram - Diagramme de maintien de la température
Diagramm zur Temperaturerhaltung - Diagrama de mantenimiento de la temperatura

Temperatura / Temperature / Température / Temperatur / Temperá (°C)

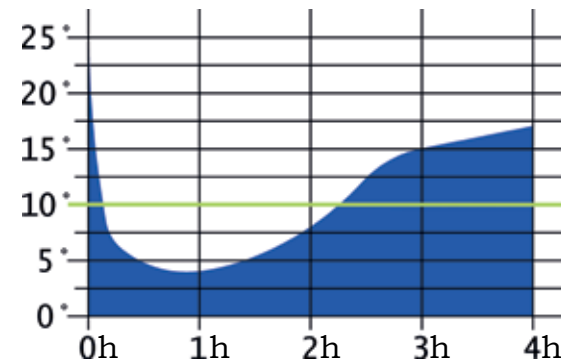

Tempo / Time / Temps / Zeit / Tiempo (h)

— Al di sopra dei 60°C si elimina qualsiasi rischio di salmonellosi.

Above 60°C, there is no risk for salmonellosis.

Au-dessus de 60°C le risque de salmonellose est éliminé.

Oberhalb von 60°C beseitigt man jegliches Risiko von Salmonelleninfektion.

Por encima de los 60°C, se elimina cualquier riesgo de salmonelosis.

Componentistica: vedi pag. / Technical card: see page / Fiches techniques: voir page / Technische karten: Siehe Seite / Tarjetas técnicas: ver pagina 166

Note Informativa: vedi pag. / Technical information: see page / Notes d'information: voir page / Hinweise teile: Siehe Seite / Notas informativas: ver pagina 180

Acciaio Inossidabile 18/10 & MDF / Stainless steel 18/10 & MDF / Acier 18/10 & MDF / Edelstahl 18/10 & MDF / Acero 18/10 & MDF



Neutri

I Neutri Buffet 5 stelle fanno parte di un elegante coordinato di oggetti per le nuove tendenze di presentazione e servizio della ristorazione.

The Neutral Buffet line elegantly coordinates the objects for the new presentation trend of catering and service.

Esaltano una perfetta esposizione degli alimenti: cupola e coperchi proteggono gli i cibi da agenti esterni secondo le normative igieniche europee.

The Neutral Buffet line magnifies foodstuff presentation: the lids and covers preserves it from outside contamination according to the European hygienic norms.



Composizione

Cod. FBAF1120

1 BACINELLA GN 1/1 h 20
C/FORCELLA

Gastronorm basin with hooks
Bac gastronorm avec crochets
Durchbrochener basis mit
Aufnahmegabeln für Haube
Cubeta gastronómica con asas

Cod. 97150112

1 CUPOLA RETT. APRIBILE PC

Rectangular dome lid
Cloche rectangulaire
Rolltop

Campana rectangular

Cod. 9715B751

1 BASE BASSA IN MDF

Low base

Base basse

Niedrigen Basis

Base baja





Vassoio rettangolare pasticceria con cupola

Cod. 511B0920

Rectangular tray with cover for pastries.

Plateau rectangulaire à pâtisserie.

Rechteckiges tablett 1/1 mit rolltop.

Bandeja rectangular para pastelería.

Componentistica: vedi pag. / Technical card: see page / Fiches techniques: voir page / Technische karten: Siehe Seite / Tarjetas técnicas: ver pagina 166

Note Informativa: vedi pag. / Technical information: see page / Notes d'information: voir page / Hinweise teile: Siehe Seite / Notas informativas: ver pagina 180

Acciaio Inossidabile 18/10 & MDF / Stainless steel 18/10 & MDF / Acier 18/10 & MDF / Edelstahl 18/10 & MDF / Acero 18/10 & MDF

Composizione

Cod. FBAF1120

1 BACINELLA GN 1/1 h 20
C/FORCELLA

Gastronorm basin with hooks

Bac gastronorm avec crochets

Durchbrochener basis mit

Aufnahmegabeln für Haube

Cubeta gastronómica con asas

Cod. 97150174

1 TAGLIERE IN POLIPROPILENE

NERO cm 50x30x2,3

Polypropilene board

Hachoir en polypropylène

Küchenbrett aus polypropylen

Tabla en polipropileno

Cod. 97150112

1 CUPOLA RETT. APRIBILE PC

Rectangular dome lid

Cloche rectangulaire

Rolltop

Campana rectangular

Cod. 9715B751

1 BASE BASSA IN MDF

Low base

Base basse

Niedrigen Basis

Base baja





Vassoio per formaggi con tagliere in polietilene ad alta resistenza

Cod. 511B0940

Rectangular cheese tray with non-deformable polyethylene board.

Plateau à fromages avec planche à découper en polyéthylène.

Rechteckiges Käsetablett 1/1 aus Polyethylen mit Rolltop , hoher Widerstand.

Bandeja rectangular para queso con tabla de polietileno.

Componentistica: vedi pag. / Technical card: see page / Fiches techniques: voir page / Technische karten: Siehe Seite / Tarjetas técnicas: ver pagina 166

Note Informativa: vedi pag. / Technical information: see page / Notes d'information: voir page / Hinweise teile: Siehe Seite / Notas informativas: ver pagina 180

Acciaio Inossidabile 18/10 & MDF / Stainless steel 18/10 & MDF / Acier 18/10 & MDF / Edelstahl 18/10 & MDF / Acero 18/10 & MDF

Composizione

Cod. 5TI11040

1 TEGLIA 1/1 h 40

Gastronorm basin

Plat gastronorm

Durchbrochener blech

Fuente gastronomic

Cod. L7150760

1 CESTA PANE PAGLIA

C/FORCELLE

Paill bread basket with hooks

Corbeille a pain avec crochets

Brotkorb mit Aufnahmegabeln für Haub

Cesto para el pan con asas

Cod. 97150112

1 CUPOLA RETT. APRIBILE PC

Rectangular dome lid

Cloche rectangulaire

Rolltop

Campana rectangular

Cod. 9715B751

1 BASE BASSA IN MDF

Low base

Base basse

Niedrigen Basis

Base baja

Cod. L7150759

1 CESTA PANE WENGE

C/FORCELLE

Wenge bread basket with hooks

Corbeille a pain avec crochets

Brotkorb mit Aufnahmegabeln für Haub

Cesto para el pan con asas





Cesta pane color paglia con cupola

Cod. 511B6700

Paill bread basket with cover.

Corbeille à pain avec cloche.

Brotkorb mit Haube.

Cesto para el pan con campana.

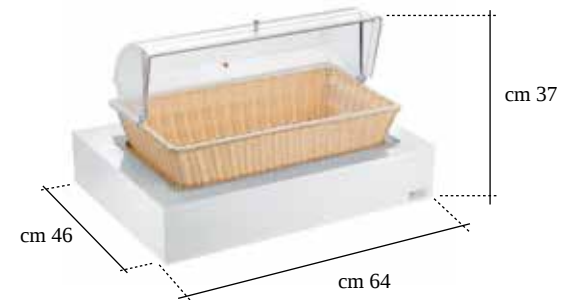

Cesta pane color wenge con cupola

Cod. 511B6900

Wenge bread basket with cover.

Corbeille à pain avec cloche.

Brotkorb mit Haube.

Cesto para el pan con campana.

Composizione

Cod. 5TI11020

1 TEGLIA GN 1/1 h 20

Gastronorm basin

Plat gastronorm

Durchbrochener blech

Fuente gastronormic

Cod. 97150164

1 TAGLIERE PANE

IN LEGNO NATURALE

Wood bread board

Planche en hêtre a couper le pain

Schneidbrett aus Buche

Tabla de haya de cortar pan

Cod. 9715B751

1 BASE BASSA IN MDF

Low base

Base basse

Niedrigen Basis

Base baja

Optional

Cod. 741000EM

COLTELLO PANE PROFESSIONAL

cm. 20

Professional bread knife.

Cod. 741000E5

COLTELLO PANE PROFESSIONAL

cm. 28

Professional bread knife.





Tagliere pane in legno naturale

Cod. 511B6800

Bread board.

Planche à couper le pain.

Scneidbrett.

Tabla de cortar pan.



Composizione

Cod. 30595559

1 VASCA CHAFING DISH 1/1 h 110

Chafing dish basin

Bac de chauffe-plats

Chafing Dish basis

Recipiente calentaplatos

Cod. 5TFC1140

1 TEGLIA FORATA

PER PORTA CHAMPAGNE

Perforated tray for champagne

Plateau rectangulaire pour champagne

Gelochtes Blech für Champagner-Kübel

Fuente perforada para porta-champagne

Cod. F1132600

2 PENTOLE PORTA

CHAMPAGNE lt. 7

Champagne pot

Bain-marie gastronom Marmite pour

champagne

Champagner-Kübel

Cubo porta-champagne

Cod. 9715B751

1 BASE BASSA IN MDF

Low base

Base basse

Niedrigen Basis

Base baja



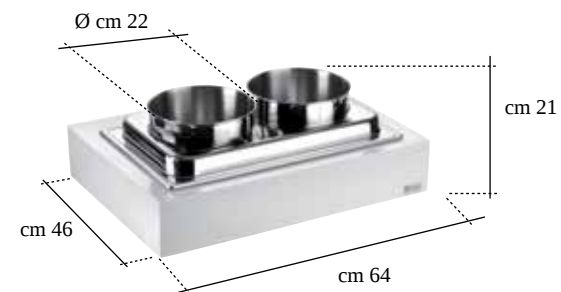

Porta champagne / Doppia punch bowl

7,0 lt

Cod. 511B2600

Champagne holder - Double punch bowl.

Plateau pour champagne - Double punch bowl.

Champagner-Kübel – Doppeltes Punch Bowl.

Porta-champagne - Doble punch bowl.

Componentistica: vedi pag. / Technical card: see page / Fiches techniques: voir page / Technische karten: Siehe Seite / Tarjetas técnicas: ver pagina 166

Note Informativa: vedi pag. / Technical information: see page / Notes d'information: voir page / Hinweise teile: Siehe Seite / Notas informativas: ver pagina 180

Acciaio Inossidabile 18/10 & MDF / Stainless steel 18/10 & MDF / Acier 18/10 & MDF / Edelstahl 18/10 & MDF / Acero 18/10 & MDF

Composizione

[Cod. 30595559](#)

1 VASCA BAGNOMARIA
PER CHAFING DISH 1/1 h 110

Gastronorm bain marie basin

Bac de bain-marie GN

Wasserbad-Wanne GN

Recipiente baño-maría GN

[Cod. FBAF2865](#)

2 BACINELLE GN 2/8 h 65
C/FORCELLA

Gastronorm basin with hooks

Bac gastronorm avec crochets

Durchbrochener basis mit

Aufnahmegabeln für Haub

Cubeta gastronormic con asas

[Cod. 5BA28065](#)

2 BACINELLE GN 2/8 h 65

Gastronorm basin

Bac gastronorm

Durchbrochener basis

Cubeta gastronormic

[Cod. 97150112](#)

1 CUPOLA RETT. APRIBILE PC

Rectangular dome lid

Cloche rectangulaire

Rolltop

Campana rectangular

[Cod. 9715B751](#)

1 BASE BASSA IN MDF

Low base

Base basse

Niedrigen Basis

Base baja





Vassoio porta posate

Cod. 511B3900

Cutlery containers.

Plateau double en bois.

Besteckschalen-Aufnahmetablett.

Bandeja porta-cubiertos.

Composizione

Cod. 97200099

24 CIOTOLE IN VETRO

Ø cm. 12

Glass bowls

Bols en verre

Glasschuessel

Cuencos en vidrio

Cod. 9715B798

1 BASE PER PORTACIOTOLE 24 PZ

Glassholder

Base pour porte-bols

Tablett für Glasschuessel

Base por pota-cuencos

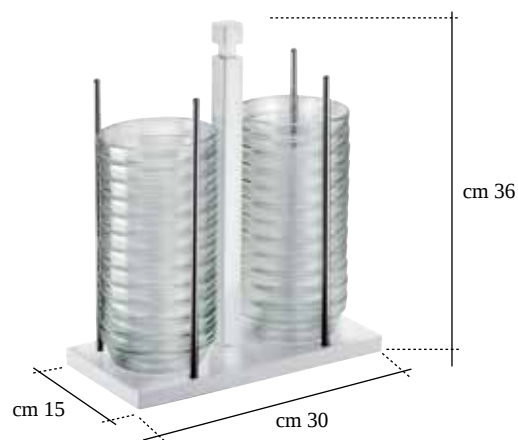

Portaciotole 24 pz. ciotola in vetro Ø cm 12 Cod. 511B3424

Chinaware (glass) holder.

Porte-bols en verre.

Schuesselset 24 tlg.

Porta-cuencos en vidrio.

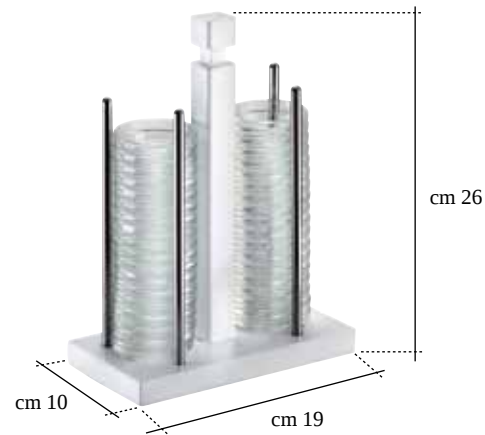

Portaciotole
36 pz.
ciotola in vetro Ø cm 6
Cod. 511B3436

Chinaware (glass) holder.

Porte-bols en verre.

Schuesselset 36 tlg.

Porta-cuencos en vidrio.

Composizione

Cod. 9720098

36 CIOTOLE IN VETRO

Ø cm. 6

Glass bowls

Bols en verre

Glasschuessel

Cuencos en vidrio

Cod. 9715B799

1 BASE PER PORTACIOTOLE 36 PZ

Glassholder

Base pour porte-bols

Tablett für Glasschuessel

Base por pota-cuencos

PINTEI buffet
made in
Italy
★★★★★

Neutri Neutral

55

Composizione

Cod. FBAF1120

2 BACINELLE GN 1/1 h 20

C/FORCELLA

Gastronorm bain marie with hooks

Bain-marie gastronorm avec crochets

Bain marie gastronorm mit

Aufnahmegabeln für Haub

Baño maria gastronómico con asas

Cod. 97150112

2 CUPOLE RETT. APRIBILE PC

Rectangular dome lid

Cloche rectangulaire

Rolltop

Campana rectangular

Cod. 9715B754

1 ALZATA DOPPIA IN MDF

Double deck trays

Plateau double

Doppelte Etagere

De dos pisos





Alzata 2 piani con doppia cupola con vassoi per pasticceria

Cod. 511B1055

Double deck rectangular trays with covers for pastries.

Plateau à 2 étages avec plateaux rectangulaires pour pâtisserie et double cloche.

2 Etagen-Etagere mit rechteckigen Tablett für Backwaren mit doppelter Haube.

De 2 pisos con bandejas rectangulares para pasteles con doble campana.

Componentistica: vedi pag. / Technical card: see page / Fiches techniques: voir page / Technische karten: Siehe Seite / Tarjetas técnicas: ver pagina 166

Note Informativa: vedi pag. / Technical information: see page / Notes d'information: voir page / Hinweise teile: Siehe Seite / Notas informativas: ver pagina 180

Acciaio Inossidabile 18/10 & MDF / Stainless steel 18/10 & MDF / Acier 18/10 & MDF / Edelstahl 18/10 & MDF / Acero 18/10 & MDF



Composizione

Cod. 5TIR1120

1 TEGLIA GN 1/1 h 20

C/RINGHIERE

GN tray with edges

Plat GN avec bords

Blech GN mit Seitenbügel

Fuente GN con bordes

Cod. 5TIR1140

1 TEGLIA GN 1/1 h 40

C/RINGHIERE

GN tray with edges

Plat GN avec bords

Bain-marie deckel mit schlitz

Baño maria gastronomico

Cod. 9715B754

1 ALZATA DOPPIA IN MDF

Double deck trays

Plateau double

Doppelte Etagere

De dos pisos



Porta frutta a 2 piani Cod. 511B1056

Double deck trays for fruit.

Fruitier à 2 étages avec base en Mdf.

2 Etagen-Obstschale mit Mdf basis.

Frutero de 2 pisos con base de Mdf.

Composizione

Cod. 5BA23020

3 BACINELLE GN 2/3 h 20

Gastronorm basin

Bac gastronorm

Durchbrochener basis

Cubeta gastronómica

Cod. 9715B775

1 ALZATA 3 PIANI IN MDF

3 levels fixed stand

Etagère fixe 3 niveaux

3-Etagen-Etagere

Presentador de 3 pisos

Optional

Cod. 97150782

CUPOLA PC PER BACINELLA

GN 2/3

cm 36x40x15

PC GN 2/3 basin cover lid.



Alzata 3 piani con vassoi quadrati GN 2/3

Cod. 511B1057

3 levels fixed stand with GN 2/3 squared tray.

Etagère fixe 3 niveaux avec plateaux carrés GN 2/3.

3-Etagen-Etagere mit rechteckigen Tablett GN 2/3.

Presentador de 3 pisos con bandejas cuadradas GN 2/3.





Distributori

I Distributori Buffet montano rubinetti Tomlinson di elevata qualità riconosciuta a livello internazionale, sono facilmente rintracciabili e sostituibili in tutti i paesi.

Buffet Dispensers are provided with premium quality Tomlinson taps, internationally recognized. Taps are easily available in each country.

DISTRIBUTORE BEVANDE CALDE:

è studiato per mantenere la temperatura costante di latte, caffè, acqua, the, ecc.

Avvertenza: i liquidi devono essere immessi nel distributore già alla temperatura desiderata.

HOT DRINK DISPENSER:

had been designed to maintain the temperature of the content.

Attention : liquids shall be put into the container at the wanted temperature.

DISTRIBUTORE SUCCHI E BEVANDE:

è caratterizzato da un contenitore in polycarbonato dotato di colonna refrigerante.

JUICE AND DRINK DISPENSER:

it has a polycarbonate dispenser with refrigerating pipe for ice cubes.

DISTRIBUTORE CEREALI E MUESLI

dotato di mulino porzionatore.

CEREAL DISPENSER:

with mill scoop.





Composizione

Cod. F0959524

1 DISTRIB. BEVANDE CALDE
C/MANIGLIA cm. 24 lt. 8

Hot drink dispenser

Distributeur de boissons chaudes

Spender für warme Getränke

Rejilla para dispensador

Cod. 5BA16020

1 BACINELLA GN 1/6 h 20

Gastronorm basin

Bac gastronorm

Durchbrochener basis

Cubeta gastronómica

Cod. 50902613

1 GRIGLIA 1/6 PER DISTRIBUTORE

Grill for dispenser.

Grille pour distributeur

Rost für Getränkedispenser

Baño maria gastronómico

Cod. 50959522

1 COPERCHIO PER

DISTRIBUTORE LATTE SAMOVAR

Lid for Samovar milk dispenser

Couvercle pour distributeur à lait

Samovar

Deckel für Milchdispenser Samovar

Tapa para dispensador de leche Samovar

Cod. 97150221

1 RUBINETTO SMONTABILE

IN PPL TOMLINSON

Tomlinson PPL faucet

Robinet démontable en PPL Tomlinson

Abnehmbarer hahn aus PPL Tomlinson

Grifo desmontable de PPL Tomlinson

Cod. 97150119*

1 RESISTENZA ELETTRICA

C/REGOLATORE

230V 240 W

Electric resistance

Résistance électrique

Elektrischer Widerstand

Resistencia eléctrica

Cod. H2959523

1 PORTA RESISTENZA

Stand for electric resistance

Porte- résistance électrique chauffante

Halter fuer elektrischen Widerstand

Porta- resistencia eléctrica

Cod. 9715B758

1 STRUTT. IN MDF PER DISTRIB.

BEVANDE CALDE

Structure for hot drink dispenser

Struct. pour distrib. à boissons chaudes

Struktur für warme Getränke Dispenser

Estructura para disp. de bebidas calientes



Distributore bevande calde corredato di resistenza elettrica con selettore

230 Volt 240 Watt

Ø cm. 24 lt. 8

Cod. 511B9527

Hot drinks dispenser provided with electric resistance.

Distributeurs de boissons chaudes avec résistance électrique.

Spender für warme Getränke ausgestattet mit elektrischer Heizung.

Distribuidores de bebidas calientes con resistencia eléctrica.

Diagramma del mantenimento della temperatura

Temperature maintenance diagram - Diagramme de maintien de la température
Diagramm zur Temperaturerhaltung - Diagrama de mantenimiento de la temperatura

Temperatura / Temperature / Température / Temperatur / Temperatura (°C)

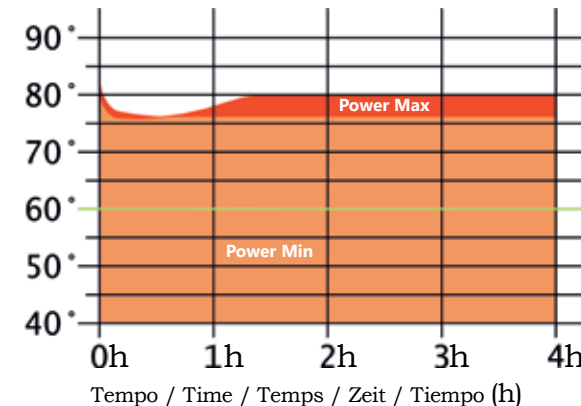

— Al di sopra dei 60°C si elimina qualsiasi rischio di salmonellosi.

Above 60°C, there is no risk for salmonellosis.

Au-dessus de 60°C le risque de salmonellose est éliminé.

Oberhalb von 60°C beseitigt man jegliches Risiko von Salmonelleninfektion.

Por encima de los 60°C, se elimina cualquier riesgo de salmonelosis.



Composizione

Cod. 97150039

1 CONTENITORE BEVANDE
COMPLETO DI RUBINETTO
TOMLINSON
cm. 20 lt. 9,5

Juice dispenser with Tomlinson tap
Fontaine à jus de fruits avec robinet
Tomlinson

Saftspender mit Tomlinsonshahn
Surtidor de zumos con grifo Tomlinson
Cod. 50955421

1 COPERCHIO C/POMOLO
cm. 20

Lid with knob
Couvercle avec pommeau
Deckel mit Griff
Tapa con agarradera
Cod. 93191076

1 PERNO DI BLOCCAGGIO
Lockpin

Pivot de blocage du distributeur
Stecknadel
Pin de cierre

Cod. 5BA16020

1 BACINELLA GN 1/6 h 20

Gastronorm basin
Bac gastronorm
Durchbrochener basis
Cubeta gastronormica

Cod. 50902613

1 GRIGLIA 1/6 PER DISTRIBUTORE

Grill for dispenser.
Grille pour distributeur
Rost für Getränkedispenser
Baño maria gastronómico

Cod. 9715B757

1 STRUTTURA IN MDF PER
DISTRIBUTORE SUCCHI

Structure for juice dispenser.
Structure pour distributeur à jus
Struktur für Saftdispenser
Estructura para dispensador de zumos

Novità

Cod. L7150248 Ø cm 5 lungh cm 35
TUBO REFRIGERANTE

Refrigerant tube.

Cod. 97150248

ANELLO PER TUBO REFRIGERANTE

Ring for refrigerant tube.



Grafico temperatura distributore succhi

Ø cm. 16 - 4,5 lt. / Ø cm. 20 - 9,5 lt.

Temperature diagram juice dispenser - Diagramme de la température Fontaine à jus de fruits

Diagramm zur Temperaturer saftspender - Diagrama de la temperatura surtidor de zumos

Temperatura / Temperature / Température / Temperatur / Temperá (°C)

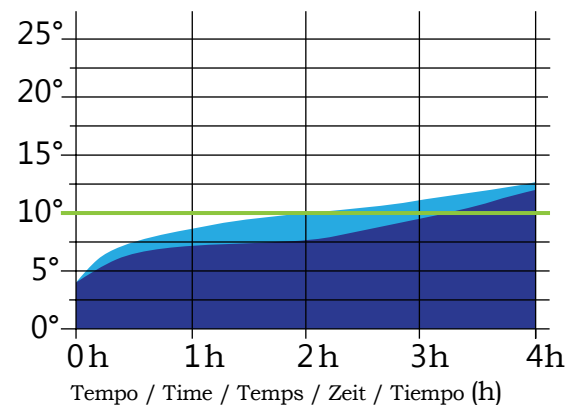

- Senza colonna refrigerante
Without refrigerating pipe for ice cubes - Sans colonne porte-glaçons
Ohne doppelwandige säule - Sin tubo para hielo
- Con colonna refrigerante
With refrigerating pipe for ice cubes - Avec colonne porte-glaçons
Mit doppelwandiger säule - Con tubo para hielo

— Al di sotto dei 10°C si elimina qualsiasi rischio di salmonellosi.
Below 10°C, there is no risk for salmonellosis.
Au-dessous de 10°C le risque de salmonellose est éliminé.
Unterhalb von 10°C beseitigt man jegliches Risiko von Salmonelleninfektion.
Por debajo de los 10°C, se elimina cualquier riesgo de salmonelosis.

Distributore succhi e bevande con colonna refrigerante e rubinetto Tomlinson

Ø cm. 20 lt. 9,5

Cod. 511B5420

Juice and cold drink dispenser with refrigerating pipe for ice cubes.

Fontaine à jus de fruits simple paroi et colonne porte-glaçons.

Spender für Saft und kalte Getränke.

Surtidor de zumos y bebidas con tubo para hielo y grifo Tomlinson.

Componentistica: vedi pag. / Technical card: see page / Fiches techniques: voir page / Technische karten: Siehe Seite / Tarjetas técnicas: ver pagina 166

Note Informativa: vedi pag. / Technical information: see page / Notes d'information: voir page / Hinweise teile: Siehe Seite / Notas informativas: ver pagina 180

Acciaio Inossidabile 18/10 & MDF / Stainless steel 18/10 & MDF / Acier 18/10 & MDF / Edelstahl 18/10 & MDF / Acero 18/10 & MDF

Composizione

Cod. 97150038

1 CONTENITORE BEVANDE
COMPLETO DI RUBINETTO
TOMLINSON
cm. 16 lt. 4,5

Juice dispenser with Tomlison tap
Fontaine à jus de fruits avec robinet
Tomlinson

Saftspender mit Tomlinsonshahn
Surtidor de zumos con grifo Tomlinson
Cod. 50955417

1 COPERCHIO C/POMOLO
cm. 16

Lid with knob
Deckel mit Griff
Bain-marie deckel mit schlitze
Tapa con agarradera
Cod. 93191076

1 PERNO DI BLOCCAGGIO
Lockpin

Pivot de blocage du distributeur
Stecknadel
Pin de cierre
Cod. 5BA16020

1 BACINELLA GN 1/6 h 20
Gastronorm basin
Bac gastronorm
Durchbrochener basis
Cubeta gastronómica
Cod. 50902613

1 GRIGLIA 1/6 PER DISTRIBUTORE
Grill for dispenser.
Grille pour distributeur
Rost für Getränkedispenser
Baño maria gastronómico
Cod. 9715B767

1 STRUTTURA IN MDF PER
DISTRIBUTORE SUCCHI
Structure for juice dispenser.
Structure pour distributeur à jus
Struktur für Saftdispenser

Estructura para dispensador de zumos

Novità

Cod. L7150247 Ø cm 5 lunghezza cm 27,5
TUBO REFRIGERANTE
Refrigerant tube.

Cod. 97150247

ANELLO PER TUBO REFRIGERANTE
Ring for refrigerant tube.



Distributore succhi e bevande con colonna refrigerante e rubinetto Tomlinson

Ø cm. 16 lt. 4,5

Cod. 511B5413

Juice and cold drink dispenser with refrigerating pipe for ice cubes.

Fontaine à jus de fruits simple paroi et colonne porte-glaçons.

Spender für Saft und kalte Getränke.

Surtidor de zumos y bebidas con tubo para hielo y grifo Tomlinson.



Distributore doppio succhi e bevande con colonna refrigerante e rubinetto Tomlinson

Ø cm. 16 lt. 4,5x2

Cod. 511B5416

Double juice and cold drink dispenser with refrigerating pipe for ice cubes.

Fontaine à jus de fruits simple paroi et colonne porte-glaçons, double.

Doppelter Spender für Saft und kalte Getränke

Surtidor de zumos y bebidas doble con tubo para hielo y grifo Tomlinson.

Composizione

Cod. 97150038
2 CONTENITORE BEVANDE
COMPLETO DI RUBINETTO
TOMLINSON
cm. 16 lt. 4,5X2
Juice dispenser with Tomlinson tap
Fontaine à jus de fruits avec robinet
Tomlinson
Saftspender mit Tomlinsonshahn
Surtidor de zumos con grifo Tomlinson

Cod. 50955417

2 COPERCHI C/POMOLO
cm. 16

Lid with knob
Deckel mit Griff

Bain-marie deckel mit schlitze
Tapa con agarradera

Cod. 93191076

2 PERNO DI BLOCCAGGIO
Lockpins

Pivot de blocage du distributeur
Stecknadel

Pin de cierre

Cod. 5BA16020

2 BACINELLE GN 1/6 h 20

Gastronorm basin

Bac gastronorm

Durchbrochener basis

Cubeta gastronorm

Cod. 50902613

2 GRIGLIE 1/6 PER DISTRIBUTORE

Grill for dispenser.

Grille pour distributeur

Rost für Getränkedispenser

Baño maria gastronorm

Cod. 9715B768

1 STRUTTURA IN MDF DOPPIA PER
DISTRIBUTORE SUCCHI

Double structure for juice dispenser.

Structure double pour distributeur à jus

Doppelte struktur für Saftdispenser

Estructura doble para dispensador de zumos

Novità

Cod. L7150247 Ø cm 5 lungh cm 27,5

TUBO REFRIGERANTE

Refrigerant tube.

Cod. 97150247

ANELLO PER TUBO REFRIGERANTE

Ring for refrigerant tube.

Composizione

DISTRIBUTORE
Ø cm. 18

Cod. 97150052

1 DISTRIBUTORE CEREALI
C/COPERCHIO cm.18 lt. 8

Cereal dispenser with lid
Distributeur à céréales avec couvercle
Cerealien-Spender mit Deckel
Dispensador de cereales con tapa

Cod. 5BA28020

1 BACINELLA 2/8 h 20

Gastronorm basin
Bac gastronorm
Durchbrochener basis
Cubeta gastronómica

Cod. 9715B756

1 STRUTTURA IN MDF PER
DISTRIBUTORE CEREALI
Structure for cereal dispenser
Structure pour distributeur à céréales
Struktur für Cerealien-Spender
Estructura para dispensador de cereales

DISTRIBUTORE DOPPIO
Ø cm. 18

Cod. 97150052

2 DISTRIBUTORI CEREALI
C/COPERCHI cm.18 lt. 8x2

Cereal dispenser with lid
Distributeur à céréales avec couvercle
Cerealien-Spender mit Deckel
Dispensador de cereales con tapa

Cod. 5BA28020

2 BACINELLA 2/8 h 20

Gastronorm basin
Bac gastronorm
Durchbrochener basis
Cubeta gastronómica

Cod. 9715B769

1 STRUTTURA IN MDF DOPPIA PER
DISTRIBUTORE CEREALI
Double structure for cereal dispenser
Structure double pour distributeur à
céréales
Doppelte Struktur für Cerealien-Spender
Estructura doble para dispensador de
cereales



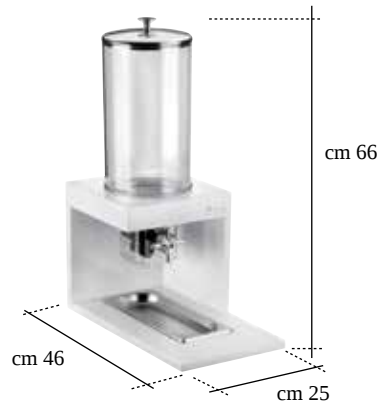

Distributore cereali

Ø cm. 18 lt. 8

Cod. 511B9818

Cereal dispenser.

Distributeur à céréales.

Cerealien-Spender.

Dispensador de cereales.

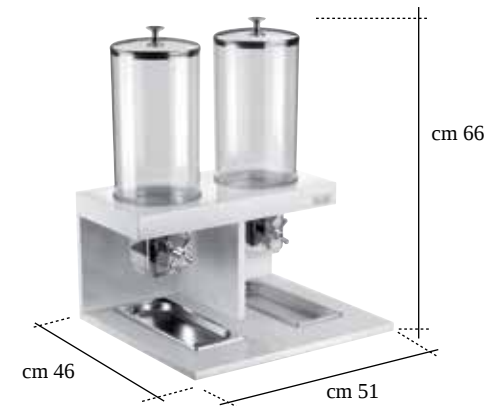

Distributore doppio cereali

Ø cm. 18 lt. 8x2

Cod. 511B9819

Double cereal dispenser.

Distributeur double à céréales.

Doppelter Cerealien-Spender.

Dispensador doble de cereales.

made in
Italy

PINTE *buffet* CLASSIC





Chafing dish rettangolare GN 1/1 con piano in acciaio con chiusura a frizione

Cod. 5113F555

Rectangular chafing dish 1/1 stainless steel border, friction closing.

Chafing dish rect. GN 1/1 avec protection en acier de la base et fermeture à friction.

Chafing Dish mit Edelstahlrand, rechteckig GN 1/1 mit Kupplungsschliessung.

Cubeta GN 1/1 con plancha superior en hacero con cierre con fricción.

Composizione

Cod. D05B5559

1 VASCA BAGNOMARIA
1/1 h110

GN bain marie basin

Cod. D05B5558

1 COPER. RETT. GN
C/POMOLO
GN lid with knob

Cod. 5BA11065

1 BACINELLA GN 1/1 h 65
Gastronorm basin

Cod. 97200078

2 FORNELLETTI INOX
Stainless steel burner holder

Cod. 97200089

2 SUPPORTI PER
FORNELLETTI INOX
Holder for stainless steel burner

Cod. 97150752

1 BASE ALTA IN MDF
C/PIANO IN ACCIAIO

High stand in mdf with steel border

Optional

IL CHAFING DISH È PREDISPOSTO
PER LA RESISTENZA ELETTRICA
CON REGOLATORE

Cod. 97150118 230 Volt 700 Watt

The chafing dish can use a heater.

Porta verdure 4 scomparti riscaldato con piano in acciaio con chiusura a frizione

Cod. 5113F810

Vegetables heating basin, 4 sectors with stainless steel border friction closing.

Porte-aliments pour légumes, 4 compart. complet réchauffé et protect. en acier de la base et fermeture à friction.

Halter für Gemüseschalen mit Edelstahlrand, 4-fach, komplett, beheizt mit Kupplungsschliessung.

Porta-verduras con 4 compart. completo calentado con plancha super en acero con cierre con fricción.

Composizione

Cod. D05B5559

1 VASCA BAGNOMARIA
1/1 h110

GN bain marie basin

Cod. D05B5558

1 COPER. RETT. GN
C/POMOLO
GN lid with knob

Cod. 5BA28065

4 BACINELLE GN 2/8 h 65
Gastronorm basin

Cod. 97200078

2 FORNELLETTI INOX
Stainless steel burner holder

Cod. 97200089

2 SUPPORTI PER
FORNELLETTI INOX
Holder for stainless steel burner

Cod. 97150752

BASE ALTA IN MDF
C/PIANO IN ACCIAIO
High stand in mdf with steel border

Optional

IL PORTAVERDURE È
PREDISPOSTO PER LA RESISTENZA
ELETTRICA CON REGOLATORE

Cod. 97150118 230 Volt 700 Watt

The basin for vegetables can use a heater.



Zuppiera 2 stazioni riscaldata con piano in acciaio 5 lt

Cod. 51135556

Double stainless steel soup bowl, heated.

Soupière à deux stations réchauffés avec protection en acier de la base.

Suppenstation mit Edelstahlrand 2 tlg, beheizt.

Sopera 2 staciones calentada con plancha superior en acero.

Composizione

Cod. D0595559

1 VASCA BAGNOMARIA
1/1 h110 C/GANCI
Gastronorm bain marie basin

Cod. 30595557

1 COPER. PORTA ZUPP. GN
GN lid for soup bowl

Cod. 30597222

2 ZUPPIERE SFERICHE lt. 5
Spherical soup bowl

Cod. 30877522

2 COPER. ZUPPIERA cm. 22
Lid

Cod. 97200078

2 FORELLETTI INOX
Stainless steel burner holder

Cod. 97200089

2 SUPPORTI FORNELLETTI INOX
Holder for stainless steel burner

Cod. 97150752

1 BASE ALTA IN MDF
C/PIANO IN ACCIAIO
High stand in mdf with steel border

Optional

LA ZUPPIERA È PREDISPOSTA PER
LA RESISTENZA ELETTRICA CON
REGOLATORE

Cod. 97150118 230 Volt 700 Watt
The soup bowl can use a heater.



Vassoio per brioches riscaldato con resistenza elettrica 230 Volt 40 Watt

Cod. 51130930

Heating perforated tray with cover for brioche provided with electrical resistance.

Plateau rectangulaire chauffant pour viennoiseries avec résistancé électrique.

Rechteckiges warmhalte-tablett für brioches ausgestattet.

Bandeja rectangular de calentamiento para bollería con resistencia elètrica.

Composizione

Cod. FBAG1120

1 BACINELLA 1/1 h 20
C/FORCELLE E GANCI
Basin with hooks

Cod. H095B953

1 TEGLIA GN 1/1 h40
C/SPACCO
GN basin with slot

Cod. 5FF11000

1 FALSO FONDO
FORATO GN 1/1
Perforated GN False bottom

Cod. 97150770

1 RESISTENZA ELETTRICA
230V 40 W
Electrical resistance

Cod. 97150112

1 CUPOLA RETT. APRIBILE PC
Rectangular dome lid

Cod. 97150752

1 BASE ALTA IN MDF
C/PIANO IN ACCIAIO
High stand in mdf with steel border



Doppio vassoio porta uovo e verdure a doppia parete refrig. con cupola

Cod. 51132830

Double wall refrigerated GN tray with cover for eggs and vegetables.

Double plateau GN réfrigérant à double paroi avec cloche pour œufs et légumes.

Doppeltes Eier- und Gemüsetablett GN, doppelwandig, gekühlt mit Haube.

Bandeja doble GN porta-huevos y verduras con doble pared refrig. con campana.

Composizione

Cod. FBAF1220

1 VASSOIO PORTA UOVO
GN 1/2 C/FORCELLA
Egg tray with hooks

Cod. FBFF1240

1 BACINELLA GN 1/2 h 40
FORATA C/FORCELLA
Perforated basin with hooks

Cod. 5BP12065

2 BACINELLE GN PC 1/2 h 65
PC Gastronorm basin

Cod. 5FP12000

2 FALSI FONDI FORATI
GN PC 1/2
Perforated false bottom

Cod. 97150276

4 GEL PACK cm. 20x9,8
Refrigerating brick

Cod. 97150112

1 CUPOLA RETT. APRIBILE PC
Rectangular dome lid

Cod. 97150751

1 BASE BASSA IN MDF
Low base



Vassoio rettang. per affettati refrig. con cupola

Cod. 51130950

Rectangular refrigerated tray with cover for sliced salami.

Plateau rectangulaire réfrigérant avec cloche pour charcuterie.

Rechteckiges Tablett für gekühlten Aufschnitt mit Haube.

Bandeja rectangular para fiambre en lonchas refrigerado con campana.

Composizione

Cod. FBAF1120

1 BACINELLA GN 1/1 h 20
C/FORCELLE
Basin with hooks

Cod. 5TI11040

1 TEGLIA GN 1/1 h 40
Gastronorm basin

Cod. 5FP11000

1 FALSO FONDO FORATO
GN PC
Perforated false bottom

Cod. 97150276

4 GEL PACK cm. 20x9,8

Refrigerating brick

Cod. 97150112

1 CUPOLA RETT. APRIBILE PC
Rectangular dome lid

Cod. 97150751

1 BASE BASSA IN MDF
Low base



Vassoio forato porta burro e marmellata refrigerato Cod. 51133100

Perforated and refrigerated tray with cover for jam and butter.

Plateau percé réfrigérant avec cloche pour beurre et confiture.

Gelochtes Butter- und Marmelade-Tablett, gekühlt mit Haube.

Bandeja perforada para mantequilla y mermelada refrigerada con campana.



Porta brocche (completo di 3 brocche da 1,5 lt) a doppia parete refrigerato Cod. 51131A00

Refrigeret double wall 3 pieces jug holder (including 3 jugs of 1,5 liters each).

Porte-carafes réfrigérant à double paroi (complet de 3 carafes de 1.5 l).

Krughalter (komplett mit 3 Krügen zu 1,5 l), doppelwandig, gekühlt.

Porta-jarras (con 3 jarras de 1,5 l) con pared doble refrigerado.

Composizione

Cod. 5BA11040

1 BACINELLA GN 1/1 h 40
Gastronorm basin

Cod. F11F3310

1 VASSOIO PORTABURRO
C/FORCELLA
Butter tray with hooks

Cod. 5FP11000

1 FALSO FONDO FORATO
GN PC
Perforated false bottom

Cod. 97150276

4 GEL PACK cm. 20x9,8
Refrigerating brick

Cod. 97150112

1 CUPOLA RETT. APRIBILE PC
Rectangular dome lid

Cod. 97150751

1 BASE BASSA IN MDF
Low base

Composizione

Cod. 5BFB1120

1 BACINELLA FORATA
PER PORTA BROCCHE
Perforated tray for jugs

Cod. 5BP11100

1 BACINELLA PC 1/1
PC basin

Cod. 97200096

3 BROCCHE
VETRO BUFFET
lt. 1,5
Jug

Cod. 5FP11000

1 FALSO FONDO FORATO
GN PC
Perforated false bottom

Cod. 97150276

4 GEL PACK cm. 20x9,8
Refrigerating brick

Cod. 97150751

1 BASE BASSA IN MDF
Low base

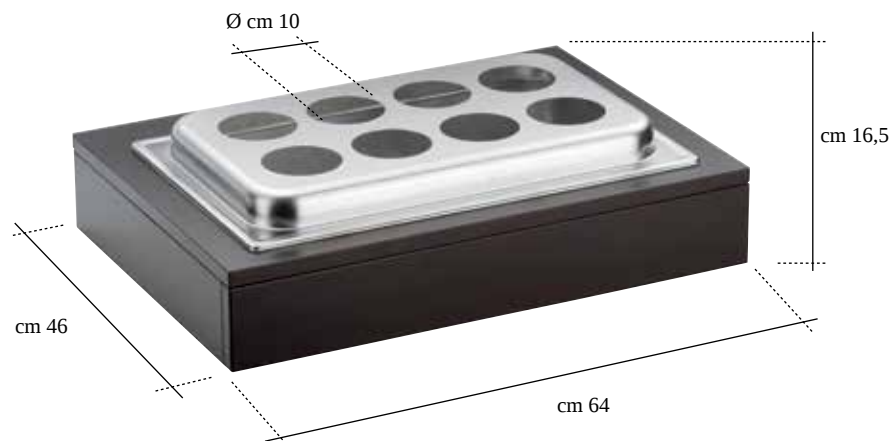

Porta bottiglie a doppia parete refrigerato

Cod. 51133700

Refrigeret double wall 8 pieces bottles holder.

Porte-bouteilles réfrigérant à double paroi.

Flaschenhalter, doppelwandig, gekühlt.

Porta-botellas con doble pared refrigerado.

Composizione

Cod. 30595559

1 VASCA BAGNOMARIA
1/1 h 110

Gastronorm bain marie basin
Cod. 5TFB1140
1 TEGLIA FORATA
PER PORTA BOTTIGLIE
Perforated tray for bottles

Cod. 5FP11000

1 FALSO FONDO FORATO
GN PC
Perforated false bottom

Cod. 97150276

4 GEL PACK cm. 20x9,8
Refrigerating brick

Cod. 97150751

1 BASE BASSA IN MDF
Low base



Porta yogurt e verdura a doppia parete refrigerato

Cod. 51132840

Double wall refrigeret basin with cover for yoghurt and vegetables.

Plateau réfrigérant double paroi avec cloche pour yaourt et légumes.

Joghurt- und Gemüseschalenhalter, doppelwandig, gekühlt mit Haube.

Porta-yogur y verduras con doble pared refrigerada con campana.

Composizione

Cod. D0595561

1 VASCA BAGNOMARIA
1/1 h 110 C/VITI
Gastronorm bain marie basin

Cod. 5BP13100

3 BACINELLE GN PC
1/3 h 100
PC Gastronorm basin

Cod. 5FF11000

1 FALSO FONDO GN
1/1 FORATO
Perforated false bottom

Cod. 97150276

4 GEL PACK cm. 20x9,8
Refrigerating brick

Cod. 97150112

1 CUPOLA RETT. APRIBILE PC
Rectangular dome lid

Cod. 97150751

1 BASE BASSA IN MDF
Low base



Porta verdura refrigerato Cod. 51132820

*Refrigerated basin with cover for vegetables.
Plateau légumes réfrigérant avec cloche.
Gemüeschalenhalter, gekühlt mit Haube.
Porta-verduras refrigerado con campana.*

Composizione

Cod. 5BP11065

1 BACINELLA GN PC
1/1 h 65

Gastronorm basin

Cod. FBAF2840

2 BACINELLE GN 2/8 h 40
SOVRAPP. C/FORCELLE
GN stackable basin with hooks

Cod. 5BA28040

2 BACINELLE GN 2/8 h 40
Gastronorm basin

Cod. 5FP11000

1 FALSO FONDO GN PC
1/1 h 65 FORATO
PC Perforated false bottom

Cod. 97150276

4 GEL PACK cm. 20x9,8
Refrigerating brick

Cod. 97150112

1 CUPOLA RETT. APRIBILE PC
Rectangular dome lid

Cod. 97150751

1 BASE BASSA IN MDF
Low base



Porta yogurt refrigerato con 22 spazi Cod. 51132900

*Refrigeret tray with 22 holes for yoghurt.
Porte-yaourt réfrigérant à 22 trous.
Joghurthalterschale, gekühlt mit 22 Plätzen.
Porta-yogur refrigerado con 22 compartimentos.*

Composizione

Cod. 5BP11065

1 BACINELLA GN PC
1/1 h 65
PC Gastronorm basin

Cod. 5BFY1120

1 BACINELLA FORATA
PER PORTA YOGURT
Perforated tray for yoghurt

Cod. 5FP11000

1 FALSO FONDO FORATO
GN PC
Perforated false bottom

Cod. 97150276

4 GEL PACK cm. 20x9,8
Refrigerating brick

Cod. 97150751

1 BASE BASSA IN MDF
Low base



Alzata 3 piani con vassoi quadrati GN 2/3 refrigerata Cod. 51131058

3 levels fixed cooled stand with GN 2/3 squared tray.

Etagère fixe 3 niveaux avec plateaux carrés GN 2/3 (congelée).

3-Etagen-Etagere mit rechteckigen Tablett GN 2/3 gekühlt.

Presentador de 3 pisos con bandejas cuadradas GN 2/3 refrigerado.

Composizione

Cod. 5BA23020
3 BACINELLE GN
2/3 h 20

Gastronorm basin

Cod. 5BA23040
3 BACINELLE GN
2/3 h 40

Gastronorm basin

Cod. 5FF23000
3 FALSI FONDI FORATI
GN 2/3

Perforated GN False bottom

Cod. 97150276

6 GEL PACK cm. 20x9,8
Refrigerating brick

Cod. 97150775

1 ALZATA 3 PIANI IN MDF
3 levels fixed stand

Optional

Cod. 97150782

CUPOLA PC PER BACINELLA
GN 2/3

cm 36x40x15
PC GN 2/3 basin cover lid.



Alzata 2 piani refrigerata con doppia cupola Cod. 51131054

Refrigerated double deck rectangular trays with covers.

Plateau à deux étages réfrigérés avec cloche.

2 Etagen-Etagere mit rechteckigen Tablett mit Rolltop, gekühlt.

Presentador de dos pisos refrigerado con doble campana.

Composizione

Cod. FBAF1120
2 BACINELLE GN 1/1 h 20
C/FORCELLA

Gastronorm bain marie
with hooks

Cod. 5TI11040
2 TEGLIA GN 1/1 h 40
Gastronorm basin

Cod. 5FP11000
2 FALSO FONDO FORATO PC
Perforated PC false bottom

Cod. 97150276

8 GEL PACK cm. 20x9,8
Refrigerating brick

Cod. 97150112

2 CUPOLE RETT. APRIBILE PC
Rectangular dome lid

Cod. 97150754

1 ALZATA DOPPIA IN MDF
Double deck trays



Vassoio pasticceria con cupola Cod. 51130920

*Rectangular tray with cover for pastries.
Plateau rectangulaire à pâtisserie.
Rechteckiges tablett 1/1 mit rolltop.
Bandeja rectangular para pastelería.*

Composizione

Cod. FBAF1120
1 BACINELLA GN
1/1 h 20 C/FORCELLA
Gastronorm basin with hooks
Bac gastronorm avec crochets

Cod. 97150112
1 CUPOLA RETT. APRIBILE PC
Rectangular dome lid

Cod. 97150751
1 BASE BASSA IN MDF
Low base



Vassoio per formaggi con tagliere in polietilene Cod. 51130940

*Rectangular cheese tray with non-deformable polyethylene board.
Plateau à fromages avec planche à découper en polyéthylène.
Rechteckiges Kaesetablett 1/1 aus Polyethylen mit Rolltop, hoher Widerstand.
Bandeja rectangular para queso con tabla de polietileno.*

Composizione

Cod. FBAF1120
1 BACINELLA GN
1/1 h 20 C/FORCELLA
Gastronorm basin with hooks

Cod. 97150174
1 TAGLIERE IN POLIETILENE
NERO
cm 50x30x2,3
Polyethylene board

Cod. 97150112
1 CUPOLA RETT. APRIBILE PC
Rectangular dome lid

Cod. 97150751
1 BASE BASSA IN MDF
Low base

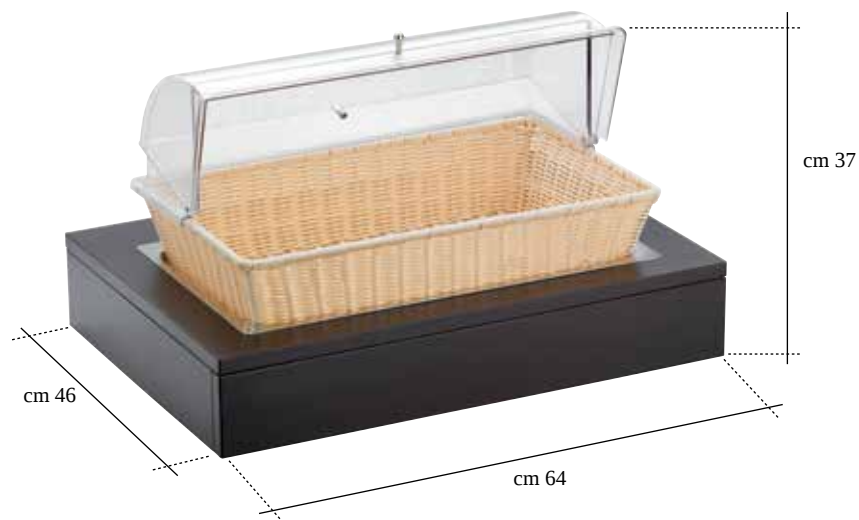

Cesta pane paglia con cupola

Cod. 51136700

Paill bread basket with cover.

Corbeille à pain avec cloche.

Brotkorb mit Haube.

Cesto para el pan con campana.

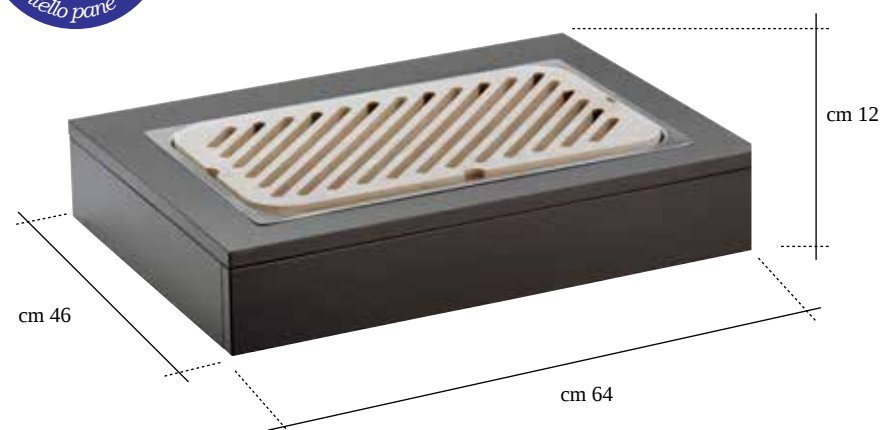

Tagliere pane

Cod. 51136800

Bread board.

Planche à couper le pain.

Scneidbrett.

Tabla de cortar pan.

Composizione

Cod. 5TI11040
1 TEGLIA 1/1 h 40
Gastronorm basin

Cod. L7150760
1 CESTA PANE PAGLIA
C/FORCELLE
Paill bread basket with hooks

Cod. 97150112
1 CUPOLA RETT.
APRIBILE PC
Rectangular dome lid

Cod. 97150751
1 BASE BASSA IN MDF
Low base



Cod. 51136900
CESTA PANE WENGE CON CUPOLA
Wenge bread basket with cover

Composizione

Cod. 5TI11020
1 TEGLIA GN 1/1 h 20
Gastronorm basin

Cod. 97150164
1 TAGLIERE PANE
IN LEGNO NATURALE
Wood bread board

Cod. 97150751
1 BASE BASSA IN MDF
Low base

Optional

Cod. 741000EM
COLTELLO PANE PROFESSIONAL
cm. 20
Professional bread knife.

Cod. 741000E5
COLTELLO PANE PROFESSIONAL
cm. 28
Professional bread knife.



Porta champagne / Doppia punch bowl 7 lt Cod. 51132600

*Champagne holder - Double punch bowl.
Plateau pour champagne - Double punch bowl.
Champagner-Kübel - Doppeltes Punch Bowl.
Porta-champagne - Doble punch bowl.*

Composizione

Cod. 30505559
1 VASCA CHAFING DISH
1/1 h 110
Chafing dish basin

Cod. 5TFC1140
1 TEGLIA FORATA
PER PORTA CHAMPAGNE
Perforated tray for champagne

Cod. F1132600
2 PENTOLE PORTA
CHAMPAGNE lt. 7
Champagne pot

Cod. 97150751
1 BASE BASSA IN MDF
Low base



Vassoio porta porcellane Cod. 51132700

*Chinaware (porcelain) holder.
Plateau à porcelaines.
Tablett für Porzellanteile.
Bandeja porta-porcelanas.*

Composizione

Cod. 97150755
1 VASSOIO PER
PORCELLANE IN MDF
Chinaware holder

Cod. 97150751
1 BASE BASSA IN MDF
Low base

Optional

PER COMPLETARE IL
VASSOIO:

Cod. 97150170
8 PORCELLANE cm. 8x8x4

Cod. 97150171
3 PORCELLANE cm. 13x13x4,5

Cod. 97150172
2 PORCELLANE cm. 16x16x6

Cod. 97150173
2 PORCELLANE cm. 20x12,5x6

To complete the tray the following
pieces of china are necessary:

8 chinaware cm 8x8x4
3 chinaware cm 13x13x4.5
2 chinaware cm 16x16x6
2 chinaware cm 20x 12.5x6



**Vassoio
porta posate
Cod. 51133900**

*Cutlery containers.
Plateau double en bois.
Besteckschalen-Aufnahmetablett.
Bandeja porta-cubiertos.*

Composizione

Cod. 30595559
1 VASCA BAGNOMARIA
PER CHAFING DISH 1/1 h 110
Gastronorm bain marie basin

Cod. FBAF2865
2 BACINELLE GN 2/8 h 65
C/FORCELLA
Gastronorm basin with hooks

Cod. 5BA28065
2 BACINELLE GN 2/8 h 65
Gastronorm basin

Cod. 97150112
1 CUPOLA RETT. APRIBILE PC
Rectangular dome lid

Cod. 97150751
1 BASE BASSA IN MDF
Low base



**Alzata 2 piani con vassoi per pasticceria
con doppia cupola
Cod. 51131055**

*Double deck rectangular trays with covers for pastries.
Plateau à 2 étages avec plateaux rectangulaires pour pâtisserie et double cloche.
2 Etagen-Etagere mit rechteckigen Tablett für Backwaren mit doppelter Haube.
De 2 pisos con bandejas rectangulares para pasteles con doble campana.*

Composizione

Cod. FBAF1120
2 BACINELLE GN 1/1 h 20
C/FORCELLA
Gastronorm bain marie with hooks

Cod. 97150112
2 CUPOLE RETT. APRIBILE PC
Rectangular dome lid

Cod. 97150754
1 ALZATA DOPPIA IN MDF
Double deck trays



Porta frutta
a 2 piani
Cod. 51131056

*Double dack trays for fruit.
Fruitier à 2 étages avec base.
2 Etagen-Obstschale mit basis.
Frutero de 2 pisos con base.*

Composizione

Cod. 5TIR1120
1 TEGLIA GN
1/1 h 20 C/RINGHIERE
GN tray with edges

Cod. 5TIR1140
1 TEGLIA GN
1/1 h 40 C/RINGHIERE
GN tray with edges

Cod. 97150754
1 ALZATA DOPPIA IN MDF
Double deck trays



Alzata 3 piani
con vassoi quadrati GN 2/3
Cod. 51131057

*3 levels fixed stand with GN 2/3 squared tray.
Etagère fixe 3 niveaux avec plateaux carrés GN 2/3.
3-Etagen-Etagere mit rechteckigen Tablettis GN 2/3.
Presentador de 3 pisos con bandejas cuadradas GN 2/3.*

Composizione

Cod. 5BA23020
3 BACINELLE GN 2/3 h 20
Gastronorm basin

Cod. 97150775
1 ALZATA 3 PIANI IN MDF
3 levels fixed stand

Optional

Cod. 97150782
CUPOLA PC PER BACINELLA
GN 2/3
cm 36x40x15
PC GN 2/3 basin cover lid.



Distributore bevande calde con resistenza elettrica

230 Volt 240 Watt Ø 24 cm lt 8

Cod. 51139527

Hot drinks dispenser provided with electric resistance.

Distributeurs de boissons chaudes avec résistance électrique.

Spender für warme getränke ausgestattet mit elektrischer heizung.

Distrbuidores de bebidas calientes con resistencia eléctrica.

Composizione

Cod. F0959524

1 DISTRIB. BEV. CALDE
C/MANIGLIA cm. 24 lt. 8
Hot drink dispenser

Cod. 5BA16020

1 BACINELLA GN 1/6 h 20
Gastronorm basin

Cod. 50902613

1 GRIGLIA 1/6 PER DISTRIB.
Grill for dispenser.

Cod. 50959522

1 COPERCHIO PER
DISTRIB. LATTE SAMOVAR
Lid for Samovar milk dispenser

Cod. 97150221

1 RUBINETTO SMONTABILE
IN PPL TOMLINSON
Tomlinson PPL faucet

Cod. 97150119*

1 RESISTENZA ELETRICA
C/ REGOLATORE
230V 240 W
Electric resistance

Cod. H2959523

1 PORTA RESISTENZA
Stand for electric resistance

Cod. 97150758

1 STRUTTURA IN MDF PER
DISTRIB. BEV. CALDE
Structure for hot drink dispenser



Distributore succhi e bevande con colonna refrigerante e rubinetto Tomlinson

Ø 20 cm lt 9,5

Cod. 51135420

Juice and cold drink dispenser with refrigerating pipe for ice cubes.

Fontaine à jus de fruits simple paroi et colonne porte-glaçons.

Spender für Saft und kalte Getränke.

Surtidor de zumos y bebidas con tubo para hielo y grifo Tomlinson.

Composizione

Cod. 97150039

1 CONT. BEV. CON RUB.
TOMLINSON
cm. 20 lt. 9,5
Juice dispenser with Tomlinson tap

Cod. 50955421

1 COPERC. C/POMOLO cm. 20
Lid with knob

Cod. 93191076

1 PERNO DI BLOCCAGGIO
Lockpin

Cod. 5BA16020

1 BACINELLA GN 1/6 h 20
Gastronorm basin

Cod. 50902613

1 GRIGLIA 1/6 PER DISTRIB.
Grill for dispenser.

Cod. 97150757

1 STRUTTURA IN MDF PER
DISTRIB. SUCCHI
Structure for juice dispenser

Novità

Cod. L7150248 Ø cm 5 lungh cm 35
TUBO REFRIGERANTE
Refrigerant tube.

Cod. 97150248

ANELLO PER TUBO REFRIGERANTE
Ring for refrigerant tube.



Distributore succhi e bevande con
colonna refrigerante e rubinetto Tomlinson

Ø 16 cm lt 4,5

Cod. 51135413

Juice and cold drink dispenser with refrigerating pipe for ice cubes.

Fontaine à jus de fruits simple paroi et colonne porte-glaçons.

Spender für Saft und kalte Getränke.

Surtidor de zumos y bebidas con tubo para hielo y grifo Tomlinson.

Composizione

Cod. 97150038

1 CONT. BEV. CON RUB.

TOMLINSON

cm. 16 lt. 4,5

Juice dispenser with Tomlinson tap

Cod. 50955417

1 COPERC. C/POMOLO cm. 16

Lid with knob

Cod. 93191077

1 PERNO DI BLOCCAGGIO

Lockpin

Cod. 5BA16020

1 BACINELLA GN 1/6 h 20

Gastronorm basin

Cod. 50902613

1 GRIGLIA 1/6 PER DISTRIB.

Grill for dispenser.

Cod. 97150767

1 STRUTTURA IN MDF PER

DISTRIB. SUCCHI

Structure for juice dispenser.

Novità

Cod. L7150247 Ø cm 5 lungh cm 27,5

TUBO REFRIGERANTE

Refrigerant tube.

Cod. 97150247

ANELLO PER TUBO REFRIGERANTE

Ring for refrigerant tube.



Distrib. doppio succhi e bevande con
colonna refrigerante e rubinetto Tomlinson

Ø 16 cm lt 4,5x2

Cod. 51135416

Double juice and cold drink dispenser with refrigerating pipe for ice cubes.

Fontaine à jus de fruits simple paroi et colonne porte-glaçons, double.

Doppelter Spender für Saft und kalte Getränke

Surtidor de zumos y bebidas doble con tubo para hielo y grifo Tomlinson.

Composizione

Cod. 97150038

2 CONT. BEV. CON RUB.

TOMLINSON

cm. 16 lt. 4,5x2

Juice dispenser with Tomlinson tap

Cod. 50955417

2 COPERC. C/POMOLO cm. 16

Lid with knob

Cod. 93191077

2 PERNO DI BLOCCAGGIO

Lockpin

Cod. 5BA16020

2 BACINELLE GN 1/6 h 20

Gastronorm basin

Cod. 50902613

2 GRIGLIE 1/6 PER DISTRIB.

Grill for dispenser.

Cod. 97150768

1 STRUTTURA IN MDF DOPPIA

PER DISTRIB. SUCCHI

Double structure for juice dispenser.

Novità

Cod. L7150247 Ø cm 5 lungh cm 27,5

TUBO REFRIGERANTE

Refrigerant tube.

Cod. 97150247

ANELLO PER TUBO REFRIGERANTE

Ring for refrigerant tube.

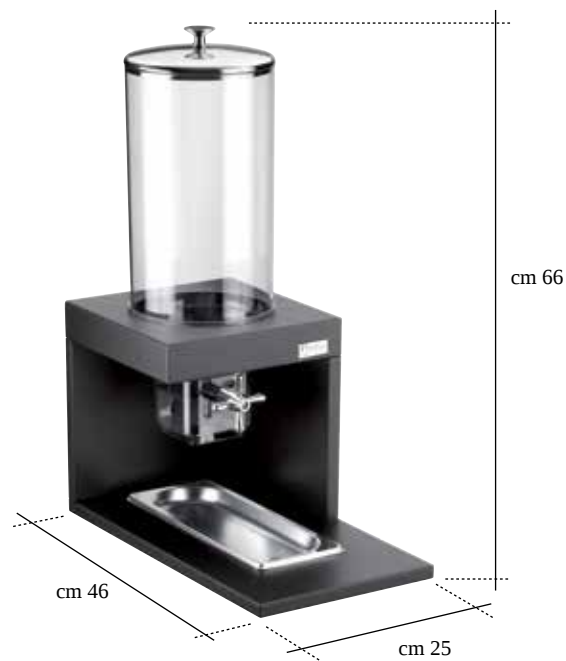

Distributore cereali

Ø 18 cm lt 8

Cod. 51139818

*Cereal dispenser.
Distributeur à céréales.
Cerealien-Spender.
Dispensador de cereales.*

Composizione

Cod. 97150052
1 DISTRIB. CEREALI
C/COPERCHIO cm.18 lt. 8
Cereal dispenser with lid

Cod. 5BA28020
1 BACINELLA 2/8 h 20
Gastronom basin

Cod. 97150756
1 STRUTTURA PER
DISTRIB. CEREALI
Structure for cereal dispenser



Distributore doppio cereali

Ø 18 cm lt 8x2

Cod. 51139819

*Double cereal dispenser.
Distributeur double à céréales.
Doppelter Cerealien-Spender.
Dispensador doble de cereales.*

Composizione

Cod. 97150052
2 DISTRIB. CEREALI
C/COPERCHI cm.18 lt. 8x2
Cereal dispenser with lid

Cod. 5BA28020
2 BACINELLA 2/8 h 20
Gastronom basin

Cod. 97150769
1 STRUTTURA DOPPIA
PER DISTRIB. CEREALI
Double structure for cereal dispenser



Carrelli

BE SMART BUY SMART!



**DA MONTARE.
TO BE
ASSEMBLED.**

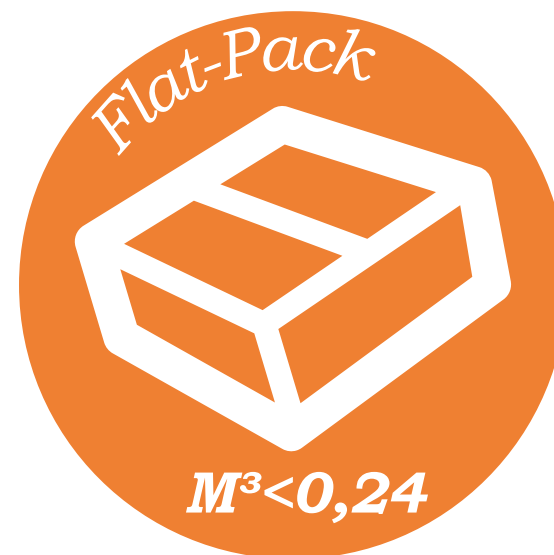

Ogni prodotto è confezionato in scatola con fascetta personalizzata.
Volume massimo di spedizione 0,24 mc
*Each product is packed in a single box with sleeve.
Maximum volume of shipment 0,24 mc*

*maneggevole, elegante, funzionale.
handy, smart, functional.*

Componentistica: vedi pag. / Technical card: see page / Fiches techniques: voir page / Technische karten: Siehe Seite / Tarjetas técnicas: ver pagina 166
Note Informativa: vedi pag. / Technical information: see page / Notes d'information: voir page / Hinweise teile: Siehe Seite / Notas informativas: ver pagina 180
Acciaio Inossidabile 18/10 & Nobilitato / Stainless steel 18/10 & Laminated Wood / Acier 18/10 & / Edelstahl 18/10 & Ausgewaltz / Acero 18/10 & Laminado





Carrello servire Smart

Cod. 97150850

Smart serving trolley

Chariot à desserte Smart

Servierwagen Smart

Carrito para servir Smart

SIZE BOX cm 95x63,5x21,5h

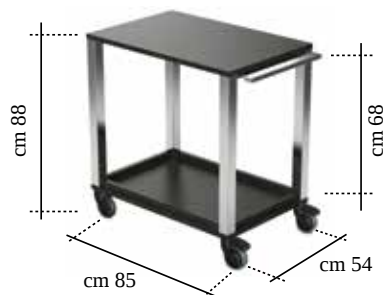

Base Jumbo Smart componibile con cup.

Cod. 97150855

Rectangular tray with cloche

Plateau rectangulaire avec cloche

Anbaubasis Jumbo Smart mit Kuppel

Base Jumbo Smart con campana

SIZE BOX cm 90,5x66,5x39,5h

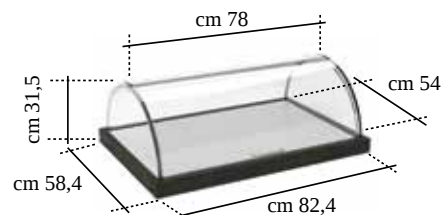

Carrello Jumbo Smart

Cod. 97150854

Smart Jumbo serving trolley

Chariot à desserte Smart Jumbo

Servierwagen Smart Jumbo

Carrito para servir Smart Jumbo

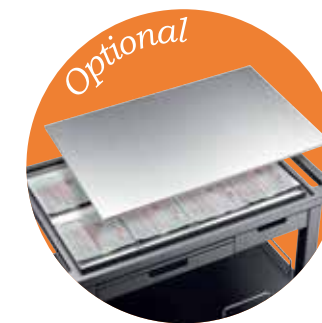

Optional

Kit refrigerato con coperture in acciaio e gel pack

Cod. 97150746

75,5x49,5x1,3 cm

Stainless steel kit of refrigerating bricks.

~

Si utilizza con Base Jumbo Smart componibile con cup.

To be used with the rectangular tray.

À utiliser avec le plateau rectangulaire.

Man benutzt mit Anbaubasis Jumbo Smart mit Kuppel.

Se utiliza con Base Jumbo Smart.

Cod. 97150855

Cod. 97150855

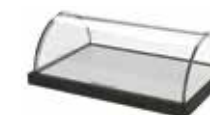

Cod. 97150850

Componentistica: vedi pag. / Technical card: see page / Fiches techniques: voir page / Technische karten: Siehe Seite / Tarjetas tecnicas: ver pagina 166

Note Informativa: vedi pag. / Technical information: see page / Notes d'information: voir page / Hinweise teile: Siehe Seite / Notas informativas: ver pagina 180

Acciaio Inossidabile 18/10 & Nobilitato / Stainless steel 18/10 & Laminated Wood / Acier 18/10 & / Edelstahl 18/10 & Ausgewaltz / Acero 18/10 & Laminado





Carrello Gueridon Smart

Cod. 97150851

Smart Gueridon serving trolley
Chariot à desserte Gueridon Smart
Servierwagen Gueridon Smart
Carrito para servir Gueridon Smart
SIZE BOX cm 95x63,5x21,5h

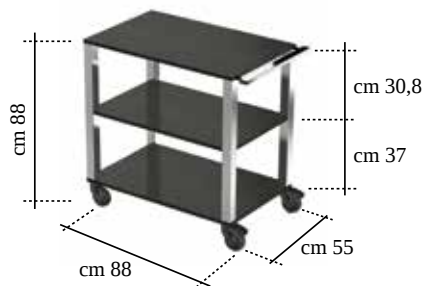

Carrello appoggio Smart

Cod. 97150853

Smart food serving trolley
Chariot de service Smart
Servierwagen Smart
Carrito para servir Smart
SIZE BOX cm 78,5x53,5x16,5h



Carrello drink Smart

Cod. 97150852

Smart drink serving trolley
Chariot Smart drink
Servierwagen Smart drink
Carrito Smart drink
SIZE BOX cm 107,5x67,5x23,5h





**Carrello servire
Gueridon**

Cod. 97150739

*Gueridon serving trolley
Chariot à desserte Gueridon
Servierwagen Gueridon
Carrito para servir Gueridon*

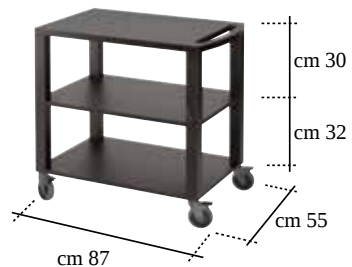

**Carrello servire
con piano estraibile**

Cod. 97150740

*Food serving trolley, with openable shelf
Chariot de service avec plan coulissant
Servierwagen mit ausnehmbarem Teil
Carrito para servir con tabla extraible*

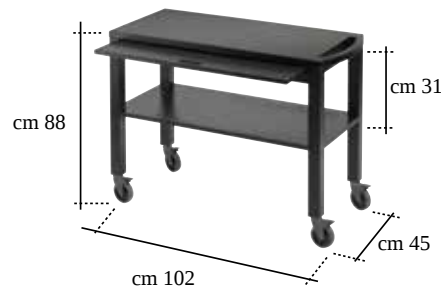

**Carrello servire caldo
c/piano in acciaio**

Cod. 97150741

*Stainless steel serving trolley for hot food
Chariot de service réchauffant avec plan
recouvert en acier
Edelstahlservierwagen für warme Speisen
Carrito para servir caliente con
plancha superior en acero*



**Carrello doppio jolly
(anche per Refrigerati)**

Cod. 97150742

*Multipurpose double serving tray
Chariot double à plusieurs usages
Doppelter Servierwagen für
verschiedene Anwendungen
Carrito doble diversos usos*

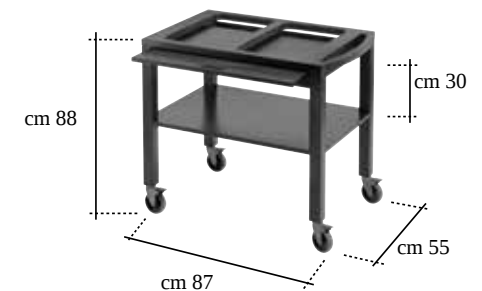



Carrello appoggio

Cod. 97150736

Food serving trolley
Chariot de service
Servierwagen
Carrito para servir

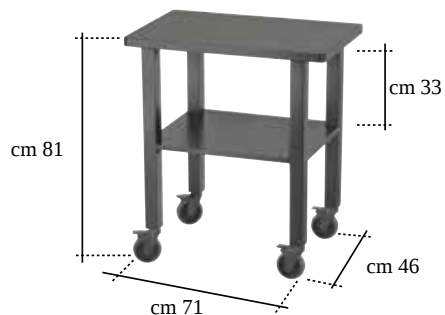

Carrello apribile multifunzionale

Cod. 97150737

Multipurpose food serving trolley, openable
Chariot ouvrant
Servierwagen, offenbar, für verschiedene Anwendungen
Carrito multifuncional con tabla superior extraible

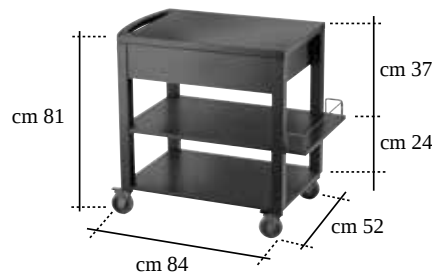

Carrello dolci e formaggi con cupola

Cod. 97150735

Cheese - cake serving trolley with cloche
Chariot à gateaux/fromages avec cloche
Kuchen- Kaeseservierwagen mit Rolltop
Carrito postres/queso con campana

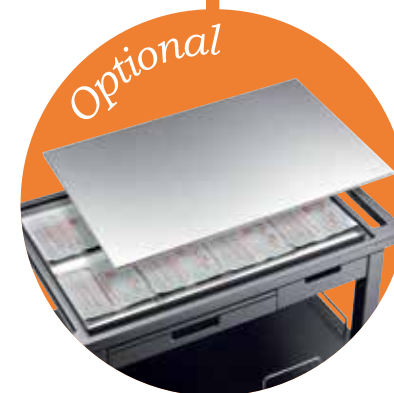

Optional

Optional

Kit refrigerato con coperture in acciaio e gel pack
 Cod. 97150746
 75,5x49,5x1,3 cm
Stainless steel kit of refrigerating bricks.

Cupola per carrello dolci e formaggi

Cod. 97150781
 cm 78x54x27

Cloche for cheese - cake serving trolley.

*Per completare i Vassoi
multistrato porta
bacinelle GN*

VASSOIO PORTA BACINELLE
GN 1/2

Cod. 5BA12065

- 1 BACINELLA GN 1/2 h 65
- Gastronorm basin
- Bac gastronorm
- Durchbrochener basis
- Cubeta gastronormic

OPPURE OR

Cod. 5BA14065

- 2 BACINELLA 1/4 h 65
- Gastronorm basin
- Bac gastronorm
- Durchbrochener basis
- Cubeta gastronormic

VASSOIO PORTA BACINELLE
GN 1/1

Cod. 5BA11065

- 1 BACINELLA GN 1/1 h 65
- Gastronorm basin
- Bac gastronorm
- Durchbrochener basis
- Cubeta gastronormic

OPPURE OR

Cod. 5BA12065

- 2 BACINELLA 1/2 h 65
- Gastronorm basin
- Bac gastronorm
- Durchbrochener basis
- Cubeta gastronormic





Vassoio multistrato
porta bacinelle
GN 1/2
impilabile
cm 34x28x8

Cod. 97160720

Basin tray, stackable.

Plateau superposable porte bac.

Schuesselhalter, stapelbar.

Bandeja multicapa apilable.



Vassoio multistrato
porta bacinelle
GN 1/1
impilabile
cm 54x34x8

Cod. 97160721

Basin tray, stackable.

Plateau superposable porte bac.

Schuesselhalter, stapelbar.

Bandeja multicapa apilable.



Vassoio da portata
misura 1/1
impilabile
cm 60x40x6

Cod. 97150780

Basin tray Mod 1/1, stackable.

Plateau porte- bac gastronorm 1/1.

Schuesselhalter Mod 1/1, stapelbar.

Bandeja G/N 1/1 apilable.

Composizione

Cod. 97200099

24 CIOTOLE IN VETRO

Ø cm. 12

Glass bowls

Bols en verre

Glasschuessel

Cuencos en vidrio

Cod. 97150798

1 BASE PER PORTACIOTOLE 24 PZ

Glassholder.

Base pour porte-bols

Tablett für Glasschuessel

Base por pota-cuencos

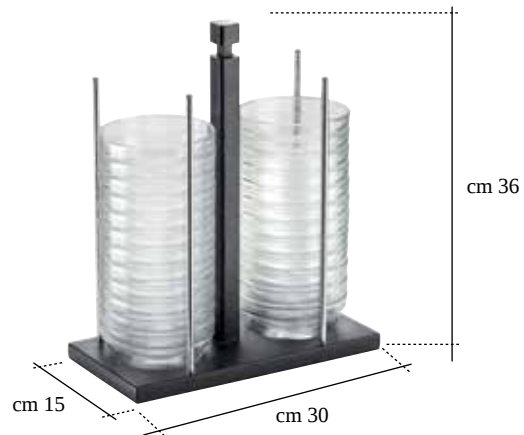

Portaciotole 24 pz. ciotola in vetro Ø cm 12

Cod. 51133424

Chinaware (glass) holder.

Porte-bols en verre

Schuesselset 24 tlg.

Porta-cuencos en vidrio.

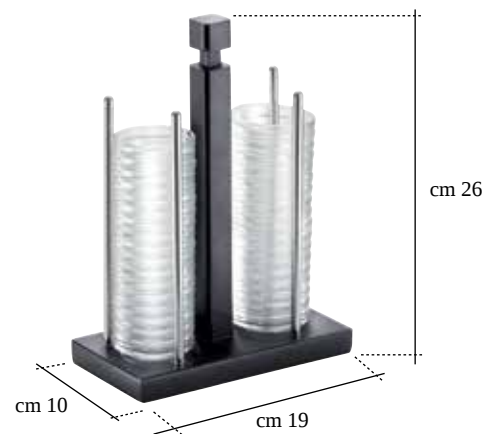

Portaciotole 36 pz. ciotola in vetro Ø cm 6

Cod. 51133436

Chinaware (glass) holder.

Porte-bols en verre

Schuesselset 36 tlg.

Porta-cuencos en vidrio.

Composizione

Cod. 97200098

36 CIOTOLE IN VETRO

Ø cm. 6

Glass bowls

Bols en verre

Glasschuessel

Cuencos en vidrio

Cod. 97150799

1 BASE PER PORTACIOTOLE 36 PZ

Glassholder

Base pour porte-bols

Tablett für Glasschuessel

Base por pota-cuencos

PINTI buffet
made in
Italy

Potaciotole Chinaware holder



Show Food

Gli Show Food Buffet sono ideali per organizzare allestimenti speciali, aperitivi, cocktail party, rinfreschi e splendidi buffet.

The items of the Show Food Buffet line are ideal for special events, appetizers, cocktail parties, receptions and wonderful buffets.

Il design coniuga creatività, eleganza e professionalità.

The design is a mix of creativity, elegance and professional competence.

Gli Show Food Buffet esprimono le tendenze glamour della ristorazione e del libero servizio.

The Show Food Buffet express the new glam trends in catering and service.





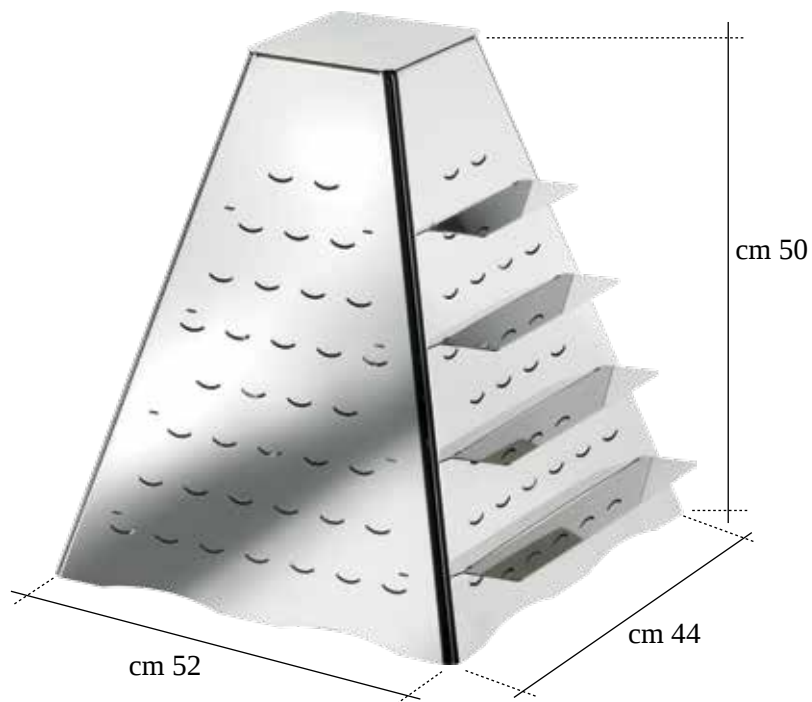

Porta Zakouski
144 pz. a piramide
con 8 mensole removibili
in aisi 304

kg 7,850

Cod. 51133899

144 pcs. pyramid Zakouski holder with applicable inserts.

Présentoir Zakouski 144 pièces pyramidal avec étagères applicables.

Pyramidaler Zakouski-Halter 144-teiling mit einsetzbaren Konsolen.

Porta-Zakouski 144 pz. de pirámide con repisas aplicables.

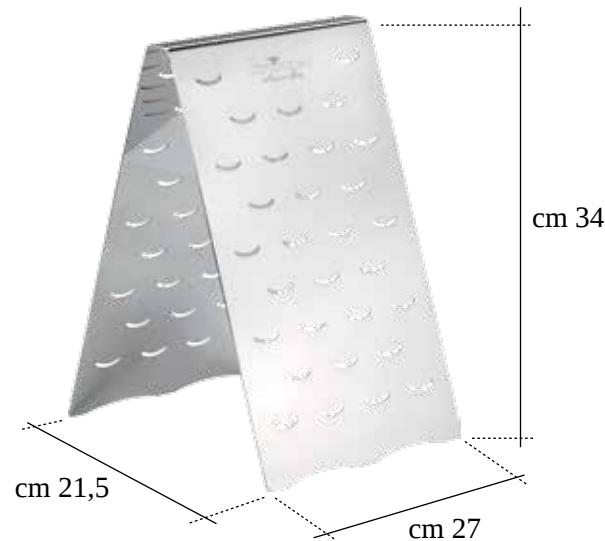

Porta Zakouski
60 pezzi
in aisi 304

Cod. 51013860

60 pieces Zakouski holder.

Présentoir Zakouski 60 pièces.

Zakouski-Halter 60-teilig.

Porta-Zakouski 60 piezas.

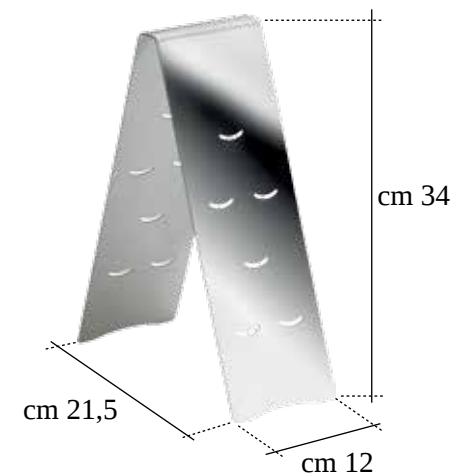

Porta Zakouski
12 pezzi
in aisi 304

Cod. 51133812

12 pieces Zakouski holder.

Présentoir Zakouski 12 pièces.

Zakouski-Halter 12-teilig.

Porta-Zakouski 12 piezas.



Porta
Zakouski
Evoluzione
in aisi 304
cm. 8x5,5x15

Cod. 51013861

*Zakouski holder.
Présentoir Zakouski.
Zakouski-Halter.
Porta-Zakouski.*



Cucchiaio
Zakouski
Evoluzione
in aisi 304

Cod. 299000AT

*Evoluzione Zakouski spoon.
Cuillère Zakouski Evoluzione.
Zakouski-Löffel Evoluzione.
Cuchara Zakouski Evolución.*



Cucchiaio
Zakouski
Evoluzione
in aisi 430

Cod. 299300AT

*Evoluzione Zakouski spoon.
Cuillère Zakouski Evoluzione.
Zakouski-Löffel Evoluzione.
Cuchara Zakouski Evolución.*



Cucchiaio
Zakouski
Hotel
in aisi 304

Cod. 202000AT

*Hotel Zakouski spoon.
Cuillère Zakouski Hotel.
Zakouski-Löffel Hotel.
Cuchara Zakouski Hotel.*



Cucchiaio
Zakouski
Gamma
in aisi 304

Cod. 215000AT

*Gamma Zakouski spoon.
Cuillère Zakouski Gamma.
Zakouski-Löffel Gamma.
Cuchara Zakouski Gamma.*



Carosello portavivande con base girevole

50x70 cm

Cod. 50951554

Food-hamper carousel with turnable base.

Carrousel porte-aliments à base tournante.

Speisenkarussell.

Carrusel porta-alimentos de base giratoria.

Composizione

Cod. 97200080

3 CIOTOLE IN VETRO
INFRANGIBILE
Ø cm 23 lt 3
Unbreakable glass bowls

Cod. 97200082

3 CIOTOLE IN VETRO
INFRANGIBILE
Ø cm 26 lt 4
Unbreakable glass bowls

Cod. 97200081

3 COPERCHI PER CIOTOLE
Ø cm 23
Openable polycarbonate lid

Cod. 97200083

3 COPERCHI PER CIOTOLE
Ø cm 26
Openable polycarbonate lid

Cod. 50951552

1 STRUTTURA CAROSELLO
Ø cm 50 h cm 70
Food-hamper carousel



Porta muesli con coperchio in policarbonato

48x46 cm h 23 cm

Cod. 50951P48

Muesli holder with polycarbonate openable lid

Réceptient à muesli avec couver. ouvrable en polycarb.

Müsli-halter mit klappdeckel aus polycarbonat

Recipiente para muesli con tapa abrible de policarb.

Composizione

Cod. 97200081

3 COPERCHI PER CIOTOLE
Ø cm 23
Openable polycarbonate lid

Cod. 97200082

3 CIOTOLE IN VETRO
INFRANGIBILE
Ø cm 26 lt 3
Unbreakable glass bowls



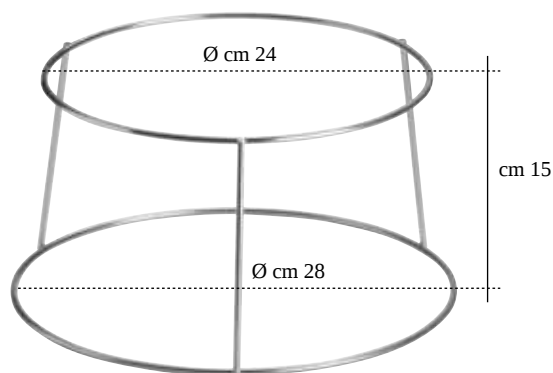

**Alzata filo
piccola**

24/28 Ø cm h 15 cm

Cod. 50951028

*Riser
Presentoir
Etagère
Frutero*

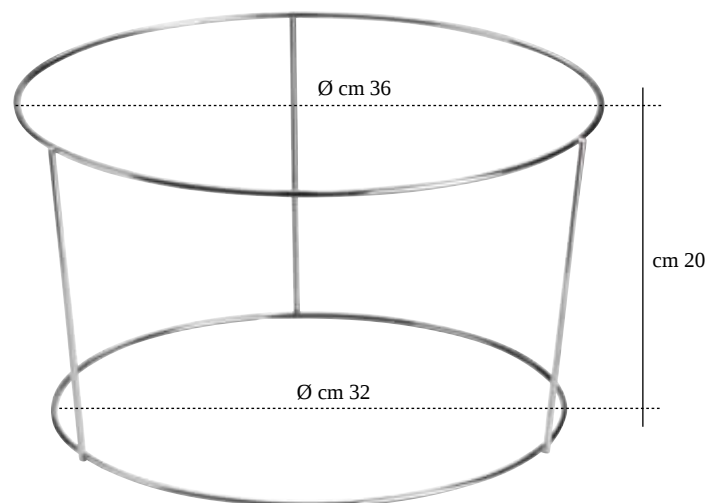

**Alzata filo
grande**

32/36 Ø cm h 20 cm

Cod. 50951036

*Riser
Presentoir
Etagère
Frutero*



Optional

Vassoio tondo
cameriere
Tender

Cod. 538259..

Ø cm 24
Ø cm 28
Ø cm 32
Ø cm 36
Round tray Tender



Porta torte
3 posti

54x49 cm h 18,5 cm

Cod. 51001557

Cake display

Étagère 3 niveaux

Ständer für torten

Fuente alta 3 niveles



Alzata /
Porta torta singola

26 Ø cm h 4,5 cm

Cod. 50951030

Cake display

Etagère

Tortenstaender

Fuente alta postre



**Alzata fissa
2 piani**

40/30 Ø cm h 50 cm

Cod. 50951040

Fixed 2-level riser.

Presentoir fixe 2 niveaux.

Etagère 2-stöckig.

Frutero alta fija 2 niveles.

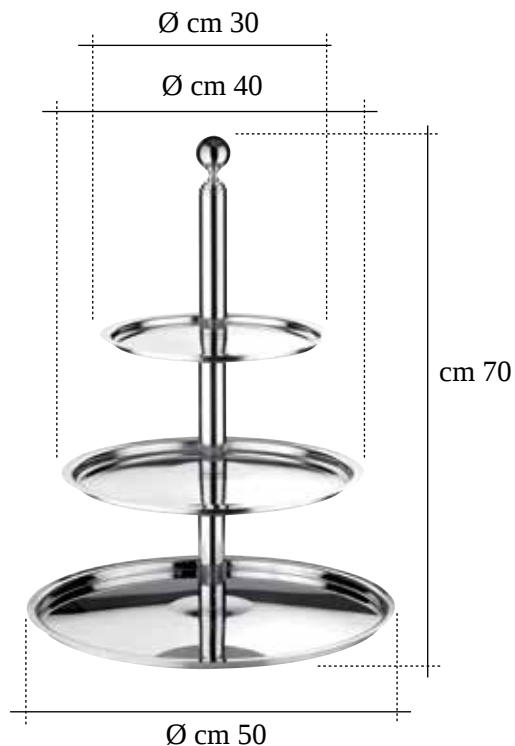

**Alzata fissa
3 piani**

50/40/30 Ø cm h 70 cm

Cod. 50951050

Fixed 3-level riser.

Presentoir fixe 3 niveaux.

Etagère 3-stöckig.

Frutero alta fija 3 niveles.



**Alzata fissa
3 piani con cesto**

50/40/30/25 Ø cm h 73 cm

Cod. 50951051

Fixed 3-level riser with basket.

Presentoir fixe 3 niveaux avec corbeille.

Etagère 3-stöckig mit korb.

Frutero alta fija 3 niveles con cesto.





Alzata girevole 2 piani

43/34 Ø cm h 50 cm

Cod. 50951542

Turnable 2-level riser

Présentoir tournant 2 niveaux

2-Etagen-drehaufsatz

Frutero alta giratoria 2 niveles

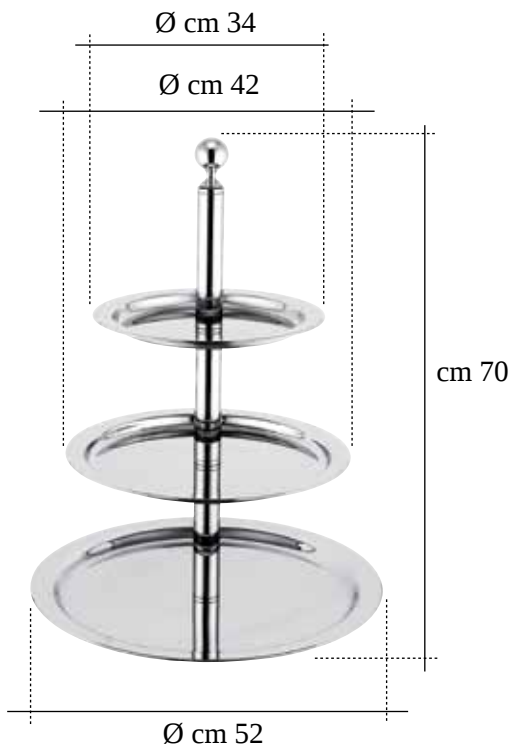

Alzata girevole 3 piani

52/42/34 Ø cm h 70 cm

Cod. 50951550

Turnable 3-level riser

Présentoir tournant 3 niveaux

3-Etagen-drehaufsatz

Frutero alta giratoria 3 niveles



Alzata girevole 3 piani con cesto

43/34 Ø cm h 50 cm

Cod. 50951549

Turnable 3-level riser with basket

Présentoir tournant 3 niveaux avec corbeille

3-Etagen-drehaufsatz mit korb

Frutero alta giratoria 3 niveles con cesto



Supreme bowl doppia parete con coperchio e ciotola in vetro infragibile

Cod. 50951925

26 Ø cm 24 h cm

Cod. 50951934

374 Ø cm 32 h cm

Supreme bowl, double wall with lid and unbreakable glass bowl.

Supreme bowl double paroi avec couvercle et bol en verre incassable.

Supreme bowl doppelwand mit deckel und unzerbrechlicher glasschüssel.

Supreme bowl doble pared con tapa y cuenco de vidrio irrompible.



Anello portabicchieri per coppa jumbo

Cod. 509551_

28 Ø cm

34 Ø cm

40 Ø cm

Glass holding ring for jumbo bowl.

Anneau porte-verres pour coupe jumbo.

Ring 28 cm für 8 sektgläser.

Aro porta vasos para copa jumbo.

Coppa jumbo semisferica con base

Cod. 509555_

28 Ø cm

34 Ø cm

40 Ø cm

Jumbo bowl with foot.

Coupe jumbo semi-spherique avec base.

Champagner bowl.

Copa jumbo semiesférica con base.



Morsa prosciutto

58 cm h 17cm

Cod. 97200090

Ham clamp.

Porte jambon.

Schinkenspanner.

Porta jamón.



Sistema refrigerante rettangolare inox 18/10 corredato di gel pack

Cod. 509304_

40x30 4 h cm

50x35 4 h cm

60x40 4 h cm

Rectangular refrigerating system with double wall provided with refrigerating units.

Système réfrigérant rectangulaire double paroi avec réfrigérants.

Rechteckiges tablett mit kühlakku.

Sistema refrigerante rectangular doble pared con refrigerantes.

Gel pack

Cod. 97150169

20x19 cm

Refrigerating brick



Brocca termica inox 18/10

Cod. 557590_

1 Lt 15,8x24,5 h cm

1,5 Lt 15,8x26,5 h cm

2 Lt 15,8x29 h cm

Pitcher

Cruche

Krug

Lanzador

made in
Italy

A compact buffet station is shown with various food items. On the left, a basket of bread sits on a tray. In the center, a tray holds several types of cheese, including a wedge of hard cheese and a block of soft cheese. To the right, a tray contains several small glass bowls and a spoon. In the background, three bottles of beverages (one green, two red) are visible. The text 'PINNI buffet' is overlaid in a large, stylized font, with 'COMPACT' written below it in a smaller, bold font.

PINNI buffet

COMPACT



Porta tovaglioli
Napkin holder
Cod.51604300

Vassoio
multiuso con
separatori
removibili
*Multipurpose
tray with
removable
dividers*

Cod.51604600

Brocca
termica
Lt 1,5
*Thermic
jug*
Cod.55759015



Stazione
dolce/salato
*Bread, cheese
and salami
refrigerated
display*

Cod.51602400

Porta brocche/
ciotole
refrigerato multiuso
*Multipurpose
refrigerated
3-section
holder*

Cod.51600900

Supreme bowl
refrigerabile
multiuso con
copercchio
*Multipurpose
refrigerated
supreme bowl
with lid*

Cod.51606000



COMBINAZIONE
REFRIGERATA

OPTION
COOLED



COMBINAZIONE
MISTA

OPTION
NEUTRAL/COOLED



COMBINAZIONE
NEUTRA

OPTION
NEUTRAL



Pinti Buffet Compact

per Bed&Breakfast, Agriturismo, Garnì, Hotel e Boutique Hotel.

Salvaspazio, versatile ed elegante sono solo alcuni degli aggettivi per descrivere questa serie facilmente ambientabile e ideata per la prima colazione.

Tutti i materiali sono stati selezionati con estrema cura e una particolare attenzione ai molti utilizzi che i prodotti svolgono, con l'unico obiettivo di rendere la prima colazione il miglior modo per iniziare la giornata!

- Le basi e le strutture sono in legno nobilitato, antigraffio e resistente agli urti e alle macchie.
- Le cupole in PET sono eleganti nella forma, cristalline e impilabili, resistenti agli urti.
- Tutti i componenti in acciaio sono in aisi 304 (inox 18/10) certificato e idoneo al contatto alimentare, in conformità alle prescrizioni contenute nel D.M. 21/03/1973 pubblicato in G.U. n. 104 del 20/04/1973, nonché a quanto stabilito dal D.M. n. 108 del 25/01/1992 e dalla Direttiva CEE 89/109.
- Il vetro è temperato ed estremamente resistente agli urti e alle cadute accidentali.
- Le ciotole sono impilabili e dotate di coperchio trasparente secondo le norme igieniche vigenti. Eleganza e attenzione nei particolari, igiene e versatilità: ogni articolo può essere usato a temperatura ambiente oppure refrigerato con speciali mattonelle refrigeranti, per un ricco buffet pronto per ogni occasione.

Pinti Buffet Compact

perfect for Bed & Breakfast, Agriturismo, Garni, Hotels & Boutique Hotels.

Space-saving, versatile and stylish are just some of the adjectives to describe this line especially created for breakfast, that can easily fit in many different locations.

All materials have been selected with great care and particular attention to their resistance during the different uses that this multi-functional product can fulfill. Our aim is making breakfast the best way to start the day!

- The bases and frames are made of coated wood which are scratch-resistant, impact-resistant and stainproof.
- The PET cloches are elegantly transparent, stackable and resistant to the impact of daily use.
- All steel parts are made in AISI 304 steel (stainless steel 18/10) certified and suitable for food contact in accordance with the requirements contained in the MD 21/03/1973 posted in G.U. n. 104 of 20.04.1973, and as determined by the DM n. 108 of 01.25.1992 and by EEC Directive 89/109.
- The glass is tempered and extremely resistant to shocks and accidental falls.
- The glass bowls are stackable and come with a transparent lid in accordance with hygiene regulations.

Elegance and attention to detail, hygiene and versatility: each item can be used at ambient temperature or chilled with special gel packs. Compact is a complete buffet ready to be used in all contexts where you need to optimise the space available for breakfast.



Ogni prodotto è confezionato in scatola con fascetta personalizzata.

Each product is packed in a single box with sleeve.



Stazione dolce/salato refrigerabile

Cod. 51602400

EAN cod. 8007163213966

Bread, cheese and salami refrigerated display

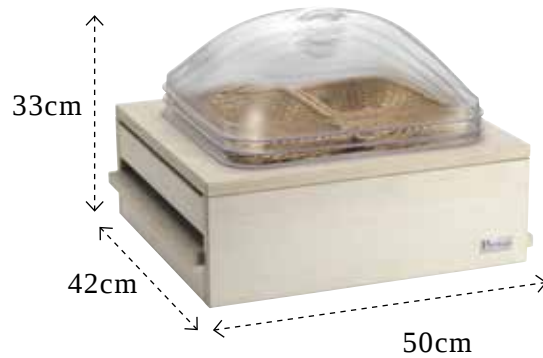

Composizione

Cod. 97150306
1 STRUTT. STAZIONE
DOLCE/SALATO
Coated wood base

Cod. 97150269
2 CESTE PANE
1/3 h 50
Bread baskets

Cod. 97150268
3 CUPOLE QUADRATE
Dome lids

Cod. 5BA12020
1 BACINELLA
GN 1/2 h 20
GN basin

Cod. 5BA12040
1 BACINELLA
GN 1/2 h 40
GN basin

Cod. 97150276
2 GEL PACK
cm 20x9,8
Refrigerating brick

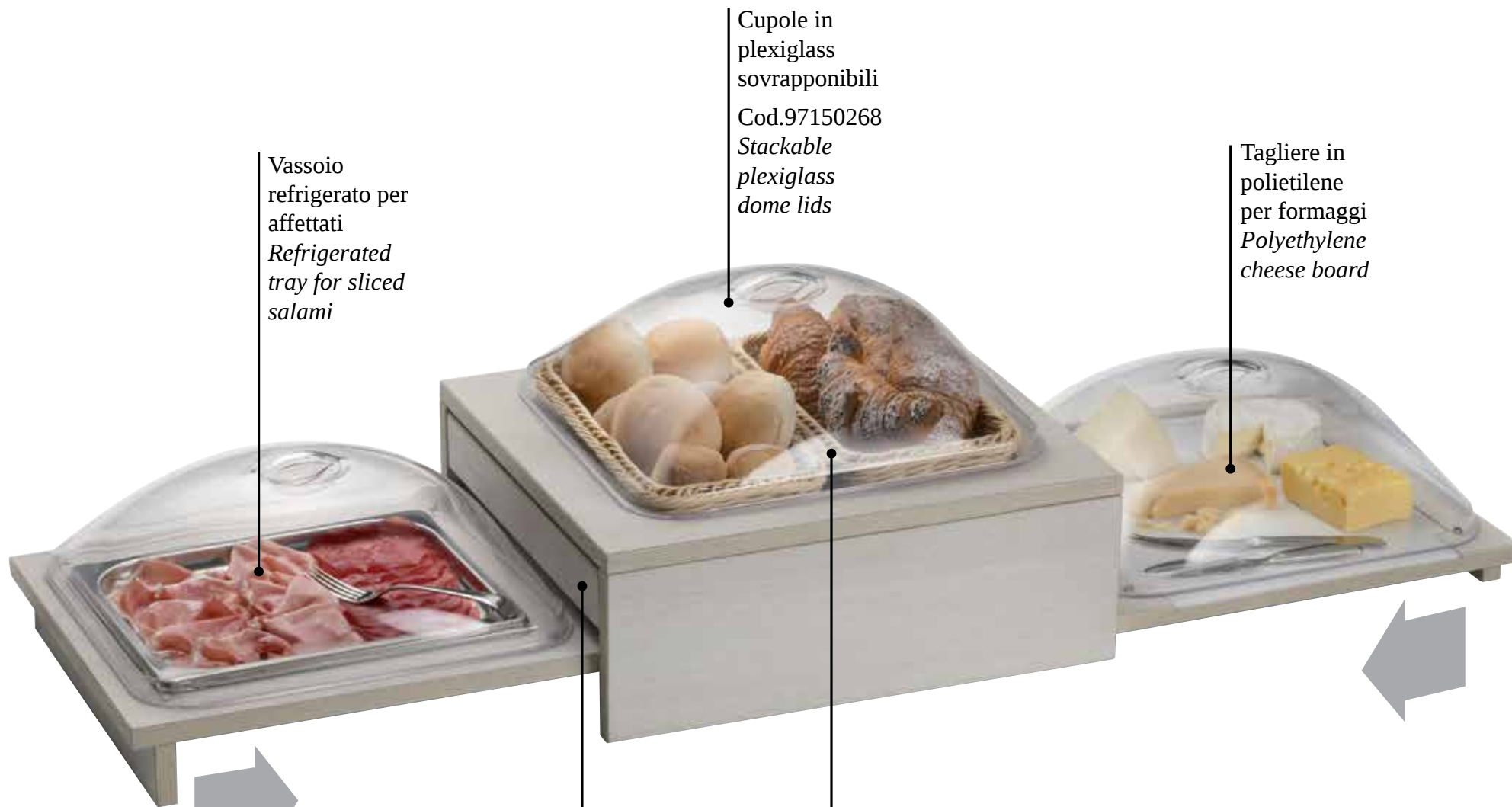

Vassoio refrigerato per affettati
Refrigerated tray for sliced salami

Cupole in plexiglass sovrapponibili
Stackable plexiglass dome lids
Cod.97150268

Tagliere in polietilene per formaggi
Polyethylene cheese board

Vassoio raccogli briciole estraibile
Portable crumb collecting tray

Ceste per pane e brioche
Brioche and bread basket
Cod.97150268



Pinti buffet
MADE IN ITALY



Supreme bowl refrigerabile multiuso con coperchio

Cod. 51606000

EAN cod. 8007163213997

Multipurpose refrigerated supreme bowl with lid

Composizione

- Cod. 97150302**
1 STRUTTURA
SUPREME BOWL
Coated wood base
- Cod. 97150303**
1 COPERCHIO APRIBILE
TRASP.
Ø cm 23
Openable lid
- Cod. 50951224**
1 COPERCHIO FORATO
Ø cm 24
Perforated lid

- Cod. 97200080**
1 CIOTOLA VETRO
INFRANG.
Ø cm 23 Lt 3
Glass bowl
- Cod. 50902322**
1 GRIGLIA
Ø cm 22
Grid
- Cod. 51607924**
1 CLOCHE SEMISFERICA
Ø cm 24
Semispheric cloche



1
PER
YOGURT
FOR
YOGURT



2
PER
MACEDONIA
FOR
FRUIT
SALAD



3
PER BURRO/
MARMELLATA
FOR JAM
& BUTTER



4
PER CONFEZ.
YOGURT
FOR YOGURT
PACKS



5
PER
FRUTTA
FOR FRUIT



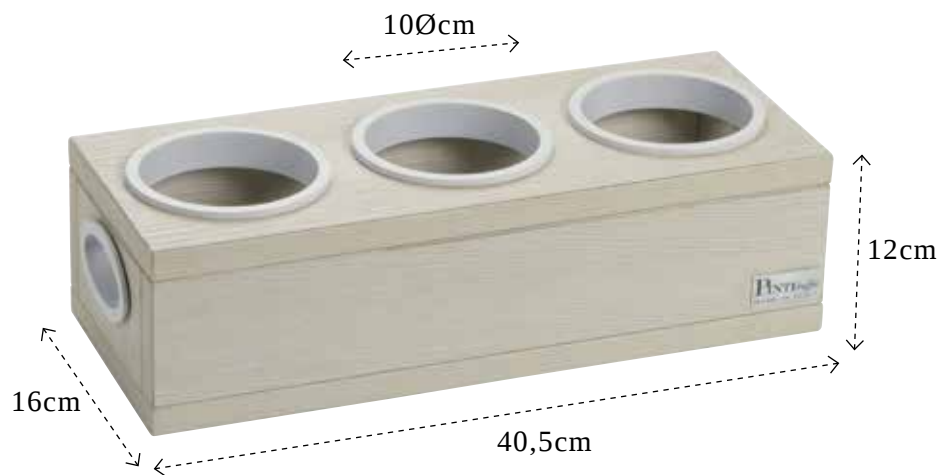

Porta brocche/ciotole refrigerato multiuso

Cod. 51600900

EAN cod. 8007163213959

Multipurpose refrigerated 3-section holder

Composizione

- Cod. 97150301**
1 STRUTTURA PORTA BROCCHIE/CIOTOLE
Coated wood base
- Cod. 97150305**
1 VASCHETTA TRASPARENTE
cm 36,9x12,4x2,4
Polypropylene basin
- Cod. 97150276**
2 GEL PACK
cm 20x9,8
Refrigerating brick



1

PER LATTE E CEREALI
FOR MILK & CEREALS



2

PER SUCCHI E BEVANDE REFRIGERATO
FOR JUICES & REFRIGERATED BEVERAGES



3

PER MARMELLATA REFRIGERATO
FOR JAM



4

VASSOIO/CONTENITORE HOLDER



5

ALZATA STAND

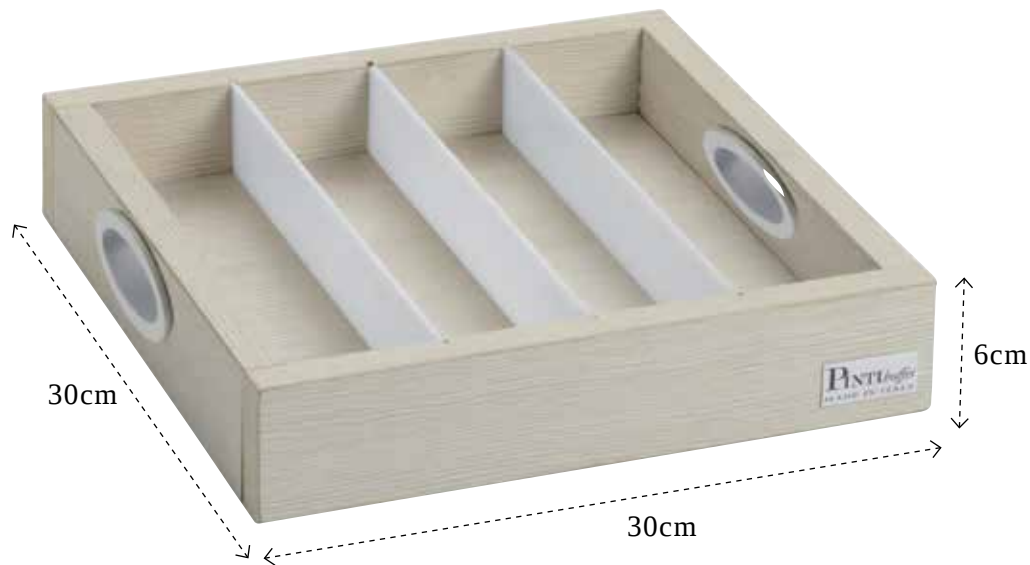

Vassoio multiuso con separatori removibili

Cod. 51604600

EAN cod. 8007163213980

*Multipurpose tray
with removable dividers*

1

PER CONFEZIONI
MONODOSE
FOR SINGLE
PACKS



2

PER BUSTINE
FOR TEABAGS
& SACHETS



3

PER
POSATE
FOR
CUTLERY





Porta tovaglioli

Cod. 51604300

EAN cod. 8007163213973

Napkin holder

Misura tovaglioli 16,5 cm

Napkin dimension 16,5 cm

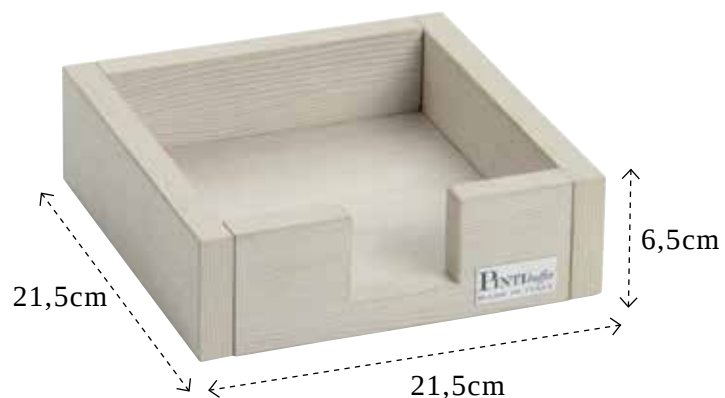

PINTI buffet
made in
Italy

Compact



Serie Astra

LA SERIE ASTRA ANTISCIVOLO BUFFET SI ADATTANO AD OGNI PORTATA!

THE ASTRA LINE ARE
SUITABLE FOR ANY COURSE!

La serie Astra s'è stata studiata appositamente per favorire l'uso del self-service. La speciale curvatura nella parte terminale della posata è autofrenante e ne impedisce lo scivolamento nei piatti e nei vassoi.

The Astra Line are specially designed for self-service. The special curve in the final part of the piece of cutlery is self-braking to prevent it from slipping into dishes and trays.

speciale curvatura • Special curve





Pala lasagne

cm 28

Cod. 07600080

*Spatula lasagna.
Pelle à lasagnes.
Lasagneheber.
Pala lasaña.*



Pala uovo

cm 28

Cod. 07600082

*Egg lifter.
Pelle à oeuf.
Eierheber.
Pala huevos.*



Pala torta

cm 30

Cod. 07600081

*Cake server.
Pelle à torte.
Tortenheber.
Pala pastel.*



Coltello servire

cm 32

Cod. 07600069

*Serving knife.
Couteau à servir
Serviermesser
Cuchillo servir.*



Forchetta
per vassoio
cm 20

Cod.07600033

*Serving fork.
Fourchette à servir.
Serviergabel.
Tenedor servir.*



Forchettone
servire
cm 24

Cod.07600088

*Serving fork.
Fourchette à servir.
Serviergabel.
Tenedor servir.*



Forchettone
insalata
cm 24

Cod.076000CF

*Salad fork.
Fourchette à salade.
Salatgabel.
Tenedor ensalada.*



Forchettone
insalata
cm 28

Cod.07600015

*Salad fork.
Fourchette à salade.
Salatgabel.
Tenedor ensalada.*



Forchettone
5 punte
cm 30

Cod.07600143

*5 prongs fork.
Fourchette à 5 dents.
Serviergabel 5 zinken.
Tenedor 5 púas.*



Forchettone
3 punte
cm 30

Cod.07600288

*3 prongs fork.
Fourchette à 3 dents.
Serviergabel 3 zinken.
Tenedor 3 púas.*



Cucch. marmellata

cm 19

Cod.076000CN

Jam spoon.

Cuiller confiture.

Marmelade Löffel.

Cuchara marmelada.



Cucchiaione

cm 20

Cod.07600040

Serving spoon.

Cuiller à servir.

Servierlöffel.

Cuchara servir.



Cucch. servire

cm 24

Cod.07600087

Serving spoon.

Cuiller à servir.

Servierlöffel.

Cuchara servir.



Cucch. forato

cm 24

Cod.07600287

Perforated spoon.

Cuiller perforée

Servierlöffel mit Löchern

Cuchara servir con agujeros.



Cucch. servire

cm 26

Cod.07600060

Serving spoon.

Cuiller à servir.

Servierlöffel.

Cuchara servir.



Cucch. forato

cm 26

Cod.07600260

Perforated spoon.

Cuiller perforée

Servierlöffel mit Löchern

Cuchara servir con agujeros.



Cucch. risotto

cm 28

Cod.07600280

Rice spoon.

Cuiller à "risotto".

Reislöffel.

Cuchara de arroz.



Cucch. pizzaiolo

cm 28

Cod.07600014

Tomato spoon.

Cuiller à tomates.

Pizza Löffel.

Cuchara para pizza.



Cucch. multiuso

cm 30

Cod.07600059

Serving spoon.

Cuiller à servir.

Servierlöffel.

Cuchara servir multiuso.



Cucch. forato

cm 30

Cod.07600259

Perforated spoon.

Cuiller perforée.

Servierlöffel mit Löchern

Cuchara servir con agujeros.



Molle

MOLLE PROFESSIONAL: di grandi dimensioni, per gastronomie e self-service.

MOLLE BUFFET: per il libero servizio.

MOLLE EASY LINE: ottimo rapporto qualità-prezzo, per l'utilizzo quotidiano.

PROFESSIONAL TONGS: big sizes for gastronomy and self-service use.

BUFFET TONGS: all uses and services.

EASY LINE TONGS: perfect for daily use, excellent value for money.

-Manico antiscivolo: la particolare forma del manico impedisce alle molle di scivolare all'interno del recipiente.

-Ergonomiche.

-Design funzionale: tutte le forme sono state studiate e progettate in base all'utilizzo dell'articolo.

-Packaging accattivante e dedicato.

-No-slip handle: the handle is designed to avoid slipping.

-Ergonomic.

-Functional Design: all the tongs are engineered and developed for a specific use.

-Nice and dedicated packaging.



**MOLLE
PROFESSIONAL
TONGS**

**MOLLE
BUFFET
TONGS**

**MOLLE
EASY LINE
TONGS**



PINTINOX
made in
Italy

Molle Tongs



Forbice dolce
Buffet

Cod.58130716 cm 16

Cod.58130720 cm 20

*Cake tongs
Pince a gâteau
Gebäckschere
Pinza para pastel*



Molla insalata
Buffet

cm 20

Cod.58136620

*Salad tong
Pince à salade
Salatzange
Pinza para ensalada*



Molla spaghetti
Buffet

cm 24

Cod.58136924

*Spaghetti tongs
Pince à spaghetti
Spaghetti-Zange
Pinza para espaguetis*



Molla arrosto
Buffet

cm 24

Cod.58136024

*Roast tongs
Pince à rôti
Bratenzange
Pinza para asado*



Molla multiuso
Buffet

cm 24

Cod.58137524

*Multi purpose tongs
Pince multi-usage
Allzweckzange
Pinza multiuso*



**Molla verdure
Buffet**

cm 24

Cod.58137424

*Vegetables tong
Pince à légumes
Gemüsezange
Pinza para vegetales*



**Molla universale
Buffet**

cm 24

Cod.58137324

*All purpose tongs
Pince universelle
Universalzange
Pinza universal*



**Molla dolce
Buffet**

cm 24

Cod.58136124

*Cake tongs
Pince à gâteau
Gebäckzange
Pinza para pastel*



**Molla servizio
Buffet**

cm 24

Cod.58137224

*Serving tongs
Pince de service
servierzange
Pinza servir*



**Molla pane
Buffet**

cm 24

Cod.58136824

*Bread tongs
Pince à pain
Brotzange
Pinza para pan*



Molla GN
Professional

cm 26

Cod.50919901

*Gastronorm tong
Pince gastronorm
Gastronormzange
Pinza gastronorm*



Molla spaghetti
Professional

cm 26

Cod.50919601

*Spaghetti tongs
Pince à spaghetti
Spaghetti-Zange
Pinza para espaguetis*



Molla arrosto
Professional

cm 26

Cod.50919701

*Roast tongs
Pince à rôti
Bratenzange
Pinza para asado*



Molla pane
Professional

cm 26

Cod.50919501

*Bread tongs
Pince à pain
Brotzange
Pinza para pan*



Molla insalata
Professional

cm 26

Cod.50919001

*Salad tong
Pince à salade
Salatzange
Pinza para ensalada*



Pinza del cuoco
Professional

Cod.58818330 cm 30

Cod.58818335 cm 35

Cod.58818340 cm 40

*Chef tong - Pince de chef
Chefzange - Pinza del
cocinero*



Molla
spaghetti

cm 20

Cod.50919600

*Spaghetti tongs
Pince à spaghetti
Spaghetti-Zange
Pinza para espaguetis*



Molla
dolce

cm 20

Cod.50919400

*Cake tongs
Pince à gâteau
Gebäckzange
Pinza para pastel*



Molla
arrosto

cm 21

Cod.50919700

*Roast tongs
Pince à rôti
Bratenzange
Pinza para asado*



Molla
pane

cm 22

Cod.50919500

*Bread tongs
Pince à pain
Brotzange
Pinza para pan*



Pinza
affettati

cm 10

Cod.50907100

*Sliced meat tongs
Pince à charcuterie
Aufschnittzange
Pinza para embutidos*



Molla
zucchero inox

cm 11

Cod.50919100

*Sugar tongs
Pince à sucre
Zuckerzange
Pinza para azucar*



Molla
ghiaccio

cm 13

Cod.50919200

*Ice tongs
Pince à glace
Eiszange
Pinza para hielo*

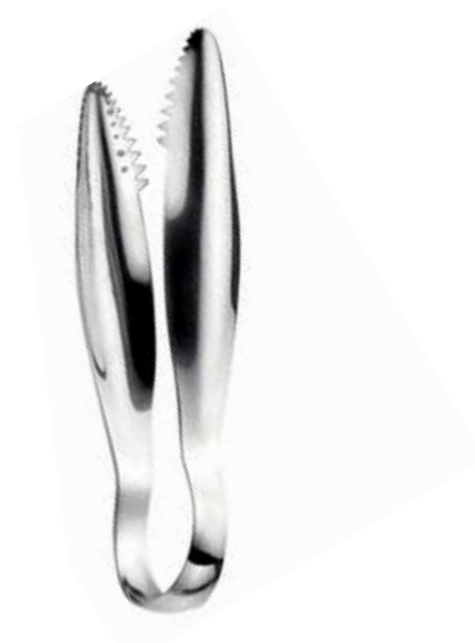

Molla
ghiaccio Elite

cm 15

Cod.50918900

*Ice tongs Elite
Pince à glace Elite
Eiszange Elite
Pinza para hielo*



IN
ESAURIMENTO
OUT OF STOCK

Molla ghiaccio
dentata inox 18/10

cm 16

Cod.50919300

*Ice tongs inox 18/10
Pince à glace inox 18/10
Eiszange mit Zähnen inox 18/10
Pinza para hielo inox 18/10*

Molla
lumache

cm 16

Cod.50919800

*Snails tongs
Pince à escargots
Schneckenzange
Pinza para caracoles*

Forbice
dolce

cm 20

Cod.50918000

*Cake tongs
Pince à gâteau
Gebäckschere
Pinza para pastel*

Pinza
del cuoco

cm 31,5

Cod.50918131

*Chef tong
Pince de chef
Chefzange
Pinza del cocinero*

Pinza del cuoco
punte piegate

Cod.78500440 cm 35

Cod.78500441 cm 45

*Chef tong
Pince de chef
Chefzange
Pinza del cocinero*

made in
Italy

PINNI buffet *trendybar*



PINTI *buffet* made in Italy *trendybar*



Caldi Heating

Espositore
con piastra
in ardesia
riscaldabile
con resistenza
elettrica

230 Volt 40 Watt

Cod. 51270200

cm 46x32x5,5h

Display with hot-plate.

PINTI *buffet* made in Italy *trendybar*



Neutri Neutral

Espositore
con vassoio
in porcellana

Cod. 51270201

cm 46x32x5,5h

*Display with
porcelain tray.*

Composizione

Cod. 97150179

1 VASSOIO PORCELLANA

cm 39x25x3,5

Porcelain tray



PINTI *buffet* made in Italy *trendybar*



Neutri Neutral

Espositore
4 ciotole
porcellana

Cod. 51270204

cm 46x32x5,5h

*Display with 4
porcelain bowls.*

Composizione

Cod. 97150172

2 CERAMICHE QUADRATE

cm 16x16x6

Square ceramics

Cod. 97150173

2 CERAMICHE RETTANGOLARI

cm 20x12,5x6

Rectangular ceramics

PINTI *buffet* made in Italy *trendybar*



Neutri Neutral

Espositore
7 ciotole
porcellana

Cod. 51270207

cm 46x32x5,5h
*Display with 7
porcelain bowls.*

Composizione

Cod. 97150170

3 CERAMICHE QUADRATE
cm 8x8x4

Rectangular ceramics

Cod. 97150171

2 CERAMICHE QUADRATE
cm 13x13x4,5

Rectangular ceramics

Cod. 97150173

2 CERAMICHE RETTANGOLARI
cm 20x12,5x6

Rectangular ceramics



PINTI *buffet* made in Italy *trendybar*



Neutri Neutral

Espositore
12 ciotole
porcellana

Cod. 51270212

cm 46x32x5,5h
*Display with 12
porcelain bowls.*

Composizione

Cod. 97150170

12 CERAMICHE QUADRATE
cm 8x8x4
Square ceramics

PINTI buffet

made in Italy
trendybar



Neutri Neutral

Espositore
7 ciotole
porcellana

Cod. 512702A7

cm 46x32x5,5h
*Display with 7
porcelain bowls.*

Composizione

Cod. 97150170

4 CERAMICHE QUADRATE
cm 8x8x4
Square ceramics

Cod. 97150173

3 CERAMICHE RETTANGOLARI
cm 20x12,5x6
Rectangular ceramics



PINTI *buffet* made in Italy *trendybar*



Neutri Neutral

Alzata 3 piani
6 ciotole
porcellana

Cod. 51271006

cm 25x20x29h

3 livels fixed stand with 6
porcelain bowls.

Composizione

Cod. 97150170

6 CERAMICHE QUADRATE
cm 8x8x4

Square ceramics

PINTI *buffet*
made in
Italy
trendybar



Neutri
Neutral

Champagnera

4 bottiglie

Cod. 51272604

cm 46x32x19,5h

Champagne
refrigerated holder
for 4 bottles.



PINTI *buffet*
made in
Italy
trendybar



Neutri
Neutral
Champagnera
8 bottiglie
Cod. 51272608

cm 59x38x19,5h
Champagne
refrigerated holder
for 8 bottles.

PINTI *buffet*
made in
Italy
trendybar



Neutri
Neutral

Espositore
bustine

Cod. 51270700

cm 25x20x29h

Sugar display.





PINTI *buffet*
made in
Italy
trendybar



Neutri
Neutral

Porta
bustine
servire

Cod. 51274400

cm 20x9,5x4,5h

Serving sugar/tea
display.

PINTI *buffet*
made in
Italy
trendybar



Neutri
Neutral

Porta
tovaglioli
piano

Cod. 51274300

cm 20x20x5,5h

Napkin holder.



PINTI *buffet*
made in
Italy
trendybar



Neutri
Neutral

ECOntainer

Cod. 51274800

Ø cm 14x15h

ECOntainer.

PINTI *buffet* made in Italy *trendybar*



Neutri Neutral

Vassoio
aperitivo

Cod. 51274700

cm 24x31x16,5h

Tray.

Composizione

Cod. 97150170

2 CERAMICHE QUADRATE
cm 8x8x4

Square ceramics

Cod. 97150171

2 CERAMICHE QUADRATE
cm 13x13x4,5

Square ceramics



PINTI *buffet* made in Italy *trendybar*



Neutri Neutral

Portaposate
Happy Hour

Cod. 51273900

cm 31x7x10h

Happy Hour
cutlery holder.

Composizione

Cod. 97150178

5 BICCHIERI PORCELLANA

Ø cm 4

Porcelain bowl



Master
120 pezzi
Happy Hour

Cod.0620MKU_

*Master 120 pcs
Présentation 120 pcs
Master 120-teilig
Master 120 piezas*

*design
Daniele Ardissonne*



Tridente

Trident - Trident
Dreizack - Tridente
cm. 10

Cod. 0620N6UE
SC. REGALO 6 PZ.
6 pcs. in gift box.
Boîte cadeau 6 pcs.
Geschenkschachtel
6-teilig.
Caja regalo 6 piezas.

Cod. 0620MKUE
MASTER 120 PZ.
Master 120 pcs.
Présentation 120 pcs.
Master 120-teilig.
Master 120 piezas.



Spillo

Pin - Epingle
Lanze - Aguja
cm. 10

Cod. 0620N6UT
SC. REGALO 6 PZ.
6 pcs. in gift box.
Boîte cadeau 6 pcs.
Geschenkschachtel
6-teilig.
Caja regalo 6 piezas.

Cod. 0620MKUT
MASTER 120 PZ.
Master 120 pcs.
Présentation 120 pcs.
Master 120-teilig.
Master 120 piezas.



Lama

Blade - Lame
Klinge - Cuchilla
cm. 10

Cod. 0620N6UJ
SC. REGALO 6 PZ.
6 pcs. in gift box.
Boîte cadeau 6 pcs.
Geschenkschachtel
6-teilig.
Caja regalo 6 piezas.

Cod. 0620MKUJ
MASTER 120 PZ.
Master 120 pcs.
Présentation 120 pcs.
Master 120-teilig.
Master 120 piezas.



Jolly

Joker - Joker
Jolly - Jolly
cm. 10

Cod. 0620N6UP
SC. REGALO 6 PZ.
6 pcs. in gift box.
Boîte cadeau 6 pcs.
Geschenkschachtel
6-teilig.
Caja regalo 6 piezas.

Cod. 0620MKUP
MASTER 120 PZ.
Master 120 pcs.
Présentation 120 pcs.
Master 120-teilig.
Master 120 piezas.



Cucchiaio

Paddle - Cuiller
Löffel - Cuchara
cm. 10

Cod. 0620N6UL
SC. REGALO 6 PZ.
6 pcs. in gift box.
Boîte cadeau 6 pcs.
Geschenkschachtel
6-teilig.
Caja regalo 6 piezas.

Cod. 0620MKUL
MASTER 120 PZ.
Master 120 pcs.
Présentation 120 pcs.
Master 120-teilig.
Master 120 piezas.



Mixer

Mixer - Mélangeur
Mixer - Mixer
cm. 10

Cod. 0620N6UQ
SC. REGALO 6 PZ.
6 pcs. in gift box.
Boîte cadeau 6 pcs.
Geschenkschachtel
6-teilig.
Caja regalo 6 piezas.

Cod. 0620MKUQ
MASTER 120 PZ.
Master 120 pcs.
Présentation 120 pcs.
Master 120-teilig.
Master 120 piezas.

PINTI *buffet* made in Italy *trendybar*



Freddi

Refrigerating systems

Espositore
refrigerato
3 ciotole
porcellana

Cod. 512703A3

cm 38x32x5,5hh

Refrigerated display with
3 porcelain bowls.

Composizione

Cod. 97150170

2 CERAMICHE QUADRATE

cm 8x8x4

Square ceramics

Cod. 97150172

1 CERAMICA QUADRATA

cm 16x16x6

Square ceramics



Note Informative: vedi pag. / Technical information: see page / Notes d'information: voir page / Hinweise teile: Siehe Seite / Notas informativas: ver pagina 180
Acciaio Inossidabile 18/10 & MDF / Stainless steel 18/10 & MDF / Acier 18/10 & MDF / Edelstahl 18/10 & MDF / Acero 18/10 & MDF

PINTI *buffet* made in Italy *trendybar*



Freddi Refrigerating systems

Espositore
refrigerato
2 ciotole
porcellana

Cod. 51270302

cm 38x32x5,5hh

Refrigerated display with
2 porcelain bowls.

Composizione

Cod. 97150173

2 CERAMICHE RETTANGOLARE

cm 20x12,5x6

Rectangular ceramics

PINTI *buffet* made in Italy *trendybar*



Freddi

Refrigerating systems

Espositore
refrigerato
3 ciotole
porcellana

Cod. 51270303

cm 38x32x5,5hh

Refrigerated display with
3 porcelain bowls.

Composizione

Cod. 97150171

2 CERAMICHE QUADRATE
cm 13x13x4,5
Square ceramics

Cod. 97150173

1 CERAMICA RETTANGOLARE
cm 20x12,5x6
Rectangular ceramics



Note Informative: vedi pag. / Technical information: see page / Notes d'information: voir page / Hinweise teile: Siehe Seite / Notas informativas: ver pagina 180
Acciaio Inossidabile 18/10 & MDF / Stainless steel 18/10 & MDF / Acier 18/10 & MDF / Edelstahl 18/10 & MDF / Acero 18/10 & MDF

PINTI *buffet* made in Italy *trendybar*



Freddi Refrigerating systems

Espositore
5 ciotole
porcellana

Cod. 51270305

cm 38x32x5,5h

*Refrigerated display with
5 porcelain bowls.*

Composizione

Cod. 97150170

3 CERAMICHE QUADRATE
cm 8x8x4

Square ceramics

Cod. 97150171

2 CERAMICHE QUADRATE
cm 13x13x4,5

Square ceramics

PINTI buffet
made in Italy
trendybar



Freddi
Refrigerating systems

Espositore
refrigerato
6 ciotole
porcellana

Cod. 51270306

cm 38x32x5,5h

Refrigerated display with
6 porcelain bowls.

Composizione

Cod. 97150170

6 CERAMICHE QUADRATE
cm 8x8x4
Square ceramics





Componenti

Components

Struttura base alta
in mdf bianco
cm 64x46x21
Cod.9715B752
White mdf base high



Struttura base alta
in mdf wenge
cm 64x46x21
Cod.97150752
Wenge mdf base high



Struttura carrello
servire caldo in mdf
cm 102x45x88
Cod.97150741
Euro 504,58
Mdf hot food serving trolley

Abbinabili con:
Can be used with:



Chiusura a frizione
Friction closing
Composizione:

Cod. 97150071 2 pcs Euro 10,50 cad.
Cod. 97150023 1 pcs
Cod. 97150024 1 pcs



Cod.F11B5555 Chafing dish GN 1/1 c/chiusura a frizione
GN rectangular chafing dish 1/1



Cod. F11B2810 Porta verdure riscaldato c/chiusura a frizione
4 complete heating basin for vegetables



Cod.50950930 Porta brioches riscaldato
Rectangular heating tray with cover for brioche



Cod.F1135556 Zuppiera due stazioni riscaldata
2 heated soup bowls



Struttura base
bassa in
mdf bianca
cm 64x46x12
Cod.9715B751
White mdf base low



Struttura base
bassa in
mdf wenge
cm 64x46x12
Cod.97150751
Wenge mdf base low

Abbinabili con:
Can be used with:



Cod.F1136900 Cesta pane con vassoio

Bread basket with cover with tray



Cod.F11F3100 Vassoio porta burro/marmellata

Refrigerated tray for jam and butter



Cod.F1131A00 porta brocche refrigerato

Refrigeret wall pieces jug holder



Cod.F11F2600 Porta champagne

Champagne holder



Cod.F1132820 Porta verdure refrigerato

Refrigeret basin for vegetables



Cod.F1132830 Porta uovo/verdura refrigerato

Double refrigerated trays for eggs and vegetables

Cod.F1132840 Porta yogurt/verdura refrigerato

Rectangular basin with cover for youghurt and vegetables



Cod.F1133700 Porta bottiglie refrigerato

Refrigeret bottles holder



Cod.F1133900 Porta posate

Cutlery containers



Cod.F1132900 Porta yougurt forato

Refrigeret tray with holes for yogurth

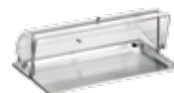

Cod.50950950 Vassoio per affettati

Refrigerated tray with cover for sliced salami

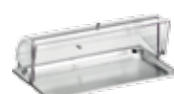

Cod.50950920 Vassoio pasticceria

Rectangular tray with cover for pastries



Cod.50950940 Vassoio per formaggi

Board with cover for cheese



Cod.97150755 Vassoio porta porcellane

Chinaware holder

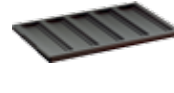

Cod.F1136800 Tagliere pane con vassoio

Bread board with tray

Struttura alzata
doppia in mdf bianco
cm 59x46x29
Cod. 9715B754
*White mdf double
deck trays*



Struttura alzata
doppia in mdf wenge
cm 59x46x29
Cod. 97150754
*Wenge mdf double
deck trays*

Abbinabili con:
Can be used with:



Cod.F1136900 Cesta pane con vassoio

Bread basket with cover with tray

Cod.F11F3100 Vassoio porta burro/marmellata

Refrigerated tray for jam and butter

Cod.F1132900 Porta yogurt forato

Refrigeret tray with holes for yogurth

Cod.50950950 Vassoio per affettati

Refrigerated tray with cover for sliced salami



Cod.50950920 Vassoio pasticceria

Rectangular tray with cover for pastries

Cod.50950940 Vassoio per formaggi

Board with cover for cheese

Cod.F1136800 Tagliere pane con vassoio

Bread board with tray

Struttura carrello
doppio vari
utilizzi in mdf
cm 87x55x88
Cod. 97150742
*Mdf food serving
trolley double spaces
for many uses*



Abbinabili con:
Can be used with:



Cod.F1136900 Cesta pane con vassoio

Bread basket with cover with tray



Cod.F11F3100 Vassoio porta burro/marmellata

Refrigerated tray for jam and butter



Cod.F11F2600 Porta champagne

Champagne holder



Cod.F1132820 Porta verdure refrigerato

Refrigeret basin for vegetables



Cod.F1132830 Porta uovo/verdura refrigerato

Double refrigerated trays for eggs and vegetables



Cod.F1133900 Porta posate

Cutlery containers



Cod.F1132900 Porta yougurt forato

Refrigeret tray with holes for yogurth



Cod.50950950 Vassoio per affettati

Refrigerated tray with cover for sliced salami



Cod.50950920 Vassoio pasticceria

Rectangular tray with cover for pastries



Cod.50950940 Vassoio per formaggi

Board with cover for cheese

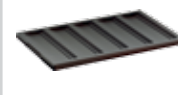

Cod.97150755 Vassoio porta porcellane

Chinaware holder



Cod.F1136800 Tagliere pane con vassoio

Bread board with tray

Cod. 97150764 Cesta pane rotonda wenge c/forcella con cupola
Wenge bread basket with hooks with cover

cm 48x38,5



Cod. 97150765 Cesta pane rotonda wenge
Wenge bread basket

cm 48x13,5



Cod. 97150759 Cesta pane rettangolare wenge c/forcella con cupola
Wenge rectangular bread basket with hooks with cover

cm 52,5x32x29,5



Cod. 97150760 Cesta pane rettangolare pail c/forcella con cupola
Rectangular bread basket with hooks with cover

cm 52,5x32x29,5



Cod. 97150762 Cesta pane rotonda pail c/forcella con cupola
Bread basket with hooks with cover

cm. 48x38,5



Cod. 97150761 Cesta pane rettangolare pail
Rectangular bread basket

cm 52,5x32x12



Cod. 97150763 Cesta pane rotonda pail
Bread basket

cm 48x13,5





Cod. 9715M170 Porcellana bianca quadrata
White square porcelain
master 12 pz.-pcs.

cm 8x8x4



Cod. 9715M171 Porcellana bianca quadrata
White square porcelain
master 6 pz.-pcs.

cm 13x13x4,5



Cod. 9715M172 Porcellana bianca quadrata
White square porcelain
master 6 pz.-pcs.

cm 16x16x6



Cod. 9715M173 Porcellana bianca rettangolare
White rectangular porcelain
master 6 pz.-pcs.

cm 20x12,5x6



Cod. 9715M179 Vassoio porcellana
Porcelain tray
master 4 pz.-pcs.

cm 39x25x3,5



Cod. 9715M178 Bicchiere porcellana
Porcelain bowl
master 9 pz.-pcs.

Ø cm 4

Cod. 97150785 Bacinella porcellana 1/1

China basin 1/1

Made in Italy 

h 65 cm



Cod. 97150786 Bacinella porcellana 2/3

China basin 2/3

Made in Italy 

h 65 cm



Cod. 97150787 Bacinella porcellana 1/2

China basin 1/2

Made in Italy 

h 65 cm



Cod. 97150788 Bacinella porcellana 1/3

China basin 1/3

Made in Italy 

h 65 cm



Cod. 97200096 Brocca vetro buffet

Buffet glass jug

lt.1,5



Cod. 57010800 Porta tovaglioli verticale

napkin holder



Cod. 57010900 Porta tovaglioli orizzontale

Napkin holder





Cod. 97150782 Cupola in plexiglass per bacinella GN 2/3
Dome lid for stand

cm 36x40x15



Cod. 97150111 Cupola tonda PC
Dome lid

Ø cm 47,5



Cod. 97150112 Cupola rettangolare PC
Rectangular dome lid

cm 51,5x33x18



Cod. 97150164 Tagliere pane in legno
Wood bread board

cm 49,5x28,5



Cod. 97150174 Tagliere in polietilene colore nero
Polyethylene board

cm 50x30x2,3



Cod. 51134900 Vassoio nero antiscivolo porta bicchieri in ABS
ABS non slip trays

cm 53,5x33

Cod. 97200078 Fornelletto inox
Stainless steel burner holder



Cod. 97200089 Supporto per fornello inox
Holder for stainless steel burner holder



Cod. 97150119* Resistenza con selettore per distrib. bevande calde
Heater with adjuster for hot drink dispenser
IN ESAURIMENTO - OUT OF STOCK

230 V 240 W



Cod. 97150245* Resistenza con selettore per distrib. bevande calde
Heater with adjuster for hot drink dispenser
IN ESAURIMENTO - OUT OF STOCK

230 V 240 W



Cod. 97150118* Resistenza con regolatore per chafing dish
Heater with adjuster for chafing dish

230 V 700 W



Cod. 97150770* Resistenza per vassoio brioches
Heater for rectangular heating tray for brioche

230 V 40 W





Cod. 97150276 Gel Pack

Refrigerating brick

cm. 20x9,8



Cod. 97150038 Contenitore Ø cm 16 s/coperchio con colonna refrigerante e c/rubinetto Tomlinson

Cod. 97150039 Contenitore Ø cm 20 s/coperchio con colonna refrigerante e c/rubinetto Tomlinson

Dispenser tank without lid with refrigerating pipe for ice cubes faucet



Cod. 97150052 Distributore cereali c/coperchio

Cereal dispenser with lid

Ø cm 18



Cod. 97150221 Rubinetto completo Tomlinson con rondella elastica

Tomlinson faucet



Cod. 97150280 Boccettino vernice bianco lucido

Bright White varnish bottle



Cod. 97150281 Boccettino vernice wenge

Wenge varnish bottle

Cod.55759010 Brocca termica Lt 1

Thermic jug Lt 1

Cod.55759015 Brocca termica Lt 1,5

Thermic jug Lt 1,5

Cod.55759020 Brocca termica Lt 2

Thermic jug Lt 2



Cod.90230815 Targhetta "Latte-Caffè" per brocca

Plate "Milk-Coffee" for jug

Ø cm 6,5

Cod.90230810 Targhetta "Latte-Acqua Calda" per brocca

Plate "Milk-Hot Water" for jug

Ø cm 6,5



Cod.97200115 Brocca in vetro con tappo in sughero

Glass jug with lid

Lt 1



Cod.97200116 Set 3 ciotole in vetro

Glass bowl 3-piece set

Ø cm 10,5



Cod.97200117 Set 3 coperchi trasparenti con pomolo per ciotole

Glass bowl 3-piece set

Ø cm 10,5



Cod.97150309 Tagliere per stazione dolce/salato

Cooking board for bread, cheese and salami display

cm 38x30



Cod.97150305 Vaschetta per porta brocche/ciotole refrigerato multiuso

Basin for multipurpose refrigerated 3-section holder

cm 36,9x12,4x2,4 h





Cod.97150268 Cupola quadrata sovrapponibile
Dome lid

cm 35x38x13 h



Cod.97200080 Ciotola in vetro per supreme bowl multiuso
Glass bowl for supreme bowl

Ø cm 23



Cod.50902322 Griglia per supreme bowl multiuso
Grid for supreme bowl

Ø cm 22



Cod.97150303 Coperchio apribile trasparente con cerniera e pomolo per supreme bowl
Polycarbonate lid

Ø cm 23



Cod.50951224 Coperchio forato per supreme bowl
Perforated lid for supreme bowl

Ø cm 24



Cod.51607924 Cloche semisferica per supreme bowl
Semispheric cloche for supreme bowl

Ø cm 24

Cod. 9715B810 Base bianca c/aste per portaciotole 24 pz
White stand – 24 glasses

cm 30x15x36



Cod. 9715B811 Base bianca c/aste per portaciotole 36 pz
White stand – 36 glasses

cm 19x10x26



Cod. 97150810 Base wenge c/aste per portaciotole 24 pz
Wenge stand – 24 glasses

cm 30x15x36



Cod. 97150811 Base wenge c/aste per portaciotole 36 pz
Wenge stand – 36 glasses

cm 19x10x26



Cod. 97200099 Ciotola in vetro
Bowl

Ø cm 12



Cod. 97200098 Ciotola in vetro
Bowl

Ø cm 6



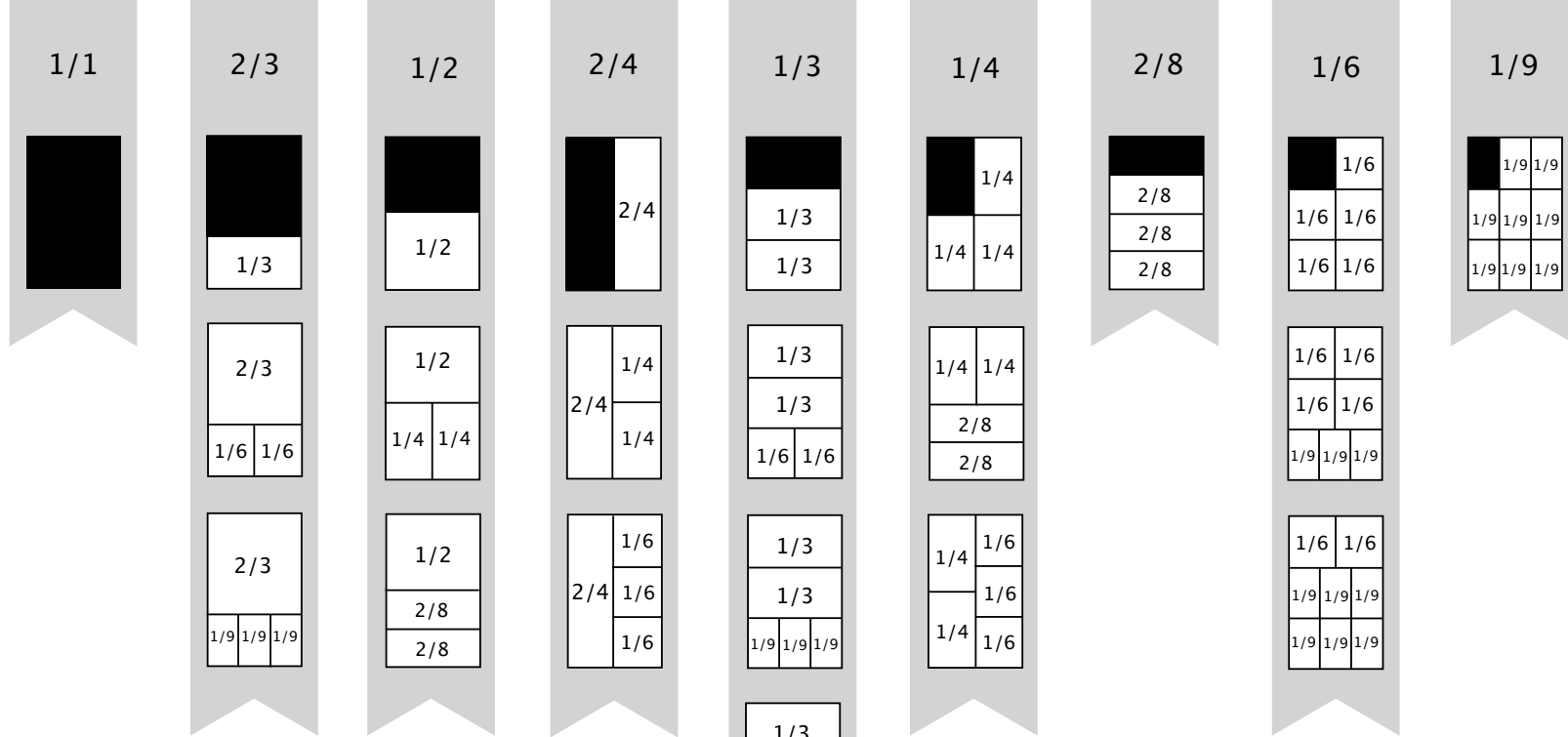

Acciaio e Spessori

La serie Gastronorm è prodotta con acciaio AISI 304, chiamato anche 18/10, negli spessori:

- 1 mm per i modelli 2/1
- 0,7 e 0,8 per le altre pezzature restanti

Lucidatura

Le altezze 100, 150, 200 sono sottoposte ad una operazione di normalizzazione termica e poi lucidate mediante burattatura. Oggetti di grandi dimensioni sono puliti per via elettrolitica. Le altezze 65, 40 e 20 e sottoposte a trattamento chimico che permette di ottenere una lucidatura omogenea su tutta la superficie.

Confezione

Ogni singolo pezzo è sottoposto a lavaggio speculare ad alta temperatura 90° e confezionato in polipropilene pronto per l'uso già sterilizzato.

Capacità

I raggi ridotti al min. offrono il max della capienza nel minimo ingombro.

Materiali

Sono tutti certificati ed idonei al contatto con gli alimenti ai sensi dell' DM. 25-1-1992 art. 4-5° comma D.L. 208 e DIR. CEE 89/109.

Lavaggio

Resistenti all'uso prolungato in lavastoviglie.

Misure

In accordo con gli standard internazionali della CEE doc. CEN/TC 194 EN631-1.

The Steel and the Thicknesses

The Gastronorm range is made of AISI 304 steel also called 18/10, in the following thicknesses:

- 1 mm for the 2/1 models
- 0,7 and 0,8 for the remaining sizes

Polishing

Heights 100, 150 and 200 are thermally normalised and then polished by tumbling. Large items are etch cleaned. Heights 65, 40 and 20 and are subjected to a chemical treatment permitting the attainment of even polishing over the entire surface.

Packaging

Each individual piece is bright washed at the high temperature of 90° and packaged in polypropylene, ready for use already sterilised.

Capacity

The finely rounded bottom edges offer maximum capacity in the minimum space.

Materials

All the materials are certified to be suitable for contact with foodstuffs according to DM. 25-1-1992 art. 4 - 5th para. D.L. 208 and EEC Directive 89/109.

Washing

Resistant to prolonged dish-washing.

Sizes

In accordance with the international EEC standards doc. CEN/TC 194 EN631-1.



Note informative sui componenti

Acciaio Inox 18/10

L'acciaio Inox 18/10 - Aisi 304 viene fornito esclusivamente dalle principali acciaierie europee.

La sua eccezionale resistenza alla ruggine, la brillantezza e le caratteristiche igieniche soddisfano i requisiti della moderna gastronomia. Esso infatti resiste agli acidi contenuti nei prodotti alimentari, nei detersivi.

L'acciaio Inox 18/10 è antiurto e particolarmente adatto al lavaggio in lavastoviglie.

Polycarbonato. PC

Il polycarbonato è un polimero di pregio che racchiude alcune caratteristiche della plastica, dell'acciaio e del vetro.

La trasparenza si avvicina al 90%. La resistenza meccanica alla deformazione ha un'elevata resistenza all'urto.

L'elevata stabilità dimensionale viene garantita fino ad una temperatura di 130 gradi. In presenza di fiamma è autoestinguento.

Avvertenze. Non resiste a: soluzioni alcaline, acetone, ammoniaca, benzolo ed alcool metilico.

Il materiale è sicuro dal punto di vista fisiologico e può andare a contatto con gli alimenti.

Componenti in MDF e in Legno

Il MDF (Medium Density Fibreboard, pannello di fibra a media densità) è un derivato del legno: è il più famoso e diffuso della famiglia dei pannelli di fibra.

I caldi e i distributori sono realizzati in mdf speciale ignifugo. Avvertenze. Per mantenere a lungo la qualità del prodotto è necessario:

- Non immergere in liquidi o acqua
- Pulire con panno umido d'acqua
- Evitare l'utilizzo di sostanze abrasive
- Tenere lontano da fiamme libere o fonti di calore
- Evitare l'esposizione prolungata al sole, per evitare variazione di colore e deformazioni.

NB Il legno essendo un prodotto naturale può assumere tolleranze diverse a seconda della temperatura e dell'umidità presente nell'ambiente circostante.

Sono possibili eventuali gradazioni di colore e venature in quanto prodotto in legno naturale.

Il tagliere in Legno Faggio naturale è garantito a norma di legge, è trattato per non assorbire odori e ritenere umidità.

Deve essere lavato a mano e asciugato.

Polipropilene

Il polipropilene è ad alta resistenza e garantito per alimenti.

Resistenze

Sono adatte a un voltaggio di 220 Volts e dotate di spina schuko. Conformi alle leggi CEE. Per distributore bevande calde o chafing dish non utilizzare con contenitori vuoti. Per il corretto utilizzo e per la manutenzione fare comunque riferimento alle note presenti all'interno della confezione.



Technical information on components

18/10 AISI 304 stainless steel

18/10 AISI 304 stainless steel is supplied almost exclusively by the main European steelworks. Its exceptional rust resistance, its brilliance and hygienic qualities satisfy the requirements of modern gastronomy; in fact, it resists to the acids contained in foodstuffs, detergents and is shockproof. 18/10 steel is dishwasher safe.

Polycarbonate. PC

Polycarbonate is a valuable polymer that has some characteristics from plastics, steel and glass. Its transparency is close to 90%. Its strain strength has a high impact strength. Its high dimensional stability is guaranteed up to a 130-degree temperature. In the presence of flame, it is self-extinguishing. Both i Caldi and the Dispenser are made in special fireproof MDF.

Warning: it does not withstand: alkaline solutions, acetone, ammonia, benzol and methyl alcohol.

The material is safe from the physiological point of view and can get in touch with food.

MDF and Wood Components

MDF (Medium Density Fibreboard) is a wood derivative as well as the most famous and widespread of fibre panels.

Warning. To guarantee the quality of the product in the time:

- Do not plunge in liquids or in water
- Clean with a water-dampened cloth
- Do not use abrasive agents or solvents
- Keep away from flames or heat sources
- Do not expose to the sun for a long-time to avoid colour changes and deformations.

N.B. Wood is a natural product and can have different tolerances according to the environment temperature and humidity.

This product made of natural wood may have different colour nuances and veins China is suitable for food usage and does not contain harmful substances or release dangerous elements.

The Beech wood board is guaranteed by law and is treated not to absorb smells and humidity. It must be hand washed and dried with care.

Polypropylene

Polypropylene is highly resistant and suitable for foodstuff. Resistances

The electric resistance is suitable for 220 W voltage and are provided with schuko plug. In compliance with CEE norm. For hot drink dispenser and chafing dish. Do not use with empty drink dispenser and chafing dish. For a correct use please refer to the instructions leaflet inside the box.



Notes d'information sur les composants

Acier Inox 18/10 AISI 304

Notre acier inox 18/10 AISI 304 est fourni presque exclusivement par les principales aciéries européennes.

Sa résistance exceptionnelle à l'oxydation, sa brillance et ses caractéristiques hygiéniques satisfont les exigences de la gastronomie moderne; il résiste aux chocs et aux acides contenus dans les aliments et dans les détergents.

L'acier 18/10 est spécialement indiqué pour le lavage au lave-vaisselle.

Polycarbonate. PC

Le polycarbonate est un polymère de haute qualité réunissant quelques-unes des caractéristiques du plastique, de l'acier et du verre. Sa transparence est proche de 90%.

Sa résistance mécanique à la déformation assure une résistance élevée aux chocs. Sa haute stabilité dimensionnelle est garantie jusqu'à une température de 130 degrés. En présence de flamme, il est autoextinguible.

Avvertissements. Ne résiste pas à : solutions alcalines, acétone, ammoniac, benzol et alcool méthylique.

Le matériel est sûr du point de vue physiologique et apte au contact avec les aliments.

Composants en MDF et en Bois

Le MDF (Medium Density Fibreboard, ou panneau en fibre moyenne densité) est un dérivé du bois : est le plus fameux et le plus répandu de la famille des panneaux de fibres.

Les pièces de buffet réchauffées et tous les distributeurs à boissons sont en MDF ignifuge.

Avvertissements. Pour conserver longtemps la qualité du produit, respecter les indications suivantes :

- Ne pas plonger dans des liquides ou dans l'eau
- Nettoyer avec un chiffon humidifié avec de l'eau
- Éviter l'utilisation de substances abrasives ou de solvants

- Tenir éloigné des flammes libres ou des sources de chaleur
- Éviter l'exposition prolongée au soleil pour éviter les variations de couleur et les déformations.

N.B. Le bois est un matériau naturel et peut être altéré par la chaleur ou par l'humidité ambiante. Ces produits en bois naturel peuvent présenter des variations de couleur et des veines différentes. La planche à découper en hêtre naturel est à norme de loi, traitées pour ne pas absorber d'odeurs et pour retenir l'humidité. Elles doivent être lavées à la main et séchées.

Polypropylène

Le polypropylène est un matériel avec une résistance élevée et il est garanti pour le contact alimentaire.

Résistances

Elles sont adaptées à une tension de 220 volts et avec prise schuko. Conforme aux normes cee. Pour distributeur boissons chaudes et chafing dish. Ne pas utiliser avec distributeur boisson chaudes et chafing dish vides. Pour une utilisation correcte merci de lire le mode d'emploi dans la boîte.



Hinweise über die teile

Edelstahl 18/10 AISI 304

AISI 304 wird in erster Linie von europäischen Stahlwerken geliefert.

Seine außergewöhnliche Rostbeständigkeit, der Glanz und die Hygienemerkmale erfüllen die Anforderungen der modernen Gastronomie und ist stoßbeständig.

Edelstahl 18/10 ist besonders geeignet für Spülmaschinen.

Polycarbonat. PC

Il polycarbonato è un polimero di pregio che racchiude alcune Das Polycarbonat ist ein hochwertiges Polymer, es hat einige Merkmale des Kunststoffes, des Stahls und des Glases. Die Transparenz beträgt fast 90%. Die mechanische Verformungsbeständigkeit hat eine hohe Schlagfestigkeit.

Die hohe Maßhaltigkeit wird bis 130° garantiert. Bei Flammen selbstlöschend.

Both I caldi and the Dispenser are made in special fireproof MDF.

Hinweise: Nicht beständig gegen a) Alkalilösungen, Azeton, Ammoniak, Benzol und Methylalkohol. Physiologisch ist das Material sicher und darf mit Lebensmitteln in Berührung kommen.

Komponenten aus MDF und Holz

MDF (Medium Density Fibreboard, Faserpaneel mit mittlerer Dichte) ist ein Holzderivat: es ist das berühmteste und am weitest verbreitete aus der Familie der Faserpaneele.

Hinweise. Damit das Produkt lange seine gute Qualität behält, muss folgendes beachtet werden:

- Nicht in Flüssigkeit oder Wasser eintauchen
- Mit einem mit Wasser befeuchteten Tuch reinigen
- Keine Scheuer- und Lösungsmittel verwenden
- Von offenem Feuer und Wärmequellen fernhalten
- Vor langer Sonneneinwirkung schützen, um Farbveränderungen und Verformungen zu vermeiden Achtung.

Da Holz ein Naturprodukt ist, können je nach Temperatur und Umgebung Feuchtigkeit verschiedene Toleranzen auftreten.

Das Holzschneidbrett ist gesetzlich garantiert, wurde behandelt, um Geruch- und Feuchtigkeitsaufnahme zu vermeiden. Von Hand spülen und abtrocknen.

Polypropylen

Das Polypropylen hat eine hohe Festigkeit und ist für Lebensmittel gewährleistet.

Widerstände

Für eine Spannung von 220 Volt geeignet mit Schukostecker ausgestattet. Das Heizelement für Getränkespender oder Chafing Dish darf nicht mit leeren Behältern betrieben werden. Um das Heizelement nicht zu beschädigen und korrekt zu verwenden bitte unbedingt die Gebrauchsanweisung in der Verpackung beachten.



Notas informativas sobre los componentes

El acero inoxidable 18/10

El acero inoxidable 18/10 AISI 304 es suministrado casi exclusivamente por las principales acerías europeas. Su resistencia excepcional a la oxidación, su brillo y las características higiénicas satisfacen los requisitos de la gastronomía moderna; resiste a los ácidos contenidos en los géneros alimenticios y en los detergentes y es antiochoque.

El acero 18/10 está especialmente indicado para el lavado en lavavajillas.

Polycarbonato. PC

El polycarbonato es un polímero de alta calidad que reúne algunas características del plástico, del acero y del vidrio. Su transparencia se acerca del 90%.

Su resistencia mecánica a la deformación presenta una elevada resistencia a los golpes. Su elevada estabilidad dimensional está garantizada hasta la temperatura de 130 grados.

En presencia de llamas, es autoextinguible.

Todos aquellos elementos destinados a mantener el calor y distribuir bebidas se realizan en mdf especial e ignífugo.

Advertencias: no resiste a: soluciones alcalinas, acetona, amoníaco, bencol y alcohol metílico.

El material es seguro desde el punto de vista fisiológico y es apto para el contacto con alimentos.

Componentes de MDF y de Madera

El MDF (Medium Density Fibreboard, panel de fibra de media densidad) es un derivado de la madera: es el más famoso y difundido de la familia de los paneles de fibra.

Advertencias. Para mantener durante largo tiempo la calidad del producto es necesario:

- No sumergir en líquidos o en agua
- Limpiar con un paño humedecido con agua
- Evitar la utilización de sustancias abrasivas o disolventes
- Mantener alejado del fuego o de fuentes de calor
- Evitar la exposición prolongada al sol, para evitar variaciones de color y deformaciones.

N.B. Al ser la madera un producto natural, puede asumir tolerancias diversas según la temperatura y la humedad presentes en el ambiente circunstante.

Pueden encontrarse diferentes gradaciones de color y vetas ya que el producto es de madera natural.

La tabla de cortar de madera de haya natural, está garantizado según la normativa de ley, tratadas para no absorber olores y para retener la humedad.

Tienen que ser lavadas a mano y secadas.

Polipropileno

El polipropileno es de alta resistencia y garantizado para su uso con alimentos.

Resistencias

Adecuadas a un uso de 220 voltios y dotadas de enchufe schuko. Conforme a la normativa de la cee. Pour distributeur boissons chaudes et chafing dish. Ne pas utiliser avec distributeur boisson chaudes et chafing dish vides. Pour une utilisation correcte merci de lire le mode d'emploi dans la boîte.

In ottemperanza a quanto stabilito dal decreto legislativo DL 108 dt 25.01.92 e Dir. CEE 1935/2004 e 89/109, si precisa che la posateria, il pentolame e il vasellame di nostra produzione sono prodotti con materiali idonei al contatto con gli alimenti.
In compliance with what defined in the ministerial decree DL 108 dt 25.01.92 and Dir. CEE 1935/2004 and 89/109, the cutlery and the holloware we manufacture are produced with materials which can be touch with foodstuff.



**CLUB
DEL BUONGUSTAIO**
Collana della gastronomia europea





DNV BUSINESS ASSURANCE MANAGEMENT SYSTEM CERTIFICATE

Certificato No. / Certificate No. **CERT-07553-2000-AQ-MIL-SINCERT**

Si attesta che / This is to certify that

PINTI INOX S.p.A.

Via Antonini, 87 - 25068 Sarezzo (BS) - Italy



*è conforme ai requisiti della norma per i sistemi di gestione:
has been found to conform to the management system standard:*

UNI EN ISO 9001:2008 (ISO 9001:2008)

*Questo Certificazione è valida per il seguente campo applicativo:
This Certificate is valid for the following product or service ranges:*

**Progettazione e produzione di: posateria, pentolame per uso domestico, alberghiero e catering
e oggetti in acciaio inox per la tavola e la cucina
(Settore EA : 17)**

*Design and manufacture of: cutlery, cookware for domestic, hotels and catering uses,
stainless steel tableware and kitchen accessories
(Sector EA : 17)*

<p><i>Data Prima Emisione/Initial Certification Date:</i> 2000-12-14</p> <p><i>Il Certificato è valido fino al: This Certificate is valid until:</i> 2018-03-04</p> <p><i>L'audit è stato eseguito sotto la supervisione di/ The audit has been performed under the supervision of</i></p> <p>Alessandra Gadaleta <i>Lead Auditor</i></p>	 <p><small>ACCREDITAZIONE PER IL SISTEMA DI CERTIFICAZIONE UNI EN ISO 9001:2008 E PER IL SISTEMA DI CERTIFICAZIONE UNI EN ISO 14001:2004 E PER IL SISTEMA DI CERTIFICAZIONE UNI EN ISO 22716:2008 E PER IL SISTEMA DI CERTIFICAZIONE UNI EN ISO 22717:2008</small></p>	<p><i>Luogo e Data/Place and Date:</i> Vimercate (MB), 2015-02-04</p> <p><i>Per l'Organismo di Certificazione: For the Certification Body:</i></p> <p></p> <p>Zeno Beltrami <i>Management Representative</i></p>
--	---	---

La validità del presente Certificato è subordinata al rispetto delle condizioni contenute nel Contratto di Certificazione.
Lack of fulfilment of conditions as set out in the Certification Agreement may render this Certificate invalid.

DNV GL Business Assurance Division S.p.A. - Via Salaria 700, 14 - 00197 Roma (RM) - Tel. +39 06 6909 - www.dnvgl.com



CONFINDUSTRIA

UNIONE NAZIONALE CONSUMATORI
COMITATO PROVINCIALE DI BRESCIA