



# LALIQUE

CATALOGUE 2020

ARCHITECTURE D'INTÉRIEUR

*INTERIOR DESIGN*

# SOMMAIRE - TABLE OF CONTENT

<b>INTRODUCTION</b>	<b>4</b>	<b>TABLES / TABLES</b>	<b>81</b>
<b>LUMINAIRES / LIGHTINGS</b>	<b>11</b>	CACTUS	81-83
<b>APPLIQUES / WALL SCONCES</b>	<b>12</b>	CHÊNE	84
2 PERRUCHES	12	COUTARD	85
AURORA CRISTALIGHT	13	<b>TABLES BASSES / COFFEE TABLES</b>	<b>86</b>
CHAMPS-ÉLYSÉES	14	PERLES D'EAU / WATER PEARLS	86
CHÊNE	15	VERSAILLES	87
GINKGO	16-17	<b>VANITY / VANITY</b>	<b>88</b>
HÉLICONIA	18	CAUSEUSES	88
KORA CRISTALIGHT	19	<b>ASSISES / SEATINGS</b>	<b>89</b>
ORGUE	20	<b>CHAISE CONTEMPORAINE</b>	<b>90</b>
PALME	21	CONTEMPORARY CHAIR	90
SERENE	22-26	COUTARD	90-91
SÉVILLE	27	<b>AUTRE MOBILIER</b>	<b>93</b>
<b>LAMPES / LAMPS</b>	<b>28</b>	<b>OTHER FURNITURE</b>	<b>93</b>
COUTARD	28	<b>MIROIRS / MIRRORS</b>	<b>94</b>
FAUNES	29	LES CAUSEUSES	94
GINKGO	30	MERLES ET RAISINS	95
HIRONDELLES	31	OCÉANIA	96
MASQUE DE FEMME	32	RINCEAUX	97
MOSSI	33	<b>POIGNÉES DE PORTE ET BOUTONS</b>	<b>98</b>
POSÉIDON	34	DOOR HANDLES AND KNOBS	98
SERENE	35	FAUNES	98-99
VERSAILLES	36	BUCOLIQUE	100
<b>LANTERNES / LANTERNS</b>	<b>37</b>	MASQUE DE FEMME	101
COUTARD	37-38	MÉTROPOLIS	102
GINKGO	39	PERLES	103
<b>LUSTRES / CHANDELIERS</b>	<b>40</b>	<b>PANNEAUX DÉCORATIFS &amp; PANNEAUX</b>	<b>105</b>
CHAMPS-ÉLYSÉES	40-44	<b>D'ESPACE - DECORATIVE PANELS &amp;</b>	<b>105</b>
CHÊNE	45	<b>INTERIOR PANELS</b>	<b>105</b>
GINKGO	46	<b>1. PANNEAUX DÉCORATIFS</b>	<b>106</b>
HIRONDELLES	47-48	DECORATIVE PANELS	106
ORGUE	49-51	COUTARD	115
PERLES	52	FEMME BRAS LEVÉS	116-117
PLUME	53	FEMME TÊTE LEVÉE	118
SERENE	54-61	FIGURINE ET RAISINS	119
<b>PLAFONNIER / CEILING LIGHT</b>	<b>62</b>	JOUEUR DE PIPEAU	120
CORALLINE	62	LAURIERS	121
<b>SUSPENSIONS / CEILING LAMPS</b>	<b>63</b>	LES CAUSEUSES	122
COUTARD	63	MASQUE DE FEMME	123
GINKGO	64-65	MERLES ET RAISINS	124-127
PLUME	66	PETITES BULLES	128
SERENE	67-69	RAISINS	129-130
VIBRATION	70	ROSES	131
<b>TABLES &amp; MEUBLES DE RANGEMENT</b>	<b>71</b>	SOUDAN	132
<b>TABLES &amp; CABINETS</b>	<b>71</b>	VIBRATION	133
<b>BUREAU / DESK</b>	<b>72</b>	<b>2. PANNEAUX DÉCORATIFS ENCADRÉS</b>	<b>136</b>
COUTARD	72	FRAMED DECORATIVE PANELS	136
<b>COMMODE / DRAWER UNIT</b>	<b>73</b>	FEMME BRAS LEVÉS	137
VIBRATION	73	FEMME TÊTE LEVÉE	138
<b>CONSOLES / CONSOLES</b>	<b>74</b>	FIGURINE ET RAISINS	138
CACTUS	74-75	JOUEUR DE PIPEAU	139
SÉVILLE	76	MASQUE DE FEMME	140
<b>GUÉRIDONS / PEDESTAL TABLES</b>	<b>77</b>	MERLES ET RAISINS	141
MARSAN	77		
ROSES	78		
SOUDAN	79		
VERSAILLES	80		

# SOMMAIRE - TABLE OF CONTENT

<b>3. PANNEAUX D'ESPACE</b> <i>INTERIOR PANELS</i>	<b>142</b>	<b>CONSOLES / CONSOLES</b>	<b>188</b>
BOUQUET	148	LONGCHAMP	188
DAHLIA	149	MASQUE DE FEMME	189-190
LANGUEDOC	150-151	RAISINS	191-192
VENISE	152	ROSES	193
<b>ÉCHANTILLONS / SAMPLES</b>	<b>153</b>	<b>CRÉDENCES / SIDEBOARDS</b>	<b>194</b>
BOUQUET	153	DRAGON	194
DAHLIA	153	MASQUE DE FEMME	195
LANGUEDOC	154	RAISINS	196-197
VENISE	154	<b>TABLES / TABLES</b>	<b>198</b>
<b>LALIQUE MAISON</b>	<b>155</b>	RAISINS	198-199
<b>LUMINAIRES / LIGHTINGS</b>	<b>159</b>	<b>TABLES D'APPOINT / SIDE TABLES</b>	<b>200</b>
<b>LAMPES / LAMPS</b>	<b>160</b>	MASQUE DE FEMME	200
FEMME BRAS LEVÉS	160	RAISINS	201-202
JOUEUR DE PIPEAU	161	<b>TABLES BASSES / COFFEE TABLES</b>	<b>203</b>
MERLES ET RAISINS	162	MASQUE DE FEMME	203
RAISINS	163-166	RAISINS	204-206
<b>TABLES &amp; MEUBLES DE RANGEMENT / TABLES &amp; CABINETS</b>	<b>167</b>	<b>TABLES DE CHEVET / BEDSIDE TABLES</b>	<b>207</b>
<b>ARMOIRES / CABINETS</b>	<b>168</b>	MASQUE DE FEMME	207
FEMME BRAS LEVÉS	168	RAISINS	208-209
MERLES & RAISINS	169	<b>TABLES GIGOGNES / SIDE TABLES (NESTING TABLES)</b>	<b>210</b>
<b>BARS / BARS</b>	<b>170</b>	MASQUE DE FEMME	210
DRAGON	170	RAISINS	211
FEMME BRAS LEVÉS	171	<b>VITRINE / DISPLAY UNIT</b>	<b>212</b>
JOUEUR DE PIPEAU	172	DAHLIA	212
LONGCHAMP	173	RAISINS	213
MASQUE DE FEMME	174	<b>ASSISES / SEATINGS</b>	<b>215</b>
MERLES ET RAISINS	175	<b>CANAPÉS CLASSIQUES / CLASSIC SOFAS</b>	<b>216</b>
RAISINS	176-177	RAISINS	216-217
<b>BIBLIOTHÈQUES / LIBRARIES</b>	<b>178</b>	<b>CANAPÉS CONTEMPORAINS CONTEMPORARY SOFAS</b>	<b>218</b>
RAISINS	178-179	MASQUE DE FEMME	218-221
<b>BUREAUX / DESKS</b>	<b>180</b>	RAISINS	222
RAISINS	180	<b>CHAISES CONTEMPORAINES CONTEMPORARY CHAIRS</b>	<b>223</b>
<b>CABINET / CABINET</b>	<b>181</b>	MASQUE DE FEMME	223-224
RAISINS	181	RAISINS	225
<b>COIFFEUSES / DRESSING TABLES</b>	<b>182</b>	<b>CHAISES CLASSIQUES / CLASSIC CHAIRS</b>	<b>226</b>
MASQUE DE FEMME	182	MASQUE DE FEMME	226-227
RAISINS	183-184	<b>FAUTEUILS CONTEMPORAINS VILLA RENÉ LALIQUE VILLA RENÉ LALIQUE CONTEMPORARY ARMCHAIRS</b>	<b>228</b>
<b>COMMODOES / DRAWER UNIT</b>	<b>185</b>	MASQUE DE FEMME	228
RAISINS	185	RAISINS	229
<b>COMMODOES / TALL BOY</b>	<b>186</b>	<b>CHAISES DE BAR / BARSTOOL</b>	<b>230</b>
MASQUE DE FEMME	186	MASQUE DE FEMME	230
RAISINS	187	<b>FAUTEUILS CLUB CLASSIQUES CLASSIC CLUB ARMCHAIRS</b>	<b>231</b>
		RAISINS	231
		<b>FAUTEUILS CLUB CONTEMPORAINS CONTEMPORARY CLUB ARMCHAIRS</b>	<b>232</b>

# SOMMAIRE - TABLE OF CONTENT

MASQUE DE FEMME	232	<b>LINGE DE TOILETTE / BATH LINEN</b>	<b>267</b>
<b>FAUTEUILS / ARMCHAIRS</b>	<b>233</b>	<b>CARRÉS BRODÉS /</b>	<b>267</b>
LONGCHAMP	233	<i>EMBROIDERED SQUARE TOWELS (FACE CLOTH)</i>	
PANTHÈRE	234	LALIQUE	267
VICTOIRE	235	<b>LINGE DE TOILETTE / BATH LINEN</b>	<b>268</b>
<b>OTTOMANS / OTTOMANS</b>	<b>236</b>	RAISINS	268
MASQUE DE FEMME	236-237	<b>PEIGNOIR BRODÉ</b>	<b>269</b>
RAISINS	238-239	<i>EMBROIDERED BATHROBE</i>	
<b>AUTRE MOBILIER</b>		HIRONDELLES	269
<b>OTHER FURNITURE</b>	<b>241</b>	<b>TAPIS DE BAIN BRODÉS</b>	<b>270</b>
<b>CADRES TV / TV FRAMES SURROUND</b>	<b>242</b>	<i>EMBROIDERED BATH MATS</i>	
RAISINS	242	HIRONDELLES	270
<b>MIROIRS / MIRRORS</b>	<b>243</b>	<b>LINGE DE TABLE / TABLE LINEN</b>	<b>271</b>
MASQUE DE FEMME	243	<b>SERVIETTES ET SETS DE TABLE</b>	<b>271</b>
RAISINS	244-246	<i>NAPKINS AND PLACEMATS</i>	
ROSES	247	1 HIRONDELLE	271
TIANLONG	248	4 HIRONDELLES	272
<b>LITS / BEDS</b>	<b>249</b>	2 POISSONS / KOI CIRCLE	273
MASQUE DE FEMME	249	RINCEAUX / SCALLOP	274
RAISINS	250		
<b>LINGE DE MAISON</b>			
<b>SOFT FURNISHING</b>	<b>251</b>		
<b>COUSSINS / CUSHIONS</b>	<b>252</b>		
2 POISSONS / KOI CIRCLE	252		
CHEVAL BONDISSANT/ LEAPING HORSE	253		
CHEVAL DEBOUT/ STANDING HORSE	254		
COUTARD	255		
DEMI COUTARD	256		
DRAGON	257		
HIRONDELLES	258		
MASQUE DE FEMME	259-260		
PANTHÈRE/ PANTHER	261		
<b>LINGE DE LIT / BED LINEN</b>	<b>262</b>		
<b>COUVRE-LITS PERLÉS / BEADED BED-COVERS</b>	<b>262</b>		
RAISINS	262		
<b>DRAPS BRODÉS</b>			
<i>EMBROIDERED TOP FLAT SHEETS</i>	<b>263</b>		
RAISINS	263		
<b>DRAPS HOUSSE</b>			
<i>PLAIN FLAT BOTTOM SHEETS</i>	<b>264</b>		
RAISINS	264		
<b>HOUSSES DE COUETTE BRODÉES</b>			
<i>EMBROIDERED DUVET COVERS</i>	<b>264</b>		
RAISINS	264		
<b>TAIES D'OREILLER BRODÉES</b>			
<i>EMBROIDERED PILLOW CASES</i>	<b>265</b>		
OXFORD	265		
RAISINS	266		

# INTRODUCTION

---



## **LALIQUE... LA MAGIE D'UN NOM, LE GÉNIE D'UN CRÉATEUR**

Un passé, une histoire qui se confondent avec l'histoire des Arts décoratifs et du XX<sup>e</sup> siècle.

Attentif aux êtres et à la nature, doué de dons exceptionnels, René Lalique commence sa carrière de créateur dans la joaillerie. Bijoutier-poète le plus célèbre de la Belle époque, il devient le maître absolu du bijou Art Nouveau où il mêle symbolisme et naturalisme. S'inspirant des artistes japonais, remettant au goût du jour des techniques et des matières telles la corne, l'émail, l'ivoire ou le verre, depuis longtemps délaissées, il est l'inventeur du bijou moderne. Dès le début du XX<sup>e</sup> siècle, il connaît la gloire, fournit les cours d'Europe, les musées et les collectionneurs.

En 1907, René Lalique se passionne pour le verre qu'il avait introduit dans ses bijoux. L'artisan - créateur se transforme en industriel, réinventant le flacon de parfum, mettant au point le verre opalescent. Artiste génial, il décore l'Orient Express, le paquebot Normandie, crée les fontaines du rond-point des Champs Elysées, de nombreux objets, du plus usuel au plus audacieux, contrôlant et affinant transparence et reflets, avec là encore un succès international jusqu'à sa mort en 1945.

Il reste le maître incontesté d'un style et d'une matière... le verre.

Ses successeurs ont imposé définitivement le cristal en restant fidèles à l'esprit de René Lalique. Aujourd'hui, un atelier de création perpétue son savoir-faire et son style.

## **LALIQUE... THE MAGIC OF A NAME THE GENIUS OF A CREATOR**

*A past, a history tied-in with the history of decorative arts and the 20th century.*

*Attentive to living beings and nature, and endowed with exceptional gifts, René Lalique started his career in jewellery. This artist jeweller and poet was the most famous name of the Belle époque. He became the absolute master of the Art nouveau jewel, in which he blended symbolism and naturalism, inspired by Japanese artists, and remodelled long-abandoned techniques and materials such as horn, enamel, ivory and glass to please contemporary tastes. Lalique was the inventor of modern jewellery. From the beginning of the 20th century, he became famous, a purveyor to the courts of Europe, museums and collectors.*

*In 1907, René Lalique acquired a passion for glass, which had become an element of his works. The artist craftsman became a manufacturer, reinventing the perfume bottle and developing opalescent glass. He decorated the Orient Express and the Normandy cruise ship, designed the fountains on the Rond Point des Champs Elysées, and produced a host of objects - from the more mundane to the most daring - controlling and refining transparency and reflection, with an international success that continued to his death in 1945.*

*He remains the undisputed master of a style and of a material : glass.*

*His successors have definitively imposed crystal, while remaining faithful to the spirit of René Lalique. Today, a crystal design shop carries on his skill and knowledge and his style.*

# INTRODUCTION

---

## UN SAVOIR-FAIRE EXCEPTIONNEL AU SERVICE DE LA CRÉATION ET DE L'ÉMOTION

Depuis 1921, la Manufacture installée en Alsace, région de tradition verrière, perpétue un savoir-faire artisanal. La main de l'homme, artiste - artisan de la matière, marque les objets de son empreinte et leur confère cette force, cette présence très «immatérielle» : notre savoir-faire.

Le style Lalique naît sous le geste de l'artiste esquissant un dessin en osmose totale avec la matière, un style reconnaissable au modelage manuel des pièces et des décors, comme une sculpture, à la richesse du décor figuratif, aux finitions qui donnent ce contraste caractéristique de cristal clair et satiné. Une culture de la douceur, de la féminité, de la nature nourrie d'une forte inspiration Art Nouveau et Art Déco.

### **Sculpteur de lumière...**

Quand ce qui est contenu dans la matière naît à la lumière...

Lalique, la seule marque de cristal qui, dans un geste artistique, métamorphose la matière brute, fusion à 1 400° de silice et de plomb, en des objets uniques qui méritent le statut d'œuvres d'art.

## LA MANUFACTURE

Tous les produits Lalique sont, pour le monde entier, fabriqués à la manufacture de Wingen sur Moder. On y cultive la tradition de ce savoir-faire qui transmis depuis des générations, forge l'identité et la mémoire de chaque pièce. Notre Manufacture est fière de compter parmi ses artistes 7 Meilleurs Ouvriers de France. Cette distinction s'acquiert à l'issue d'un concours national ayant lieu tous les 3 ans où ils sont jugés par leurs pairs sur un travail de recherche et un ouvrage d'art, faisant preuve de leur talent. Ils doivent y faire apparaître leur dextérité, leurs connaissances techniques évolutives, leur créativité et



## LALIQUE: EXCEPTIONAL KNOW HOW SERVING CREATIVITY AND EMOTION

*Since 1921, the Manufacture located in Alsace, area renowned for its glassmaking, has perpetuated an traditional know-how.*

*The human hand, that of both artist and craftsman, marks every object of its print and its strength, which convey this "immaterial" presence: our know-how.*

*The Lalique style comes from an artistic gesture, outlining a drawing in total osmosis with crystal, a style that one easily recognises through the manual modelling of the shapes and patterns, as if sculptured, the richness of the figurative details, the different types of finishing which create this characteristic contrast of clear and matt crystal. An identity built by softness, femininity, nature with strong Art nouveau and Art Deco inspirations.*

### **Light sculptor...**

*When what is contained in the matter is revealed through the light...*

*Lalique, the only crystal Brand which, through an artistic gesture and the fusion at 1 400° C of lead and sand, metamorphoses raw material into unique artworks.*

## THE MANUFACTURE

*All Lalique items are, for the whole world, manufactured in Wingen on Moder-France. One cultivates there the tradition of this priceless know-how. Transmitted since generations, it has forged the identity and the memory of each creation. Our Manufacture is proud to count among its artists 7 "Meilleurs Ouvriers de France". This distinction is acquired at the end of a national contest taking place every 3 years, where they are evaluated by their peers on a research task and an artwork, showing their talent. These must express their dexterity, their evolutive technical skills, their creativity, their mastery of both modern techniques and*

# INTRODUCTION

---

tout autant l'usage de techniques modernes que le respect des méthodes traditionnelles. En toute humilité, nos Maîtres verriers sont fiers de leur savoir-faire. Ils fabriquent eux-mêmes certains de leurs outils et reprennent des gestes anciens, transmis de génération en génération, les mêmes instruments pour venir cueillir, du bout de leur canne, le cristal en fusion. C'est alors, une étrange chorégraphie faite de souffles, de tournolements et de gestes mesurés. Il s'agit d'arrondir la matière, de calmer le cristal, de lui donner forme, de lui donner vie.

## **L'alchimie du cristal**

La magie du cristal s'opère dans la fusion, étape par laquelle le sable, la potasse, le minium de plomb et le groisil se métamorphosent, suivant des dosages qui restent un secret jalousement conservé, en une matière brillante, lumineuse et à la sonorité si particulière qui le distingue du verre.

## **La couleur**

La recherche sur les couleurs est une caractéristique du style Lalique. À la composition de base sont ajoutés différents oxydes de métaux ou terres rares, chacun donnant une teinte au cristal. Ces mélanges, mis au point avec minutie, permettent de disposer aujourd'hui d'une palette riche de plus de 100 couleurs et nuances. Certaines teintes sont plus difficiles à travailler comme le noir, le rouge, l'ambre, l'antinéa ou l'opale. Par exemple, pour conserver sa transparence au cristal opalescent, nous n'utilisons la composition d'un creuset qu'une seule journée. Chaque jour, les Maîtres Verriers vident les pots de la matière et la remplacent par une nouvelle composition. Les pièces réalisées en rouge à l'or requièrent également un haut degré de maîtrise technique et de la patience car elles sortent incolores du travail au verre chaud, la couleur ne se révélant qu'après la cuisson qui, par exemple, dure 6 jours sur le vase *Serpent*. Un cycle de couleur doit être respecté pour une utilisation optimale du pot : des couleurs claires aux couleurs foncées. Ainsi, après une composition de cristal noir, le pot devient inutilisable.

## **Poterie & moulerie**

Lalique est une des seules manufactures à fabriquer encore ses pots ou creusets, fabriqués à la main dans une argile pure, et dans lesquels sera fondu le cristal. De la qualité de cette argile dépend la qualité des pots et donc celle du cristal. La fabrication des pots dure environ 9 mois à l'issue desquels il sera enfin possible de déterminer si le pot est apte à être enfourné. La Manufacture réalise également ses propres moules en fonte, dont une intèrioriste sculpte chaque détail pour rendre l'œuvre conforme à l'esprit de son créateur.

*traditional methods. With much humbleness, our glass Masters are proud of their know-how. They make some the tools they works with and take up old gestures, transmitted from generation to generation, the same instruments to gather the molten crystal. This amazing choreography is made of blowing, whirling and measured gestures. It is a question of taming the matter, calming the molten crystal, to define a shape and give life to the item.*

## **The alchemy of crystal**

*The Magic of crystal takes place in the fusion. At this stage, the sand, potash, lead oxide and recycled crystal (cullet) mixed in proportions which remain a jealously kept secret, metamorphose into brilliant and luminous crystal, with this particular sonority that distinguishes it from mere glass.*

## **The colour**

*Research on the colours is characteristic of Lalique style. Various metal oxides or rare types of earth are added to the basic composition, each one giving a specific colour to the crystal. These meticulously developed mixtures allow us to obtain a pallet rich of more than 100 colours and shades. Some colours are more difficult to work on such black, red, amber, antinéa or opalescent. For example, to preserve the transparency of opalescent crystal, we chose to use the composition molten in a pot only one day. Every day, Glass Masters empty the pots of the matter and replace it by a new composition. The pieces carried out in red with gold also require a high degree of technical mastery and a lot of patience since they remain clear at the end of the hot glass stage, the colour appearing only after the re heating which, for example, lasts 6 days on the "Serpent" vase. A colour cycles must be respected for optimal use of the pots: from light colours to darker ones. Thus, once a pot has served to melt black crystal, it becomes unusable.*

## **Pottery, moulding**

*Lalique is one of last crystal Brand to still handcraft its pots (or crucibles), made with pure clay and in which the crystal is molten. The quality of this clay determines that of the pots and thus, that of crystal. Making a pot takes approximately 9 months. Only then can one tell whether the pot can be charged in the furnace. Our manufacturer also handcrafts its own cast iron moulds. A sculptor ("intèrioriste") sculpts each detail of these moulds to respect the intentions of the Creation Studio.*

# INTRODUCTION



Remarquez le courage de ces hommes qui, dans leurs tenues de protection, bravent des températures extrêmes dans un ballet spectaculairement orchestré, pour placer les pots dans le four à plus de 1 800°C. Une fois le pot installé, la montée en température du cristal dure deux jours.

*One should notice the courage of these men who, in their protective outfits, face extremely high temperatures in a spectacularly orchestrated ballet, to place the pots in the furnace at more than 1 800°C. Once the pot installed, the rise in temperature of the crystal takes two days.*

## LE TRAVAIL AU VERRE CHAUD

### Le Cueillage

La fabrication s'articule autour de 2 étapes essentielles : «le verre chaud» et le «verre froid». L'étape du Verre Chaud comprend les opérations de cueillage, de nettoyage puis de mise en forme et de recuisson.

Le cristal en fusion est «cueilli» au centre du creuset par le Maître Verrier au moyen d'une canne. Les boules de feu se croisent alors furtivement dans une cadence parfaitement orchestrée par le chef de place. Pour les grandes pièces, le cueillage est réalisé en plusieurs fois et peut atteindre 30 kg de matière en fusion. Les bulles et imperfections sont ôtées de cette boule de feu aux ciseaux.

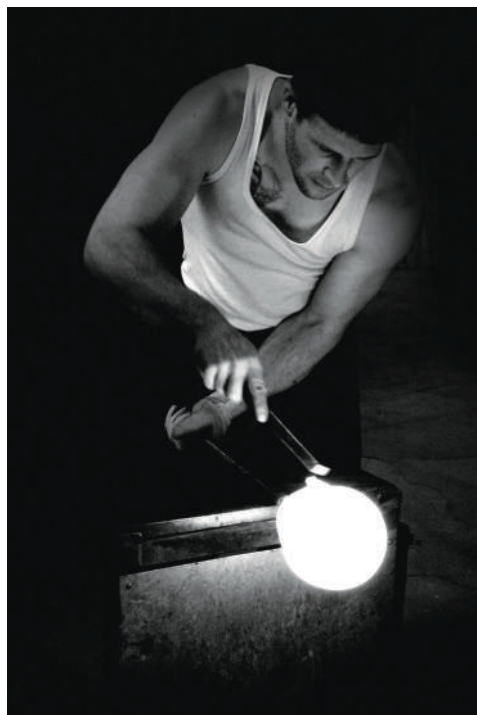

## HOT WORK PROCESS

### Gathering crystal

*The manufacturing process comprises 2 essential stages: the "hot glass" and "cold glass" processes. The stage of Hot Glass process includes the operations of gathering, cleaning, shaping and re heating. Each piece is born from fusing crystal, the fruit of a battle with time and temperature. The molten crystal is gathered at the centre of the crucible by the Glass Master with a cane. The fireballs then cross furtively in a rate perfectly orchestrated by the chief of place. For large items, the gathering is carried out in several times and can reach up to 30 kg of molten crystal. Cleaning consists in removing every bubbles and imperfections are removed from these fireballs with scissors.*



# INTRODUCTION

---

## **La mise en forme et la recuisson**

La pièce est mise en forme selon différentes techniques qui vont du soufflé fixe au soufflé tourné en passant par le pressé sur une presse à balancier manuel. L'objet est ensuite transporté à l'aide du pontil jusqu'à l'arche de recuisson, dans laquelle il est déposé sur un tapis roulant, où suivant des paliers de températures décroissants, il se refroidit peu à peu. Cette étape permet de stabiliser les tensions internes du cristal. Sans elle, la pièce éclaterait au moindre choc.

## **LE TRAVAIL AU VERRE FROID**

### **Taille & retouche**

L'ébauche ainsi obtenue va subir, dans les ateliers de travail à froid, une suite d'opérations manuelles qui représentent les 3/4 du temps consacré à la fabrication de chaque objet. Ainsi, une pièce passe en moyenne entre les mains de 20 personnes, dont un minimum de 12 personnes au verre froid. Cette importance donnée au verre froid, qui fait la particularité de Lalique, s'explique par l'extrême attention portée au détail, aux finitions et à la sculpture des pièces. Cette étape du Verre Froid comprend les opérations de taille et retouches et les finitions. La taille et la retouche permettent de reprendre la surface afin d'éliminer les imperfections laissées par le travail à chaud (coutures de moule, plis...).

### **Sculpture et finitions**

Commence alors un véritable travail de sculpture : les arrêtes sont avivées, certains détails sont soulignés par gravure pour redonner de la nervosité à la pièce et la rendre conforme à l'intention de la création. Ainsi, le mouvement d'une chevelure, la colonne vertébrale d'un nu ou le détail de l'expression d'un visage seront resculptés.

Viennent ensuite les finitions. Il en existe plusieurs, pouvant être combinées sur une même pièce et toujours entièrement réalisées à la main. Le polissage, le satinage, le sablage, le matage, l'émaillage au pinceau sont nos finitions privilégiées, mises au service de la création qui recherche toujours à trouver l'osmose entre le décor, les finitions et la matière.

## **Shaping and re heating**

*The item is shaped according to various techniques which range from "soufflé fixe" (fixed while blown) to "soufflé tourné" (turned while blown) or "pressé" then carried with the help of a tool called "pontil" to the re heating arch. It is set down on a conveyor belt, and goes through decreasing temperatures to cool off gently. This stabilises the internal tensions of crystal. Otherwise, the piece would burst at the smallest shock.*

## **THE COLD WORK PROCESS**

### **Cutting and touching up**

*The outline thus obtained will undergo a succession of manual operations in the workshops of cold work. These represent 3/4 of the time spent to the manufacture of each object. Thus, each piece is manipulated by the hands of 20 persons, with a minimum of 12 persons at the cold work process. This importance given to cold glass, is characteristic of Lalique. It is the result of the extreme attention given to details, finishing and to the sculpture of each creation. This stage of Cold Glass includes the operations of cutting, touching up and the finishing. The cutting, touching up consist in improving the surface in order to eliminate any imperfections left at the hot work stage. (seams of the moulds...).*

### **Sculpting and finishing**

*Each object is sculpted to highlight each detail and give both life and movement, following the intention of the Creation Studio. Thus, the hair or vertebral column of a nude, the details of a face are re sculpted. The items then undergo the finishing process. There are several types of finishing, which can be combined together. Polishing, satin-finish, sanding, matt-finish, enamelling by hand are our favourite. The technique used depends on the required aspect of the item. The creation studio considers all the parameters to find the perfect osmosis between the decor, the finishing and the material.*

# INTRODUCTION

---

## LE CHOIX

Chez Lalique, on parle volontairement de choix plutôt que de contrôle qualité : les pièces sont en effet choisies non seulement en fonction de critères techniques (absence de défauts) mais aussi suivant des critères esthétiques, dans le respect de l'esprit de la création.

Chaque pièce doit passer avec succès plusieurs étapes de choix intermédiaires avant d'être revêtue de la signature Lalique réalisée à main levée, au moyen d'une pointe diamantée, preuve de son authenticité et de sa qualité.

## THE CHOICE

*At Lalique, one voluntarily speaks about "choice" rather than of "quality control": the objects are selected not only according to technical criteria (absence of defects) but also according to aesthetic criteria, with full respect of the creation's intentions. Each item must pass successfully several intermediary choices before they can be signed by hand, sign of its authenticity and quality.*



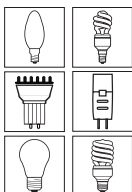

Ampoule fluorescente, halogène  
et LED E12 - E14 - E26 - E27 - G9 - G4 /  
*Fluorescent, halogène and LED  
bulb E12 - E14 - E26 - E27 - G9 - G4*

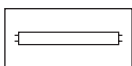

Tube fluorescent / *Fluorescent tube*

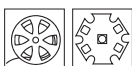

Disques, bandes de LEDs /  
*LED disks, strips*

**EU**

Branchement Europe /  
*Europe plug*

**US**

Branchement USA /  
*USA plug*

**UK**

Branchement Royaume-Uni /  
*United Kingdom plug*

**CE**

Certifié norme CE (230V Europe) /  
*Certified CE standard (230V Europe)*

**UL**

Certifié norme UL (120V US) /  
*Certified UL standard (120V US)*

**IP20**

**IP30**

Ce produit est conçu pour une utilisation intérieure. Il n'est pas destiné à être installé dans une salle de bain ou dans des locaux humides. Le luminaire ne doit pas entrer en contact avec l'eau. /

*This product is designed for internal use. It is not intended to be installed in a bathroom or other damp premises. The light-fitting must not be in contact with water.*



La finition « chromée » correspond dans le catalogue à un rendu argenté.  
*The "chrome" finishing in the catalogue corresponds to a silver rendering.*

LUMINAIRES - *LIGHTINGS*



# APPLIQUES - WALL SCONCES

## 2 PERRUCHES



Incolore / Clear  
Chromé / Chrome

Abat-jour Ø 130 mm  
Lampe shade Ø 5.12"



Incolore / Clear  
Doré / Gilded

4,5 kg / 9.92 pounds



Incolore / Clear  
Doré satiné / Satin Gilded

### FINITION / FINISHING

	REFERENCE	EAN CODE
 CRISTAL INCOLORE - CLEAR CRYSTAL CHROMÉ - CHROME	<b>EUROPE</b> 10611200	 0 90592 89692 1
 CRISTAL INCOLORE - CLEAR CRYSTAL CHROMÉ - CHROME	<b>US</b> 10611300	 0 90592 89691 4
 CRISTAL INCOLORE - CLEAR CRYSTAL DORÉ - GILDED	<b>EUROPE</b> 10631300	 0 90592 89480 4
 CRISTAL INCOLORE - CLEAR CRYSTAL DORÉ - GILDED	<b>US</b> 10631400	 0 90592 89479 8
 CRISTAL INCOLORE - CLEAR CRYSTAL DORÉ SATINÉ - SATIN GILDED	<b>EUROPE</b> 10664300	 0 90592 89480 4
 CRISTAL INCOLORE - CLEAR CRYSTAL DORÉ SATINÉ - SATIN GILDED	<b>US</b> 10664400	 0 90592 89479 8

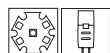

LED x 2 - 9 watts (socle - base) + G9 x 1 - 23 watts (abat-jour - lampshade) - 500 lumens

CE IP44

2700°K - Lumière chaude - Warm light

### 2017 - PIERRE-YVES ROCHON POUR LALIQUE

Détails techniques et instructions de montage : cf fiche architecture. / Technical datas & mounting instructions: see architecture files.

AURORA CRISTALIGHT



FINITION / FINISHING



CRISTAL INCOLORE - CLEAR CRYSTAL  
CHROMÉ - CHROME



CRISTAL INCOLORE - CLEAR CRYSTAL  
CHROMÉ - CHROME

REFERENCE

**EUROPE**  
10084600

**US**  
10084700

EAN CODE



LED x 3 - 3 watts - 280 lumens

**CE IP20** 4100°K - Lumière neutre - Neutral light

2010 - LALIQUE

Détails techniques et instructions de montage : cf fiche architecture. / Technical datas & mounting instructions: see architecture files.

# APPLIQUES - WALL SCONCES

## CHAMPS-ÉLYSÉES

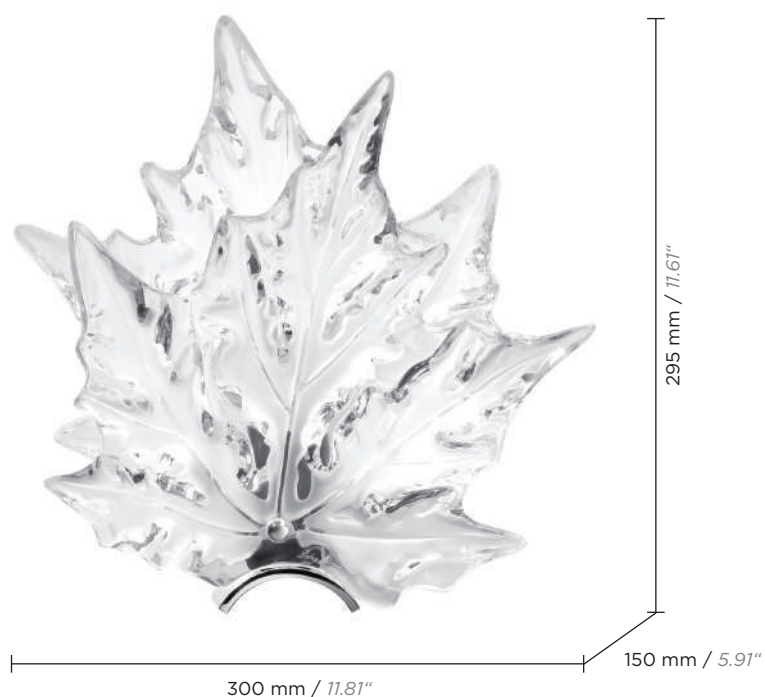

5 kg / 11.02 pounds

Incolore / Clear  
Chromé / Chrome



Incolore / Clear  
Doré / Gilded



Lustré or / Gold luster  
Doré / Gilded

### FINITION / FINISHING

### REFERENCE

### EAN CODE



CRISTAL INCOLORE - CLEAR CRYSTAL  
CHROMÉ - CHROME

**EUROPE**  
1001000



CRISTAL INCOLORE - CLEAR CRYSTAL  
CHROMÉ - CHROME

**US**  
1001099



CRISTAL INCOLORE - CLEAR CRYSTAL  
DORÉ - GILDED

**EUROPE**  
1001100



CRISTAL INCOLORE - CLEAR CRYSTAL  
DORÉ - GILDED

**US**  
1001199



CRISTAL LUSTRÉ OR - GOLD LUSTER CRYSTAL  
DORÉ - GILDED

**EUROPE**  
10584700



CRISTAL LUSTRÉ OR - GOLD LUSTER CRYSTAL  
DORÉ - GILDED

**US**  
10584800



E14 x 1

CE IP20

2700°K - Lumière chaude - Warm light

1957 - Marc Lalique

Détails techniques et instructions de montage : cf fiche architecture. / Technical datas & mounting instructions: see architecture files.

# APPLIQUES - WALL SCONCES

CHÊNE



Incolore / Clear  
Doré / Gilded

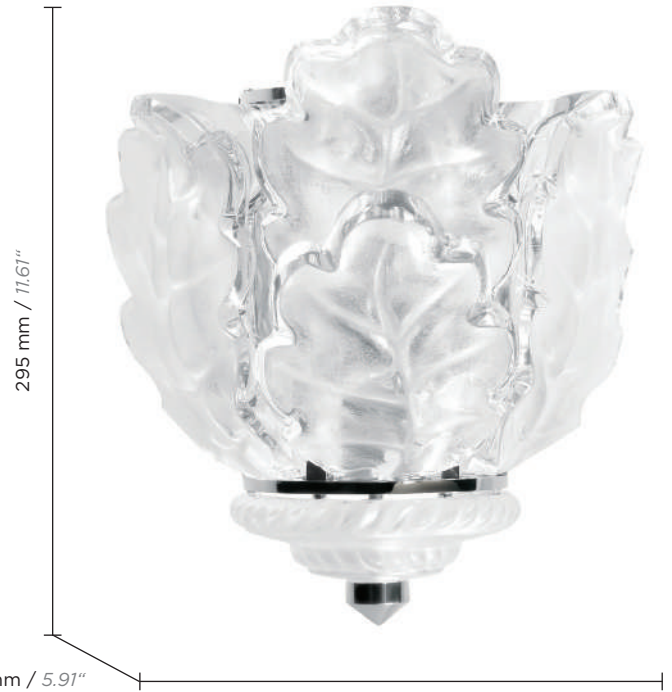

150 mm / 5.91"

245 mm / 9.65"

7,4 kg / 16.31 pounds

Incolore / Clear  
Chromé / Chrome

## FINITION / FINISHING

## REFERENCE

## EAN CODE



CRISTAL INCOLORE - CLEAR CRYSTAL  
CHROMÉ - CHROME

**EUROPE**  
1000900



CRISTAL INCOLORE - CLEAR CRYSTAL  
CHROMÉ - CHROME

**US**  
1000999



CRISTAL INCOLORE - CLEAR CRYSTAL  
DORÉ - GILDED

**EUROPE**  
1001900



CRISTAL INCOLORE - CLEAR CRYSTAL  
DORÉ - GILDED

**US**  
1001999



E14 x 1

CE IP20

2700°K - Lumière chaude - Warm light

1955 - Marc Lalique

Détails techniques et instructions de montage : cf fiche architecture. / Technical datas & mounting instructions: see architecture files.



# APPLIQUES - WALL SCONCES

## GINKGO PM / SS



4 kg / 8.82 pounds

Incolore / Clear  
Chromé / Chrome



Incolore / Clear  
Doré / Gilded

### FINITION / FINISHING

### REFERENCE

### EAN CODE



CRISTAL INCOLORE - CLEAR CRYSTAL  
NICKEL - NICKEL

**EUROPE**  
10577900



CRISTAL INCOLORE - CLEAR CRYSTAL  
NICKEL - NICKEL

**US**  
10578000



CRISTAL INCOLORE - CLEAR CRYSTAL  
DORÉ - GILDED

**EUROPE**  
10578100



CRISTAL INCOLORE - CLEAR CRYSTAL  
DORÉ - GILDED

**US**  
10578200



E14 x 1

CE IP20

4100°K - Lumière neutre - Neutral light

2016 - LALIQUE & DELISLE

Détails techniques et instructions de montage : cf fiche architecture. / Technical datas & mounting instructions: see architecture files.

# APPLIQUES - WALL SCONCES

GINKGO  
MM / MS



5,5 kg / 12.13 pounds

Incolore / Clear  
Chromé / Chrome



Incolore / Clear  
Doré / Gilded

## FINITION / FINISHING

## REFERENCE

## EAN CODE



CRISTAL INCOLORE - CLEAR CRYSTAL  
NICKEL - NICKEL

**EUROPE**  
10578700



CRISTAL INCOLORE - CLEAR CRYSTAL  
NICKEL - NICKEL

**US**  
10578800



CRISTAL INCOLORE - CLEAR CRYSTAL  
DORÉ - GILDED

**EUROPE**  
10578900



CRISTAL INCOLORE - CLEAR CRYSTAL  
DORÉ - GILDED

**US**  
10579000



E14 x 2

CE IP20

4100°K - Lumière neutre - Neutral light

2017 - LALIQUE ET DELISLE

Détails techniques et instructions de montage : cf fiche architecture. / Technical datas & mounting instructions: see architecture files.

# APPLIQUES - WALL SCONCES

## HÉLICONIA



Incolore / Clear  
Doré / Gilded

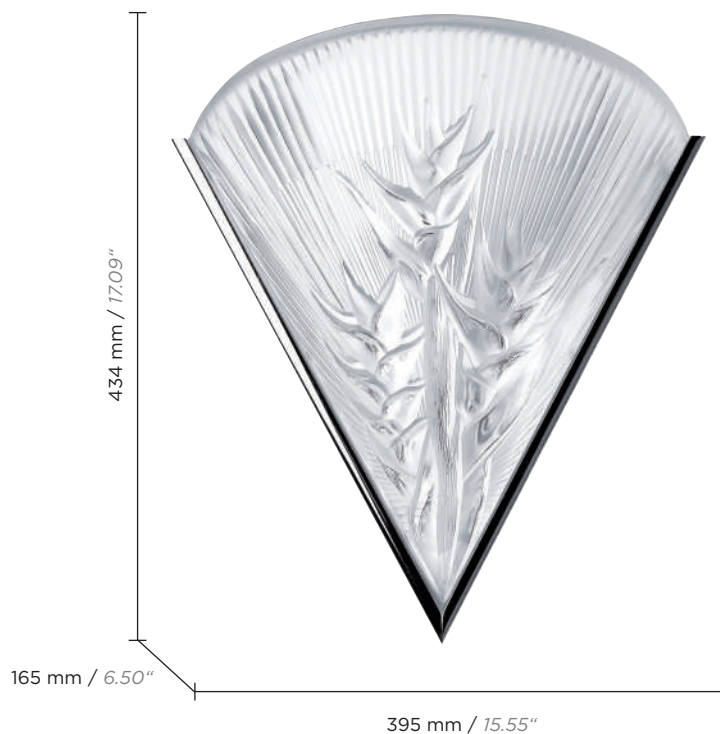

8,4 kg / 18.52 pounds

Incolore / Clear  
Chromé / Chrome

### FINITION / FINISHING

### REFERENCE

### EAN CODE



CRISTAL INCOLORE - CLEAR CRYSTAL  
CHROMÉ - CHROME

**EUROPE**  
1002100



CRISTAL INCOLORE - CLEAR CRYSTAL  
CHROMÉ - CHROME

**US**  
1002199



CRISTAL INCOLORE - CLEAR CRYSTAL  
DORÉ - GILDED

**EUROPE**  
1002200



CRISTAL INCOLORE - CLEAR CRYSTAL  
DORÉ - GILDED

**US**  
1002299



E14 x 1



**IP20**

2700°K - Lumière chaude - Warm light

1992 - Marie-Claude Lalique

Détails techniques et instructions de montage : cf fiche architecture. / Technical datas & mounting instructions: see architecture files.

# APPLIQUES - WALL SCONCES

## KORA CRISTALIGHT



403 mm / 15.87"

171 mm / 6.73"

106 mm / 4.17"

8,4 kg / 18.52 pounds

Incolore / Clear  
Chromé / Chrome



Incolore / Clear  
Doré / Gilded

### FINITION / FINISHING

### REFERENCE

### EAN CODE



CRISTAL INCOLORE - CLEAR CRYSTAL  
CHROMÉ - CHROME

**EUROPE**  
10177700



CRISTAL INCOLORE - CLEAR CRYSTAL  
CHROMÉ - CHROME

**US**  
10177800



CRISTAL INCOLORE - CLEAR CRYSTAL  
DORÉ - GILDED

**EUROPE**  
10177900



CRISTAL INCOLORE - CLEAR CRYSTAL  
DORÉ - GILDED

**US**  
10178000



BANDES / STRIPS LED x 3 - 12 watts - 520 lumens

CE IP20

4100°K - Lumière neutre - Neutral light

2011 - LALIQUE

Détails techniques et instructions de montage : cf fiche architecture. / Technical datas & mounting instructions: see architecture files.

# APPLIQUES - WALL SCONCES

## ORGUE

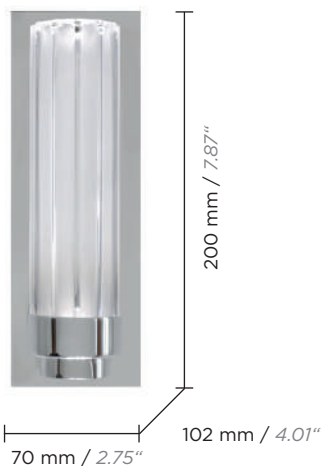

0,75 kg / 1.65 pounds

1 cristal / 1 crystal  
Incolore / Clear  
Chromé / Chrome

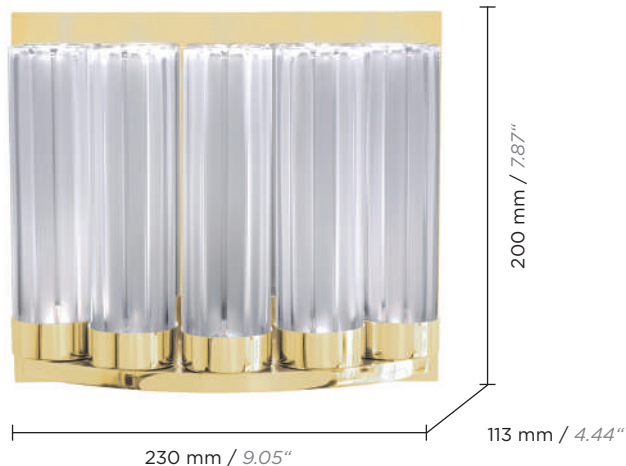

2,8 kg / 6.17 pounds

5 cristaux / 5 crystals  
Incolore / Clear  
Doré / Gilded

### FINITION / FINISHING

### REFERENCE

### EAN CODE



1 CRISTAL / 1 CRYSTAL



CRISTAL INCOLORE - CLEAR CRYSTAL  
CHROMÉ - CHROME

**EUROPE**  
10152900



CRISTAL INCOLORE - CLEAR CRYSTAL  
CHROMÉ - CHROME

**US**  
10157600



CRISTAL INCOLORE - CLEAR CRYSTAL  
DORÉ - GILDED

**EUROPE**  
10157700



CRISTAL INCOLORE - CLEAR CRYSTAL  
DORÉ - GILDED

**US**  
10157800



### 2011 - STUDIO ANDRÉE PUTMAN POUR LALIQUE



TRIO LED x 1 - 3 watts - 280 lumens



4100°K - Lumière neutre - Neutral light

Détails techniques et instructions de montage : cf fiche architecture. / Technical datas & mounting instructions: see architecture files.

### FINITION / FINISHING

### REFERENCE

### EAN CODE



5 CRISTAUX / 5 CRYSTALS



CRISTAL INCOLORE - CLEAR CRYSTAL  
CHROMÉ - CHROME

**EUROPE**  
10153000



CRISTAL INCOLORE - CLEAR CRYSTAL  
CHROMÉ - CHROME

**US**  
10157900



CRISTAL INCOLORE - CLEAR CRYSTAL  
DORÉ - GILDED

**EUROPE**  
10158000



CRISTAL INCOLORE - CLEAR CRYSTAL  
DORÉ - GILDED

**US**  
10158100



### 2011 - STUDIO ANDRÉE PUTMAN POUR LALIQUE



LED x 5 - 18 watts - 850 lumens



4100°K - Lumière neutre - Neutral light

Détails techniques et instructions de montage : cf fiche architecture. / Technical datas & mounting instructions: see architecture files.

# APPLIQUES - WALL SCONCES

PALME



2,1 kg / 4.63 pounds

Incolore / Clear  
Chromé / Chrome



Incolore / Clear  
Doré / Gilded

FINITION / FINISHING

REFERENCE

EAN CODE



CRISTAL INCOLORE - CLEAR CRYSTAL  
CHROMÉ - CHROME

**EUROPE**  
1000800



CRISTAL INCOLORE - CLEAR CRYSTAL  
CHROMÉ - CHROME

**US**  
1000899



CRISTAL INCOLORE - CLEAR CRYSTAL  
DORÉ - GILDED

**EUROPE**  
1004000



CRISTAL INCOLORE - CLEAR CRYSTAL  
DORÉ - GILDED

**US**  
1004099



E14 x 1

CE IP20

2700°K - Lumière chaude - Warm light

1947 - Marc Lalique

Détails techniques et instructions de montage : cf fiche architecture. / Technical datas & mounting instructions: see architecture files.

# APPLIQUES - WALL SCONCES

## SERENE

### PRISME DOUBLE / DOUBLE PRISM

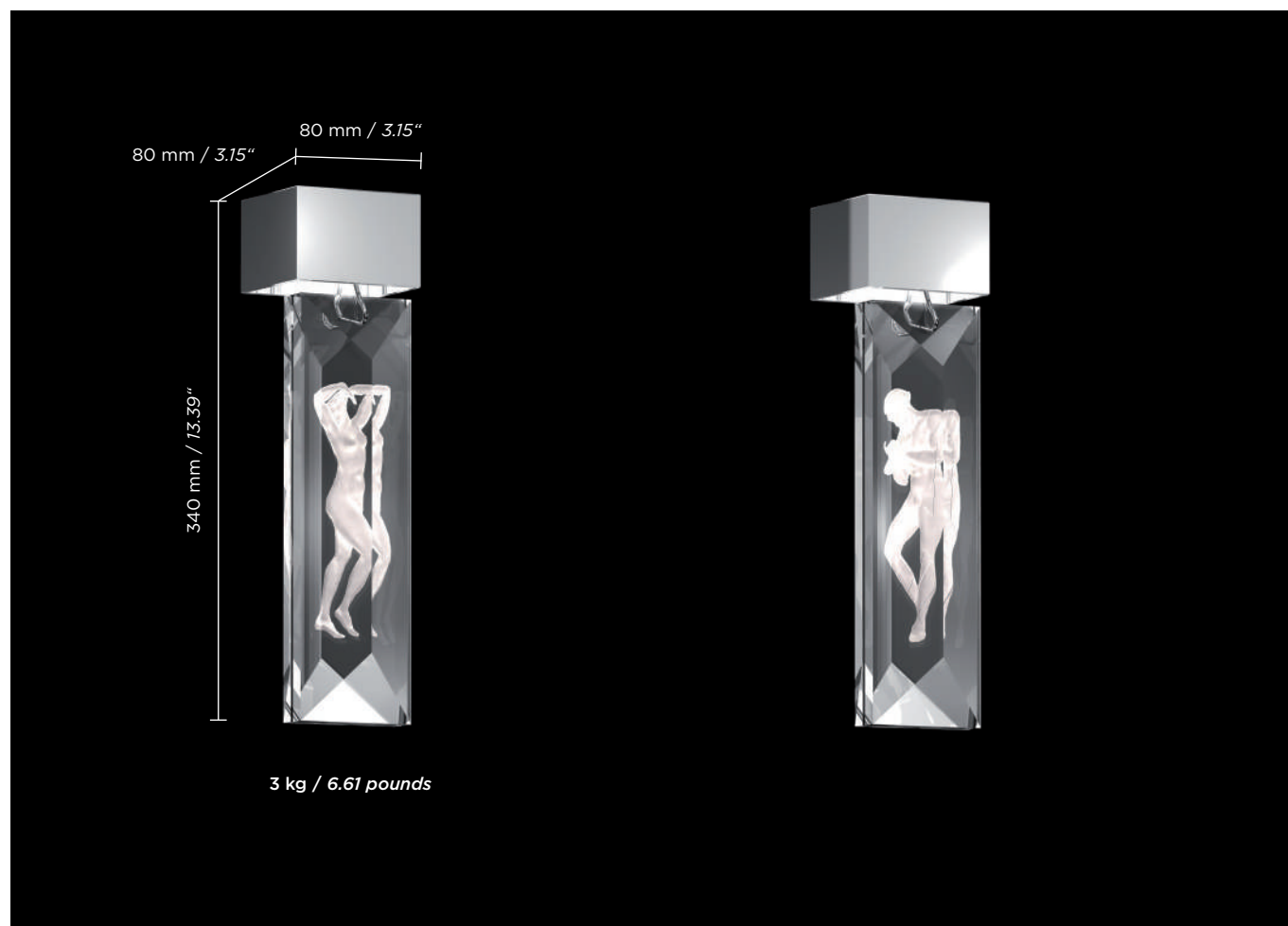

FINITION / FINISHING	REFERENCE	EAN CODE
<b>DAHLIA</b>  CRISTAL INCOLORE CLEAR CRYSTAL	10434800	0 90592 91583 7
<b>FIGURINES</b>  CRISTAL INCOLORE CLEAR CRYSTAL	10434700	0 90592 91584 4



3 finitions de montage disponibles. Merci de préciser la finition souhaitée lors de la commande.  
3 available mounting finishing. Please specify the desired finishing when ordering.

 LED G4 - 1,5 watts - 90 lumens **CE IP30** 2700°K - Lumière chaude - Warm light Luminaire non gradable. / Non dimmable lighting.

#### 2014 - WINDFALL & LALIQUE

Détails techniques et instructions de montage : cf fiche architecture. / Technical datas & mounting instructions: see architecture files.  
Hauteur réglable. Pas de drop minimum. / Height adjustable. No minimum drop.

Compositions de cristal et finitions métal réalisables sur mesure. / Bespoke crystal and metal finishing customized choice available upon request.

# APPLIQUES - WALL SCONCES

## SERENE 4 PRISMES / 4 PRISMS

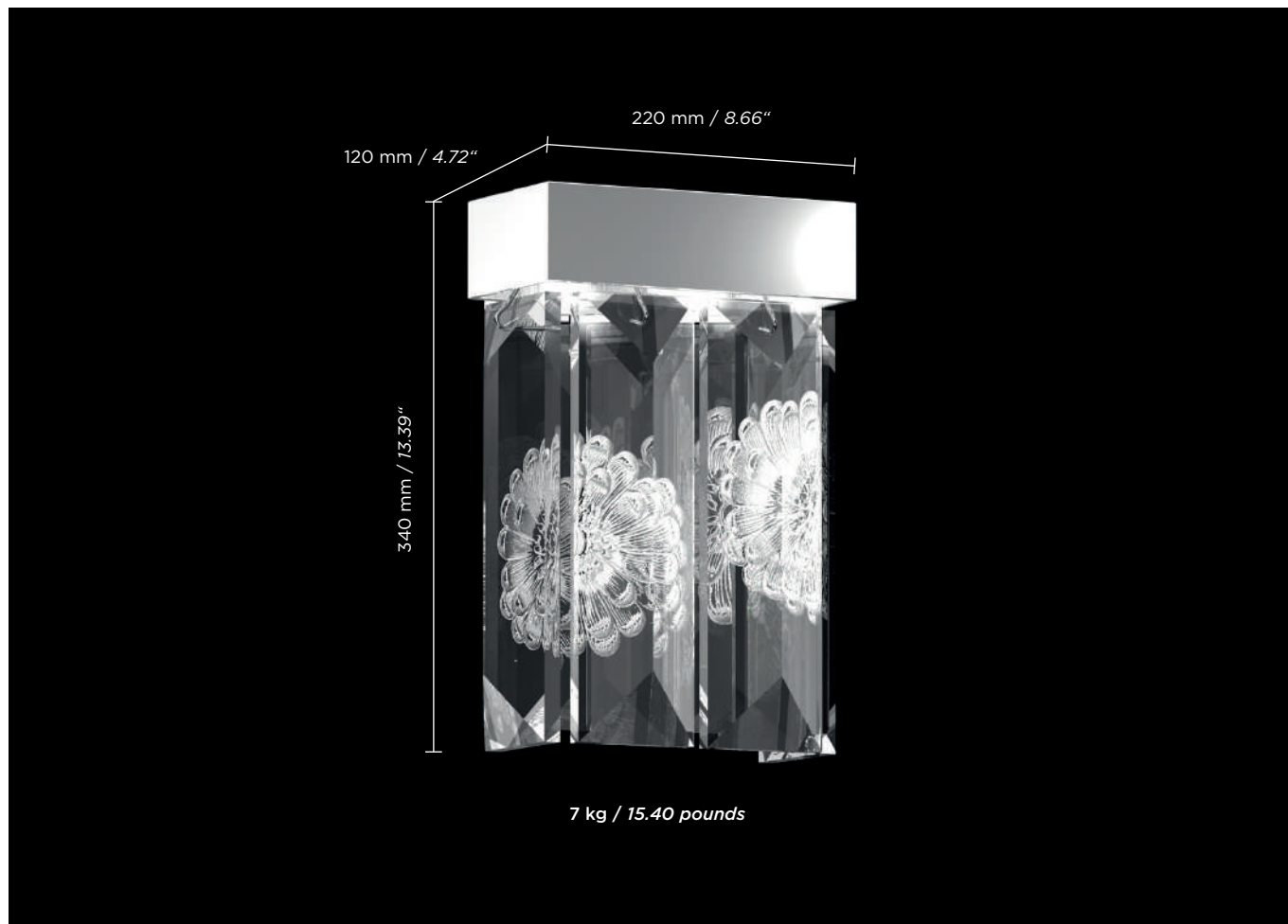

FINITION / FINISHING	REFERENCE	EAN CODE
<b>DAHLIA</b>  CRISTAL INCOLORE CLEAR CRYSTAL	10435000	0 90592 91581 3
<b>FIGURINES</b>  CRISTAL INCOLORE CLEAR CRYSTAL	10434900	0 90592 91582 0



3 finitions de monture disponibles. Merci de préciser la finition souhaitée lors de la commande.  
3 available mounting finishing. Please specify the desired finishing when ordering.



LED G4 - 4,5 watts - 270 lumens

CE IP30

2700°K - Lumière chaude - Warm light

Luminaire non gradable. / Non dimmable lighting.

### 2014 - WINDFALL & LALIQUE

Détails techniques et instructions de montage : cf fiche architecture. / Technical datas & mounting instructions: see architecture files.

Hauteur réglable. Pas de drop minimum. / Height adjustable. No minimum drop.

Compositions de cristal et finitions métal réalisables sur mesure. / Bespoke crystal and metal finishing customized choice available upon request.





# APPLIQUES - WALL SCONCES

## SERENE

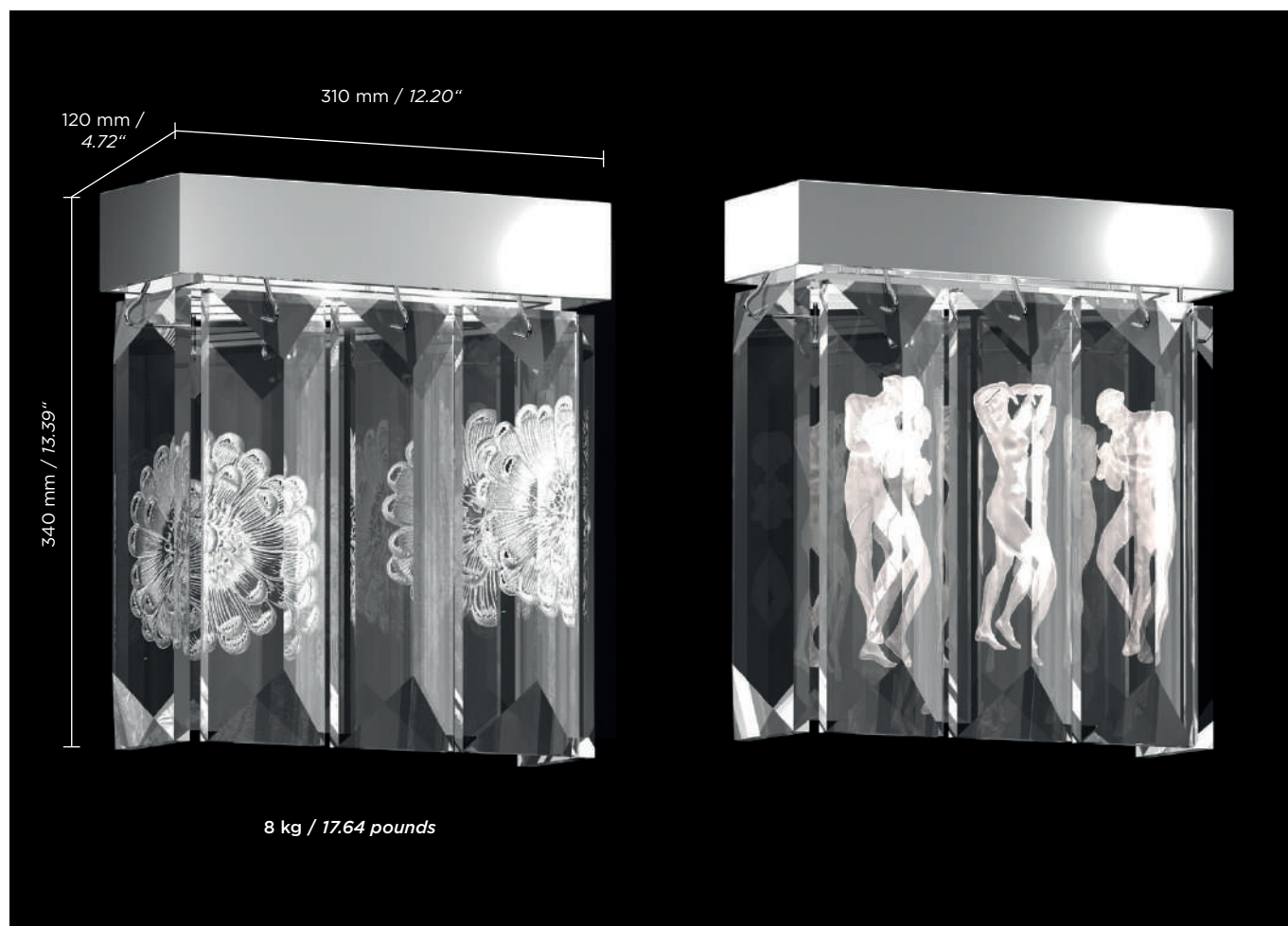

5 PRISMES, RECTANGULAIRE / 5 PRISMS, RECTANGULAR



FINITION / FINISHING	REFERENCE	EAN CODE
<b>DAHLIA</b>  CRISTAL INCOLORE CLEAR CRYSTAL	10435200	0 90592 91579 0
<b>FIGURINES</b>  CRISTAL INCOLORE CLEAR CRYSTAL	10435100	0 90592 91580 6



3 finitions de montage disponibles. Merci de préciser la finition souhaitée lors de la commande.  
 3 available mounting finishing. Please specify the desired finishing when ordering.

 LED G4 - 6 watts - 360 lumens   
  **IP30**   
 2700°K - Lumière chaude - Warm light   
 Luminaire non gradable. / Non dimmable lighting.

### 2014 - WINDFALL & LALIQUE

Détails techniques et instructions de montage : cf fiche architecture. / Technical datas & mounting instructions: see architecture files.  
 Hauteur réglable. Pas de drop minimum. / Height adjustable. No minimum drop.

Compositions de cristal et finitions métal réalisables sur mesure. / Bespoke crystal and metal finishing customized choice available upon request.

# APPLIQUES - WALL SCONCES

SERENE

5 PRISMES, CIRCULAIRE / 5 PRISMS, CIRCULAR

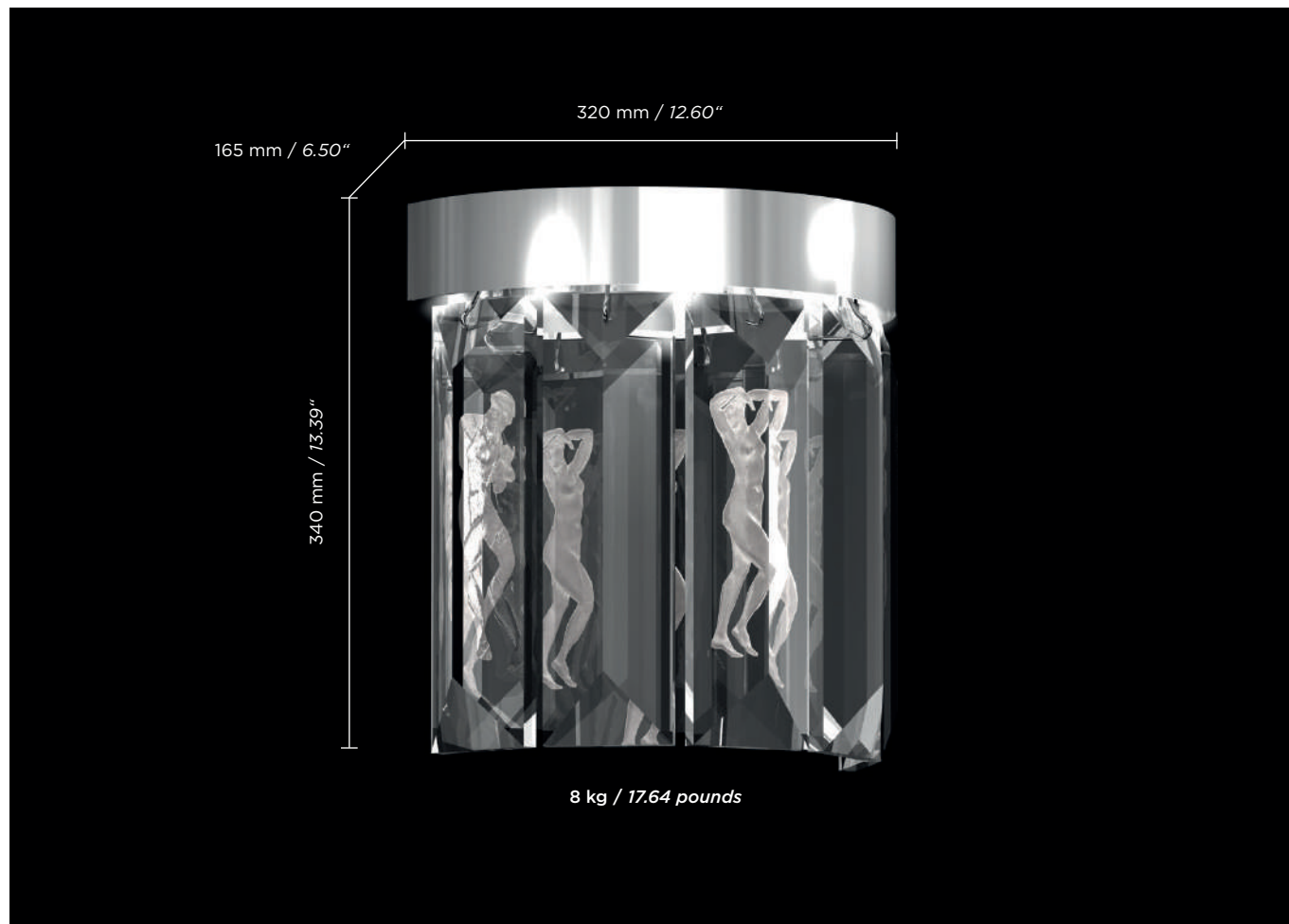

FINITION / FINISHING	REFERENCE	EAN CODE
<b>DAHLIA</b>  CRISTAL INCOLORE CLEAR CRYSTAL	10435400	0 90592 91577 6
<b>FIGURINES</b>  CRISTAL INCOLORE CLEAR CRYSTAL	10435300	0 90592 91578 3



Bronze / Bronze



Nickel (plaqué) / Nickel (plated)



Or (plaqué) / Gold (plated)

3 finitions de monture disponibles. Merci de préciser la finition souhaitée lors de la commande.  
3 available mounting finishing. Please specify the desired finishing when ordering.



LED G4 - 6 watts - 360 lumens

CE IP30

2700°K - Lumière chaude - Warm light

Luminaire non gradable. / Non dimmable lighting.

## 2014 - WINDFALL & LALIQUE

Détails techniques et instructions de montage : cf fiche architecture. / Technical datas & mounting instructions: see architecture files.  
Hauteur réglable. Pas de drop minimum. / Height adjustable. No minimum drop.



Compositions de cristal et finitions métal réalisables sur mesure. / Bespoke crystal and metal finishing customized choice available upon request.

# APPLIQUES - WALL SCONCES

## SERENE

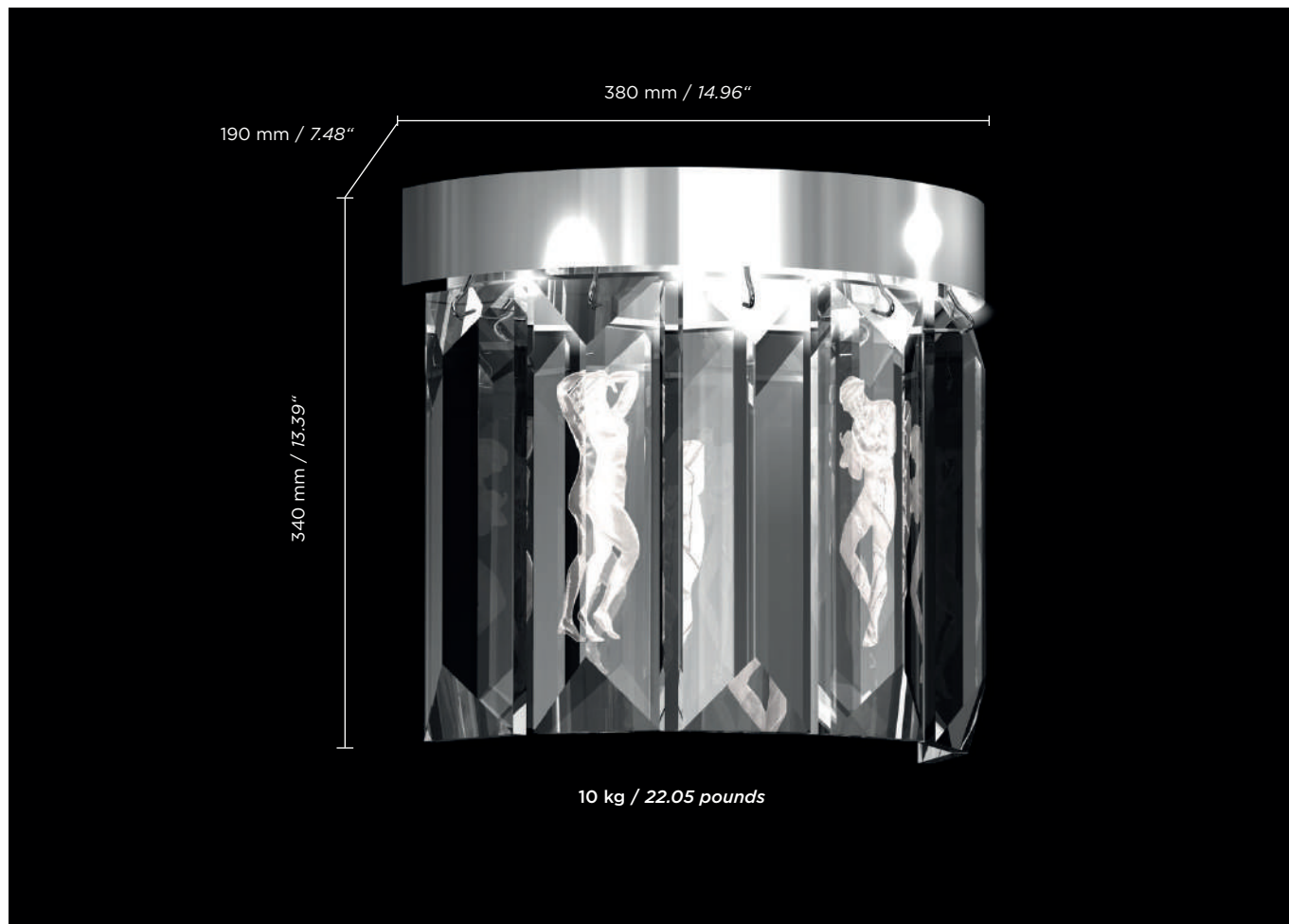
6 PRISMES, CIRCULAIRE / 6 PRISMS, CIRCULAR



FINITION / FINISHING	REFERENCE	EAN CODE
<b>DAHLIA</b>  CRISTAL INCOLORE CLEAR CRYSTAL	10435600	0 90592 91575 2
<b>FIGURINES</b>  CRISTAL INCOLORE CLEAR CRYSTAL	10435500	0 90592 91576 9



3 finitions de monture disponibles. Merci de préciser la finition souhaitée lors de la commande.  
3 available mounting finishing. Please specify the desired finishing when ordering.



LED G4 - 7,5 watts - 450 lumens

CE IP30

2700°K - Lumière chaude - Warm light

Luminaire non gradable. / Non dimmable lighting.

### 2014 - WINDFALL & LALIQUE

Détails techniques et instructions de montage : cf fiche architecture. / Technical datas & mounting instructions: see architecture files.  
Hauteur réglable. Pas de drop minimum. / Height adjustable. No minimum drop.

Compositions de cristal et finitions métal réalisables sur mesure. / Bespoke crystal and metal finishing customized choice available upon request.

# APPLIQUES - WALL SCONCES

## SÉVILLE 1 RANG / 1 TIER



Incolore / Clear  
Chromé / Chrome



Incolore et noir / Clear and black  
Chromé / Chrome



Incolore / Clear  
Doré / Gilded

### FINITION / FINISHING



CRISTAL INCOLORE - CLEAR CRYSTAL  
CHROMÉ - CHROME

### REFERENCE

**EUROPE**  
1000200

### EAN CODE



CRISTAL INCOLORE - CLEAR CRYSTAL  
CHROMÉ - CHROME

**US**  
1000299



CRISTAL INCOLORE - CLEAR CRYSTAL  
DORÉ - GILDED

**EUROPE**  
1001600



CRISTAL INCOLORE - CLEAR CRYSTAL  
DORÉ - GILDED

**US**  
1001699



1947 - Marc Lalique



CRISTAL INCOLORE ET NOIR - CLEAR AND BLACK CRYSTAL  
CHROMÉ - CHROME

**EUROPE**  
1000500



CRISTAL INCOLORE ET NOIR - CLEAR AND BLACK CRYSTAL  
CHROMÉ - CHROME

**US**  
1000599



2007 - LALIQUE



E14 x1

CE IP20

2700°K - Lumière chaude - Warm light

Détails techniques et instructions de montage : cf fiche architecture. / Technical datas & mounting instructions: see architecture files.

COUTARD



463 mm / 18.23"

Ø 125 mm / 4.92"

3,30 kg / 7.28 pounds

FINITION / FINISHING



CRISTAL INCOLORE - CLEAR CRYSTAL  
CHROMÉ - CHROME

REFERENCE

**EUROPE**  
10552400

EAN CODE



CRISTAL INCOLORE - CLEAR CRYSTAL  
CHROMÉ - CHROME

**US**  
10552500



LED 28 - 9 watts - 730 lumens



2700°K - Lumière chaude - Warm light à / to 4100°K - Lumière neutre - Neutral light

2017 - LALIQUE

Détails techniques et instructions de montage : cf fiche architecture. / Technical datas & mounting instructions: see architecture files.



630 mm / 24.80"

Ø 200 mm / 7.87"  
5,79 kg / 12.76 pounds

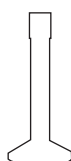

**LAMPE HORS ABAT-JOUR**  
Hauteur x Diamètre - Poids :  
500 x 200 mm - 5,4 kg  
**LAMP WITHOUT LAMPSHADE**  
Height x Diameter - Weight:  
19.69" x 7.87" - 11.90 pounds

FINITION / FINISHING



CRISTAL INCOLORE - CLEAR CRYSTAL  
CHROMÉ - CHROME

REFERENCE

**EUROPE**  
1150000

EAN CODE



CRISTAL INCOLORE - CLEAR CRYSTAL  
CHROMÉ - CHROME

**US**  
1150099



E27 x 1

**CE IP20**

2700°K - Lumière chaude - Warm light

Lampe livrée sans abat-jour. / Lamp delivered without lampshade.

1997 - LALIQUE

Détails techniques et instructions de montage : cf fiche architecture. / Technical datas & mounting instructions: see architecture files.



**ABAT-JOUR CYLINDRIQUE**  
Hauteur x Diamètre - Poids :  
210 mm x 470 mm - 0,39 kg  
**LAMPSHADE CYLINDRICAL**  
Height x Diameter - Weight:  
8.27" x 18.50" - 0.86 pounds

FINITION / FINISHING



CRÈME / INTÉRIEUR BLANC  
CREAM / INSIDE WHITE

REFERENCE

10031700

EAN CODE



NOIR / INTÉRIEUR ARGENT  
BLACK / INSIDE SILVER

10059600



2008 - LALIQUE

# LAMPES - LAMPS

## GINKGO



Incolore / Clear  
Doré / Gilded



4 kg / 8.82 pounds

Incolore / Clear  
Chromé / Chrome

### FINITION / FINISHING



CRISTAL INCOLORE - CLEAR CRYSTAL  
NICKEL - NICKEL

### REFERENCE

**EUROPE**  
10579100

### EAN CODE



CRISTAL INCOLORE - CLEAR CRYSTAL  
NICKEL - NICKEL

**US**  
10579200



CRISTAL INCOLORE - CLEAR CRYSTAL  
DORÉ - GILDED

**EUROPE**  
10579300



CRISTAL INCOLORE - CLEAR CRYSTAL  
DORÉ - GILDED

**US**  
10579400



E14 x 2 - 520 lumens

CE IP20 4000°K - Lumière neutre - Neutral light

### 2017 - LALIQUE & DELISLE

Détails techniques et instructions de montage : cf fiche architecture. / Technical datas & mounting instructions: see architecture files.



FINITION / FINISHING



CRISTAL INCOLORE - CLEAR CRYSTAL  
CHROMÉ - CHROME

REFERENCE

**EUROPE**  
10648800

EAN CODE



CRISTAL INCOLORE - CLEAR CRYSTAL  
CHROMÉ - CHROME

**US**  
10648900



CRISTAL BLEU SAPHIR - SAPPHIRE BLUE CRYSTAL  
CHROMÉ - CHROME

**EUROPE**  
10649000



CRISTAL BLEU SAPHIR - SAPPHIRE BLUE CRYSTAL  
CHROMÉ - CHROME

**US**  
10649100



1 LED **CE** IP20

2700°K - Lumière chaude - Warm light

2018 - LALIQUE

Détails techniques : cf fiche d'indentité. / Technical datas : see indentité file files.



MASQUE DE FEMME



FINITION / FINISHING



CRISTAL INCOLORE - CLEAR CRYSTAL  
CHROMÉ - CHROME



CRISTAL INCOLORE - CLEAR CRYSTAL  
CHROMÉ - CHROME

REFERENCE

**EUROPE**  
10552000

**US**  
10552100

EAN CODE



BANDES LED - 16 watts - 580 lumens

**CE IP20**

2700°K - Lumière chaude - Warm light à / to 4100°K - Lumière neutre - Neutral light

2017 - LALIQUE

Détails techniques et instructions de montage : cf fiche architecture. / Technical datas & mounting instructions: see architecture files.

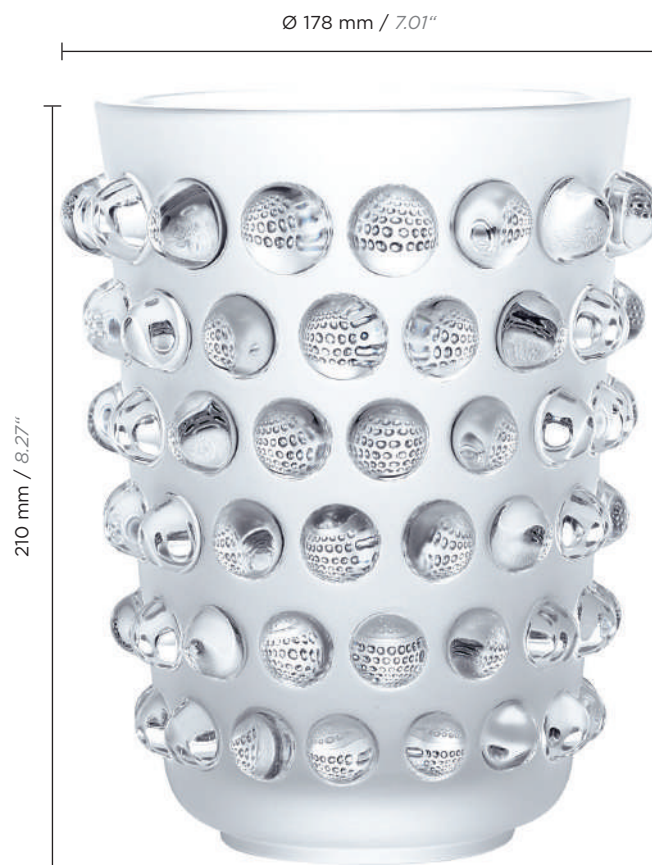

3,7 kg / 8.16 pounds

FINITION / FINISHING



CRISTAL INCOLORE  
CLEAR CRYSTAL

CRISTAL INCOLORE  
CLEAR CRYSTAL

REFERENCE

**EUROPE**  
1150900

**US**  
1150999

EAN CODE



E14 x 1

**CE IP20**

2700°K - Lumière chaude - Warm light

2005 - LALIQUE

Détails techniques et instructions de montage : cf fiche architecture. / Technical datas & mounting instructions: see architecture files.

# LAMPES - LAMPS

## POSÉIDON

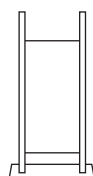

### LAMPE HORS ABAT-JOUR

Hauteur x Longueur x Largeur - Poids :  
430 x 200 x 120 mm - 2,85 kg

### LAMP WITHOUT LAMPSHADE

Height x Length x Width - Weight:  
16.93" x 7.87" x 4.72" - 6.28 pounds

200 mm / 7.87"

3,27 kg / 7.21 pounds

### FINITION / FINISHING



CRISTAL INCOLORE - CLEAR CRYSTAL  
CHROMÉ - CHROME



CRISTAL INCOLORE - CLEAR CRYSTAL  
CHROMÉ - CHROME

### REFERENCE

**EUROPE**  
1150800

**US**  
1150899

### EAN CODE



E27 x 1

CE IP20

2700°K - Lumière chaude - Warm light

Lampe livrée sans abat-jour. / Lamp delivered without lampshade.

2004 - LALIQUE

Détails techniques et instructions de montage : cf fiche architecture. / Technical datas & mounting instructions: see architecture files.



### ABAT-JOUR

Hauteur x Longueur x Largeur - Poids :  
140 x 370 x 120 mm - 0,42 kg

### LAMPSHADE

Height x Length x Width - Weight:  
5.51" x 14.57" x 4.72" - 0.93 pounds

### FINITION / FINISHING



PERCALINE CRÈME / INTÉRIEUR ARGENT  
CREAM PERCALINE COTTON / INSIDE SILVER



PERCALINE NOIRE / INTÉRIEUR ARGENT  
BLACK PERCALINE COTTON / INSIDE SILVER

### REFERENCE

0150850

0150840

### EAN CODE



2007 - LALIQUE

## SERENE 6 PRISMES, CIRCULAIRE / 6 PRISMS, CIRCULAR

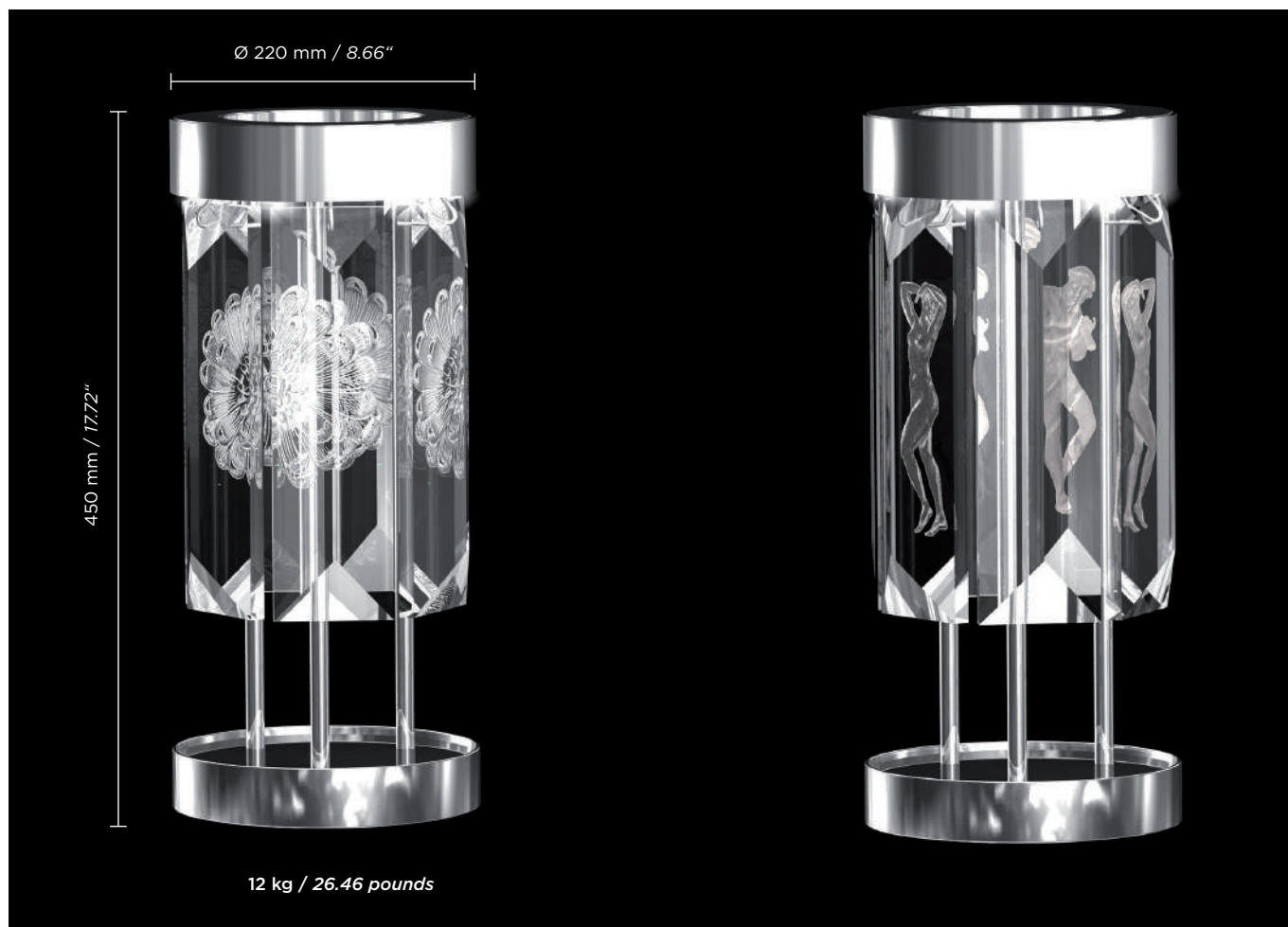

FINITION / FINISHING		REFERENCE	EAN CODE
<b>DAHLIA</b>	 CRISTAL INCOLORE CLEAR CRYSTAL	10432200	 0 90592 91610 0
<b>FIGURINES</b>	 CRISTAL INCOLORE CLEAR CRYSTAL	10432300	 0 90592 91559 2



Bronze / Bronze



Nickel (plaqué) / Nickel (plated)



Or (plaqué) / Gold (plated)

3 finitions de monture disponibles. Merci de préciser la finition souhaitée lors de la commande.  
3 available mounting finishing. Please specify the desired finishing when ordering.



LED G4 - 9 watts - 540 lumens

CE IP30 2700°K - Lumière chaude - Warm light

Luminaire non gradable. / Non dimmable lighting.

### 2014 - WINDFALL & LALIQUE

Détails techniques et instructions de montage : cf fiche architecture. / Technical datas & mounting instructions: see architecture files.  
Hauteur réglable. Pas de drop minimum. / Height adjustable. No minimum drop.

Compositions de cristal et finitions métal réalisables sur mesure. / Bespoke crystal and metal finishing customized choice available upon request.

## VERSAILLES



9,91 kg / 21.84 pounds



### LAMPE HORS ABAT-JOUR

Hauteur x Largeur - Poids :  
450 x 230 mm - 9,4 kg

### LAMP WITHOUT LAMPSHADE

Height x Width - Weight:  
17.72" x 9.06" - 20.72 pounds

#### FINITION / FINISHING



CRISTAL INCOLORE - CLEAR CRYSTAL  
CHROMÉ - CHROME

#### REFERENCE

**EUROPE**  
1153800

#### EAN CODE



CRISTAL INCOLORE - CLEAR CRYSTAL  
CHROMÉ - CHROME

**US**  
1153899



E27 x 1

**CE IP20**

2700°K - Lumière chaude - Warm light

Lampe livrée sans abat-jour. / Lamp delivered without lampshade.

2006 - LALIQUE

Détails techniques et instructions de montage : cf fiche architecture. / Technical datas & mounting instructions: see architecture files.



### ABAT-JOUR

Hauteur x Diamètre - Poids :  
320 x 450 mm - 0,51 kg

### LAMPSHADE

Height x Diameter - Weight:  
12.60" x 17.72" - 1.12 pounds

#### FINITION / FINISHING

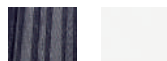

MOUSSELINE NOIRE / INTÉRIEUR BLANC  
BLACK MUSLIN / INSIDE WHITE

#### REFERENCE

0153800

#### EAN CODE



2006 - LALIQUE

# LANTERNES - LANTERNS

COUTARD  
PM / SS

ÉDITION NUMÉROTÉE / NUMBERED EDITION



514 mm / 20.24"

Drop mini : 860 mm / 33.86"

Ø 480 mm / 18.90"

40 kg / 88.18 pounds

Incolore / Clear  
Noir mat / Matte black



514 mm / 20.24"

Drop mini : 860 mm / 33.86"

Ø 480 mm / 18.90"

40 kg / 88.18 pounds

Incolore / Clear  
Doré satiné / Satin gilded

## FINITION / FINISHING

## REFERENCE

## EAN CODE



CRISTAL INCOLORE - CLEAR CRYSTAL  
NICKEL - NICKEL

**EUROPE**  
10642700



CRISTAL INCOLORE - CLEAR CRYSTAL  
NICKEL - NICKEL

**US**  
10642800



CRISTAL INCOLORE - CLEAR CRYSTAL  
NOIR MAT - MATTE BLACK

**EUROPE**  
10642900



CRISTAL INCOLORE - CLEAR CRYSTAL  
NOIR MAT - MATTE BLACK

**US**  
10643000



CRISTAL INCOLORE - CLEAR CRYSTAL  
DORÉ SATINÉ - SATIN GILDED

**EUROPE**  
10643100



CRISTAL INCOLORE - CLEAR CRYSTAL  
DORÉ SATINÉ - SATIN GILDED

**US**  
10643200



Bande LED - LED stripe - 100 watts

CE IP20

2700°K - Lumière chaude - Warm light

## 2018 - PIERRE-YVES ROCHON POUR LALIQUE

Détails techniques et instructions de montage : cf fiche architecture. / Technical datas & mounting instructions: see architecture files.

Préciser la hauteur totale du lustre à la commande. / Precise the total height of the chandelier when ordering.

Éclairage gradable avec télécommande ou domotique (sur demande). / Dimmable lighting with remote control or home automation (bespoke order).

# LANTERNES - LANTERNS

COUTARD

GM / LS

ÉDITION NUMÉROTÉE / NUMBERED EDITION



Ø 750 mm / 29.53"  
90 kg / 198.42 pounds

Incolore / Clear  
Chromé / Chrome

FINITION / FINISHING	REFERENCE	EAN CODE
 CRISTAL INCOLORE - CLEAR CRYSTAL NICKEL - NICKEL	<b>EUROPE</b> 10642300	
 CRISTAL INCOLORE - CLEAR CRYSTAL NICKEL - NICKEL	<b>US</b> 10642400	
 CRISTAL INCOLORE - CLEAR CRYSTAL NOIR MAT - MATTE BLACK	<b>EUROPE</b> 10642500	
 CRISTAL INCOLORE - CLEAR CRYSTAL NOIR MAT - MATTE BLACK	<b>US</b> 10642600	
 CRISTAL INCOLORE - CLEAR CRYSTAL DORÉ SATINÉ - SATIN GILDED	<b>EUROPE</b> 10656700	
 CRISTAL INCOLORE - CLEAR CRYSTAL DORÉ SATINÉ - SATIN GILDED	<b>US</b> 10656800	



Bande LED - LED stripe - 185 watts

CE IP20

2700°K - Lumière chaude - Warm light

## 2018 - PIERRE-YVES ROCHON POUR LALIQUE

Détails techniques et instructions de montage : cf fiche architecture. / Technical datas & mounting instructions: see architecture files.

Préciser la hauteur totale du lustre à la commande. / Precise the total height of the chandelier when ordering.

Éclairage gradable avec télécommande ou domotique (sur demande). / Dimmable lighting with remote control or home automation (bespoke order).

# LANTERNE - LANTERN

GINKGO



Incolore / Clear  
Doré / Gilded



Incolore / Clear  
Chromé / Chrome

830 mm / 32.68"

Drop mini : 990 mm / 38.98"

Ø 410 mm / 16.14"

21 kg / 46.30 pounds

## FINITION / FINISHING



CRISTAL INCOLORE - CLEAR CRYSTAL  
NICKEL - NICKEL

## REFERENCE

**EUROPE**  
10579500

## EAN CODE



CRISTAL INCOLORE - CLEAR CRYSTAL  
NICKEL - NICKEL

**US**  
10579600



CRISTAL INCOLORE - CLEAR CRYSTAL  
DORÉ - GILDED

**EUROPE**  
10579700



CRISTAL INCOLORE - CLEAR CRYSTAL  
DORÉ - GILDED

**US**  
10579800



E27 x 3 - 6 watts - 520 lumens

CE IP20

4000°K - Lumière neutre - Neutral light

## 2017 - LALIQUE & DELISLE

Détails techniques et instructions de montage : cf fiche architecture. / Technical datas & mounting instructions: see architecture files.



# LUSTRES - CHANDELIERS

## CHAMPS-ÉLYSÉES 1 RANG / 1 TIER



Lustré or / Gold luster  
Doré / Gilded



Ø 560 mm / 22.05"

19,5 kg / 42.99 pounds

Incolore / Clear  
Chromé / Chrome



Incolore / Clear  
Doré / Gilded

### FINITION / FINISHING



CRISTAL INCOLORE - CLEAR CRYSTAL  
CHROMÉ - CHROME

### REFERENCE

**EUROPE**  
1011294

### EAN CODE



CRISTAL INCOLORE - CLEAR CRYSTAL  
CHROMÉ - CHROME

**US**  
1011297



CRISTAL INCOLORE - CLEAR CRYSTAL  
DORÉ - GILDED

**EUROPE**  
1011494



CRISTAL INCOLORE - CLEAR CRYSTAL  
DORÉ - GILDED

**US**  
1011497



### 2001 - LALIQUE



CRISTAL LUSTRÉ OR - GOLD LUSTER CRYSTAL  
DORÉ - GILDED

**EUROPE**  
10544800



CRISTAL LUSTRÉ OR - GOLD LUSTER CRYSTAL  
DORÉ - GILDED

**US**  
10544900



### 2016 - LALIQUE



E14 x 6

CE IP20

2700°K - Lumière chaude - Warm light

Détails techniques et instructions de montage : cf fiche architecture. / Technical datas & mounting instructions: see architecture files.  
Préciser la hauteur totale du lustre à la commande (minimum 330 mm). / Precise the total height of the chandelier when ordering (12.99 inches minimum).

# LUSTRES - CHANDELIERS

## CHAMPS-ÉLYSÉES 2 RANGS / 2 TIERS

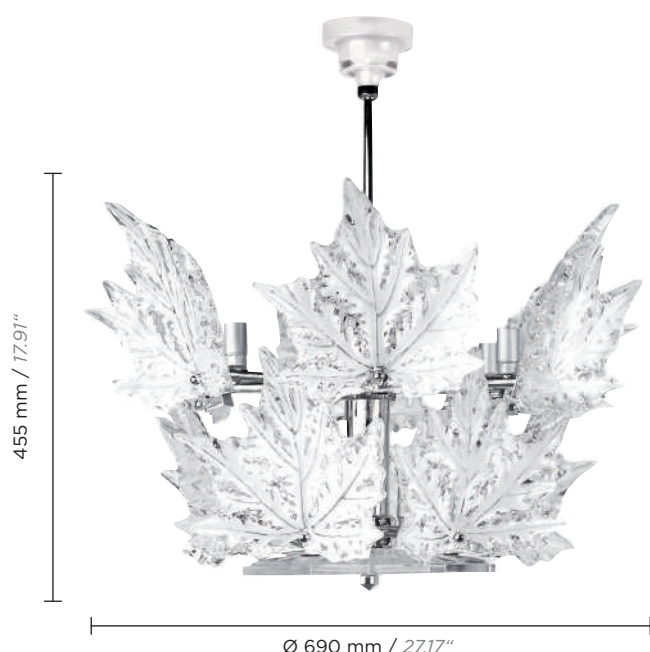

38 kg / 83.78 pounds

Incolore / Clear  
Chromé / Chrome



Lustré or / Gold luster  
Doré / Gilded

### FINITION / FINISHING



CRISTAL INCOLORE - CLEAR CRYSTAL  
CHROMÉ - CHROME

### REFERENCE

**EUROPE**  
1011394

### EAN CODE



CRISTAL INCOLORE - CLEAR CRYSTAL  
CHROMÉ - CHROME

**US**  
1011397



CRISTAL INCOLORE - CLEAR CRYSTAL  
DORÉ - GILDED

**EUROPE**  
1011594



CRISTAL INCOLORE - CLEAR CRYSTAL  
DORÉ - GILDED

**US**  
1011597



### 2001 - LALIQUE



CRISTAL LUSTRÉ OR - GOLD LUSTER CRYSTAL  
DORÉ - GILDED

**EUROPE**  
10545000



CRISTAL LUSTRÉ OR - GOLD LUSTER CRYSTAL  
DORÉ - GILDED

**US**  
10545100



### 2016 - LALIQUE



E14 x 12

CE IP20

2700°K - Lumière chaude - Warm light

Détails techniques et instructions de montage : cf fiche architecture. / Technical datas & mounting instructions: see architecture files.

Préciser la hauteur totale du lustre à la commande (minimum 510 mm). / Precise the total height of the chandelier when ordering (20.08 inches minimum)

# LUSTRES - CHANDELIERS

## CHAMPS-ÉLYSÉES 3 RANGS / 3 TIERS

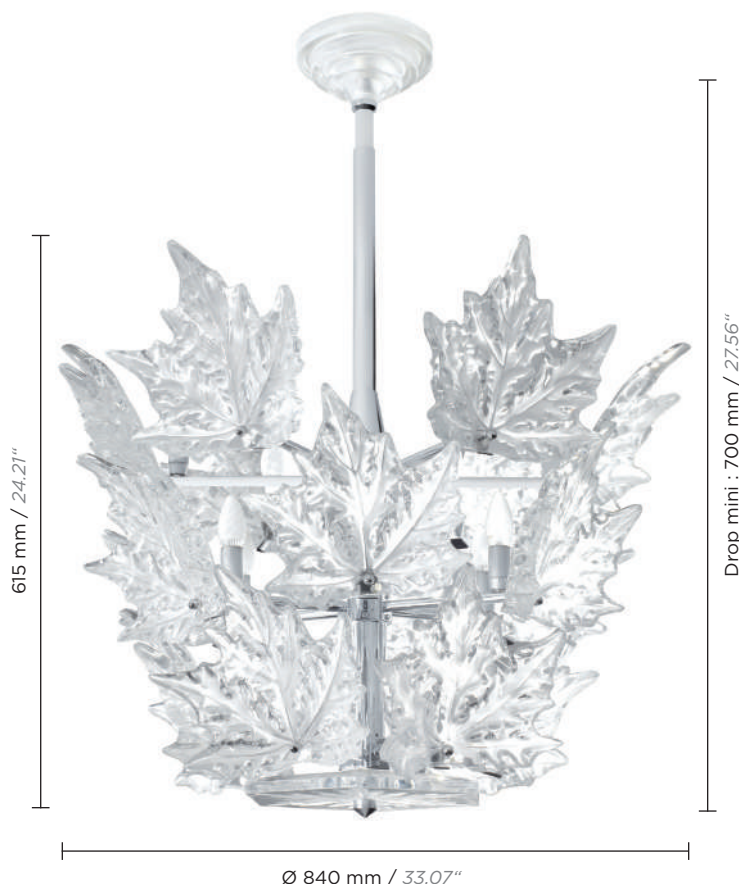

55 kg / 121.25 pounds

Incolore / Clear  
Chromé / Chrome



Lustré or / Gold luster  
Doré / Gilded

### FINITION / FINISHING



CRISTAL INCOLORE - CLEAR CRYSTAL  
CHROMÉ - CHROME

### REFERENCE

**EUROPE**  
1012100

### EAN CODE



CRISTAL INCOLORE - CLEAR CRYSTAL  
CHROMÉ - CHROME

**US**  
1012199



1957 - Marc Lalique



CRISTAL INCOLORE - CLEAR CRYSTAL  
DORÉ - GILDED

**EUROPE**  
1012200



CRISTAL INCOLORE - CLEAR CRYSTAL  
DORÉ - GILDED

**US**  
1012299



1993 - LALIQUE



CRISTAL LUSTRÉ OR - GOLD LUSTER CRYSTAL  
DORÉ - GILDED

**EUROPE**  
10545200



CRISTAL LUSTRÉ OR - GOLD LUSTER CRYSTAL  
DORÉ - GILDED

**US**  
10545300



2016 - LALIQUE



E14 x 18

CE IP20

2700°K - Lumière chaude - Warm light

Détails techniques et instructions de montage : cf fiche architecture. / Technical datas & mounting instructions: see architecture files.

Préciser la hauteur totale du lustre à la commande (minimum 700 mm). / Precise the total height of the chandelier when ordering (27.56 inches minimum).

# LUSTRES - CHANDELIERS

## CHAMPS-ÉLYSÉES 5 RANGS / 5 TIERS



90 kg / 198.42 pounds

Incolore / Clear  
Chromé / Chrome



Lustré or / Gold luster  
Doré / Gilded

FINITION / FINISHING	REFERENCE	EAN CODE
 CRISTAL INCOLORE - CLEAR CRYSTAL CHROMÉ - CHROME	<b>EUROPE</b> 10619000	 0 90592 89609 9
 CRISTAL INCOLORE - CLEAR CRYSTAL CHROMÉ - CHROME	<b>US</b> 10619100	 0 90592 89608 2
 CRISTAL INCOLORE - CLEAR CRYSTAL DORÉ - GILDED	<b>EUROPE</b> 10619200	 0 90592 89607 5
 CRISTAL INCOLORE - CLEAR CRYSTAL DORÉ - GILDED	<b>US</b> 10619300	 0 90592 89606 8
 CRISTAL LUSTRÉ OR - GOLD LUSTER CRYSTAL DORÉ - GILDED	<b>EUROPE</b> 10619400	 0 90592 89605 1
 CRISTAL LUSTRÉ OR - GOLD LUSTER CRYSTAL DORÉ - GILDED	<b>US</b> 10619500	 0 90592 89604 4



E14 x 30

CE IP20

2700°K - Lumière chaude - Warm light

2017 - LALIQUE

Détails techniques et instructions de montage : cf fiche architecture. / Technical datas & mounting instructions: see architecture files.

Préciser la hauteur totale du lustre à la commande (minimum 1020 mm). / Precise the total height of the chandelier when ordering (40.16 inches minimum).

# LUSTRES - CHANDELIERS

## CHAMPS-ÉLYSÉES 6 RANGS / 6 TIERS

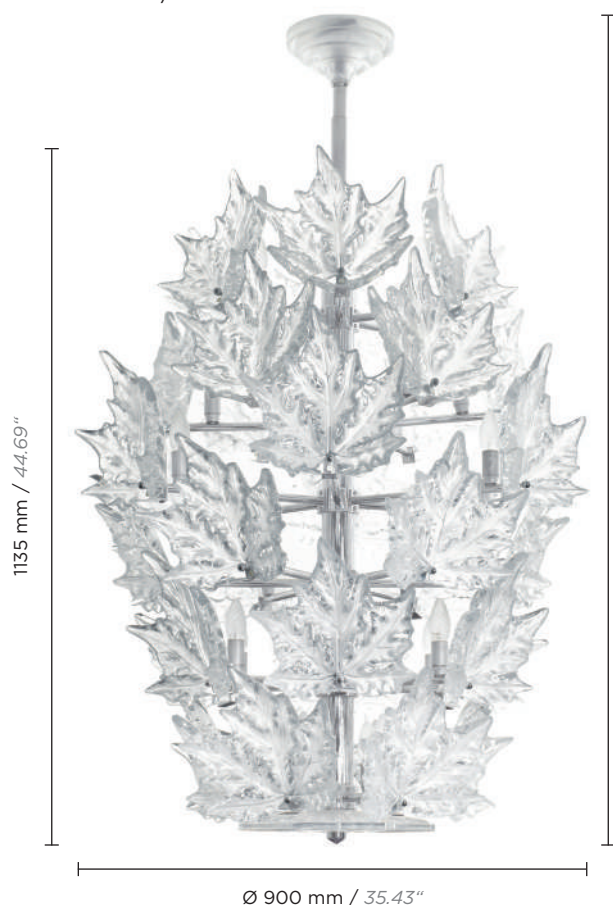

110 kg / 242.51 pounds

Incolore / Clear  
Chromé / Chrome



Lustré or / Gold luster  
Doré / Gilded

### FINITION / FINISHING

### REFERENCE

### EAN CODE



CRISTAL INCOLORE - CLEAR CRYSTAL  
CHROMÉ - CHROME

**EUROPE**  
1012300



CRISTAL INCOLORE - CLEAR CRYSTAL  
CHROMÉ - CHROME

**US**  
1012399



1995 - LALIQUE



CRISTAL INCOLORE - CLEAR CRYSTAL  
DORÉ - GILDED

**EUROPE**  
1012400



CRISTAL INCOLORE - CLEAR CRYSTAL  
DORÉ - GILDED

**US**  
1012499



1997 - LALIQUE



CRISTAL LUSTRÉ OR - GOLD LUSTER CRYSTAL  
DORÉ - GILDED

**EUROPE**  
10545400



CRISTAL LUSTRÉ OR - GOLD LUSTER CRYSTAL  
DORÉ - GILDED

**US**  
10545500



2016 - LALIQUE



E14 x 36

**CE IP20**

2700°K - Lumière chaude - Warm light

Détails techniques et instructions de montage : cf fiche architecture. / Technical datas & mounting instructions: see architecture files.

Préciser la hauteur totale du lustre à la commande (minimum 1220 mm). / Precise the total height of the chandelier when ordering (48.03 inches minimum).



### FINITION / FINISHING

		REFERENCE	EAN CODE
	CRISTAL INCOLORE - CLEAR CRYSTAL CHROMÉ - CHROME	<b>EUROPE</b> 1010200	 0 90592 09102 9
	CRISTAL INCOLORE - CLEAR CRYSTAL CHROMÉ - CHROME	<b>US</b> 1010299	 0 90592 10102 5
	CRISTAL INCOLORE - CLEAR CRYSTAL DORÉ - GILDED	<b>EUROPE</b> 1011600	 0 90592 09116 6
	CRISTAL INCOLORE - CLEAR CRYSTAL DORÉ - GILDED	<b>US</b> 1011699	 0 90592 10116 2



E27 x 3

CE IP20

2700°K - Lumière chaude - Warm light

1955 - Marc Lalique

Détails techniques et instructions de montage : cf fiche architecture. / Technical datas & mounting instructions: see architecture files.

Préciser la hauteur totale du lustre à la commande (minimum 440 mm). / Precise the total height of the chandelier when ordering (17.32 inches minimum).

# LUSTRES - CHANDELIERS

## GINKGO



42,5 kg / 93.70 pounds

Incolore / Clear  
Chromé / Chrome



Incolore / Clear  
Doré / Gilded

### FINITION / FINISHING



CRISTAL INCOLORE - CLEAR CRYSTAL  
NICKEL - NICKEL

### REFERENCE

**EUROPE**  
10580700

### EAN CODE



CRISTAL INCOLORE - CLEAR CRYSTAL  
NICKEL - NICKEL

**US**  
10580800



CRISTAL INCOLORE - CLEAR CRYSTAL  
DORÉ - GILDED

**EUROPE**  
10580900



CRISTAL INCOLORE - CLEAR CRYSTAL  
DORÉ - GILDED

**US**  
10581000



E14 x 3 - 6 watts - 520 lumens

CE IP20

4000°K - Lumière neutre - Neutral light

### 2016 - LALIQUE & DELISLE

Détails techniques et instructions de montage : cf fiche architecture. / Technical datas & mounting instructions: see architecture files.

# LUSTRES - CHANDELIERS

## HIRONDELLES PM / SS



Incolore / Clear  
Doré / Gilded



Incolore / Clear  
Chromé / Chrome

### FINITION / FINISHING



CRISTAL INCOLORE - CLEAR CRYSTAL  
CHROMÉ - CHROME

### REFERENCE

**EUROPE**  
10649400

### EAN CODE



CRISTAL INCOLORE - CLEAR CRYSTAL  
CHROMÉ - CHROME

**US**  
10649500



CRISTAL INCOLORE - CLEAR CRYSTAL  
DORÉ - GILDED

**EUROPE**  
10649600



CRISTAL INCOLORE - CLEAR CRYSTAL  
DORÉ - GILDED

**US**  
10649700



E26-E27

CE IP20

2700°K - 4100°K Lumière neutre ou chaude - neutral or warm light

2018 - LALIQUE

Détails techniques et instructions de montage : cf fiche architecture. / Technical datas & mounting instructions: see architecture files.

Préciser la hauteur totale du lustre à la commande (minimum 570 mm). / Precise the total height of the chandelier when ordering (22.44 inches minimum)



# LUSTRES - CHANDELIERS

## HIRONDELLES GM / LS



Incolore / Clear  
Chromé / Chrome



Incolore / Clear  
Doré / Gilded

### FINITION / FINISHING

### REFERENCE

### EAN CODE



CRISTAL INCOLORE - CLEAR CRYSTAL  
CHROMÉ - CHROME

**EUROPE**  
10649800



CRISTAL INCOLORE - CLEAR CRYSTAL  
CHROMÉ - CHROME

**US**  
10649900



CRISTAL INCOLORE - CLEAR CRYSTAL  
DORÉ - GILDED

**EUROPE**  
10650000



CRISTAL INCOLORE - CLEAR CRYSTAL  
DORÉ - GILDED

**US**  
10650100



E26-E27

CE IP20

2700°K - 4100°K Lumière neutre ou chaude - neutral or warm light

2018 - LALIQUE

Détails techniques et instructions de montage : cf fiche architecture. / Technical datas & mounting instructions: see architecture files.

Préciser la hauteur totale du lustre à la commande (minimum 700 mm). / Precise the total height of the chandelier when ordering (27.56 inches minimum)

# LUSTRES - CHANDELIERS

## ORGUE 2 RANGS / 2 TIERS



Ø 1135 mm / 44.69"

53 kg / 116.84 pounds

Incolore / Clear  
Chromé / Chrome



Drop mini : 750 mm / 29.53"

Incolore / Clear  
Doré / Gilded

### FINITION / FINISHING



CRISTAL INCOLORE - CLEAR CRYSTAL  
CHROMÉ - CHROME

### REFERENCE

**EUROPE**  
10153200

### EAN CODE



CRISTAL INCOLORE - CLEAR CRYSTAL  
CHROMÉ - CHROME

**US**  
10158900



CRISTAL INCOLORE - CLEAR CRYSTAL  
DORÉ - GILDED

**EUROPE**  
10159000



CRISTAL INCOLORE - CLEAR CRYSTAL  
DORÉ - GILDED

**US**  
10159100



### 2011 - STUDIO ANDRÉE PUTMAN POUR LALIQUE



LED x 119 - 200 watts - 10800 lumens

CE IP20

4100°K - Lumière neutre - Neutral light

Détails techniques et instructions de montage : cf fiche architecture. / Technical datas & mounting instructions: see architecture files.

Préciser la hauteur totale du lustre à la commande. / Precise the total height of the chandelier when ordering.

Éclairage gradable avec télécommande. / Dimmable lighting with remote control.

# LUSTRES - CHANDELIERS

## ORGUE

2 RANGS MM / 2 TIERS MS



Ø 535 mm / 21.06"

22.5 kg / 49.6 pounds

Incolore / Clear  
Chromé / Chrome

Drop mini : 650 mm / 25.59"



Incolore / Clear  
Doré / Gilded

### FINITION / FINISHING



CRISTAL INCOLORE - CLEAR CRYSTAL  
CHROMÉ - CHROME

### REFERENCE

**EUROPE**  
10233100

### EAN CODE



CRISTAL INCOLORE - CLEAR CRYSTAL  
CHROMÉ - CHROME

**US**  
10233200



CRISTAL INCOLORE - CLEAR CRYSTAL  
DORÉ - GILDED

**EUROPE**  
10233300



CRISTAL INCOLORE - CLEAR CRYSTAL  
DORÉ - GILDED

**US**  
10233400



### 2011 - STUDIO ANDRÉE PUTMAN POUR LALIQUE



LED x 43 - 55 watts - 3900 lumens

CE IP20

4100°K - Lumière neutre - Neutral light

Détails techniques et instructions de montage : cf fiche architecture. / Technical datas & mounting instructions: see architecture files.  
Préciser la hauteur totale du lustre à la commande. / Precise the total height of the chandelier when ordering.

Éclairage gradable avec télécommande. / Dimmable lighting with remote control.

# LUSTRES - CHANDELIERS

## ORGUE 3 RANGS / 3 TIERS



Ø 835 mm / 32.88"

45 kg / 99.21 pounds

Incolore / Clear  
Chromé / Chrome

Drop mini : 750 mm / 29.53"



Incolore / Clear  
Doré / Gilded

### FINITION / FINISHING



CRISTAL INCOLORE - CLEAR CRYSTAL  
CHROMÉ - CHROME

### REFERENCE

**EUROPE**  
10153300

### EAN CODE



CRISTAL INCOLORE - CLEAR CRYSTAL  
CHROMÉ - CHROME

**US**  
10159200



CRISTAL INCOLORE - CLEAR CRYSTAL  
DORÉ - GILDED

**EUROPE**  
10159300



CRISTAL INCOLORE - CLEAR CRYSTAL  
DORÉ - GILDED

**US**  
10159400



### 2011 - STUDIO ANDRÉE PUTMAN POUR LALIQUE



LED x 93 - 200 watts - 8400 lumens

CE IP20

4100°K - Lumière neutre - Neutral light

Détails techniques et instructions de montage : cf fiche architecture. / Technical datas & mounting instructions: see architecture files.  
Préciser la hauteur totale du lustre à la commande. / Precise the total height of the chandelier when ordering.

Éclairage gradable avec télécommande. / Dimmable lighting with remote control.

## PERLES



Ø 1009 mm / 39.72"

87 kg / 191.80 pounds

Incolore / Clear  
Nickel / Nickel

### FINITION / FINISHING

### REFERENCE

### EAN CODE



CRISTAL INCOLORE - CLEAR CRYSTAL  
NICKEL- NICKEL

**EUROPE**  
10689700



CRISTAL INCOLORE - CLEAR CRYSTAL  
NICKEL- NICKEL

**US**  
10689800



CRISTAL INCOLORE - CLEAR CRYSTAL  
DORÉ SATINÉ- SATIN GILDED

**EUROPE**  
10689900



CRISTAL INCOLORE - CLEAR CRYSTAL  
DORÉ SATINÉ- SATIN GILDED

**US**  
10690000



### 2017 - PIERRE-YVES ROCHON POUR LALIQUE



LED x 108 - 300 watts

**CE IP20**

2700°K - Lumière chaude - Warm light

Détails techniques et instructions de montage : cf fiche architecture. / Technical datas & mounting instructions: see architecture files.  
Préciser la hauteur totale du lustre à la commande. / Precise the total height of the chandelier when ordering.

Éclairage gradable avec télécommande. / Dimmable lighting with remote control.



### FINITION / FINISHING

### REFERENCE

### EAN CODE



**PETIT MODÈLE - SMALL SIZE**  
**16 ÉLÉMENTS - 16 ELEMENTS**  
 30 kg - H876 / L850 / l850 mm  
 66.14 pounds - H34.49" / L33.46" / W 33.46"

**EUROPE**  
 10690100  
**US**  
 10690200



**MOYEN MODÈLE - MEDIUM SIZE**  
**20 ÉLÉMENTS - 20 ELEMENTS**  
 37 kg - H1206 / L1000 / l1000 mm  
 81.57 pounds - H47.48" / L39.37" / W 39.37"

**EUROPE**  
 10690300  
**US**  
 10690400



**GRAND MODÈLE - LARGE SIZE**  
**25 ÉLÉMENTS - 25 ELEMENTS**  
 55 kg - H1306 / L1300 / l1300 mm  
 121.25 pounds - H51.42" / L51.18" / W 51.18"

**EUROPE**  
 10690500  
**US**  
 10690600



2019

Détails techniques et instructions de montage : cf fiche architecture. / Technical datas & mounting instructions: see architecture files.



AMPOULES G9

CE IP20

2700°K - Lumière chaude - Warm light

Éclairage gradable avec télécommande. / Dimmable lighting with remote control.

# LUSTRES - CHANDELIERS

## SERENE

6 PRISMES, CIRCULAIRE / 6 PRISMS, CIRCULAR

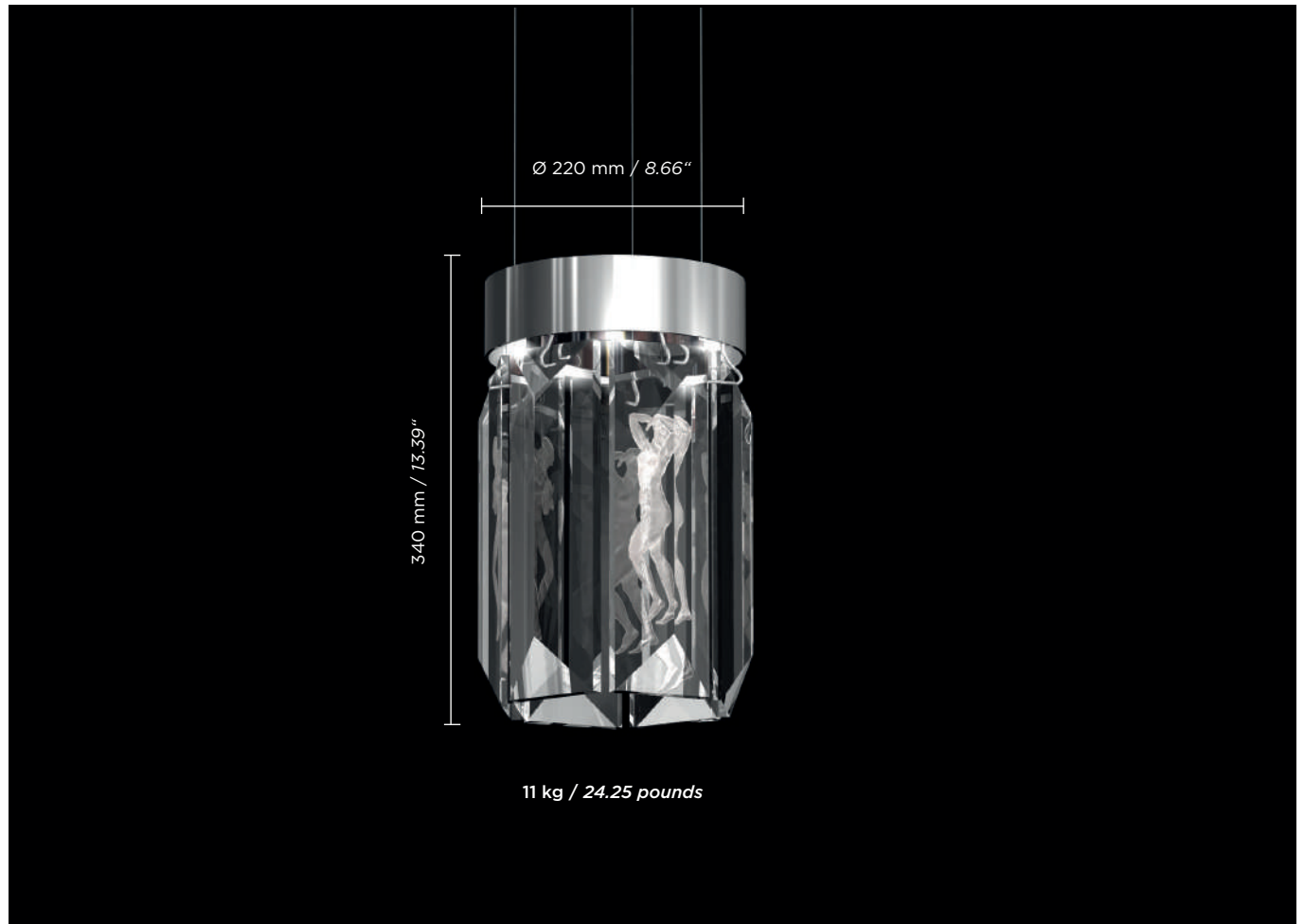

FINITION / FINISHING	REFERENCE	EAN CODE
<b>DAHLIA</b>  CRISTAL INCOLORE CLEAR CRYSTAL	10435800	 0 90592 91573 8
<b>FIGURINES</b>  CRISTAL INCOLORE CLEAR CRYSTAL	10435700	 0 90592 91574 5

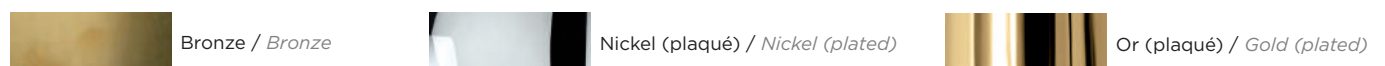

3 finitions de montage disponibles. Merci de préciser la finition souhaitée lors de la commande.  
3 available mounting finishing. Please specify the desired finishing when ordering.

 LED G4 x 6 - 9 watts - 540 lumens	 <b>IP30</b> 2700°K - Lumière chaude - Warm light	Luminaire non gradable. / Non dimmable lighting.
---	--	--

### 2014 - WINDFALL & LALIQUE

Détails techniques et instructions de montage : cf fiche architecture. / Technical datas & mounting instructions: see architecture files.  
Hauteur réglable. Pas de drop minimum. / Height adjustable. No minimum drop.

Compositions de cristal et finitions métal réalisables sur mesure. / Bespoke crystal and metal finishing customized choice available upon request.

## SERENE 12 PRISMES, CIRCULAIRE / 12 PRISMS, CIRCULAR



FINITION / FINISHING

REFERENCE

EAN CODE

**DAHLIA**



CRISTAL INCOLORE  
CLEAR CRYSTAL

10432400



**FIGURINES**



CRISTAL INCOLORE  
CLEAR CRYSTAL

10432500



Bronze / Bronze



Nickel (plaqué) / Nickel (plated)



Or (plaqué) / Gold (plated)

3 finitions de monture disponibles. Merci de préciser la finition souhaitée lors de la commande.  
3 available mounting finishing. Please specify the desired finishing when ordering.



LED G4 x 12 - 18 watts - 1080 lumens



**IP30** 2700°K - Lumière chaude - Warm light

Luminaire non gradable. / Non dimmable lighting.

### 2014 - WINDFALL & LALIQUÉ

Détails techniques et instructions de montage : cf fiche architecture. / Technical datas & mounting instructions: see architecture files.  
Hauteur réglable. Pas de drop minimum. / Height adjustable. No minimum drop.

Compositions de cristal et finitions métal réalisables sur mesure. / Bespoke crystal and metal finishing customized choice available upon request.



# LUSTRES - CHANDELIERS

## SERENE

18 PRISMES, CIRCULAIRE / 18 PRISMS, CIRCULAR

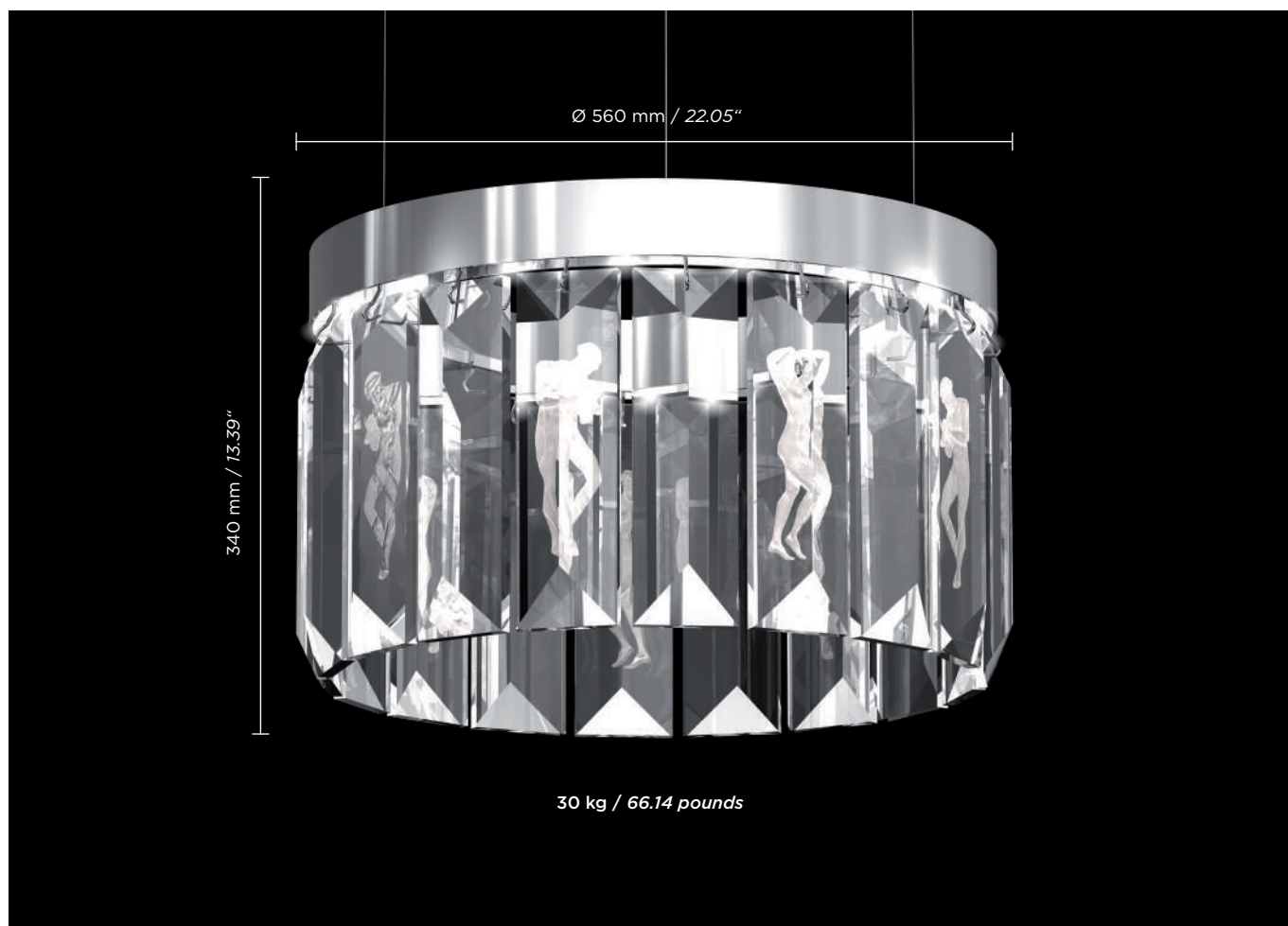

FINITION / FINISHING		REFERENCE	EAN CODE
<b>DAHLIA</b>	 CRISTAL INCOLORE CLEAR CRYSTAL	10436100	0 90592 91570 7
<b>FIGURINES</b>	 CRISTAL INCOLORE CLEAR CRYSTAL	10432600	0 90592 91607 0

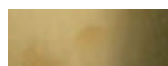

Bronze / Bronze



Nickel (plaqué) / Nickel (plated)



Or (plaqué) / Gold (plated)

3 finitions de monture disponibles. Merci de préciser la finition souhaitée lors de la commande.  
3 available mounting finishing. Please specify the desired finishing when ordering.



LED G4 x 18 - 27 watts - 1620 lumens

CE IP30

2700°K - Lumière chaude - Warm light

Luminaire non gradable. / Non dimmable lighting.

### 2014 - WINDFALL & LALIQUE

Détails techniques et instructions de montage : cf fiche architecture. / Technical datas & mounting instructions: see architecture files.  
Hauteur réglable. Pas de drop minimum. / Height adjustable. No minimum drop.

Compositions de cristal et finitions métal réalisables sur mesure. / Bespoke crystal and metal finishing customized choice available upon request.

# LUSTRES - CHANDELIERS

SERENE

24 PRISMES, CIRCULAIRE / 24 PRISMS, CIRCULAR

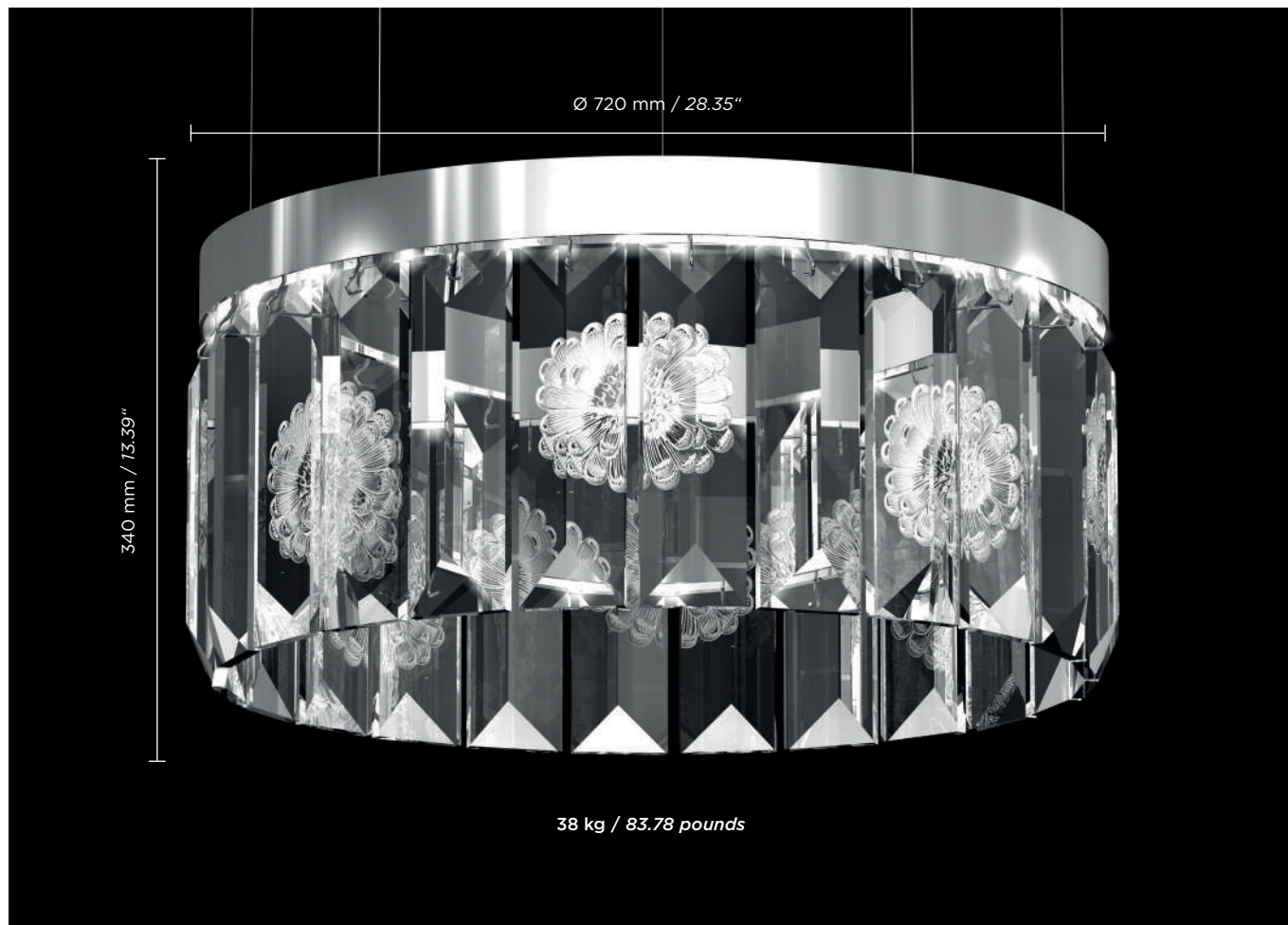

FINITION / FINISHING		REFERENCE	EAN CODE
<b>DAHLIA</b>	 CRISTAL INCOLORE CLEAR CRYSTAL	10436300	0 90592 91568 4
<b>FIGURINES</b>	 CRISTAL INCOLORE CLEAR CRYSTAL	10436200	0 90592 91569 1



Bronze / Bronze



Nickel (plaqué) / Nickel (plated)



Or (plaqué) / Gold (plated)

3 finitions de montage disponibles. Merci de préciser la finition souhaitée lors de la commande.  
3 available mounting finishing. Please specify the desired finishing when ordering.



LED G4 x 24 - 36 watts - 2160 lumens

CE IP30 2700°K - Lumière chaude - Warm light

Luminaire non gradable. / Non dimmable lighting.

## 2014 - WINDFALL & LALIQUE

Détails techniques et instructions de montage : cf fiche architecture. / Technical datas & mounting instructions: see architecture files.

Hauteur réglable. Pas de drop minimum. / Height adjustable. No minimum drop.



Compositions de cristal et finitions métal réalisables sur mesure. / Bespoke crystal and metal finishing customized choice available upon request.

# LUSTRES - CHANDELIERS

## SERENE

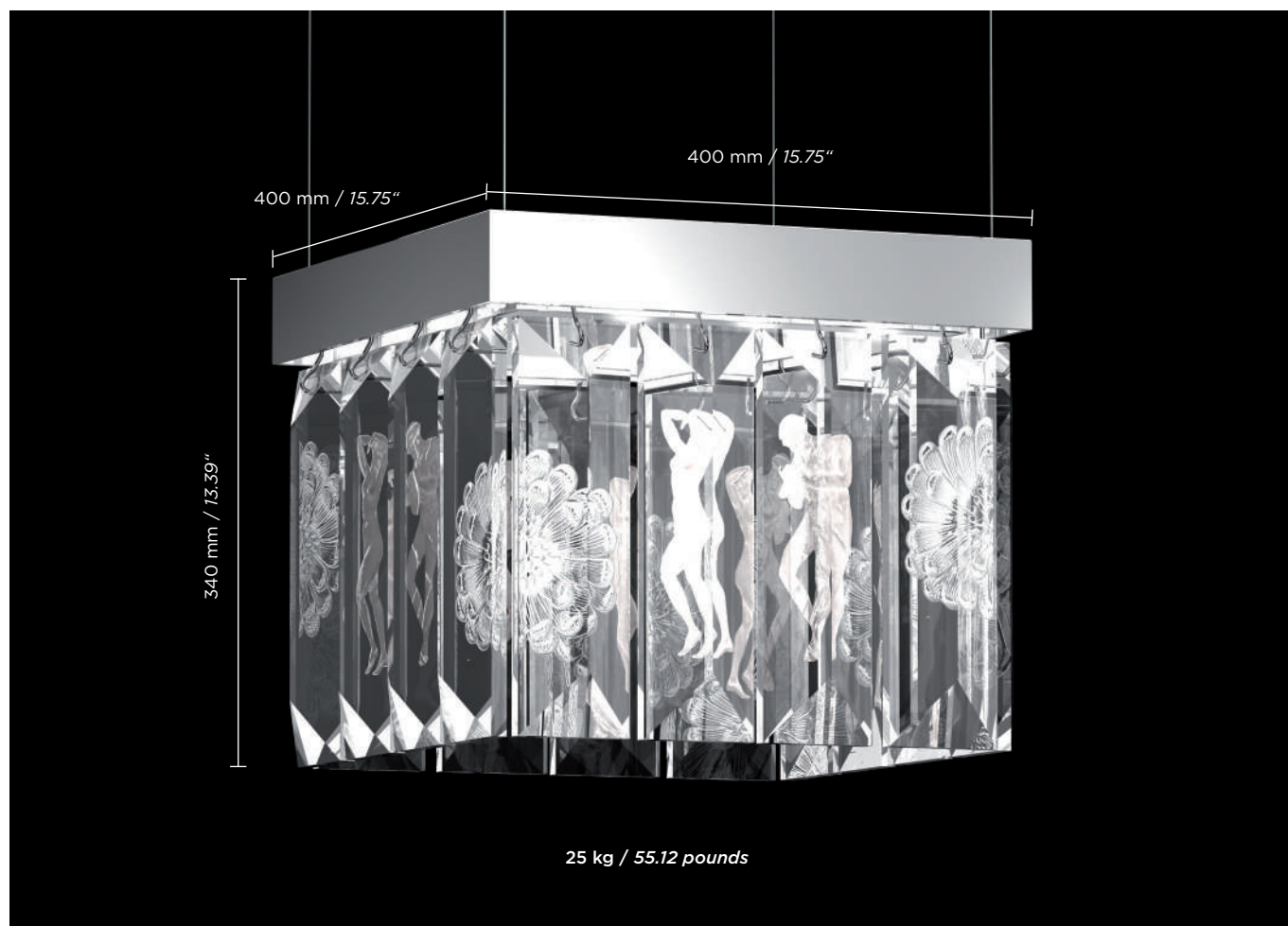
16 PRISMES, CARRÉ / 16 PRISMS, SQUARE



FINITION / FINISHING	REFERENCE	EAN CODE
<b>FIGURINES ET DAHLIA</b>  CRISTAL INCOLORE CLEAR CRYSTAL	10432900	0 90592 91604 9
<b>DAHLIA</b>  CRISTAL INCOLORE CLEAR CRYSTAL	10436000	0 90592 91571 4
<b>FIGURINES</b>  CRISTAL INCOLORE CLEAR CRYSTAL	10435900	0 90592 91572 1

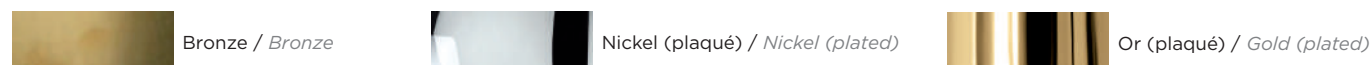

3 finitions de monture disponibles. Merci de préciser la finition souhaitée lors de la commande.  
3 available mounting finishing. Please specify the desired finishing when ordering.

 LED G4 x 12 - 18 watts - 1080 lumens	 <b>IP30</b> 2700°K - Lumière chaude - Warm light	Luminaire non gradable. / Non dimmable lighting.
--	--	--

### 2014 - WINDFALL & LALIQUE



Détails techniques et instructions de montage : cf fiche architecture. / Technical datas & mounting instructions: see architecture files.  
Hauteur réglable. Pas de drop minimum. / Height adjustable. No minimum drop.

Compositions de cristal et finitions métal réalisables sur mesure. / Bespoke crystal and metal finishing customized choice available upon request.

# LUSTRES - CHANDELIERS

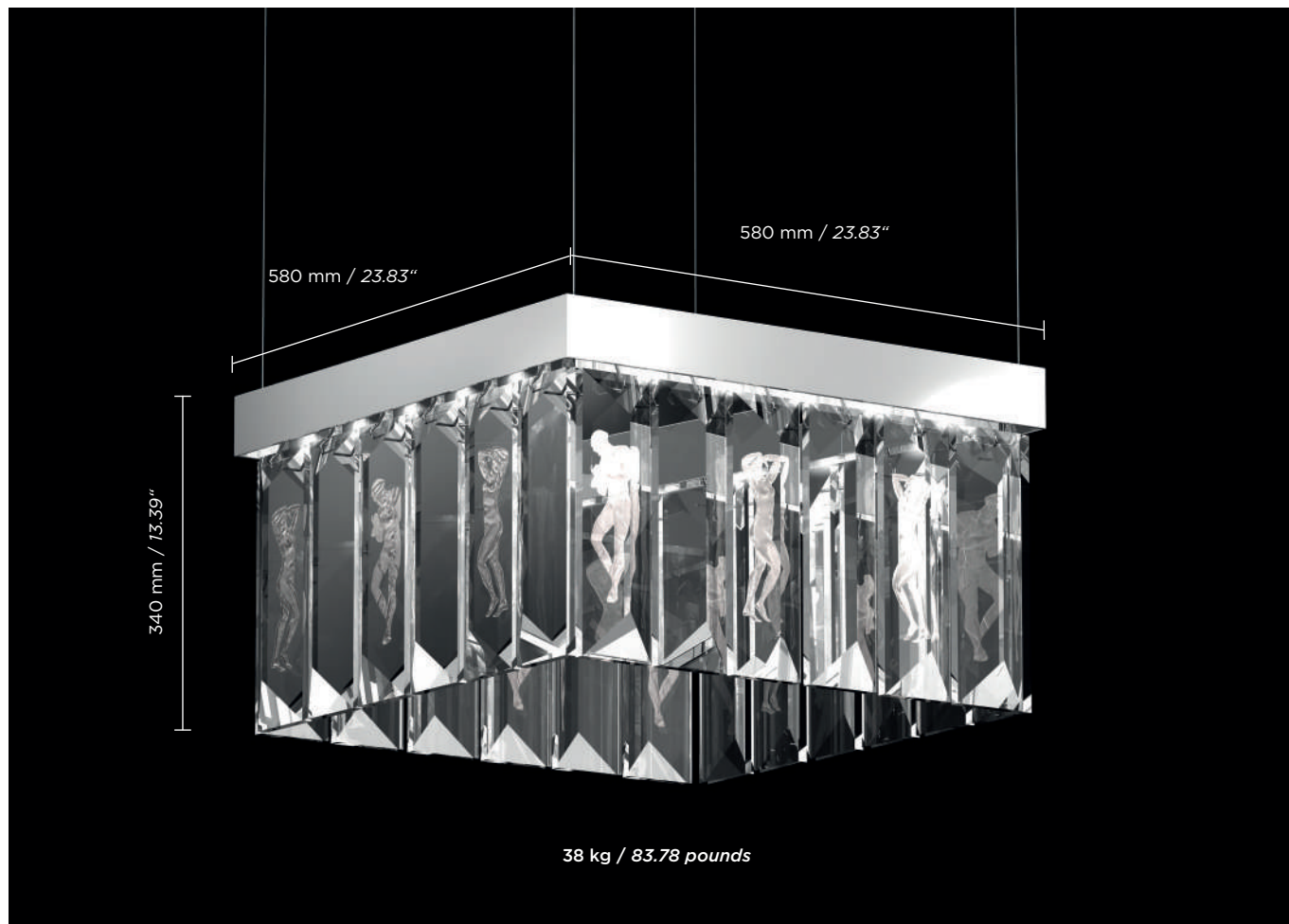
## SERENE 24 PRISMES, CARRÉ / 24 PRISMS, SQUARE



FINITION / FINISHING	REFERENCE	EAN CODE
<b>FIGURINES ET DAHLIA</b>  CRISTAL INCOLORE CLEAR CRYSTAL	10436600	0 90592 91565 3
<b>DAHLIA</b>  CRISTAL INCOLORE CLEAR CRYSTAL	10436500	0 90592 91566 0
<b>FIGURINES</b>  CRISTAL INCOLORE CLEAR CRYSTAL	10436400	0 90592 91567 7

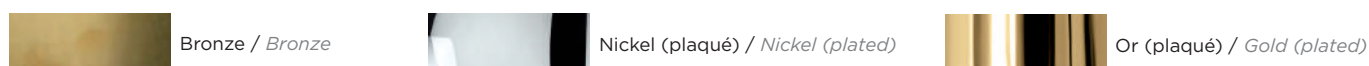

3 finitions de montage disponibles. Merci de préciser la finition souhaitée lors de la commande.  
3 available mounting finishing. Please specify the desired finishing when ordering.

 LED G4 x 12 - 30 watts - 1800 lumens **CE IP30** 2700°K - Lumière chaude - Warm light Luminaire non gradable. / Non dimmable lighting.

### 2014 - WINDFALL & LALIQUE

Détails techniques et instructions de montage : cf fiche architecture. / Technical datas & mounting instructions: see architecture files.  
Hauteur réglable. Pas de drop minimum. / Height adjustable. No minimum drop.

Compositions de cristal et finitions métal réalisables sur mesure. / Bespoke crystal and metal finishing customized choice available upon request.

# LUSTRES - CHANDELIERS

## SERENE

26 PRISMES, RECTANGULAIRE / 26 PRISMS, RECTANGULAR

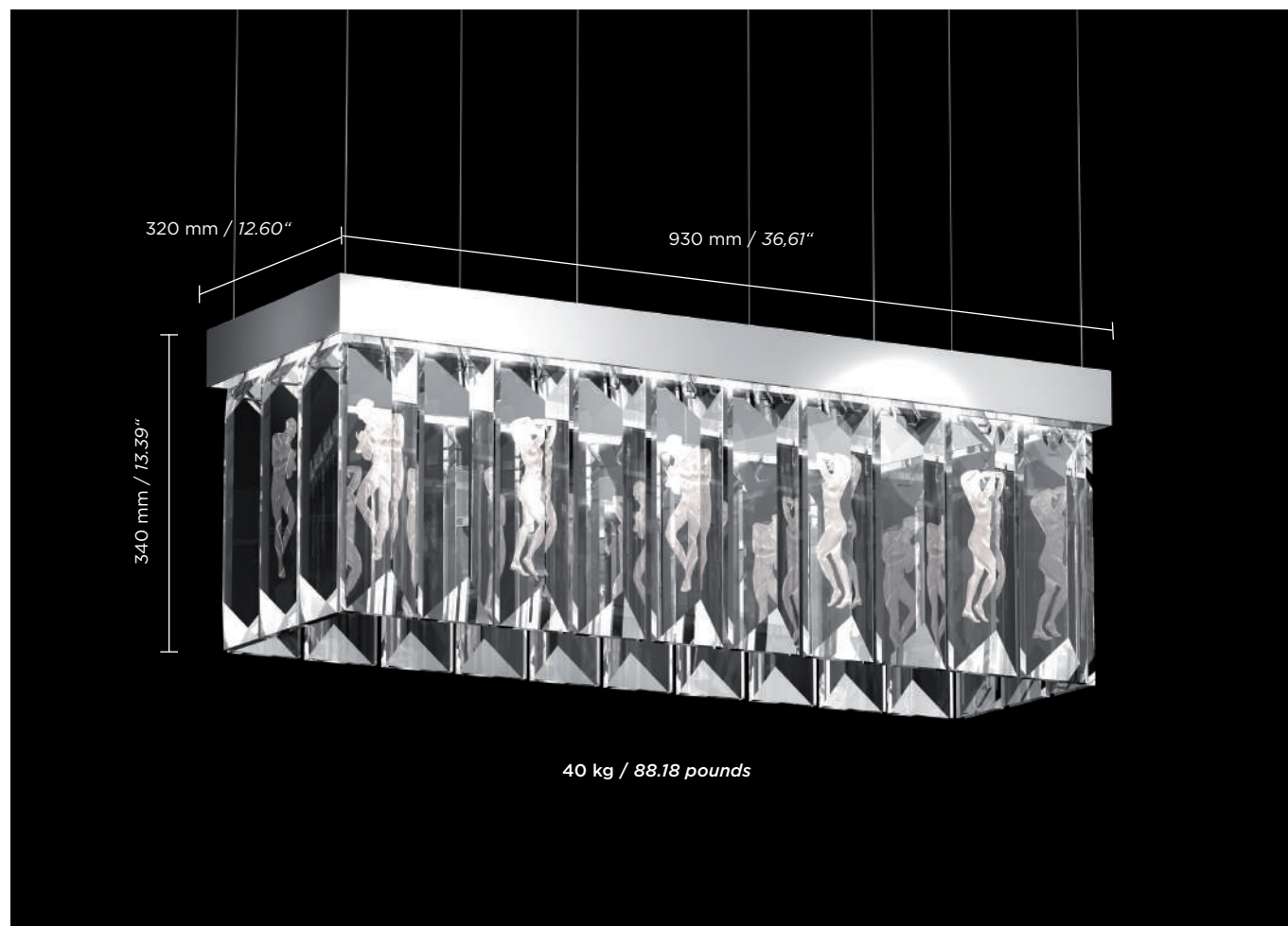

FINITION / FINISHING	REFERENCE	EAN CODE
<b>DAHLIA</b>  CRISTAL INCOLORE CLEAR CRYSTAL	10436700	0 90592 91564 6
<b>FIGURINES</b>  CRISTAL INCOLORE CLEAR CRYSTAL	10432700	0 90592 91606 3



3 finitions de montage disponibles. Merci de préciser la finition souhaitée lors de la commande.  
3 available mounting finishing. Please specify the desired finishing when ordering.

 LED G4 x 22 - 33 watts - 1980 lumens  **IP30** 2700°K - Lumière chaude - Warm light Luminaire non gradable. / Non dimmable lighting.

### 2014 - WINDFALL & LALIQUE

Détails techniques et instructions de montage : cf fiche architecture. / Technical datas & mounting instructions: see architecture files.  
Hauteur réglable. Pas de drop minimum. / Height adjustable. No minimum drop.

Compositions de cristal et finitions métal réalisables sur mesure. / Bespoke crystal and metal finishing customized choice available upon request.

# LUSTRES - CHANDELIERS

## SERENE

40 PRISMES, RECTANGULAIRE / 40 PRISMS, RECTANGULAR

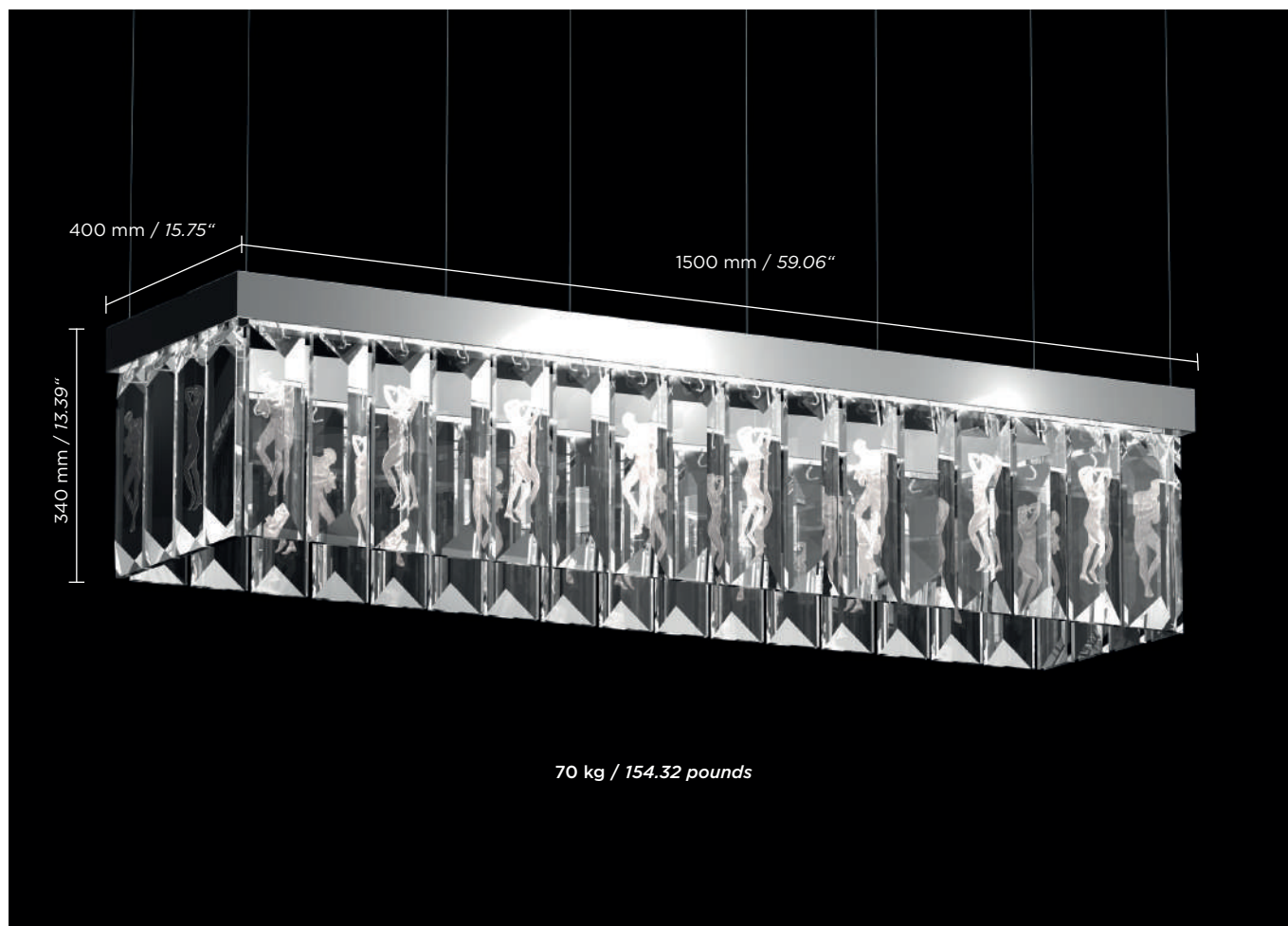

FINITION / FINISHING	REFERENCE	EAN CODE
<b>DAHLIA</b>  CRISTAL INCOLORE CLEAR CRYSTAL	10436900	0 90592 91562 2
<b>FIGURINES</b>  CRISTAL INCOLORE CLEAR CRYSTAL	10436800	0 90592 91563 9



Bronze / Bronze



Nickel (plaqué) / Nickel (plated)



Or (plaqué) / Gold (plated)

3 finitions de montage disponibles. Merci de préciser la finition souhaitée lors de la commande.  
 3 available mounting finishing. Please specify the desired finishing when ordering.



LED G4 x 36 - 54 watts - 3240 lumens

CE IP30

2700°K - Lumière chaude - Warm light

Luminaire non gradable. / Non dimmable lighting.

### 2014 - WINDFALL & LALIQUE

Détails techniques et instructions de montage : cf fiche architecture. / Technical datas & mounting instructions: see architecture files.  
 Hauteur réglable. Pas de drop minimum. / Height adjustable. No minimum drop.

Compositions de cristal et finitions métal réalisables sur mesure. / Bespoke crystal and metal finishing customized choice available upon request.

# PLAFONNIER - CEILING LIGHT

## CORALLINE



10.40 kg / 22.93 pounds

### FINITION / FINISHING



CRISTAL INCOLORE - CLEAR CRYSTAL  
CHROMÉ - CHROME



CRISTAL INCOLORE - CLEAR CRYSTAL  
CHROMÉ - CHROME

### REFERENCE

**EUROPE**  
1012700

**US**  
1012799

### EAN CODE



0 90592 04036 2



0 90592 04037 9



E14 x 3

**CE IP20**

2700°K - Lumière chaude - Warm light

2004 - LALIQUE

Détails techniques et instructions de montage : cf fiche architecture. / Technical datas & mounting instructions: see architecture files.

# SUSPENSIONS - CEILING LAMPS

COUTARD



4,20 kg / 9.26 pounds

## FINITION / FINISHING



CRISTAL INCOLORE - CLEAR CRYSTAL  
CHROMÉ - CHROME



CRISTAL INCOLORE - CLEAR CRYSTAL  
CHROMÉ - CHROME

## REFERENCE

**EUROPE**  
10552800

**US**  
10552900

## EAN CODE



LED x 28 - 9 watts - 730 lumens

**CE IP20**

2700°K - Lumière chaude - Warm light à / to 4100°K - Lumière neutre - Neutral light

2017 - LALIQUÉ

Détails techniques et instructions de montage : cf fiche architecture. / Technical datas & mounting instructions: see architecture files.



# SUSPENSIONS - CEILING LAMPS

## GINKGO PM / SS



Ø 370 mm / 14.57"

8,5 kg / 18.74 pounds

Incolore / Clear  
Chromé / Chrome



Incolore / Clear  
Doré / Gilded

### FINITION / FINISHING



CRISTAL INCOLORE - CLEAR CRYSTAL  
NICKEL - NICKEL

### REFERENCE

**EUROPE**  
10579900

### EAN CODE



CRISTAL INCOLORE - CLEAR CRYSTAL  
NICKEL - NICKEL

**US**  
10580000



CRISTAL INCOLORE - CLEAR CRYSTAL  
DORÉ - GILDED

**EUROPE**  
10580100



CRISTAL INCOLORE - CLEAR CRYSTAL  
DORÉ - GILDED

**US**  
10580200



E14 x 3 - 6 watts - 520 lumens

CE IP20

4100°K - Lumière neutre - Neutral light

### 2016 - LALIQUE & DELISLE

Détails techniques et instructions de montage : cf fiche architecture. / Technical datas & mounting instructions: see architecture files.

# SUSPENSIONS - CEILING LAMPS

GINKGO  
GM / LS



Incolore / Clear  
Chromé / Chrome

830 mm / 32.68"



Ø 670 mm / 26.38"

26,5 kg / 58.42 pounds

Incolore / Clear  
Doré / Gilded

## FINITION / FINISHING



CRISTAL INCOLORE - CLEAR CRYSTAL  
NICKEL - NICKEL

## REFERENCE

**EUROPE**  
10580300

## EAN CODE



CRISTAL INCOLORE - CLEAR CRYSTAL  
NICKEL - NICKEL

**US**  
10580400



CRISTAL INCOLORE - CLEAR CRYSTAL  
DORÉ - GILDED

**EUROPE**  
10580500



CRISTAL INCOLORE - CLEAR CRYSTAL  
DORÉ - GILDED

**US**  
10580600



E14 x 13 - 6 watts - 520 lumens

CE IP20

4000°K - Lumière neutre - Neutral light

2017 - LALIQUE & DELISLE

Détails techniques et instructions de montage : cf fiche architecture. / Technical datas & mounting instructions: see architecture files.

# SUSPENSIONS - CEILING LAMPS

## PLUME



Ø 88 mm / 3.46"

1,5 kg / 3.31 pounds

Incolore / Clear  
Chromé / Chrome



Ø 114 mm / 4.49"

2 kg / 4.41 pounds

Incolore / Clear  
Chromé / Chrome

### FINITION / FINISHING



Ø 88 mm / 3.46"

**CRISTAL INCOLORE - CLEAR CRYSTAL**  
CHROMÉ - CHROME

### REFERENCE

**EUROPE**  
10690700  
**US**  
10690800

### EAN CODE



Ø 114 mm / 4.49"

**CRISTAL INCOLORE - CLEAR CRYSTAL**  
CHROMÉ - CHROME

**EUROPE**  
10690900  
**US**  
10691000



2019

Détails techniques et instructions de montage : cf fiche architecture. / *Technical datas & mounting instructions: see architecture files.*



AMPOULES G9

CE IP20

2700°K - Lumière chaude - Warm light

Éclairage gradable avec variateur. / *Dimmable lighting with dimmer.*

# SUSPENSIONS - CEILING LAMPS

## SERENE PRISME SIMPLE / SIMPLE PRISM



FINITION / FINISHING		REFERENCE	EAN CODE
<b>DAHLIA</b>	 CRISTAL INCOLORE CLEAR CRYSTAL	10433300	 0 90592 91600 1
<b>FIGURINES</b>	 CRISTAL INCOLORE CLEAR CRYSTAL	10433200	 0 90592 91601 8
<b>SANS MOTIFS WITHOUT MOTIV</b>	 CRISTAL INCOLORE CLEAR CRYSTAL	10433400	 0 90592 91599 8



Bronze / Bronze



Nickel (plaqué) / Nickel (plated)



Or (plaqué) / Gold (plated)

3 finitions de monture disponibles. Merci de préciser la finition souhaitée lors de la commande.  
3 available mounting finishing. Please specify the desired finishing when ordering.



LED (rétroéclairage depuis le plafond / downlight from the ceiling)



Luminaire non gradable. / Non dimmable lighting.

### 2014 - WINDFALL & LALIQUE

Détails techniques et instructions de montage : cf fiche architecture. / Technical datas & mounting instructions: see architecture files.

Hauteur réglable. Pas de drop minimum. / Height adjustable. No minimum drop.

Compositions de cristal et finitions métal réalisables sur mesure. / Bespoke crystal and metal finishing customized choice available upon request.

# SUSPENSIONS - CEILING LAMPS

## SERENE PRISME DOUBLE / DOUBLE PRISM

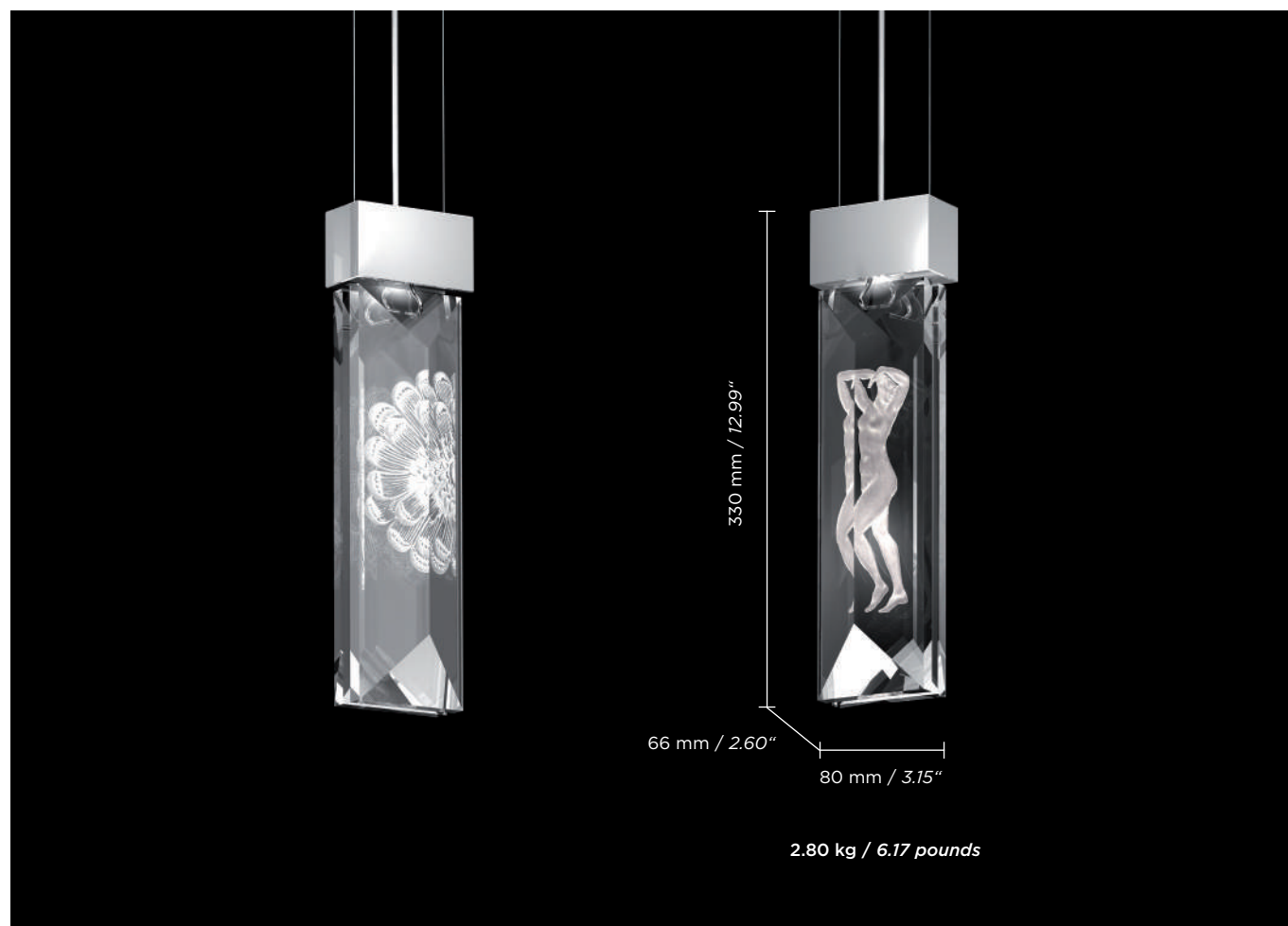

FINITION / FINISHING	REFERENCE	EAN CODE
<b>DAHLIA</b>  CRISTAL INCOLORE CLEAR CRYSTAL	10433100	 0 90592 91602 5
<b>FIGURINES</b>  CRISTAL INCOLORE CLEAR CRYSTAL	10433000	 0 90592 91603 2
 Bronze / Bronze	 Nickel (plaqué) / Nickel (plated)	 Or (plaqué) / Gold (plated)

3 finitions de monture disponibles. Merci de préciser la finition souhaitée lors de la commande.  
 3 available mounting finishing. Please specify the desired finishing when ordering.



LED G4 x 1 - 1,5 watts - 90 lumens



2700°K - Lumière chaude - Warm light

Luminaire non gradable. / Non dimmable lighting.

### 2014 - WINDFALL & LALIQUE

Détails techniques et instructions de montage : cf fiche architecture. / Technical datas & mounting instructions: see architecture files.  
 Hauteur réglable. Pas de drop minimum. / Height adjustable. No minimum drop.

Compositions de cristal et finitions métal réalisables sur mesure. / Bespoke crystal and metal finishing customized choice available upon request.

# SUSPENSIONS - CEILING LAMPS

## SERENE 32 PRISMES SIMPLE / 32 SIMPLE PRISMS

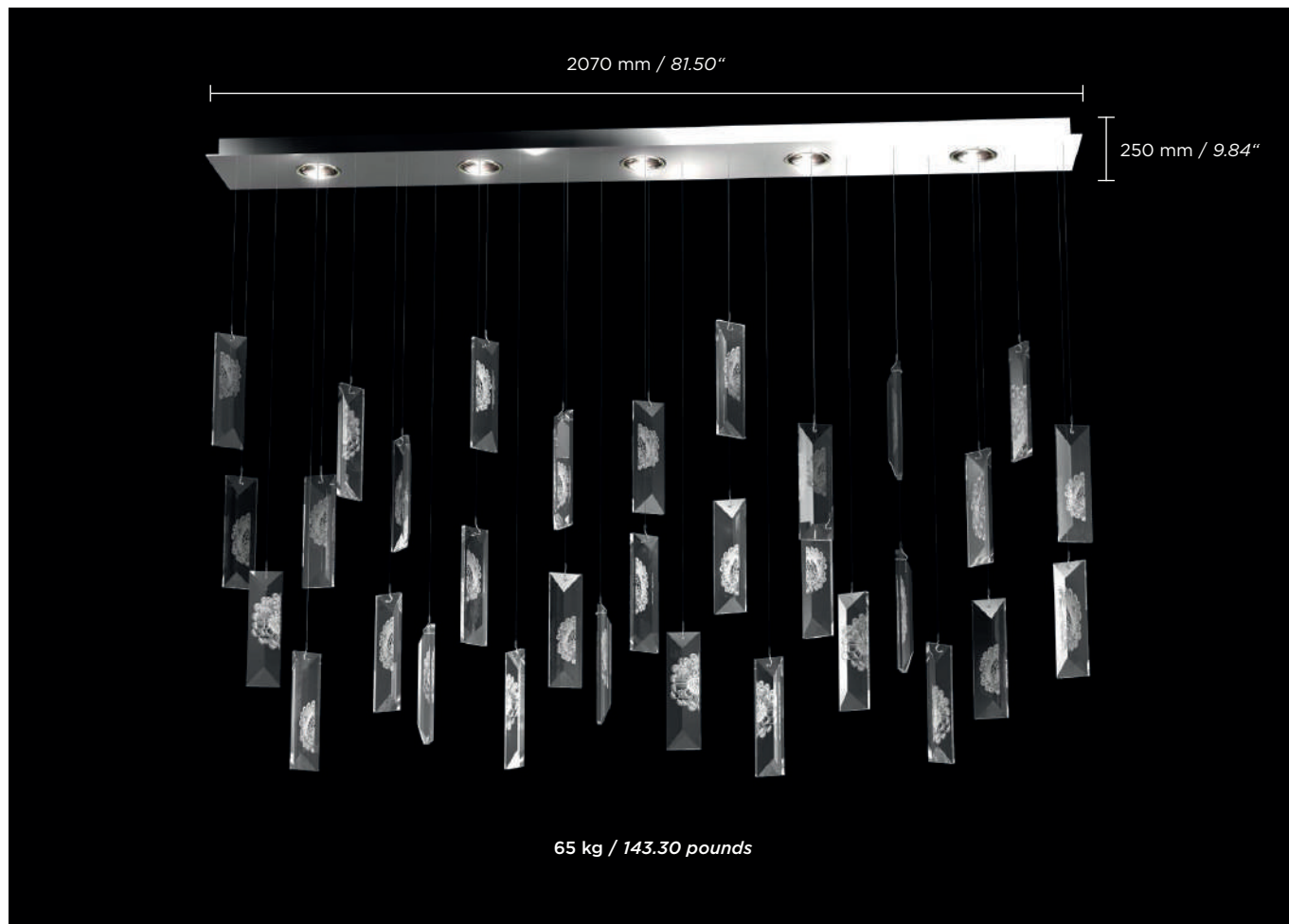

FINITION / FINISHING

REFERENCE

EAN CODE

DAHLIA



CRISTAL INCOLORE  
CLEAR CRYSTAL

10450000



Bronze / Bronze



Nickel (plaqué) / Nickel (plated)



Or (plaqué) / Gold (plated)

3 finitions de montage disponibles. Merci de préciser la finition souhaitée lors de la commande.  
3 available mounting finishing. Please specify the desired finishing when ordering.



LED (rétroéclairage depuis le plafond / downlight from the ceiling)

CE IP30

Luminaire non gradable. / Non dimmable lighting.

### 2014 - WINDFALL & LALIQUE

Détails techniques et instructions de montage : cf fiche architecture. / Technical datas & mounting instructions: see architecture files.  
Hauteur réglable. Pas de drop minimum. / Height adjustable. No minimum drop.

Compositions de cristal et finitions métal réalisables sur mesure. / Bespoke crystal and metal finishing customized choice available upon request.

## VIBRATION



### FINITION / FINISHING



CRISTAL INCOLORE - CLEAR CRYSTAL  
CHROMÉ - CHROME



CRISTAL INCOLORE - CLEAR CRYSTAL  
CHROMÉ - CHROME

### REFERENCE

**EUROPE**  
1158200

**US**  
1158299

### EAN CODE



E14 x 1

**CE IP20**

2700°K - Lumière chaude - Warm light

2006 - LALIQUE

Longueur maximum : 2000 mm. / Height maximum: 78.74 inches.

Détails techniques et instructions de montage : cf fiche architecture. / Technical datas & mounting instructions: see architecture files.

TABLES & MEUBLES DE RANGEMENT  
*TABLES & CABINETS*





# BUREAU - *DESK*

## COUTARD

ÉDITION NUMÉROTÉE / *NUMBERED EDITION*



FINITION / *FINISHING*

REFERENCE

EAN CODE



CRISTAL INCOLORE - *CLEAR CRYSTAL*  
CUIR - *LEATHER*  
MACASSAR - *MACASSAR*

10643300



CRISTAL INCOLORE - *CLEAR CRYSTAL*  
CUIR - *LEATHER*  
NICKEL - *NICKEL*

10643400



2018 - PIERRE-YVES ROCHON POUR LALIQUE

# COMMODE - *DRAWER UNIT*

## VIBRATION

ÉDITION NUMÉROTÉE / *NUMBERED EDITION*



220 kg / 485.02 pounds

FINITION / *FINISHING*

REFERENCE

EAN CODE



CRISTAL LUSTRÉ OR - *GOLD LUSTER CRYSTAL*  
BRONZE - *BRONZE*  
MARBRE NOIR - *BLACK MARBLE*

10637600



0 90592 89417 0

2017 - PIERRE-YVES ROCHON POUR LALIQUE

# CONSOLES - CONSOLES

## CACTUS DEMI-LUNE / HALF-MOON

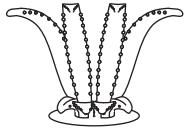

### CONSOLE SANS DALLE

Hauteur x Largeur x Profondeur - Poids :  
695 x 1140 x 600 mm - 90 kg

### CONSOLE WITHOUT TABLE TOP

Height x Width x Depth - Weight:  
27.36" x 44.88" x 23.62" - 253.53 pounds

#### FINITION / FINISHING

#### REFERENCE

#### EAN CODE



CRISTAL INCOLORE  
CLEAR CRYSTAL

1005600



1987 - Marie-Claude Lalique



CRISTAL INCOLORE ET NOIR  
CLEAR AND BLACK CRYSTAL

1005620



CRISTAL AMBRE  
AMBER CRYSTAL

1005630



2007 - LALIQUE

Détails techniques et instructions de montage : cf fiche architecture. / Technical datas & mounting instructions: see architecture files.

#### DALLES / TABLE TOPS

#### REFERENCE

#### EAN CODE



L1300 x P650 mm - E15 mm - 25 kg  
L51.18" x W25.59" - T0.59" - 55.11 pounds

10588400



L1300 x P650 mm - E15 mm - 25 kg  
L51.18" x W25.59" - T0.59" - 55.11 pounds

0105620



# CONSOLES - CONSOLES

## CACTUS RECTANGULAIRE / *RECTANGULAR*

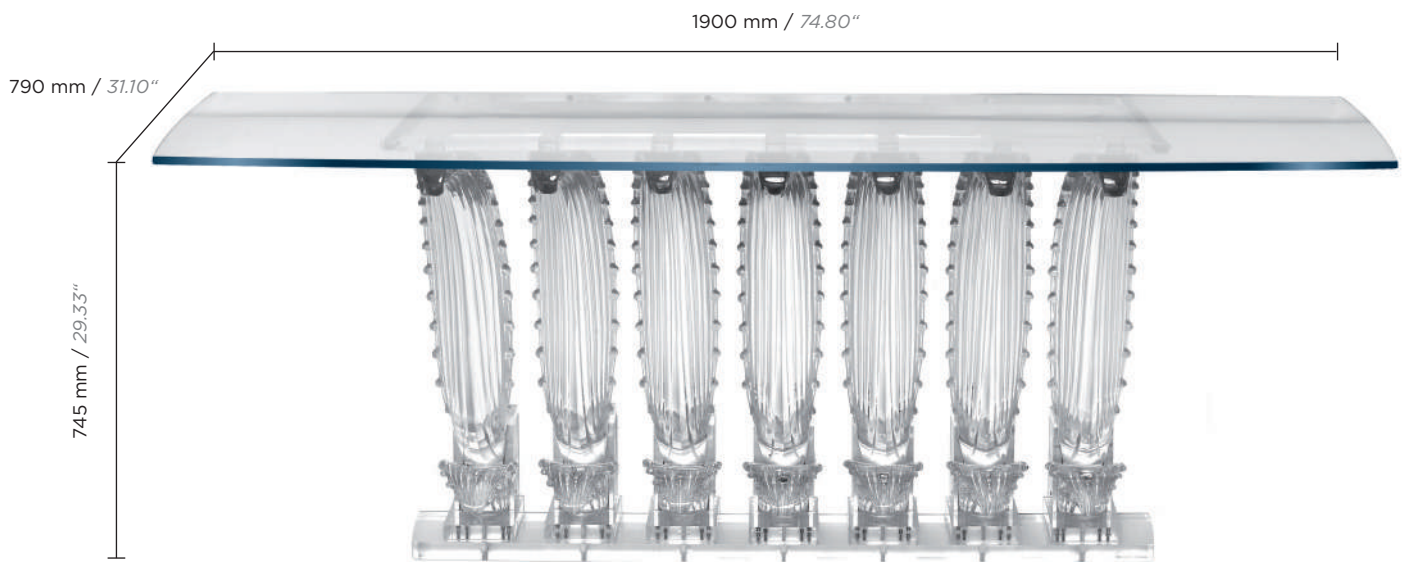

207 kg / 455.40 pounds

FINITION / *FINISHING*

REFERENCE

EAN CODE



CRISTAL INCOLORE  
*CLEAR CRYSTAL*

10588600



2009 - LALIQUE

Détails techniques et instructions de montage : cf fiche architecture. / *Technical datas & mounting instructions: see architecture files.*  
**Console livrée avec dalle.** / *Console delivered with table top.*

# CONSOLES - CONSOLES

## SÉVILLE



10,60 kg / 23.37 pounds



**CONSOLE SANS DALLE**  
Hauteur x Largeur x Profondeur - Poids :  
248 x 500 x 130 mm - 6,60 kg

**CONSOLE WITHOUT TABLE TOP**  
Height x Width x Depth - Weight:  
9.76" x 19.69" x 5.12" - 15.55 pounds

### FINITION / FINISHING



CRISTAL INCOLORE  
CLEAR CRYSTAL

### REFERENCE

1005500

### EAN CODE



1986 - Marie-Claude Lalique

Détails techniques et instructions de montage : cf fiche architecture. / Technical datas & mounting instructions: see architecture files.

Console livrée sans dalle. / Console delivered without table top.

### DALLE / TABLE TOP



L500 x P300 mm - E12 mm - 4 kg  
L19.69" x D11.81" - T0.47" - 8.82 pounds

### REFERENCE

10588300

### EAN CODE



# GUÉRIDONS - PEDESTAL TABLES

MARSAN

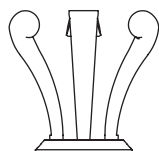

## GUÉRIDON SANS DALLE

Hauteur x Diamètre - Poids :  
660 x 700 mm - 76 kg

## PEDESTAL TABLE WITHOUT TABLE TOP

Height x Diameter - Weight:  
25.98" x 27.56" - 167.55 pounds

### FINITION / FINISHING



CRISTAL INCOLORE  
CLEAR CRYSTAL

### REFERENCE

10060500

### EAN CODE



2009 - LALIQUE

Détails techniques et instructions de montage : cf fiche architecture. / Technical datas & mounting instructions: see architecture files.  
Console livrée sans dalle. / Console delivered without table top.

### DALLES / TABLE TOPS

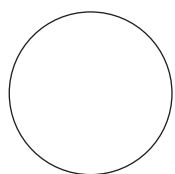

Ø 650 mm - E19 mm - 15,20 kg  
Ø 25.59" - T0.75" - 33.51 pounds

10587100



Ø 900 mm - E19 mm - 24 kg  
Ø 35.43" - T0.75" - 50.91 pounds

10587200



Ø 650 mm - E19 mm - 15,20 kg  
Ø 25.59" - T0.75" - 33.51 pounds

10060800



2014 - LALIQUE

# GUÉRIDONS - PEDESTAL TABLES

## ROSES

ÉDITION NUMÉROTÉE / *NUMBERED EDITION*



123 kg / 271.17 pounds

FINITION / *FINISHING*

REFERENCE

EAN CODE



CRISTAL INCOLORE - *CLEAR CRYSTAL*  
MACASSAR - *MACASSAR*

10643500



CRISTAL INCOLORE - *CLEAR CRYSTAL*  
NICKEL - *NICKEL*

10643600



2018 - PIERRE-YVES ROCHON POUR LALIQUE

# GUÉRIDONS - PEDESTAL TABLES

## SOUDAN

ÉDITION NUMÉROTÉE / *NUMBERED EDITION*

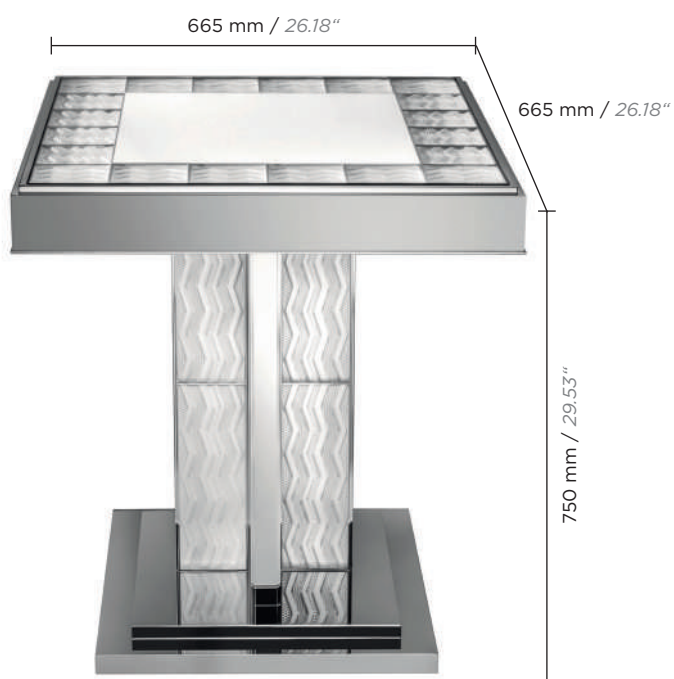

140 kg / 308.65 pounds

### FINITION / *FINISHING*

### REFERENCE

### EAN CODE



CRISTAL INCOLORE - *CLEAR CRYSTAL*  
MACASSAR - *MACASSAR*

10643700

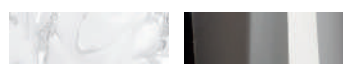

CRISTAL INCOLORE - *CLEAR CRYSTAL*  
NICKEL - *NICKEL*

10643800



2018 - PIERRE-YVES ROCHON POUR LALIQUE



# GUÉRIDONS - PEDESTAL TABLES

## VERSAILLES



12,70 kg / 28 pounds

FINITION / FINISHING

REFERENCE

EAN CODE



CRISTAL INCOLORE - CLEAR CRYSTAL  
INOX BROSSÉ - BRUSHED STAINLESS STEEL

1025700



2006 - LALIQUE

Détails techniques et instructions de montage : cf fiche architecture. / Technical datas & mounting instructions: see architecture files.

**Guéridon livré avec plateau. / Pedestal table delivered with tabletop.**

# TABLES - TABLES

## CACTUS

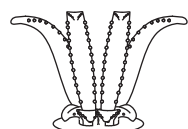
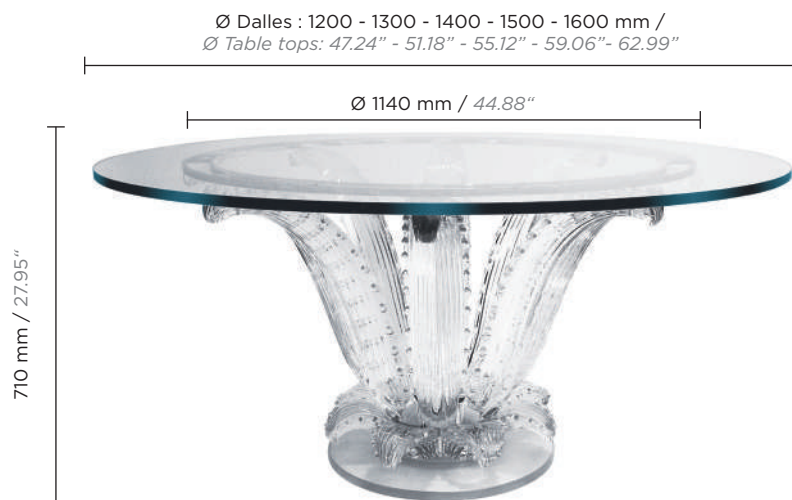

### TABLE SANS DALLE

Hauteur x Diamètre - Poids :  
 691 x 1140 mm - 144 kg

### TABLE WITHOUT TABLE TOP

Height x Diameter - Weight:  
 27.20" x 44.88" - 317.47 pounds

#### FINITION / FINISHING



1951 - Marc Lalique

CRISTAL INCOLORE  
 CLEAR CRYSTAL

REFERENCE

1030200

EAN CODE



2006 - LALIQUE

CRISTAL AMBRE  
 AMBER CRYSTAL

1030220



2007 - LALIQUE

CRISTAL INCOLORE ET NOIR  
 CLEAR AND BLACK CRYSTAL

1030230



2019 - LALIQUE

CRISTAL VERT  
 GREEN CRYSTAL

10673600



Détails techniques et instructions de montage : cf fiche architecture. / Technical datas & mounting instructions: see architecture files.

Table livrée sans dalle. / Table delivered without table top.

#### DALLES / TABLE TOPS

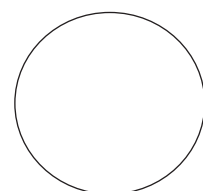

### 4 PERSONNES MAXIMUM - 4 PERSONS MAXIMUM

Ø 1200 mm - E19 mm - 43 kg  
 Ø 47.24" - T0.75" - 94.8 pounds

10587300



### 6 PERSONNES MAXIMUM - 6 PERSONS MAXIMUM

Ø 1300 mm - E19 mm - 50 kg  
 Ø 51.18" - T0.75" - 110.23 pounds

10587400



### 6 PERSONNES MAXIMUM - 6 PERSONS MAXIMUM

Ø 1400 mm - E19 mm - 74 kg  
 Ø 55.12" - T0.75" - 163.14 pounds

10587500



### 6 PERSONNES MAXIMUM - 6 PERSONS MAXIMUM

Ø 1500 mm - E19 mm - 84 kg  
 Ø 59.06" - T0.75" - 185.19 pounds

10587600



### 8 PERSONNES MAXIMUM - 8 PERSONS MAXIMUM

Ø 1600 mm - E19 mm - 96 kg  
 Ø 62.99" - T0.75" - 211.64 pounds

10587700



# TABLES - TABLES

## CACTUS DOUBLE / DOUBLE



536 kg / 1181.68 pounds

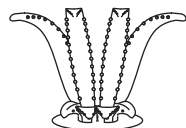

### TABLE SANS DALLE

Hauteur x Diamètre - Poids :  
691 x 1140 mm - 144 kg par pied

### TABLE WITHOUT TABLE TOP

Height x Diameter - Weight:  
27.20" x 44.88" - 317.47 pounds per table foot

### FINITION / FINISHING

### REFERENCE

### EAN CODE



CRISTAL INCOLORE  
CLEAR CRYSTAL

1030200



1951 - Marc Lalique

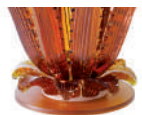

CRISTAL AMBRE  
AMBER CRYSTAL

1030220



2006 - LALIQUE



CRISTAL INCOLORE ET NOIR  
CLEAR AND BLACK CRYSTAL

1030230



2007 - LALIQUE

Détails techniques et instructions de montage : cf fiche architecture. / Technical datas & mounting instructions: see architecture files.  
Table livrée sans dalle. / Table delivered without table top.

POUR TOUTE COMMANDE D'UNE TABLE DOUBLE CACTUS, MERCI DE COMMANDER DEUX FOIS LA RÉFÉRENCE DU PIED SIMPLE CI-DESSUS.  
FOR EVERY ORDER OF A DOUBLE CACTUS TABLE, PLEASE ORDER TWICE THE REFERENCE ABOVE.

### DALLES / TABLE TOPS

### REFERENCE

### EAN CODE

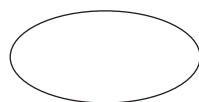

**14 PERSONNES MAXIMUM - 14 PERSONS MAXIMUM**  
L3600 x 11600 mm - E19 mm - 248 kg  
L141.73" x W62.99" - T0.75" - 546.75 pounds

10588200



# TABLES - TABLES

## CACTUS RECTANGULAIRE / RECTANGULAR

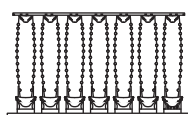
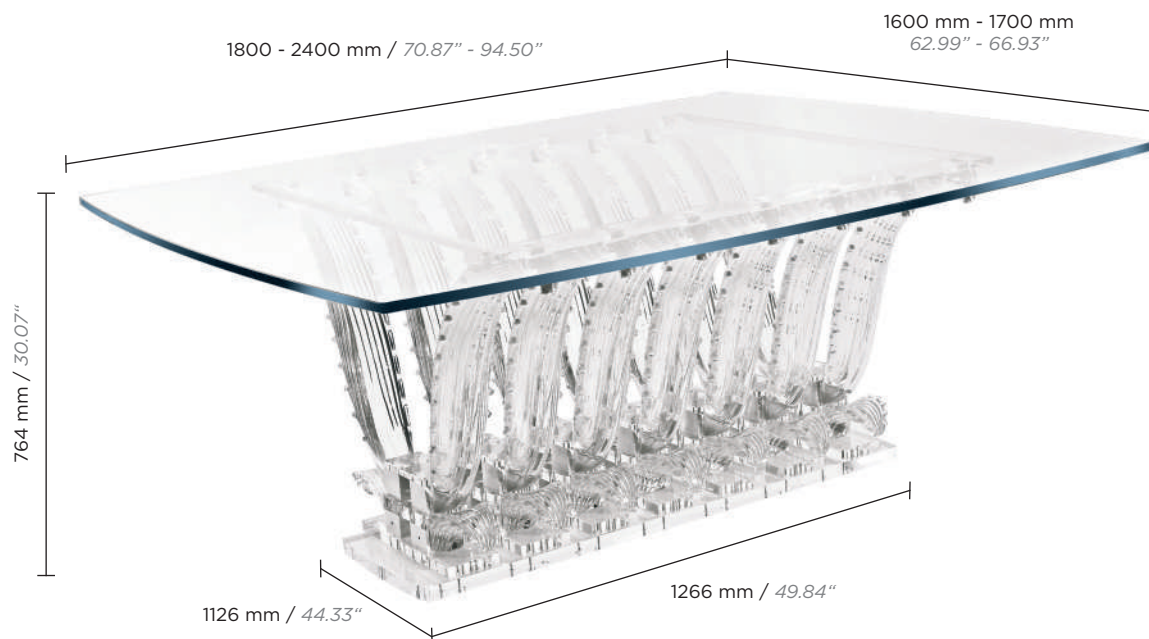

### TABLE SANS DALLE

Hauteur x Longueur x Largeur - Poids :  
745 x 1266 x 1126 mm - 275 kg

### TABLE WITHOUT TABLE TOP

Height x Length x Width - Weight:  
29.33" x 49.84" x 44.33" - 606.27 pounds

#### FINITION / FINISHING



CRISTAL INCOLORE  
CLEAR CRYSTAL

#### REFERENCE

10068100

#### EAN CODE



2009 - LALIQUE

Détails techniques et instructions de montage : cf fiche architecture. / Technical datas & mounting instructions: see architecture files.  
Table livrée sans dalle. / Table delivered without table top.

#### DALLES / TABLE TOPS



### 10 PERSONNES MAXIMUM - 10 PERSONS MAXIMUM

L1800 X 11600 mm - E19 mm - 162 kg  
L70.87" x W62.99" - T0.75" - 357.15 pounds

#### REFERENCE

10588000

#### EAN CODE



### 12 PERSONNES MAXIMUM - 10 PERSONS MAXIMUM

L2400 x 11700 mm - E19 mm - 217 kg  
L94.50" x W66.93" - T0.75" - 477.40 pounds

10588100



# TABLES - TABLES

## CHÊNE

Ø Dalles : 1200 - 1300 - 1400 mm / Ø Table tops: 47.24" - 51.18" - 55.12"



Ø 780 mm / 30.71"

264 kg / 582.02 pounds

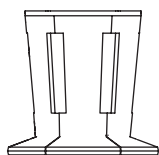

### TABLE SANS DALLE

Hauteur x Diamètre - Poids :  
751 x 780 mm - 190 kg

### TABLE WITHOUT TABLE TOP

Height x Diameter - Weight:  
29.57" x 30.71" - 418.88 pounds

### FINITION / FINISHING



CRISTAL INCOLORE  
CLEAR CRYSTAL

### REFERENCE

1031100

### EAN CODE



1951 - Marc Lalique

Détails techniques et instructions de montage : cf fiche architecture. / Technical datas & mounting instructions: see architecture files.

Table livrée sans dalle. / Table delivered without table top.

### DALLES / TABLE TOPS

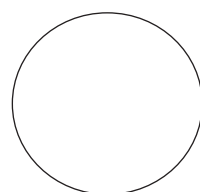

#### 4 PERSONNES MAXIMUM - 4 PERSONS MAXIMUM

Ø 1200 mm - E19 mm - 43 kg  
Ø 47.24" - T0.75" - 94.8 pounds

10587300



#### 6 PERSONNES MAXIMUM - 6 PERSONS MAXIMUM

Ø 1300 mm - E19 mm - 50 kg  
Ø 51.18" - T0.75" - 110.23 pounds

10587400



#### 6 PERSONNES MAXIMUM - 6 PERSONS MAXIMUM

Ø 1400 mm - E19 mm - 74 kg  
Ø 55.12" - T0.75" - 163.14 pounds

10587500



# TABLES - TABLES

COUTARD  
 RECTANGULAIRE / *RECTANGULAR*  
 CARRÉE / *SQUARE*  
 ÉDITION NUMÉROTÉE / *NUMBERED EDITION*

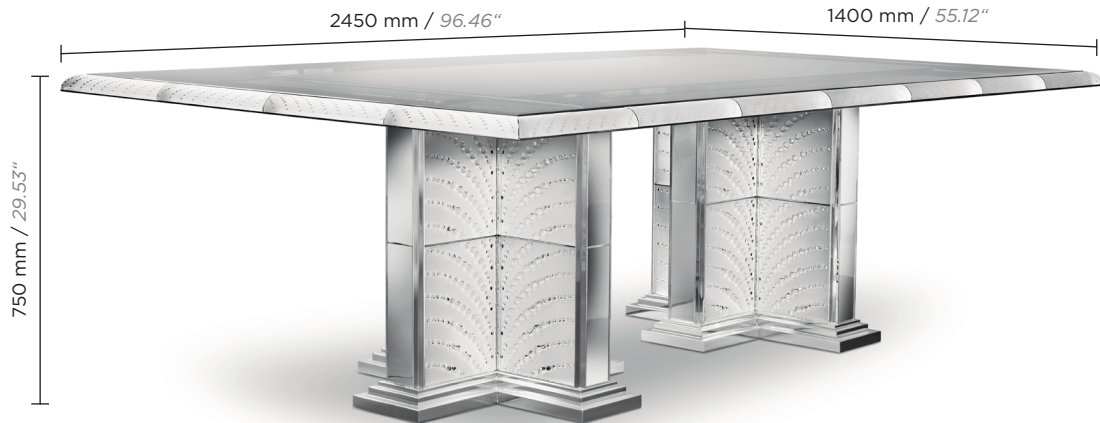

425 kg / 936.96 pounds  
**Rectangulaire / Rectangular**

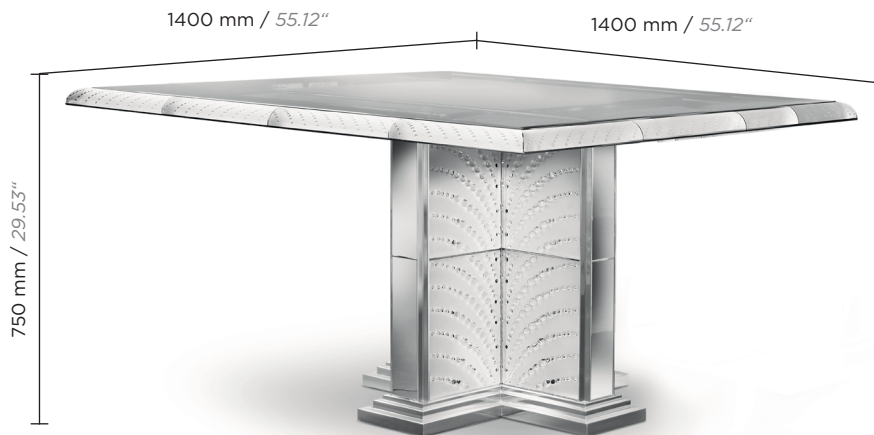

250 kg / 520.30 pounds  
**Carrée / Square**

FINITION / *FINISHING*

REFERENCE

EAN CODE



**10 PERSONNES MAXIMUM - 10 PERSONS MAXIMUM**  
 CRISTAL INCOLORE - *CLEAR CRYSTAL*

1061100



**Rectangulaire / Rectangular**



**4 PERSONNES MAXIMUM - 4 PERSONS MAXIMUM**  
 CRISTAL INCOLORE - *CLEAR CRYSTAL*

1061100



**Carrée / Square**



**4 PERSONNES MAXIMUM - 4 PERSONS MAXIMUM**  
**ÉCLAIRÉE - *LIGHTED***  
 CRISTAL INCOLORE - *CLEAR CRYSTAL*

10631600



2017 - PIERRE-YVES ROCHON POUR LALIQUE

# TABLES BASSES - COFFEE TABLES

## PERLES D'EAU / WATER PEARLS

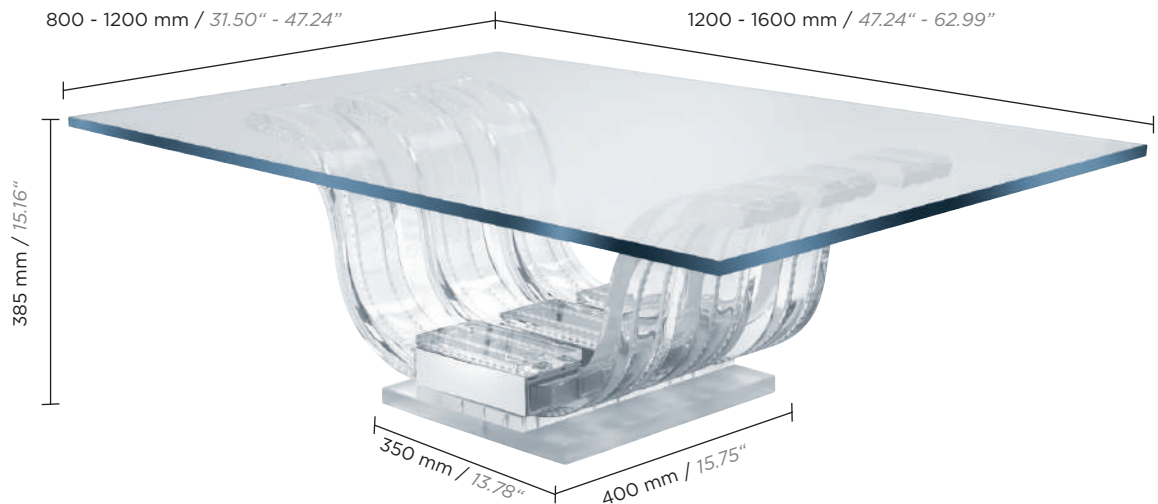
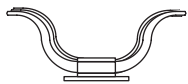

Table double / Double table



### TABLE SANS DALLE

Hauteur x Longueur x Largeur - Poids :  
370 x 915 x 400 mm - 50 kg

### TABLE WITHOUT TABLE TOP

Height x Length x Width - Weight:  
14.57" x 36.02" x 15.75" - 110.23 pounds

### FINITION / FINISHING



CRISTAL INCOLORE  
CLEAR CRYSTAL

### REFERENCE

1030300

### EAN CODE



1990 - Marie-Claude Lalique

Détails techniques et instructions de montage : cf fiche architecture. / Technical datas & mounting instructions: see architecture files.

Table livrée sans dalle. / Table delivered without table top.

PIED DE TABLE LIVRÉ À L'UNITÉ. COMMANDER DEUX PIEDS POUR UNE TABLE DOUBLE.

TABLE FOOT DELIVERED INDIVIDUALLY. TWO FOOT MUST BE ORDERED FOR A DOUBLE TABLE.

### DALLES / TABLE TOPS

### REFERENCE

### EAN CODE



#### DALLE SIMPLE - SINGLE TABLE TOP

L1200 X l800 mm - E15 mm - 36 kg  
L47.24" x W31.50" - T0.59" - 79.37 pounds

10587800



#### DALLE DOUBLE - DOUBLE TABLE TOP

L1600 x l1200 mm - E15 mm - 72 kg  
L62.99" x W47.24" - T0.59" - 158.73 pounds

10587900



# TABLES BASSES - COFFEE TABLES

VERSAILLES



104,80 kg / 231.04 pounds



**PIED DE TABLE SANS DALLE**

Hauteur x Longueur x Largeur - Poids :  
380 x 230 x 230 mm - 12,70 kg par pied

**TABLE FOOT WITHOUT TABLE TOP**

Height x Length x Width - Weight:  
14.95" x 9.06" x 9.06" - 20 pounds per table foot

FINITION / FINISHING

REFERENCE

EAN CODE



CRISTAL INCOLORE  
CLEAR CRYSTAL

1031400



2006 - LALIQUE

Détails techniques et instructions de montage : cf fiche architecture. / Technical datas & mounting instructions: see architecture files.

Table livrée sans dalle. / Table delivered without table top.

POUR TOUTE COMMANDE D'UNE TABLE BASSE VERSAILLES, MERCI DE COMMANDER 4 FOIS LA RÉFÉRENCE DU PIED DE TABLE 1031400.

FOR EVERY ORDER OF A VERSAILLES COFFEE TABLE, PLEASE ORDER 4 TIMES THE REFERENCE OF THE TABLE FOOT: 1031400.

DALLES / TABLE TOPS

REFERENCE

EAN CODE



L1200 x l1200 mm - E15 mm - 54 kg  
L47.24" x W47.24" - T0.59" - 119.05 pounds

10588500



L1200 x l1200 mm - E15 mm - 54 kg  
L47.24" x l47.24" - T0.59" - 119.05 pounds

0131200





# VANITY - VANITY

## CAUSEUSES

ÉDITION NUMÉROTÉE / *NUMBERED EDITION*

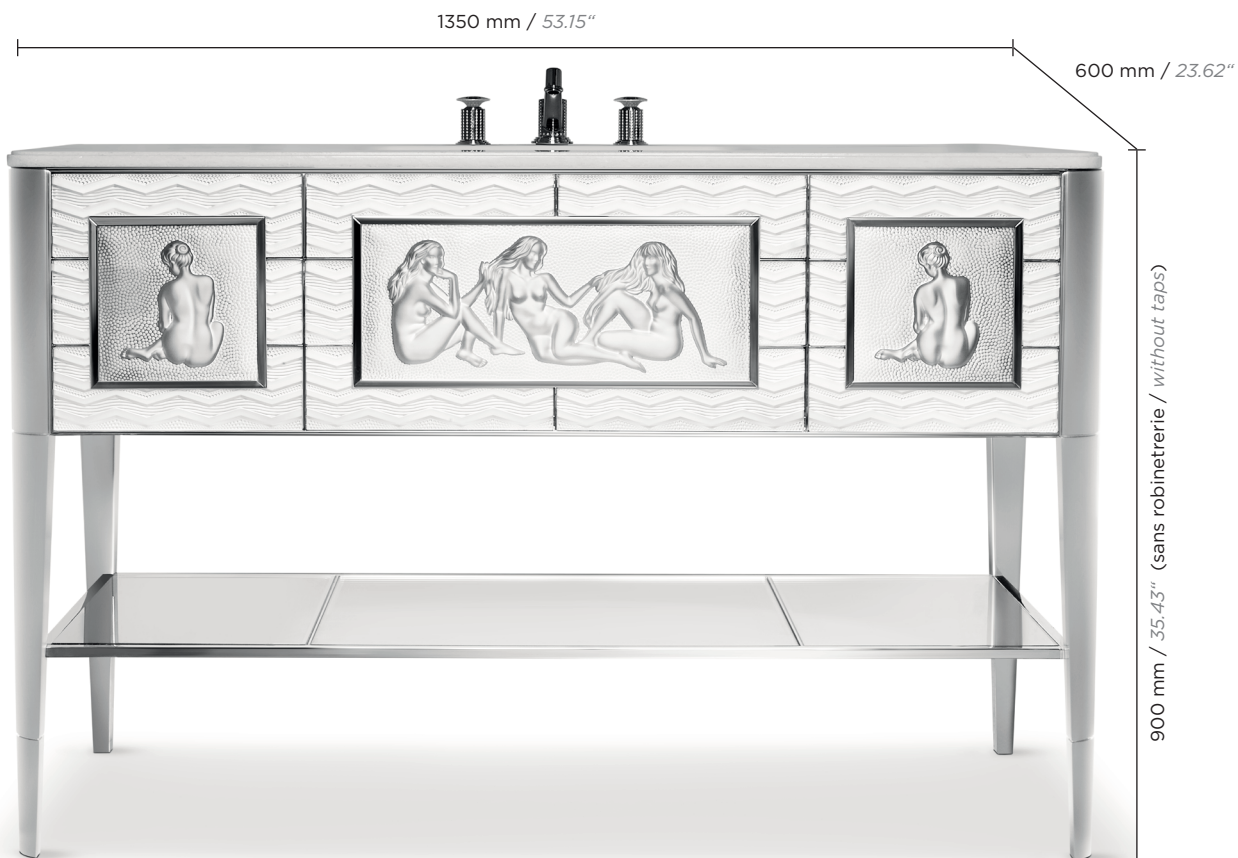

250 kg / 551.16 pounds

FINITION / *FINISHING*

REFERENCE

EAN CODE

**AVEC TIROIRS**  
*WITH DRAWERS*

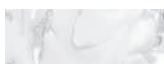

CRISTAL INCOLORE - *CLEAR CRYSTAL*  
NICKEL BRILLANT - *BRIGHT NICKEL*  
MARBRE BLANC - *WHITE MARBLE*

10637700



2017 - PIERRE-YVES ROCHON POUR LALIQUE



ASSISES - SEATINGS

# CHAISES CONTEMPORAINES - CONTEMPORARY CHAIRS

## COUTARD

AVEC CRISTAL ENCHÂSSÉ / WITH ADORNED CRYSTAL

ÉDITION NUMÉROTÉE / NUMBERED EDITION



16 kg / 35.27 pounds

Nickel / Nickel



Noyer teinté / Tinted walnut

### FINITION / FINISHING

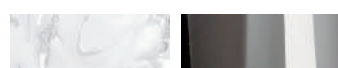

CRISTAL INCOLORE - CLEAR CRYSTAL  
CUIR - LEATHER  
NICKEL - NICKEL

### REFERENCE

10644100

### EAN CODE



CRISTAL INCOLORE - CLEAR CRYSTAL  
CUIR - LEATHER  
NOYER TEINTÉ - TINTED WALNUT

10644200



2018 - PIERRE-YVES ROCHON POUR LALIQUE

# CHAISES CONTEMPORAINES - CONTEMPORARY CHAIRS

COUTARD

ÉDITION NUMÉROTÉE / NUMBERED EDITION



Incolore / Clear  
Hêtre laqué bronze / Bronze lacquered beech

FINITION / FINISHING

REFERENCE

EAN CODE



CRISTAL INCOLORE - CLEAR CRYSTAL  
CUIR - LEATHER  
HÊTRE LAQUÉ MÉTAL - METAL LACQUERED BEECH

10644300



CRISTAL INCOLORE - CLEAR CRYSTAL  
SOIE - SILK  
HÊTRE LAQUÉ BRONZE - BRONZE LACQUERED BEECH

10644400



CRISTAL INCOLORE - CLEAR CRYSTAL  
CUIR - LEATHER  
HÊTRE LAQUÉ NOIR - BLACK LACQUERED BEECH

10644500



2018 - PIERRE-YVES ROCHON POUR LALIQUE



AUTRE MOBILIER - *OTHER FURNITURE*



LES CAUSEUSES



499 mm / 19.65"

25 kg / 55.12 pounds

MM, CENTRAL / MS, CENTRAL

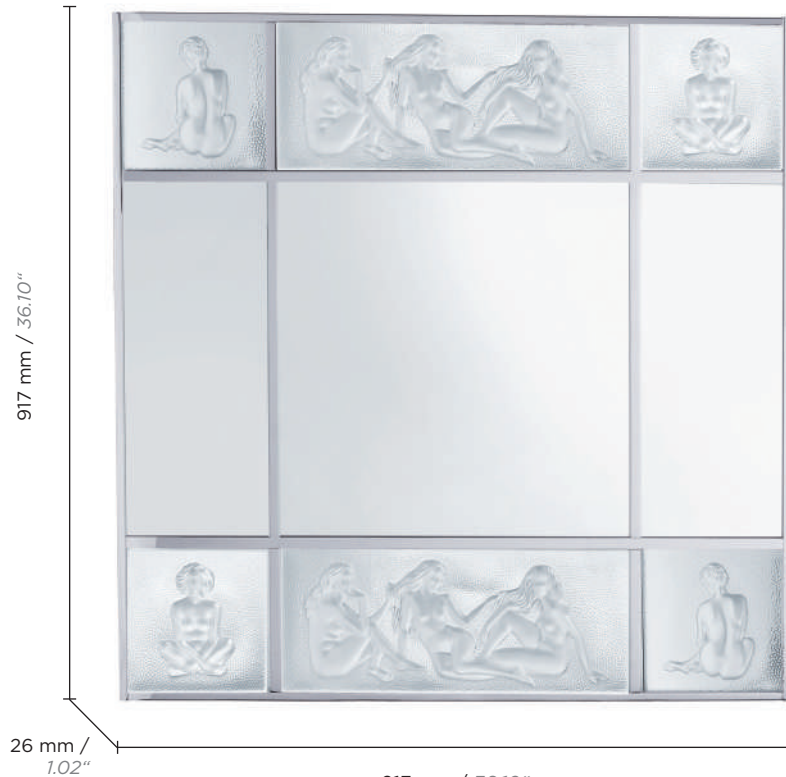

26 mm / 1.02"

917 mm / 36.10"

50 kg / 110.23 pounds

GM / LS

FINITION / FINISHING

REFERENCE

EAN CODE



CRISTAL INCOLORE - CLEAR CRYSTAL  
CHROMÉ - CHROME

1021500



MM, CENTRAL / MS, CENTRAL



CRISTAL INCOLORE - CLEAR CRYSTAL  
CHROMÉ - CHROME

1021400



GM / LS

1991 - Marie-Claude Lalique

Détails techniques et instructions de montage : cf fiche architecture. / Technical datas & mounting instructions: see architecture files.

Équerres murales de fixation apparentes. / Visible fixing wall brackets.

MERLES ET RAISINS

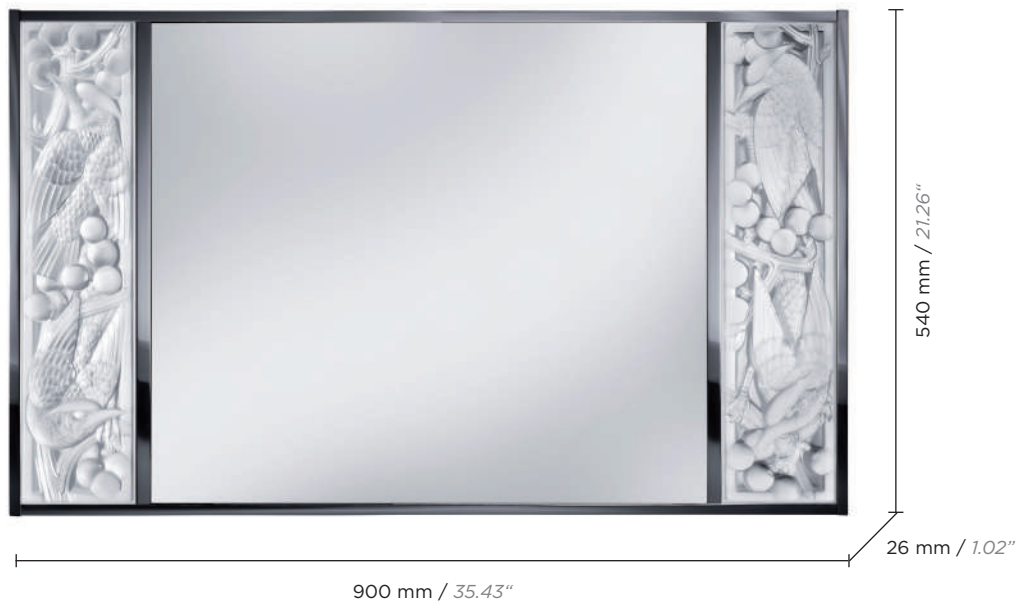

25 kg / 55.12 pounds

FINITION / FINISHING

REFERENCE

EAN CODE



CRISTAL INCOLORE - *CLEAR CRYSTAL*  
CHROMÉ - *CHROME*

10364400



0 90592 92305 4

2014 - LALIQUE

Détails techniques et instructions de montage : cf fiche architecture. / *Technical datas & mounting instructions: see architecture files.*

Équerres murales de fixation non apparentes. / *Invisible fixing wall brackets.*



OCÉANIA



Ø 860 mm / 33.86"

37 kg / 81.57 pounds

FINITION / FINISHING

REFERENCE

EAN CODE



CRISTAL INCOLORE  
CLEAR CRYSTAL

1021900



2001 - LALIQUE

Détails techniques et instructions de montage : cf fiche architecture. / *Technical datas & mounting instructions: see architecture files.*

**Équerres murales de fixation non apparentes. / *invisible fixing wall brackets.***

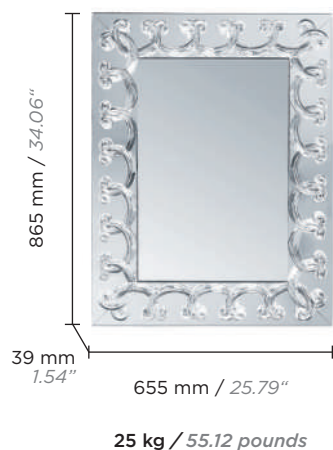

**PM / SS**



**TOUTE HAUTEUR / FULL LENGTH**



**GM / LS**

FINITION / FINISHING

REFERENCE

EAN CODE

**PM / SS**



1950 - Marc Lalique

CRISTAL INCOLORE  
CLEAR CRYSTAL

1020800



**GM / LS**



1950 - Marc Lalique

CRISTAL INCOLORE  
CLEAR CRYSTAL

1021300



**TOUTE HAUTEUR /  
FULL LENGTH**



1950 - Marc Lalique

CRISTAL INCOLORE  
CLEAR CRYSTAL

1021800



Détails techniques et instructions de montage : cf fiche architecture. / Technical datas & mounting instructions: see architecture files.  
Équerres murales de fixation non apparentes. / Invisible fixing wall brackets.

# POIGNÉES DE PORTE ET BOUTONS - *DOOR HANDLES AND KNOBS*

## FAUNES

### POIGNÉES DE PORTE / *DOOR HANDLES*

#### PORTE EN BOIS - *WOOD DOOR*



**1 FACE**  
*1 SIDE*



**2 FACES**  
*2 SIDES*

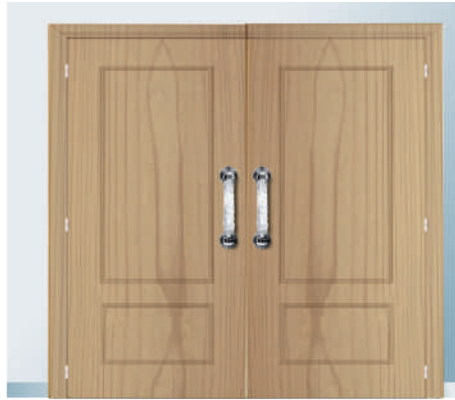

**DOUBLE PORTE EN BOIS - 1 FACE :**  
commander la référence : 1028450 x2 ou 1028750 x2  
**DOUBLE PORTE EN BOIS - 2 FACES :**  
commander la référence : 1028450 x4 ou 1028750 x4

*DOUBLE WOOD DOOR - 1 SIDE:*  
ordering reference: 1028450 x2 or 1028750 x2  
*DOUBLE WOOD DOOR - 2 SIDES:*  
ordering reference: 1028450 x4 or 1028750 x4



**SIMPLE PORTE EN BOIS - 1 FACE :**  
commander la référence : 1028450 x1 ou 1028750 x1  
**SIMPLE PORTE EN BOIS - 2 FACES :**  
commander la référence : 1028450 x2 ou 1028750 x2

*SINGLE WOOD DOOR - 1 SIDE:*  
ordering reference: 1028450 x1 or 1028750 x1  
*SINGLE WOOD DOOR - 2 SIDES:*  
ordering reference: 1028450 x2 or 1028750 x2

#### PORTE EN BOIS ET MIROIR *WOOD AND MIRROR DOOR*



**1 FACE**  
*1 SIDE*



**2 FACES**  
*2 SIDES*

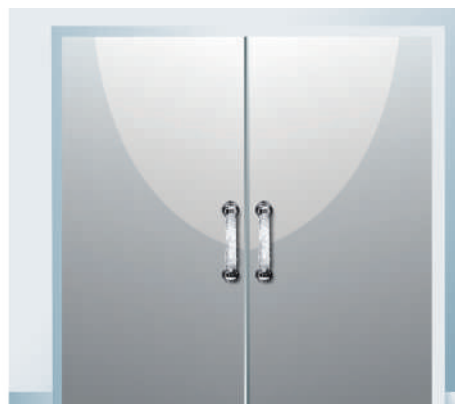

**DOUBLE PORTE EN BOIS ET MIROIR - 1 FACE :**  
commander la référence : 1028490 x2 ou 1028790 x2  
**DOUBLE PORTE EN BOIS ET MIROIR - 2 FACES :**  
commander la référence : 1028490 x4 ou 1028790 x4

*DOUBLE WOOD AND MIRROR DOOR - 1 SIDE:*  
ordering reference: 1028490 x2 or 1028790 x2  
*DOUBLE WOOD AND MIRROR DOOR - 2 SIDES:*  
ordering reference: 1028490 x4 or 1028790 x4



**SIMPLE PORTE EN BOIS ET MIROIR - 1 FACE :**  
commander la référence : 1028490 x1 ou 1028790 x1  
**SIMPLE PORTE EN BOIS ET MIROIR - 2 FACES :**  
commander la référence : 1028490 x2 ou 1028790 x2

*SINGLE WOOD AND MIRROR DOOR - 1 SIDE:*  
ordering reference: 1028490 x1 or 1028790 x1  
*SINGLE WOOD AND MIRROR DOOR - 2 SIDES:*  
ordering reference: 1028490 x2 or 1028790 x2

#### PORTE EN VERRE - *GLASS DOOR*



**1 FACE**  
*1 SIDE*



**2 FACES**  
*2 SIDES*

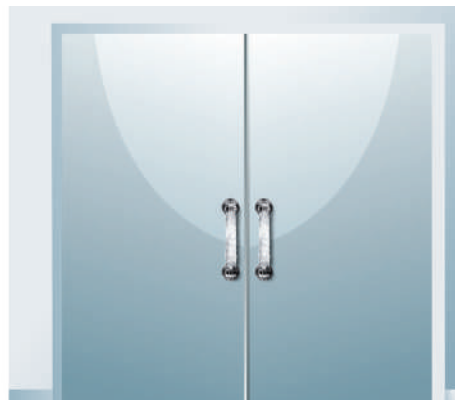

**DOUBLE PORTE EN VERRE - 1 FACE :**  
commander la référence : 1028400 x2 ou 1028700 x2  
**DOUBLE PORTE EN VERRE - 2 FACES :**  
commander la référence : 1028300 x2 ou 1028600 x2

*DOUBLE GLASS DOOR - 1 SIDE:*  
ordering reference: 1028400 x2 or 1028700 x2  
*DOUBLE GLASS DOOR - 2 SIDES:*  
ordering reference: 1028300 x2 or 1028600 x2

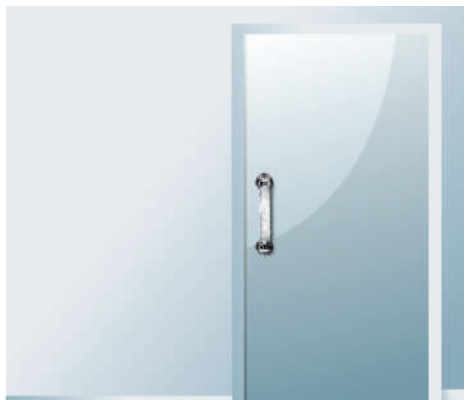

**SIMPLE PORTE EN VERRE - 1 FACE :**  
commander la référence : 1028400 x1 ou 1028700 x1  
**SIMPLE PORTE EN VERRE - 2 FACES :**  
commander la référence : 1028300 x1 ou 1028600 x1





























*SINGLE GLASS DOOR - 1 SIDE:*  
ordering reference: 1028400 x1 or 1028700 x1  
*SINGLE GLASS DOOR - 2 SIDES:*  
ordering reference: 1028300 x1 or 1028600 x1

# POIGNÉES DE PORTE ET BOUTONS - *DOOR HANDLES AND KNOBS*

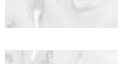
## FAUNES

### POIGNÉES DE PORTE / *DOOR HANDLES*



FINITION / <i>FINISHING</i>		REFERENCE	EAN CODE	
<b>PORTE SIMPLE EN BOIS - <i>WOOD SINGLE DOOR</i></b>				
 1 POIGNÉE 1 HANDLE	 	CRISTAL INCOLORE - <i>CLEAR CRYSTAL</i> CHROMÉ - <i>CHROME</i>	1028450	
	 	CRISTAL INCOLORE - <i>CLEAR CRYSTAL</i> DORÉ - <i>GILDED</i>	1028750	
<b>PORTE SIMPLE EN BOIS ET MIROIR - <i>WOOD AND MIRROR SINGLE DOOR</i></b>				
 1 POIGNÉE 1 HANDLE	 	CRISTAL INCOLORE - <i>CLEAR CRYSTAL</i> CHROMÉ - <i>CHROME</i>	1028490	
	 	CRISTAL INCOLORE - <i>CLEAR CRYSTAL</i> DORÉ - <i>GILDED</i>	1028790	
<b>PORTE SIMPLE EN VERRE - <i>GLASS SINGLE DOOR</i></b>				
 1 POIGNÉE 1 HANDLE	 	CRISTAL INCOLORE - <i>CLEAR CRYSTAL</i> CHROMÉ - <i>CHROME</i>	1028400	
	 	CRISTAL INCOLORE - <i>CLEAR CRYSTAL</i> DORÉ - <i>GILDED</i>	1028700	
 2 POIGNÉES FACE À FACE* 2 HANDLES FACE TO FACE*	 	CRISTAL INCOLORE - <i>CLEAR CRYSTAL</i> CHROMÉ - <i>CHROME</i>	1028300	
	 	CRISTAL INCOLORE - <i>CLEAR CRYSTAL</i> DORÉ - <i>GILDED</i>	1028600	

1962 - Marc Lalique

Détails techniques et instructions de montage : cf fiche architecture. / *Technical datas & mounting instructions: see architecture files.*

Épaisseur de la porte à préciser lors de la commande. / *Door thickness to be precised when ordering.*

\*Une poignée sur chaque face de la porte. / *\*One handle on each side of the door.*

# POIGNÉES DE PORTE ET BOUTONS - *DOOR HANDLES AND KNOBS*

## BUCOLIQUE

BOUTONS / *KNOBS*



### FINITION / *FINISHING*

### REFERENCE

### EAN CODE



CRISTAL INCOLORE - *CLEAR CRYSTAL*  
CHROMÉ - *CHROME*

1034000



CRISTAL INCOLORE - *CLEAR CRYSTAL*  
DORÉ - *GILDED*

10346600



2007 - LALIQUE

Détails techniques et instructions de montage : cf fiche architecture. / *Technical datas & mounting instructions: see architecture files.*

# POIGNÉES DE PORTE ET BOUTONS - *DOOR HANDLES AND KNOBS*

## MASQUE DE FEMME

BOUTONS / *KNOBS*

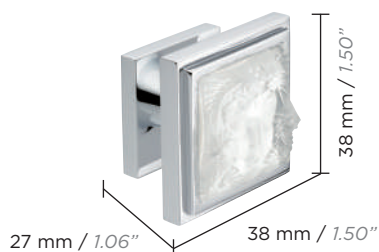

MM / MS

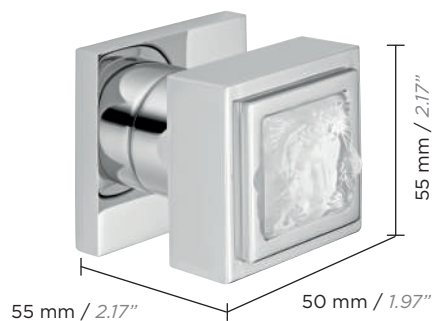

GM / LS

### FINITION / FINISHING

### REFERENCE

### EAN CODE



CRISTAL INCOLORE  
CLEAR CRYSTAL  
CHROME - CHROME

10173100



CRISTAL INCOLORE  
CLEAR CRYSTAL  
DORÉ - GILDED

10173200



**1 BOUTON MM - 1 MS KNOB**



CRISTAL INCOLORE  
CLEAR CRYSTAL  
CHROME - CHROME

10172700



CRISTAL INCOLORE  
CLEAR CRYSTAL  
DORÉ - GILDED

10172800



**1 BOUTON GM - 1 LS KNOB**

2011 - LALIQUE & THG

Détails techniques et instructions de montage : cf fiche architecture. / *Technical datas & mounting instructions: see architecture files.*

# POIGNÉES DE PORTE ET BOUTONS - *DOOR HANDLES AND KNOBS*

## MÉTROPOLIS

BOUTONS / *KNOBS*

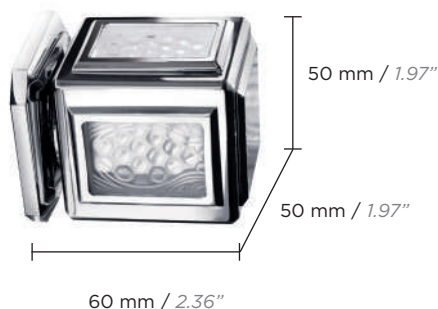
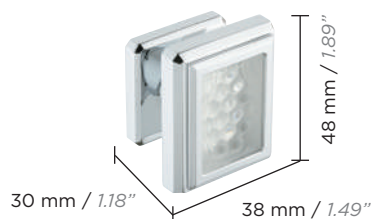

0,22 kg / 0.49 pounds

0,90 kg / 1.98 pounds

MM / MS

GM / LS

FINITION / *FINISHING*

REFERENCE

EAN CODE



CRISTAL INCOLORE  
*CLEAR CRYSTAL*  
CHROME - *CHROME*

1033500



CRISTAL INCOLORE  
*CLEAR CRYSTAL*  
DORÉ - *GILDED*

1033510



1 BOUTON MM - 1 MS *KNOB*



CRISTAL INCOLORE  
*CLEAR CRYSTAL*  
CHROME - *CHROME*

1033100



CRISTAL INCOLORE  
*CLEAR CRYSTAL*  
DORÉ - *GILDED*

1033110



1 BOUTON GM - 1 LS *KNOB*

2006 - LALIQUE & THG

Détails techniques et instructions de montage : cf fiche architecture. / *Technical datas & mounting instructions: see architecture files.*

## PERLES BOUTONS / *KNOBS*

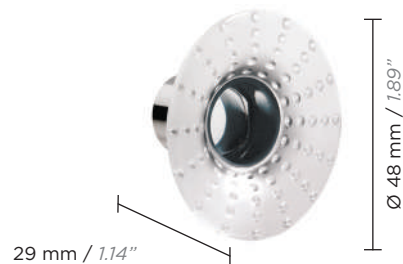

0,06 kg / 0.13 pounds

FINITION / *FINISHING*

REFERENCE

EAN CODE



CRISTAL INCOLORE - *CLEAR CRYSTAL*  
CHROMÉ - *CHROME*

1034100



0 90592 08125 9

2007 - LALIQUE

Détails techniques et instructions de montage : cf fiche architecture. / *Technical datas & mounting instructions: see architecture files.*





PANNEAUX DÉCORATIFS &  
PANNEAUX D'ESPACE -  
*DECORATIVE PANELS &  
INTERIOR PANELS*



1.

PANNEAUX DÉCORATIFS  
*DECORATIVE PANELS*

# PANNEAUX DÉCORATIFS - *DECORATIVE PANELS*

## I. MISES EN OEUVRE DES PANNEAUX DÉCORATIFS / *INSTALLATION OF THE DECORATIVE PANELS*

### 1 - MIS EN OEUVRE DIRECTEMENT PAR LE CLIENT / *INSTALLATION DIRECTLY BY THE CLIENT:*

- Il peut s'agir d'un panneau miroité ou non miroité seul.
  - Le client reçoit des panneaux décoratifs dans leur conditionnement.
  - LALIQUE n'intervient pas dans le process de montage ni sur la mise en oeuvre.
  - Tolérance des dimensions de +/- 2 mm, une tolérance plus précise (+/- 1 mm) peut être obtenue sur demande et sur devis.
- *Mirrored or non-mirrored panel.*
  - *The client receives the decorative panels in their packaging.*
  - *LALIQUE is not involved in the mounting process and does not provide guidances for the installation.*
  - *Dimensions may vary between +/-2 mm. More precise dimensions can be achieved on demand and quotation.*



Panneau de cristal miroité ou non miroité  
*Crystal panel mirrored or non-mirrored*

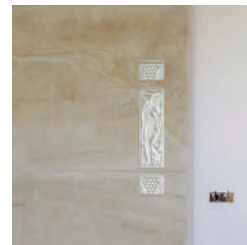

### 2 - MISE EN OEUVRE DANS UNE MONTURE LALIQUE / *IMPLEMENTATION IN A LALIQUE MOUNT:*

- Il s'agit d'un panneau miroité ou non-miroité mis en monture par LALIQUE.
  - Le client reçoit des panneaux décoratifs dans leur conditionnement avec la monture métallique associée, à monter sur place ou déjà montée, selon les projets.
  - La monture permet de combiner plusieurs panneaux ensemble.
  - La monture LALIQUE présente l'avantage de rattraper les différences d'épaisseur des panneaux.
- *Mirrored or non-mirrored panel in a LALIQUE mount.*
  - *The client receives the decorative panels including the associated metallic mount which has to be mounted on the spot or is already mounted, depending on the project.*
  - *The mount allows the combining of various panels together.*
  - *The LALIQUE mount makes up for the possible difference of thickness to one panel from another.*



Panneau de cristal miroité ou non miroité  
*Crystal panel mirrored or non-mirrored*

Monture / *Mount*



### 3 - MISE EN OEUVRE EN PANNEAU D'ESPACE / *IMPLEMENTATION OF AN INTERIOR PANEL:*

- Il s'agit de panneaux de verre extra-blancs aux formats et dimensions sur-mesure contenant des panneaux de cristal et/ou des motifs sablés à la main.
  - Le panneau d'espace permet d'étendre la surface du panneau de cristal tout en conservant la transparence. Cela rend possible l'intégration d'une composition de grande dimensions d'un seul tenant.
  - La précision des dimensions facilite l'intégration dans un contexte architectural.
  - Le collage UV est une opération irréversible.
  - Voir chapitre panneaux d'espace pour plus de détails.
- *Panels with extra-white glass in bespoke formats and sizes, including crystal panels and/or by hand sandblasted motifs.*
  - *The interior panel allows extending the crystal panel while maintaining the transparency. This makes it possible to integrate a large size composition in one piece.*
  - *The precision of the dimensions facilitates integration in an architectural context.*
  - *UV gluing is an irreversible operation.*
  - *For more details, please refer to the interior panels chapter.*



Panneau de cristal non miroité collé UV sur une dalle en verre  
*Non mirrored crystal panel, UV glued on a glass slab*

Supprt en verre / *Glass mount*



# PANNEAUX DÉCORATIFS - *DECORATIVE PANELS*

## II. LES ÉTAPES DE FABRICATION D'UN PANNEAU DÉCORATIF

### *STEP BY STEP MANUFACTURING PROCESS OF A DECORATIVE PANEL*

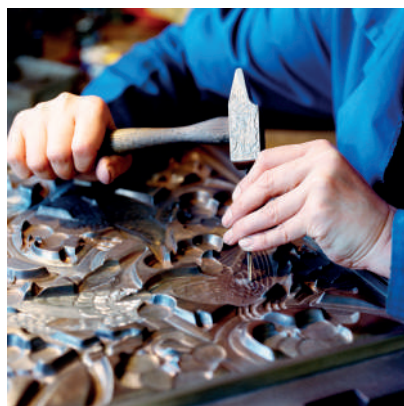

Chaque panneau est fabriqué artisanalement selon la technique du pressé. Pour chaque panneau, un moule en fonte est fabriqué.

Les dimensions de chaque panneau sont conditionnées par les dimensions du moule correspondant.

**La taille des panneaux ne peut être modifiée sans refaire un nouveau moule.**

*Each panel is handcrafted according to the pressing technique. A cast-iron mold is manufactured for each panel. The dimensions of each panel are related to the dimensions of the corresponding mold.*

***The size of the panel cannot be modified without manufacturing a new mold.***

### 1 - VERRE CHAUD / *HOT GLASS:*

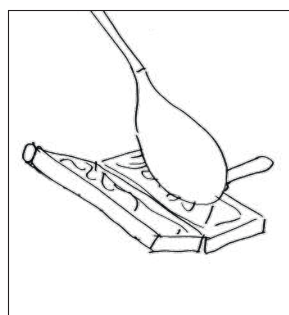

Cristal en fusion cueilli et coulé dans le moule  
*Melted crystal is gathered and cast into the mold*

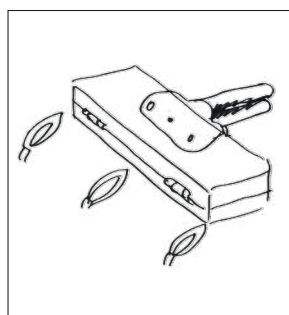

Le moule est pressé  
*The mold is pressed*

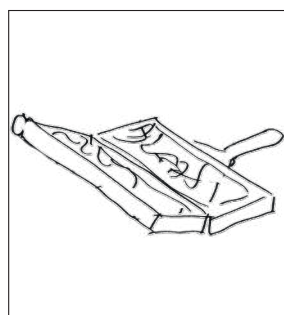

Le panneau est démoulé  
*The panel is taken out of the mold*

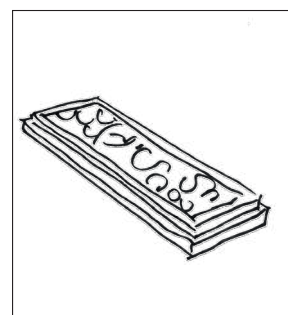

Le panneau est recuit (refroidissement contrôlé)  
*The panel is annealed. (controlled cooling off)*

### 2 - VERRE FROID / *COLD GLASS:*

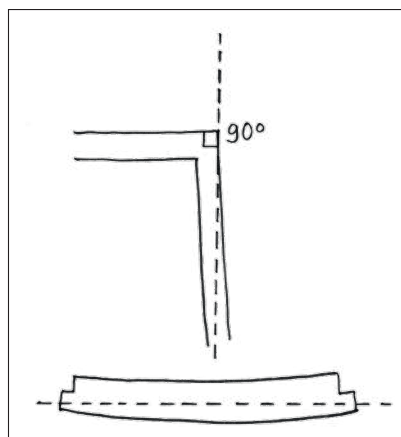

Travail sur la géométrie du panneau.  
Tolérance variable en raison du caractère artisanal du processus de fabrication  
*There can be variance due to the craftsmanship in the process*

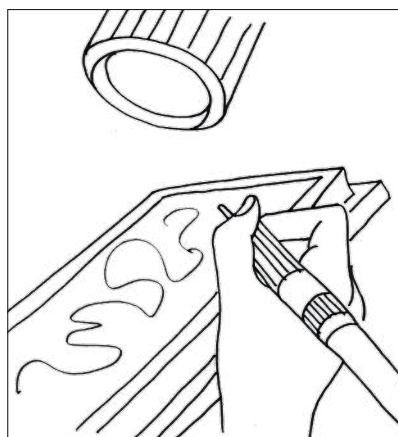

Travail sur la finition du motif  
*Finishing of the design*

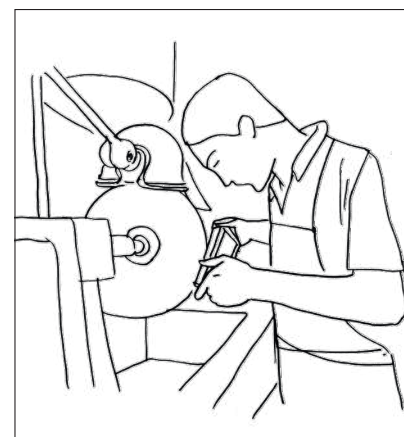

Travail sur l'éclat et la finition du cristal  
*Polishing of the crystal*

De nombreuses autres opérations au verre froid peuvent être réalisées : émaillage, tamponnage, etc.

La non-planéarité fait partie inhérente du processus artisanal de fabrication et ne peut être considérée comme un défaut.

*Several other operations can be completed in the cold glass workshop: enamelling, stamping etc.*

*The fact that the panels are not completely even is part of the handmade process and cannot be considered as defect.*

# PANNEAUX DÉCORATIFS - *DECORATIVE PANELS*

## III. FORMATS ET DIMENSIONS POSSIBLES / *AVAILABLE SIZES*

### 1 - FORMATS DES PANNEAUX EXISTANTS (notion d'échelle)

*FORMATS OF EXISTING PANELS (notions of scale):*



Madison panel  
H 182 / L 166 mm  
H 7.17" / L 6.54"  
0.77 kg / 1.70 pounds



Aster panel  
H 290 / L 290 mm  
H 11.42" / L 11.42"  
2.20 kg / 4.85 pounds

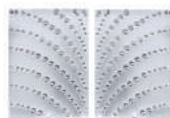

Coutard panel left or right  
H 319 / L 235 mm  
H 12.56" / L 9.25"  
3.80 kg / 8.38 pounds



Lauriers panel  
H 433 / L 374 mm  
H 17.05" / L 14.72"  
7.50 kg / 16.53 pounds



Joueur de pipeau panel  
left or right  
H 458 / L 153 mm  
H 18.03" / L 6.02"  
2.80 kg / 6.17 pounds

### 2 - UTILISATION D'UN PANNEAU DÉCORATIF POUR COUVRIR UN MUR (principe général)

*USE OF A DECORATIVE PANEL TO COVER A WALL (general principle):*

Panneau décoratif Lauriers  
Dimensions fixes 37 x 43 cm  
*Lauriers decorative panel  
Fixed dimensions 14.72" x 17.05"*

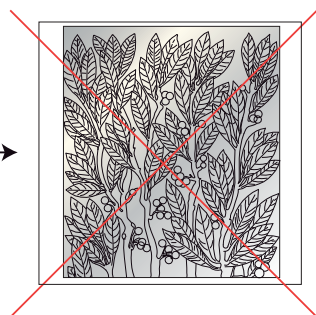

Pas d'agrandissement  
du panneau envisageable sans  
refaire un nouveau moule.  
*It is not possible to enlarge an  
existing crystal panel without  
producing a new cast mold.*

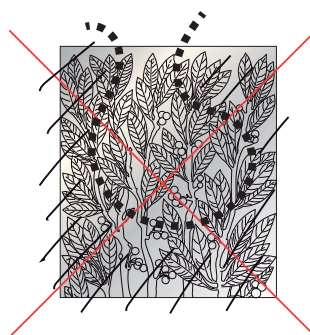

Découpe dans le panneau  
impossible (découpe parfois  
possible après étude).  
*It's not always  
possible to cut in a crystal  
panel.*

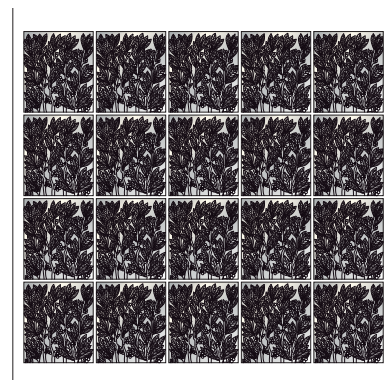

Pour couvrir la surface d'un mur, il faut  
assembler plusieurs panneaux.  
*To cover a wall surface, several panels  
have to be assembled.*

# PANNEAUX DÉCORATIFS - *DECORATIVE PANELS*

## IV. FINITIONS ESTHÉTIQUES DES PANNEAUX DÉCORATIFS *FINISHINGS AESTHETICS OF DECORATIVE PANELS*

### 1 - NON MIROITÉ / *NON MIRRORED*



Panneau Lauriers  
*Lauriers panel*



#### **Exemple de mise en oeuvre :**

Panneaux d'espace composés de panneaux Lauriers collés UV sur une dalle de verre satinée en dégradé. L'ensemble est inséré dans les portes du restaurant le George, Hôtel le George V (monture des portes non fournies par LALIQUE).

#### **Example of installation:**

*Interior panels composed of Lauriers panels, UV glued on a gradient satin glass slab. These panels are inserted into the doors of the restaurant le George, Hôtel le George V in Paris (door frame not provided by LALIQUE).*

### 2 - MIROITÉ / *MIRRORED*



Panneau Lauriers  
*Lauriers panel*



#### **Exemple de mise en oeuvre :**

Panneaux Lauriers miroités insérés dans le meuble d'accueil du restaurant le George, Hôtel le George V (monture sur-mesure non fournie par LALIQUE).

#### **Example of installation:**

*Mirrored Lauriers panels inserted in the reception desk of the restaurant le George, Hôtel George V (custom-made mount, not provided by LALIQUE).*

### 3 - AUTRES FINITIONS SUR DEMANDE / *OTHER BESPOKE FINISHINGS*

Les panneaux de cristal peuvent faire l'objet de finitions esthétiques spécifiques sur demande. La faisabilité sera étudiée selon la demande.

*The panels can have specific aesthetics with customized finishing. The feasibility has to be studied based on the project.*

# PANNEAUX DÉCORATIFS - *DECORATIVE PANELS*

## V. FINITIONS TECHNIQUES DES PANNEAUX DÉCORATIFS

### *TECHNICAL FINISHINGS OF THE DECORATIVE PANELS*

Feuilleure : « Une feuilleure est une entaille pratiquée à moitié de l'épaisseur d'un panneau de cristal ».

*Rabbet: "A rabbet is a recess or a groove cut into the edge of the crystal panel."*

#### 1 - SANS FEUILLEURE / *WITHOUT RABBET*

##### Caractéristiques :

Un panneau sans feuilleure peut être mis en œuvre dans une monture ou collé UV dans le cadre d'un projet de panneau d'espace, sans modifications.

##### Features:

*A panel without rabbet can be integrated in a mount or UV glued as part of an interior panel project without any modifications.*

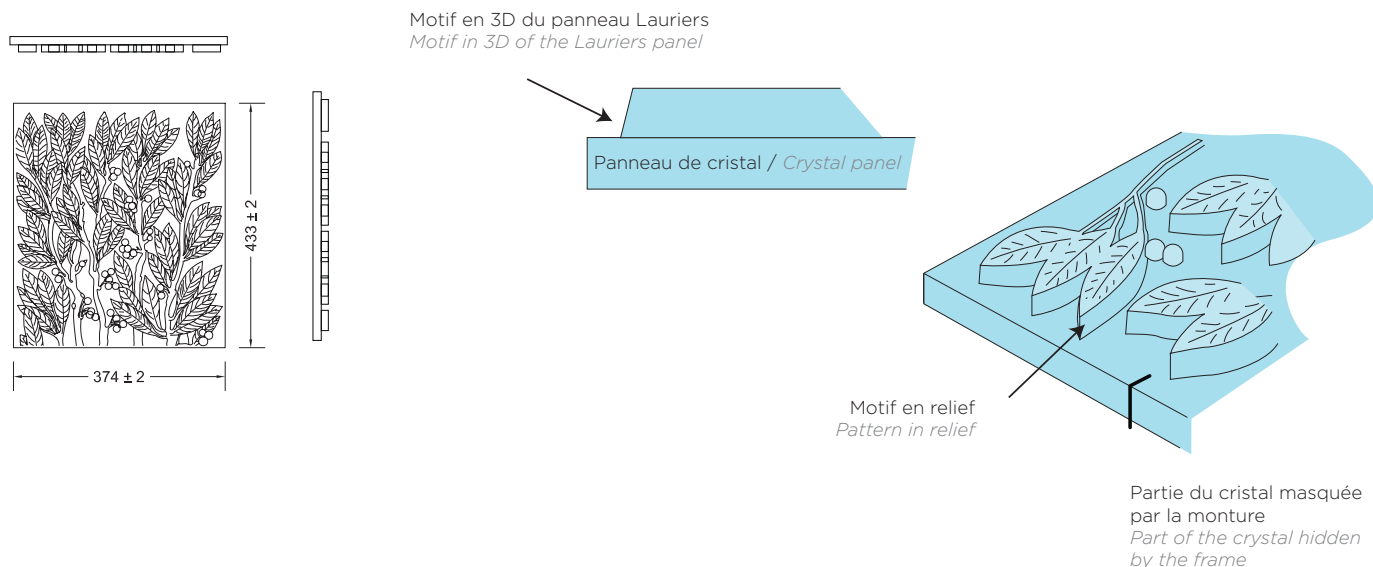

#### 2 - AVEC FEUILLEURE / *WITH RABBET*

##### Caractéristiques :

- Les dimensions du panneau incluent la feuilleure qui sera masquée dans la monture.
- La feuilleure est supprimée par une opération manuelle lorsque le panneau est collé UV dans le cadre d'un projet de panneau d'espace.

##### Features:

- *Panel dimensions include the rabbet which will be hidden in the frame.*
- *When the panels are UV glued as part of an interior panel project, the rabbet will be removed by a manual process.*

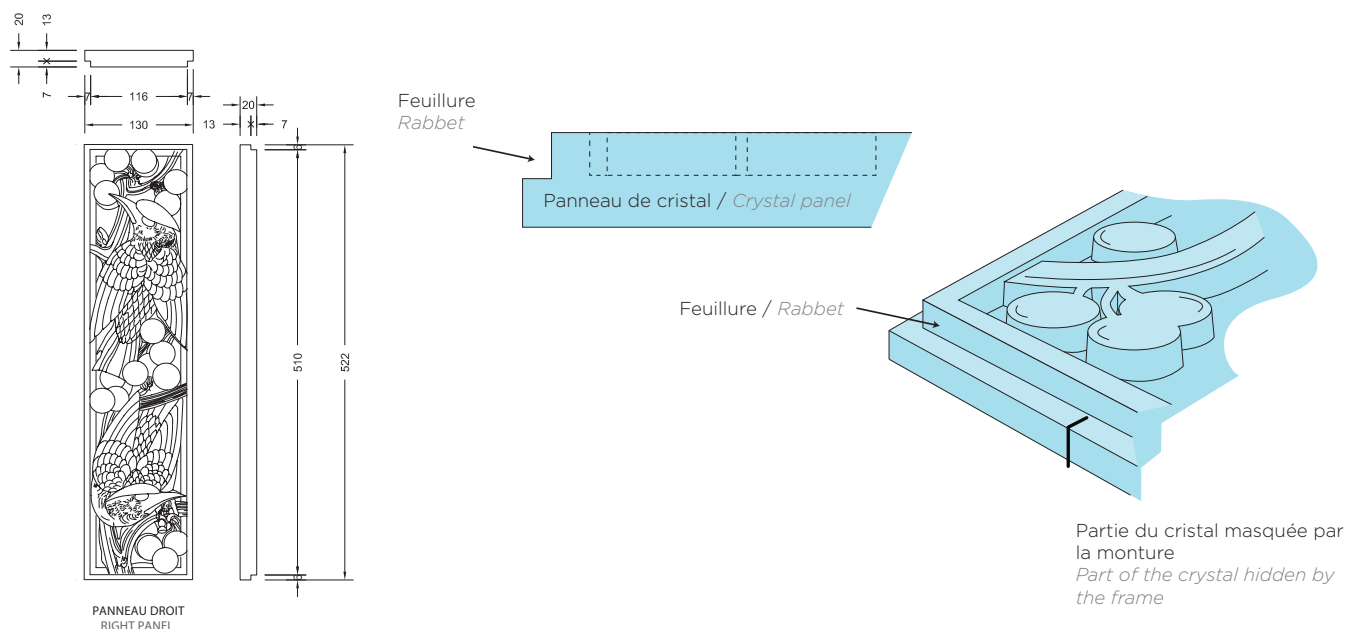



# PANNEAUX DÉCORATIFS - *DECORATIVE PANELS*

## VI. INTÉGRATION EN MONTURE ET EN LUMIÈRE DES PANNEAUX DÉCORATIFS *USING DECORATIVE PANELS IN FRAMES AND IN LIGHTS*

### 1 - LES MONTURES EN « L » ET EN « T » / *“L” AND “T” SHAPED FRAMES*

#### 1.1 - LA MONTURE EN « L » POUR ACCROCHAGE COMME UN TABLEAU *L-SHAPED FRAME TO BE HUNG LIKE A PICTURE*



Exemple d'une composition Merles et Raisins accrochée au mur comme un tableau avec une monture en L

Composition example Merles et Raisins (Blackbirds and Grapes) hung on the wall like a picture with an L-shaped frame

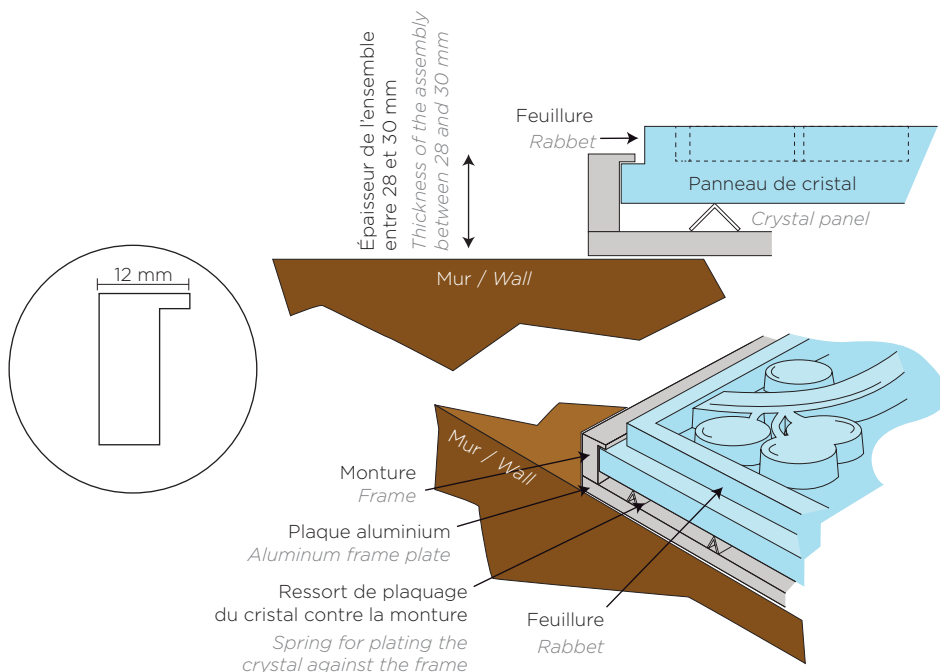

#### 1.2 - LA MONTURE EN « T » POUR ACCROCHAGE ENCASTRÉ DANS LE MUR *T-SHAPED FRAME FOR HANGING RECESSED INTO THE WALL*



Exemple d'un ensemble de panneaux Lauriers encastrés dans le mur avec une monture en T

Example of a set of Lauriers (laurel) panels recessed into the wall with a T-shaped frame

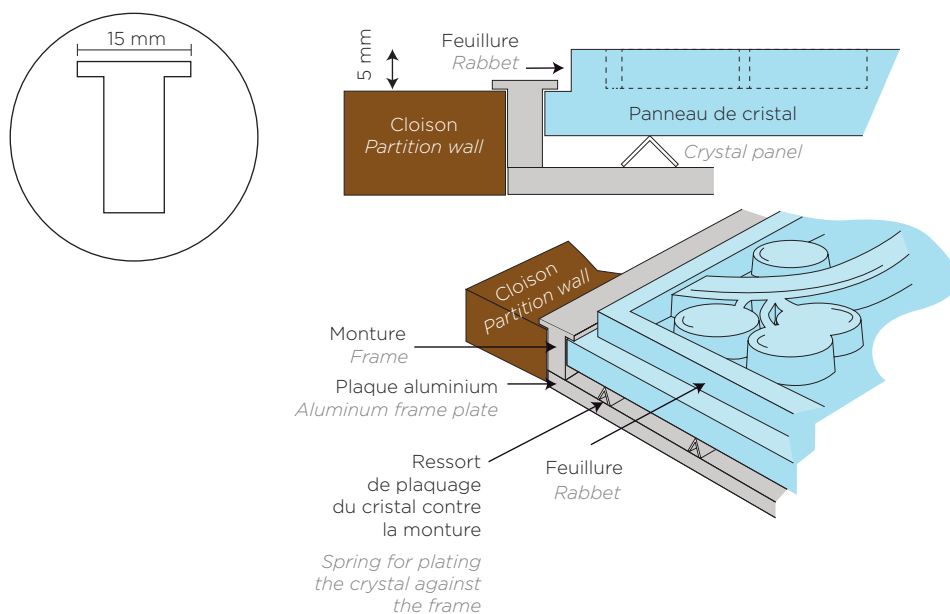

# PANNEAUX DÉCORATIFS - *DECORATIVE PANELS*

## VII. SUGGESTIONS D'INTÉGRATION / *SUGGESTIONS FOR INTEGRATION*

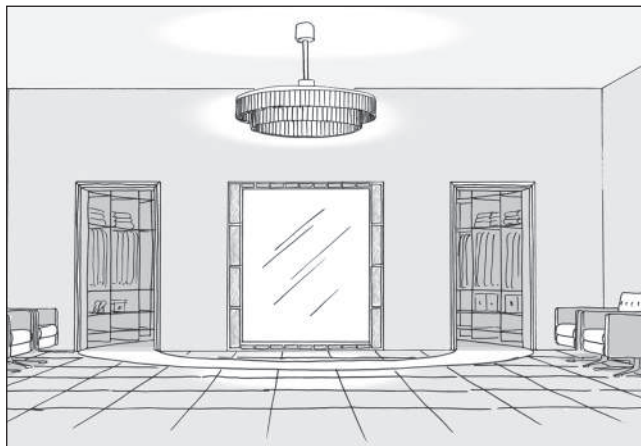

Frises de panneaux décoratifs entourant un miroir (miroir non fourni)  
*Friezes of decorative panels surrounding a mirror (mirror not provided)*

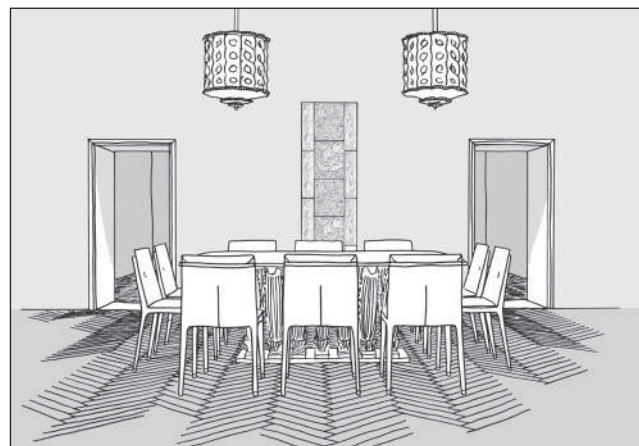

Composition XXL de panneaux décoratifs accrochée sur un mur  
*Grand composition of decorative panels hung on a wall*



Frises de panneaux décoratifs encadrant les portes d'une cave à vin  
*Friezes of decorative panels integrated in the doors of a wine cellar*



Panneaux Merles et Raisins insérés dans le bar et dans le mur  
*Merles et Raisins panels integrated in a bar and a wall*

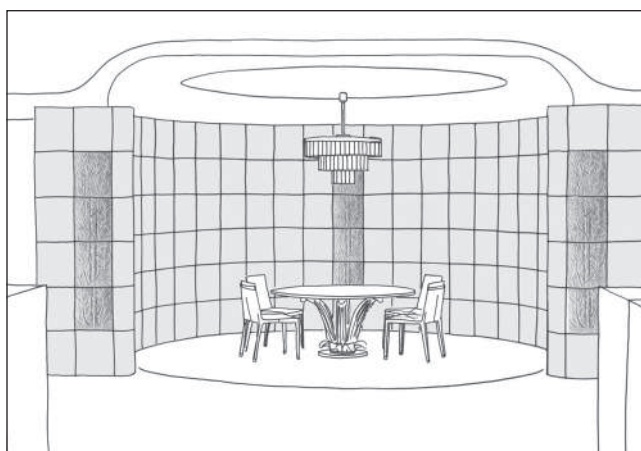

Ensembles de panneaux Lauriers dans l'entrée d'une maison privée  
*Sets of Lauriers panels at the entrance of a private house*



Ensembles de panneaux Coutard insérés sur des colonnes  
*Set of Coutard panels integrated in pillars*

## INFORMATIONS INDISPENSABLES À PRÉCISER POUR TOUTE DEMANDE DE PANNEAUX DÉCORATIFS :

Ces informations sont nécessaires pour la définition et l'étude de prix de la demande de panneaux décoratifs :

- I. Dimensions globales du projet
- II. Environnement d'intégration des panneaux décoratifs (contexte, type d'environnement, nature du support d'accrochage)
- III. Mise en œuvre des panneaux pour assemblage entre eux. En fonction du contexte et de l'une des 3 options de mise en œuvre souhaitée par le client, les questions suivantes s'appliquent :

### OPTION 1 : Mise en œuvre des panneaux par le client. LALIQUE FOURNIT les panneaux seuls :

- Choix du ou des panneau(x) décoratif(s) et quantité(s)
- Finition des panneaux (miroités ou non-miroités)
- Précisions sur la tolérance de géométrie des panneaux (définition d'un gabarit de contrôle entre le client et Lalique si nécessaire)
- Modification du panneau cristal selon les contraintes du projet du client (à confirmer par Lalique). Exemple : enlèvement de la feuillure, découpe dans le format original, affinement de l'épaisseur du panneau, etc. Toute modification après production du panneau génère obligatoirement un surcoût.

### OPTION 2 : Mise en œuvre des panneaux par LALIQUE en monture métal. LALIQUE FOURNIT la monture et les panneaux :

- Choix du ou des panneau(x) décoratif(s) et quantité(s)
- Finition de la monture souhaitée (échantillon à fournir si finition sur-mesure)
- Éclairage dans la monture (information à donner en amont du projet, contraintes techniques)
- Type d'accrochage souhaité (intégration, accrochage comme un tableau, etc.)

### OPTION 3 : Mise en œuvre des panneaux par LALIQUE en panneau d'espace :

- Choix du ou des panneau(x) décoratif(s) et quantité(s)
- Dimensions hors tout et épaisseur du panneau d'espace
- Dimensions du clair de vue (voir chapitre panneau d'espace)
- Finition(s) technique(s) du panneau d'espace (partie verre) : sécurisation, options du verre dont l'usinage (pour insert de charnières\* et de poignées de porte\*, etc.)
- Information sur la mise en lumière\* prévue par le client

\*Les systèmes lumineux, les montures, les charnières, les poignées de portes ou autres ne sont pas fournis par LALIQUE.

## ESSENTIAL INFORMATION REQUIRED FOR ANY DECORATIVE PANEL:

*The below information is required to develop the design and provide a quotation of a decorative panel:*

- I. Dimensions of the project*
- II. Installation type and usage of the panel (wall, mirror, door insert, etc.)*
- III. Panel installation options. Depending on one of the 3 installation options chosen by the client, the following questions apply:*

### **OPTION 1: Installation by the client directly. LALIQUE provides only the panels:**

- *Choice of the decorative panel(s) and amount*
- *Finishing of the panel (mirrored or non-mirrored)*
- *Confirming the geometrical shape of the panel (if necessary comparing to a template between the client and Lalique)*
- *Modification of the crystal panel according to the constraints of the client's project (to be confirmed by Lalique). Example: Removal of the rabbet, cutting of the original format, refinement of the thickness of the panel, etc. Any modification after production of the panel generates an additional cost.*

### **OPTION 2: Installation of the panels in a metallic mount. LALIQUE provides the mount and the panels:**

- *Choice of the decorative panel(s) and amount.*
- *Finishing of the preferred mount (if it is a bespoke finishing a sample will be produced)*
- *Lighting in the mount (information to be provided with the project, technical constraints)*
- *Preferred mounting type (integration, assembly like a board etc.)*

### **OPTION 3: Installation of LALIQUE panels as interior panels**

- *Choice of the decorative panel(s) and amount*
- *Overall dimensions and thickness of the interior panel*
- *Dimension of the inside measurement (refer to the interior panels chapter)*
- *Technical finishing(s) of the interior panel(s) (glass part): security, glass options therewith the using (for the insert of the hinges\* and door handles\*etc.)*
- *Information of the planned lighting\**

\* Lighting systems, mountings, drillings and handles are not provided by LALIQUE.

# PANNEAUX DÉCORATIFS - *DECORATIVE PANELS*

**COUTARD**

PANNEAU SANS FEUILLURE  
PANEL WITHOUT RABBET

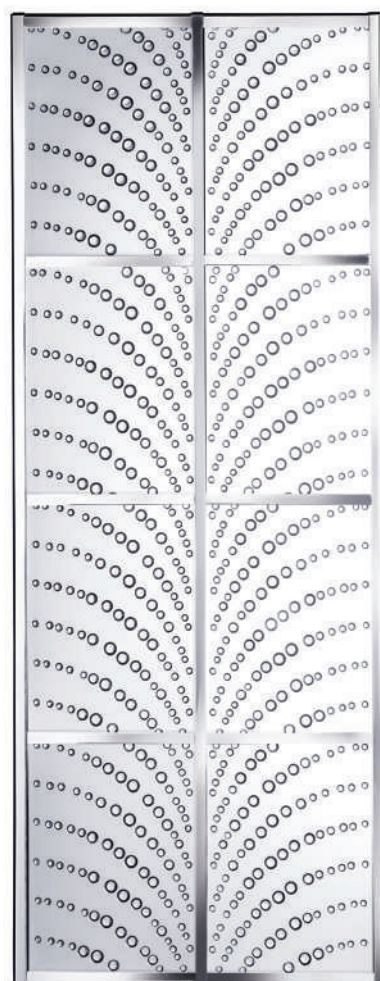

Gauche / Left

Droit / Right

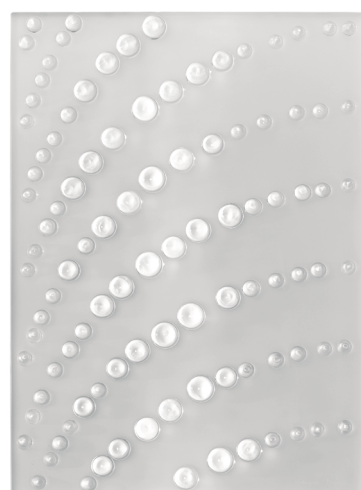
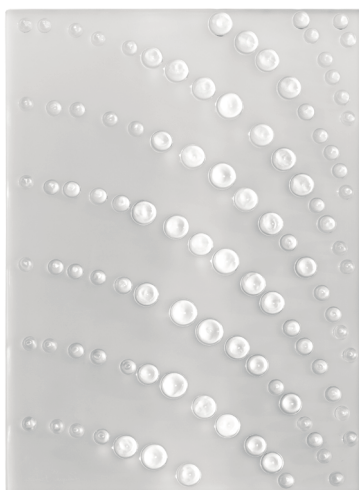

319 mm / 12.56"

12 mm sans décor  
0.47" without decor  
22 mm avec décor  
0.87" with decor

235 mm / 9.25"

3,80 kg / 8.38 pounds

Modèle avec monture disponible uniquement sur commande spéciale.

*Panels with frame are only available on special order.*

tolérance / tolerance : +1,5 mm / - 1,5 mm



22 ± 1,5



FINITION / FINISHING

REFERENCE

EAN CODE

**DROIT**



**NON MIROITÉ**  
**NON MIRRORRED**

CRISTAL INCOLORE - CLEAR CRYSTAL

1023700



**MIROITÉ**  
**MIRRORED**

CRISTAL INCOLORE - CLEAR CRYSTAL

1023710



**GAUCHE**



**NON MIROITÉ**  
**NON MIRRORRED**

CRISTAL INCOLORE - CLEAR CRYSTAL

1023600



**MIROITÉ**  
**MIRRORED**

CRISTAL INCOLORE - CLEAR CRYSTAL

1023610



1935 - René Lalique

Détails techniques et instructions de montage : cf fiche architecture. / *Technical datas & mounting instructions: see architecture files.*

## FEMME BRAS LEVÉS

PANNEAU SANS FEUILLURE  
 PANEL WITHOUT RABBET



tolérance / tolerance : +1,5 mm / - 1,5 mm

FINITION / FINISHING

REFERENCE

EAN CODE



**NON MIROITÉ**  
**NON MIRRORRED**

CRISTAL INCOLORE - *CLEAR CRYSTAL*

1023200



**MIROITÉ**  
**MIRRORED**

CRISTAL INCOLORE - *CLEAR CRYSTAL*

1023210



1928 - René Lalique

Détails techniques et instructions de montage : cf fiche architecture. / *Technical datas & mounting instructions: see architecture files.*

FEMME BRAS LEVÉS XXL

CIRE PERDUE / *LOST WAX*

PANNEAU AVEC FEUILLURE  
PANEL WITH RABBET



25 kg / 55.12 pounds

FINITION / *FINISHING*

REFERENCE

EAN CODE



**NON MIROITÉ**  
**NON MIRRORED**

CRISTAL INCOLORE - *CLEAR CRYSTAL*

10596600



**MIROITÉ**  
**MIRRORED**

CRISTAL INCOLORE - *CLEAR CRYSTAL*

10596700



1928 - René Lalique

Détails techniques et instructions de montage : cf fiche architecture. / *Technical datas & mounting instructions: see architecture files.*

## FEMME TÊTE LEVÉE

PANNEAU AVEC FEUILLURE  
 PANEL WITH RABBET



tolérance / *tolerance* : +1,5 mm / - 1,5 mm

FINITION / *FINISHING*

REFERENCE

EAN CODE



**NON MIROITÉ**  
**NON MIRRORED**

CRISTAL INCOLORE - *CLEAR CRYSTAL*

1023100



**MIROITÉ**  
**MIRRORED**

CRISTAL INCOLORE - *CLEAR CRYSTAL*

1023110



1928 - René Lalique

Détails techniques et instructions de montage : cf fiche architecture. / *Technical datas & mounting instructions: see architecture files.*

FIGURINE ET RAISINS

PANNEAU AVEC FEUILLURE  
PANEL WITH RABBET



2,80 kg / 6.17 pounds

tolérance / tolerance : +1,5 mm / - 1,5 mm

FINITION / FINISHING

REFERENCE

EAN CODE



**NON MIROITÉ**  
**NON MIRRORED**

CRISTAL INCOLORE - *CLEAR CRYSTAL*

10067800



**MIROITÉ**  
**MIRRORED**

CRISTAL INCOLORE - *CLEAR CRYSTAL*

10067900



1928 - René Lalique

Détails techniques et instructions de montage : cf fiche architecture. / *Technical datas & mounting instructions: see architecture files.*







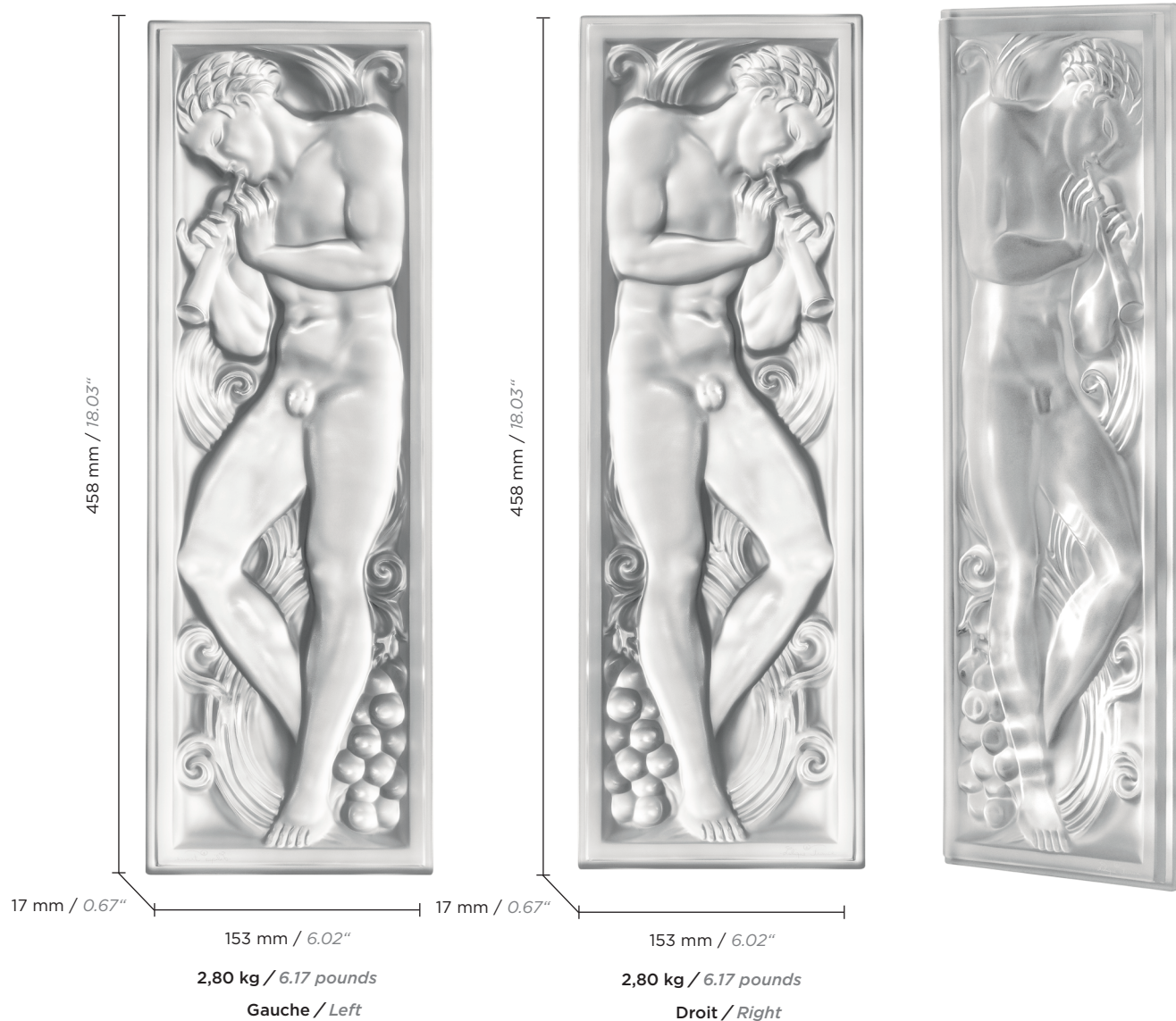

# PANNEAUX DÉCORATIFS - *DECORATIVE PANELS*

## JOUEUR DE PIPEAU

PANNEAUX AVEC FEUILLURE  
PANELS DIMENSIONS WITH RABBET



tolérance / *tolerance* : +1,5 mm / - 1,5 mm

FINITION / <i>FINISHING</i>		REFERENCE	EAN CODE
<b>GAUCHE</b> 	<b>NON MIROITÉ</b> <b>NON MIRRORRED</b>	CRISTAL INCOLORE - <i>CLEAR CRYSTAL</i>	1023300 
	<b>MIROITÉ</b> <b>MIRRORED</b>	CRISTAL INCOLORE - <i>CLEAR CRYSTAL</i>	1023310 
<b>DROIT</b> 	<b>NON MIROITÉ</b> <b>NON MIRRORRED</b>	CRISTAL INCOLORE - <i>CLEAR CRYSTAL</i>	10040100 
	<b>MIROITÉ</b> <b>MIRRORED</b>	CRISTAL INCOLORE - <i>CLEAR CRYSTAL</i>	10040200 

1928 - René Lalique

Détails techniques et instructions de montage : cf fiche architecture. / *Technical datas & mounting instructions: see architecture files.*

# PANNEAUX DÉCORATIFS - *DECORATIVE PANELS*

**LAURIERS**  
PANNEAU SANS FEUILLURE  
PANEL WITHOUT RABBET

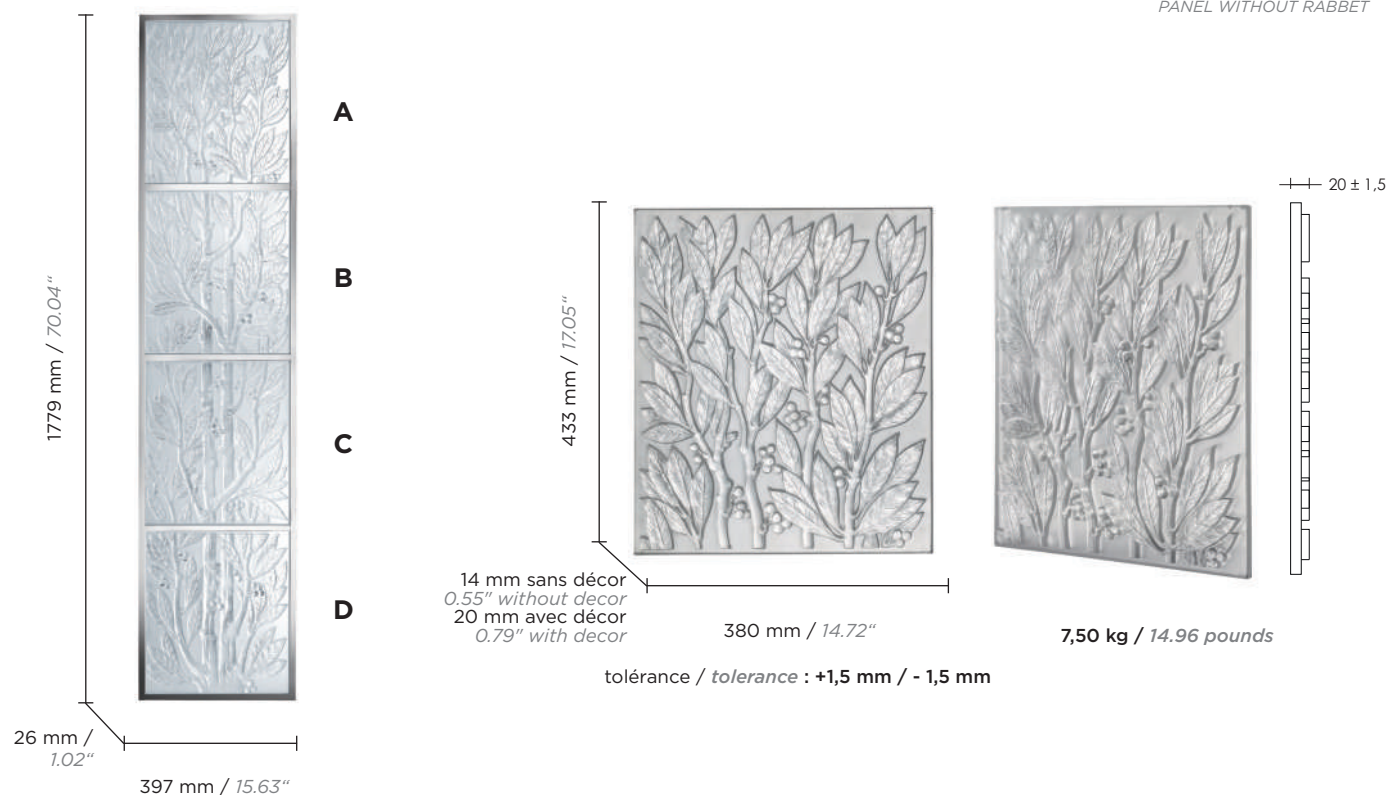

**38,5 kg / 84.90 pounds**  
exemple de mise en monture en T de la manufacture cf.p 111 / 1.2

FINITION / FINISHING		REFERENCE	EAN CODE
	<b>NON MIROITÉ</b> <b>NON MIRRORED</b>	CRISTAL INCOLORE - <i>CLEAR CRYSTAL</i>	1023800
	<b>MIROITÉ</b> <b>MIRRORED</b>	CRISTAL INCOLORE - <i>CLEAR CRYSTAL</i>	1023810
	<b>NON MIROITÉ</b> <b>NON MIRRORED</b>	CRISTAL INCOLORE - <i>CLEAR CRYSTAL</i>	1023900
	<b>MIROITÉ</b> <b>MIRRORED</b>	CRISTAL INCOLORE - <i>CLEAR CRYSTAL</i>	1023910
	<b>NON MIROITÉ</b> <b>NON MIRRORED</b>	CRISTAL INCOLORE - <i>CLEAR CRYSTAL</i>	1024000
	<b>MIROITÉ</b> <b>MIRRORED</b>	CRISTAL INCOLORE - <i>CLEAR CRYSTAL</i>	1024010
	<b>NON MIROITÉ</b> <b>NON MIRRORED</b>	CRISTAL INCOLORE - <i>CLEAR CRYSTAL</i>	1024100
	<b>MIROITÉ</b> <b>MIRRORED</b>	CRISTAL INCOLORE - <i>CLEAR CRYSTAL</i>	1024110
<b>ENSEMBLE DE 4 PANNEAUX</b> <b>LAURIERS MIROITÉS*</b> <b>4 LAURIERS MIRRORED PANELS*</b>		CRISTAL INCOLORE - <i>CLEAR CRYSTAL</i>	1024200

1923 - René Lalique

Détails techniques et instructions de montage : cf fiche architecture. / *Technical datas & mounting instructions: see architecture files.*

\*Livré avec monture, prêt à encadrer. Fixation sur face arrière du support. / *\*Delivered with frame to be fitted. To be fixed on back side of supporting material.*

# PANNEAUX DÉCORATIFS - *DECORATIVE PANELS*

## LES CAUSEUSES

PANNEAU SANS FEUILLURE  
 PANEL WITHOUT RABBET

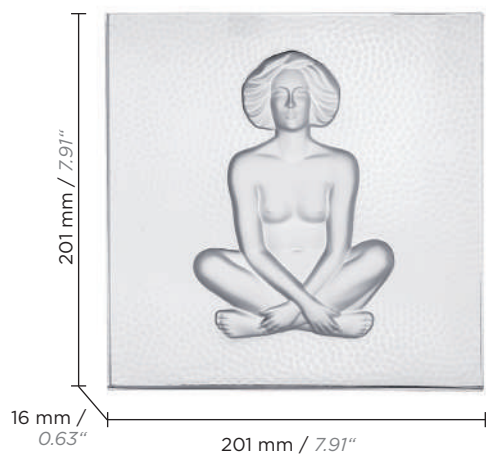

1,70 kg / 3.75 pounds

PM Face / SS front



PM Dos / SS back



3,95 kg / 8.71 pounds

GM / LS

tolérance / tolerance : +1,5 mm / - 1,5 mm

FINITION / FINISHING

REFERENCE

EAN CODE



**PM FACE NON MIROITÉ**  
**SS FRONT, NON MİRRORED**

CRISTAL INCOLORE  
 CLEAR CRYSTAL

1021401



**PM DOS NON MIROITÉ**  
**SS BACK, NON MİRRORED**

CRISTAL INCOLORE  
 CLEAR CRYSTAL

1021402



**GM NON MIROITÉ**  
**LS, NON MİRRORED**

CRISTAL INCOLORE  
 CLEAR CRYSTAL

1021501



2004 - LALIQUÉ

Détails techniques et instructions de montage : cf fiche architecture. / Technical datas & mounting instructions: see architecture files.

# PANNEAUX DÉCORATIFS - *DECORATIVE PANELS*

## MASQUE DE FEMME

PANNEAU SANS FEUILLURE  
 PANEL WITHOUT RABBET

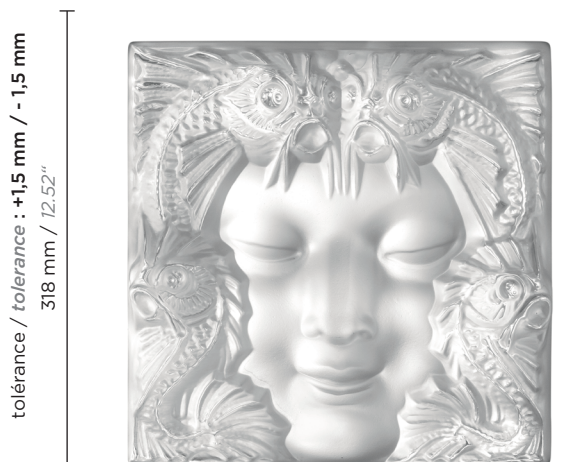

tolérance / tolerance : +1,5 mm / - 1,5 mm  
 318 mm / 12.52"

318 mm / 12.52"

tolérance / tolerance : + 1,5 mm / - 1,5 mm



GM incolore / LS, clear

13,50 kg / 29.76 pounds



102 mm / 4.02"

18 mm / 0.71"

114 mm / 4.49"

0,39 kg / 0.86 pounds

tolérance / tolerance : + 1 mm / - 1 mm

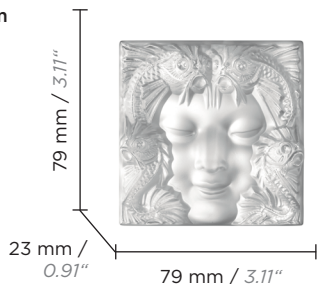

79 mm / 3.11"

23 mm / 0.91"

79 mm / 3.11"

0,28 kg / 0.62 pounds

PM incolore / SS, clear



Révélation Masque de Femme

tolérance / tolerance : + 1 mm / - 1 mm

FINITION / FINISHING

REFERENCE

EAN CODE

PM - SS



**NON MIROITÉ**  
 NON MIRRORED

CRISTAL INCOLORE  
 CLEAR CRYSTAL

10039700



**MIROITÉ**  
 MIRRORED

CRISTAL INCOLORE  
 CLEAR CRYSTAL

10039800



GM - LS



**SIMPLE**  
 SIMPLE

CRISTAL INCOLORE  
 CLEAR CRYSTAL

1164502



**GM SUR CHEVALET**  
 LS WITH STAND

CRISTAL INCOLORE  
 CLEAR CRYSTAL

1164500



**RÉVÉLATION MASQUE DE FEMME**  
 REVELATION MASQUE DE FEMME



**NON MIROITÉ**  
 NON MIRRORED

CRISTAL INCOLORE  
 CLEAR CRYSTAL

10089000



1935 Révélation Masque de Femme

Détails techniques et instructions de montage : cf fiche architecture. / Technical datas & mounting instructions: see architecture files.

# PANNEAUX DÉCORATIFS - *DECORATIVE PANELS*

## MERLES ET RAISINS

PANNEAUX AVEC FEUILLURE  
PANELS DIMENSIONS WITH RABBET



FINITION / FINISHING

REFERENCE

EAN CODE

### TÊTE LEVÉE - HEAD UP



**NON MIROITÉ**  
**NON MIRRORRED**

CRISTAL INCOLORE  
CLEAR CRYSTAL

10372500



**MIROITÉ**  
**MIRRORED**

CRISTAL INCOLORE  
CLEAR CRYSTAL

10364200



### TÊTE BAISSÉ - HEAD DOWN



**NON MIROITÉ**  
**NON MIRRORRED**

CRISTAL INCOLORE  
CLEAR CRYSTAL

10372600



**MIROITÉ**  
**MIRRORED**

CRISTAL INCOLORE  
CLEAR CRYSTAL

10367200



1928 - René Lalique

Détails techniques et instructions de montage : cf fiche architecture. / Technical datas & mounting instructions: see architecture files.

## MERLES ET RAISINS

PANNEAU AVEC FEUILLURE  
 PANEL WITH RABBET



Gauche / *Left*



Droit / *Right*

tolérance / *tolerance* : + 1 mm / - 1 mm

FINITION / *FINISHING*

REFERENCE

EAN CODE

**GAUCHE - LEFT**



**NON MIROITÉ**  
**NON MIRRORED**

CRISTAL INCOLORE  
 CLEAR CRYSTAL

1024800



**MIROITÉ**  
**MIRRORED**

CRISTAL INCOLORE  
 CLEAR CRYSTAL

1024810



**DROIT - RIGHT**



**NON MIROITÉ**  
**NON MIRRORED**

CRISTAL INCOLORE  
 CLEAR CRYSTAL

1024900



**MIROITÉ**  
**MIRRORED**

CRISTAL INCOLORE  
 CLEAR CRYSTAL

1024910



1928 - René Lalique

Détails techniques et instructions de montage : cf fiche architecture. / *Technical datas & mounting instructions: see architecture files.*

# PANNEAUX DÉCORATIFS - *DECORATIVE PANELS*

## MERLES ET RAISINS

### COMPOSITION / *ARRANGEMENT*

PANNEAU AVEC FEUILLURE  
 PANEL WITH RABBET

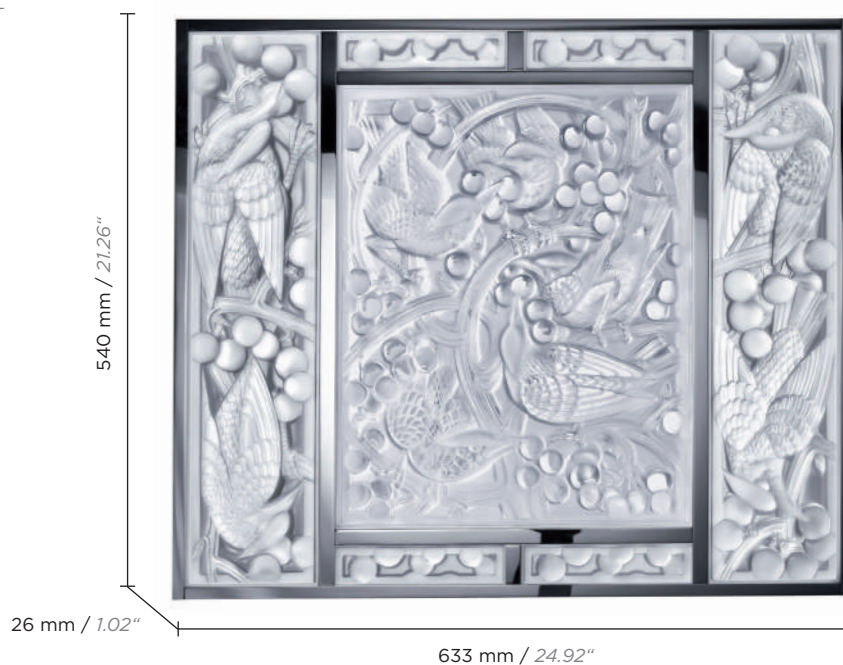

25 kg / 55.12 pounds

Composition Merles et Raisins Tête Levée miroité / *Merles et Raisins Head Up arrangement, mirrored*



Composition Merles et Raisins Tête Baissée miroité / *Merles et Raisins Head Down arrangement, mirrored*

FINITION / *FINISHING*

REFERENCE

EAN CODE



**TÊTE LEVÉE MIROITÉ - HEAD UP, MIRRORED**  
 CRISTAL INCOLORE - *CLEAR CRYSTAL*  
 CHROMÉ - *CHROME*

10372900



**TÊTE BAISSÉE MIROITÉ - HEAD DOWN, MIRRORED**  
 CRISTAL INCOLORE - *CLEAR CRYSTAL*  
 CHROMÉ - *CHROME*

10372800



2014 - LALIQUE

Détails techniques et instructions de montage : cf fiche architecture. / *Technical datas & mounting instructions: see architecture files.*

MERLES ET RAISINS

COMPOSITION XXL / *LS ARRANGEMENT*

PANNEAU AVEC FEUILLURE  
*PANEL WITH RABBET*



FINITION / *FINISHING*

REFERENCE

EAN CODE



CRISTAL INCOLORE - *CLEAR CRYSTAL*  
CHROMÉ - *CHROME*

10695900



2019 - LALIQUE



# PANNEAUX DÉCORATIFS - *DECORATIVE PANELS*

## PETITES BULLES

PANNEAU AVEC FEUILLURE  
PANEL WITH RABBET



165 mm / 6.50"

0,3 kg / 0.66 pounds

tolérance / tolerance : + 1 mm / - 1 mm



FINITION / FINISHING

REFERENCE

EAN CODE

**NON MIROITÉ**  
**NON MIRRORED**

CRISTAL INCOLORE - CLEAR CRYSTAL

10373200



**MIROITÉ**  
**MIRRORED**

CRISTAL INCOLORE - CLEAR CRYSTAL

10373100



2014 - LALIQUE

Détails techniques et instructions de montage : cf fiche architecture. / Technical datas & mounting instructions: see architecture files.



36 mm / 1.42"  
8 mm / 0.31"  
26 mm / 1.02"

0,02 kg / 0.04 pounds  
PM / SS

PANNEAU SANS FEUILLURE  
PANEL WITHOUT RABBET



36 mm / 1.42"  
8 mm / 0.31"  
52 mm / 2.05"

0,04 kg / 0.09 pounds  
SIMPLE

PANNEAU SANS FEUILLURE  
PANEL WITHOUT RABBET



103 mm / 4.06"  
0,08 kg / 0.18 pounds

DOUBLE



152 mm / 5.98"  
0,12 kg / 0.26 pounds

TRIPLE

PANNEAU AVEC FEUILLURE  
PANEL WITH RABBET

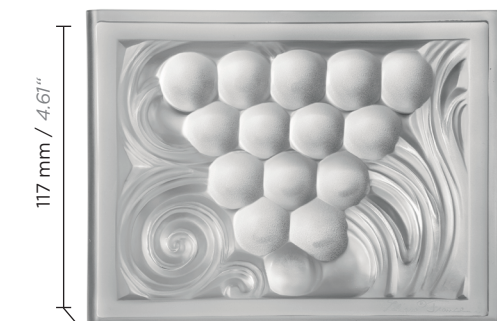

117 mm / 4.61"  
14 mm / 0.55"  
153 mm / 6.02"

Gauche / Left



Centre / Center























Droit / Right

0,60 kg / 1.32 pounds  
tolérance / tolerance : + 1 mm / - 1 mm

# PANNEAUX DÉCORATIFS - *DECORATIVE PANELS*

## RAISINS

FINITION / FINISHING			REFERENCE	EAN CODE	
<b>PM - SS</b>		<b>NON MIROITÉ</b> <i>NON MIRRORED</i>	CRISTAL INCOLORE <i>CLEAR CRYSTAL</i>	1024600	
		<b>MIROITÉ</b> <i>MIRRORED</i>	CRISTAL INCOLORE <i>CLEAR CRYSTAL</i>	1024610	
<b>SIMPLE - SIMPLE</b>		<b>NON MIROITÉ</b> <i>NON MIRRORED</i>	CRISTAL INCOLORE <i>CLEAR CRYSTAL</i>	1025200	
		<b>MIROITÉ</b> <i>MIRRORED</i>	CRISTAL INCOLORE <i>CLEAR CRYSTAL</i>	1025210	
<b>DOUBLE - DOUBLE</b>		<b>NON MIROITÉ</b> <i>NON MIRRORED</i>	CRISTAL INCOLORE <i>CLEAR CRYSTAL</i>	1025100	
		<b>MIROITÉ</b> <i>MIRRORED</i>	CRISTAL INCOLORE <i>CLEAR CRYSTAL</i>	1025110	
<b>TRIPLE - TRIPLE</b>		<b>NON MIROITÉ</b> <i>NON MIRRORED</i>	CRISTAL INCOLORE <i>CLEAR CRYSTAL</i>	1024700	
		<b>MIROITÉ</b> <i>MIRRORED</i>	CRISTAL INCOLORE <i>CLEAR CRYSTAL</i>	1024710	
<b>DROIT - RIGHT</b>		<b>NON MIROITÉ</b> <i>NON MIRRORED</i>	CRISTAL INCOLORE <i>CLEAR CRYSTAL</i>	1022800	
		<b>MIROITÉ</b> <i>MIRRORED</i>	CRISTAL INCOLORE <i>CLEAR CRYSTAL</i>	1022810	
<b>GAUCHE - LEFT</b>		<b>NON MIROITÉ</b> <i>NON MIRRORED</i>	CRISTAL INCOLORE <i>CLEAR CRYSTAL</i>	1022900	
		<b>MIROITÉ</b> <i>MIRRORED</i>	CRISTAL INCOLORE <i>CLEAR CRYSTAL</i>	1022910	
<b>CENTRE - CENTER</b>		<b>NON MIROITÉ</b> <i>NON MIRRORED</i>	CRISTAL INCOLORE <i>CLEAR CRYSTAL</i>	1023000	
		<b>MIROITÉ</b> <i>MIRRORED</i>	CRISTAL INCOLORE <i>CLEAR CRYSTAL</i>	1023010	

1928 - René Lalique

Détails techniques et instructions de montage : cf fiche architecture. / *Technical datas & mounting instructions: see architecture files.*

# PANNEAUX DÉCORATIFS - *DECORATIVE PANELS*

## ROSES

PANNEAU AVEC FEUILLURE  
PANEL WITH RABBET

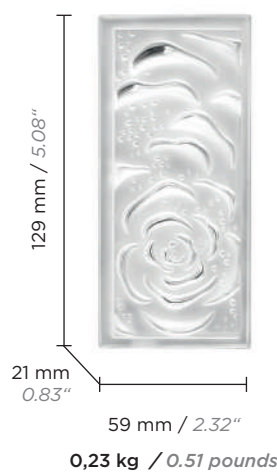

PM / MS



MM / SS



GM / LS

tolérance / tolerance : + 1 mm / - 1 mm

FINITION / FINISHING		REFERENCE	EAN CODE
	<b>NON MIROITÉ</b> <i>NON MIRRORED</i>	CRISTAL INCOLORE <i>CLEAR CRYSTAL</i>	10122600 
	<b>MIROITÉ</b> <i>MIRRORED</i>	CRISTAL INCOLORE <i>CLEAR CRYSTAL</i>	10122700 
	<b>NON MIROITÉ</b> <i>NON MIRRORED</i>	CRISTAL INCOLORE <i>CLEAR CRYSTAL</i>	10210200 
	<b>MIROITÉ</b> <i>MIRRORED</i>	CRISTAL INCOLORE <i>CLEAR CRYSTAL</i>	10210300 
	<b>NON MIROITÉ</b> <i>NON MIRRORED</i>	CRISTAL INCOLORE <i>CLEAR CRYSTAL</i>	10122200 
	<b>MIROITÉ</b> <i>MIRRORED</i>	CRISTAL INCOLORE <i>CLEAR CRYSTAL</i>	10122300 

2011 - LALIQUE

Détails techniques et instructions de montage : cf fiche architecture. / *Technical datas & mounting instructions: see architecture files.*

# PANNEAUX DÉCORATIFS - *DECORATIVE PANELS*

## SOUDAN

PANNEAU AVEC FEUILLURE  
 PANEL WITH RABBET

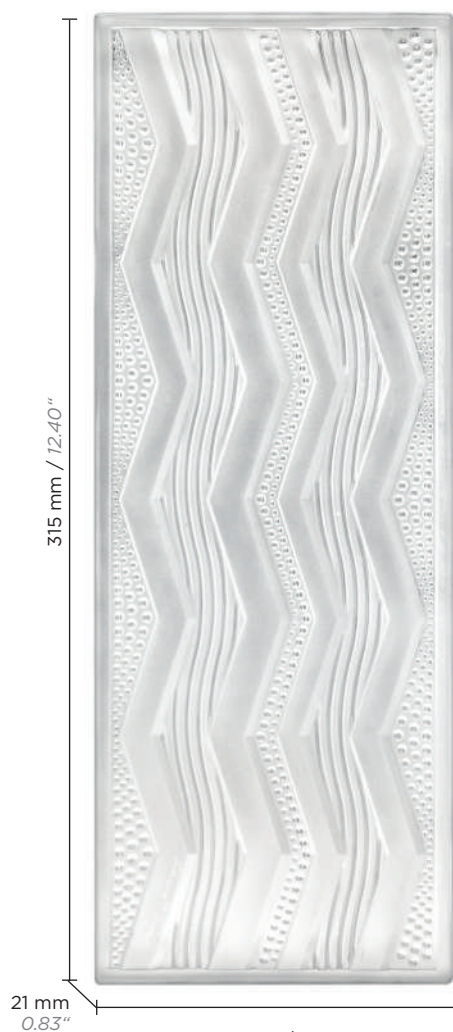

115 mm / 4.53"  
 1,68 kg / 3.70 pounds

GM / LS

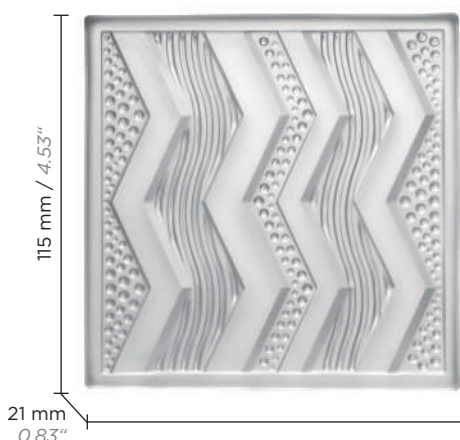

115 mm / 4.53"  
 0,57 kg / 1.26 pounds

MM / SS



59 mm / 2.32"

0,24 kg / 0.53 pounds

PM / MS

tolérance / tolerance : + 1 mm / - 1 mm

FINITION / FINISHING

REFERENCE

EAN CODE

PM - SS



**NON MIROITÉ**  
 NON MIRRORED

CRISTAL INCOLORE  
 CLEAR CRYSTAL

10122000



**MIROITÉ**  
 MIRRORED

CRISTAL INCOLORE  
 CLEAR CRYSTAL

10122100



MM - MS



**NON MIROITÉ**  
 NON MIRRORED

CRISTAL INCOLORE  
 CLEAR CRYSTAL

10121800



**MIROITÉ**  
 MIRRORED

CRISTAL INCOLORE  
 CLEAR CRYSTAL

10121900



GM - LS



**NON MIROITÉ**  
 NON MIRRORED

CRISTAL INCOLORE  
 CLEAR CRYSTAL

10121600



**MIROITÉ**  
 MIRRORED

CRISTAL INCOLORE  
 CLEAR CRYSTAL

10121700



2011 - LALIQUE

Détails techniques et instructions de montage : cf fiche architecture. / *Technical datas & mounting instructions: see architecture files.*

# PANNEAUX DÉCORATIFS - *DECORATIVE PANELS*

## VIBRATION

PANNEAU AVEC FEUILLURE  
PANEL WITH RABBET

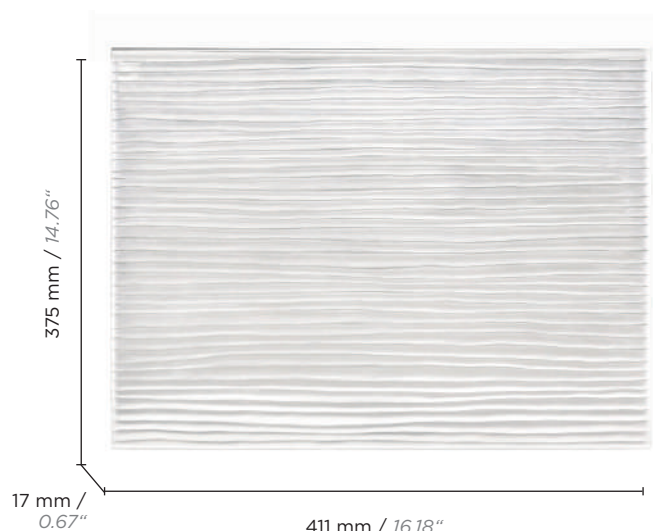

411 mm / 16.18"

7 kg / 15.43 pounds

Incolore / Clear



Lustré or / Gold luster

Photo non contractuelle / Not contractual picture

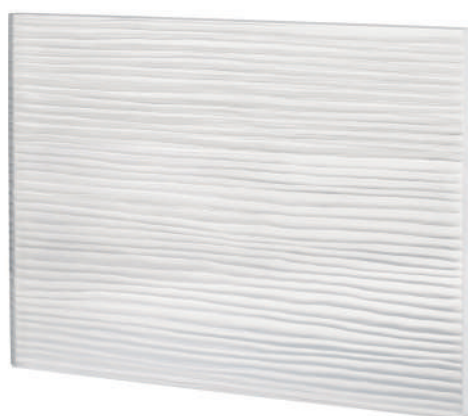

### FINITION / FINISHING

### REFERENCE

### EAN CODE



**NON MIROITÉ**  
**NON MIRRORED**

CRISTAL INCOLORE  
CLEAR CRYSTAL

10633300



**MIROITÉ**  
**MIRRORED**

CRISTAL INCOLORE  
CLEAR CRYSTAL

10671000



**NON MIROITÉ**  
**NON MIRRORED**

CRISTAL LUSTRÉ OR  
GOLD LUSTER CRYSTAL

10633400



**MIROITÉ**  
**MIRRORED**

CRISTAL LUSTRÉ OR  
GOLD LUSTER CRYSTAL

10633500



2018 - LALIQUE

Détails techniques et instructions de montage : cf fiche architecture. / *Technical datas & mounting instructions: see architecture files.*

La juxtaposition de plusieurs panneaux ne permet pas un parfait alignement des lignes du motif. *Putting many panels next to one another will not allow a perfect alignment of the motifs.*

# PANNEAUX DÉCORATIFS - *DECORATIVE PANELS*

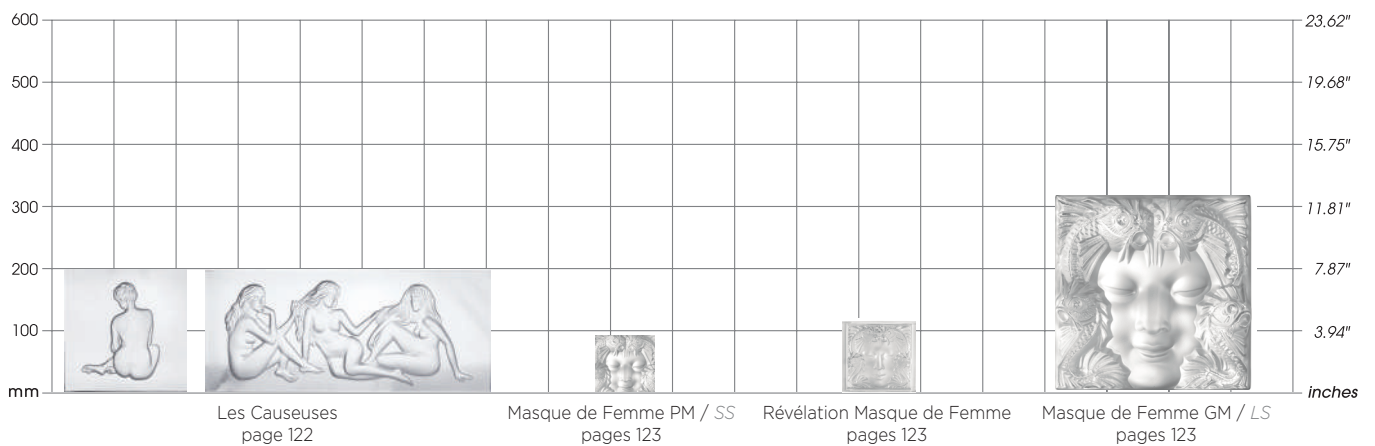
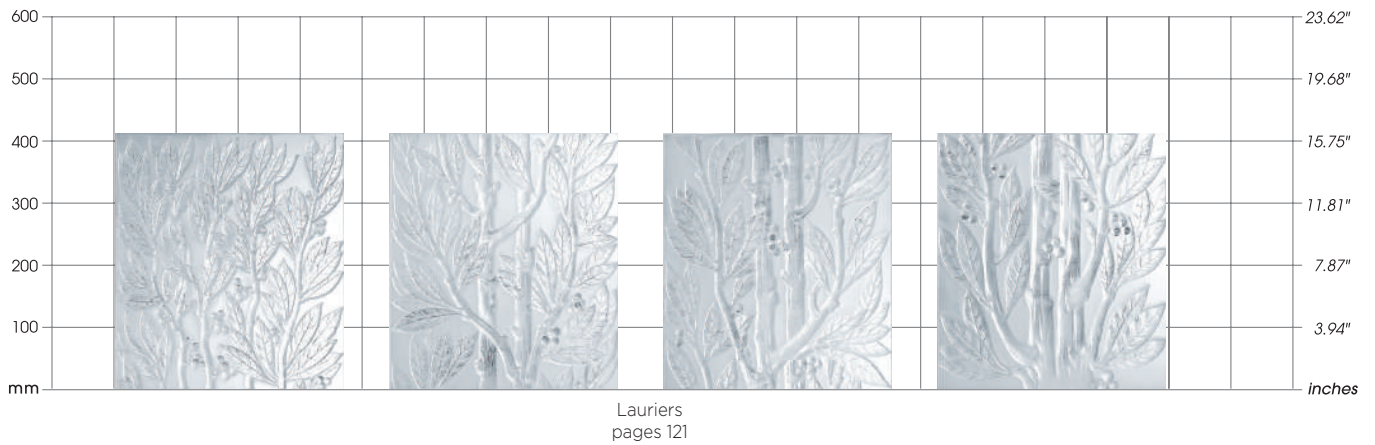
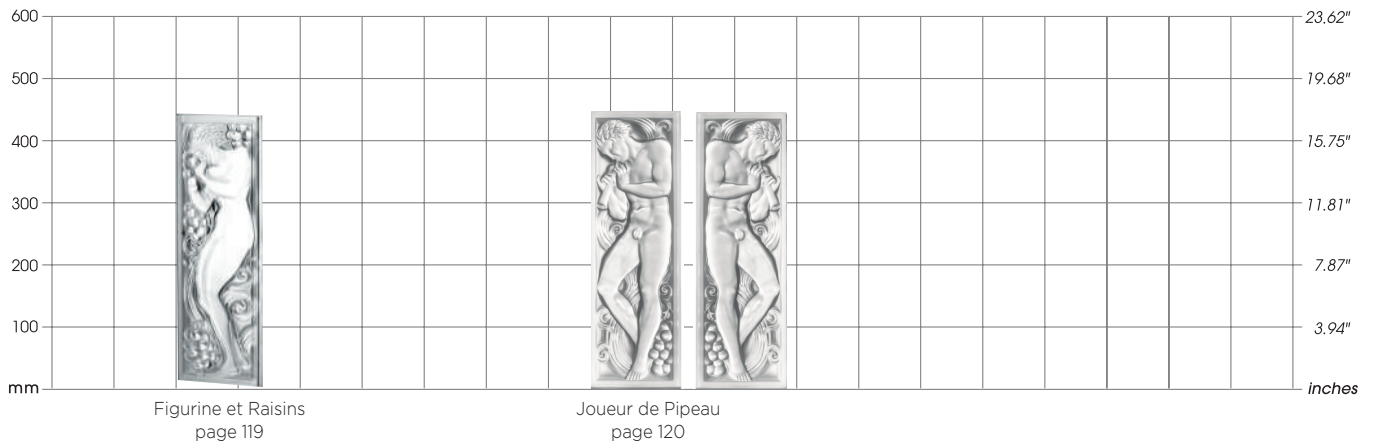
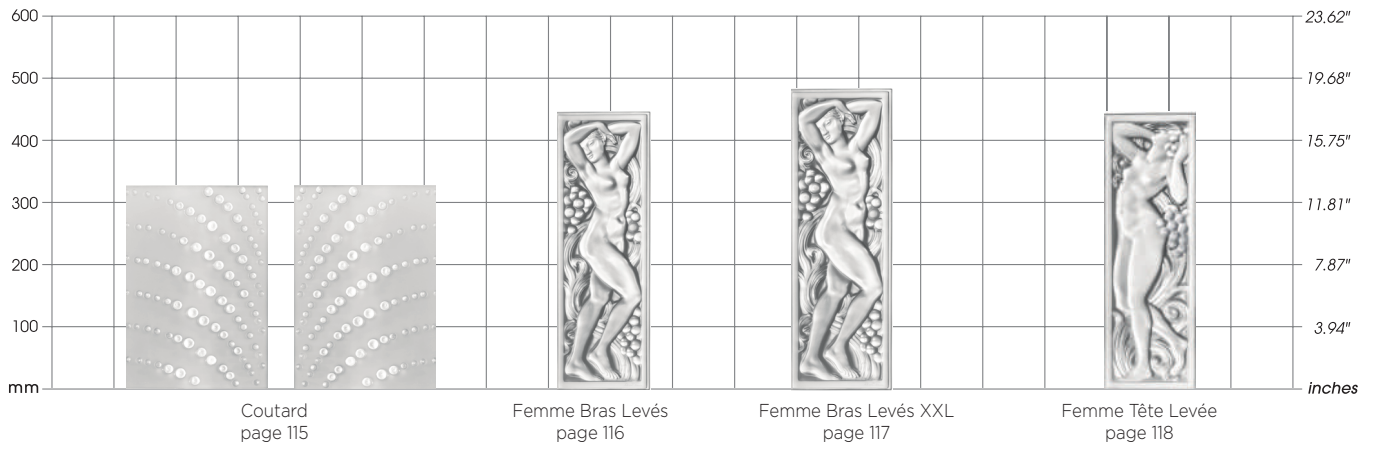

# PANNEAUX DÉCORATIFS - *DECORATIVE PANELS*

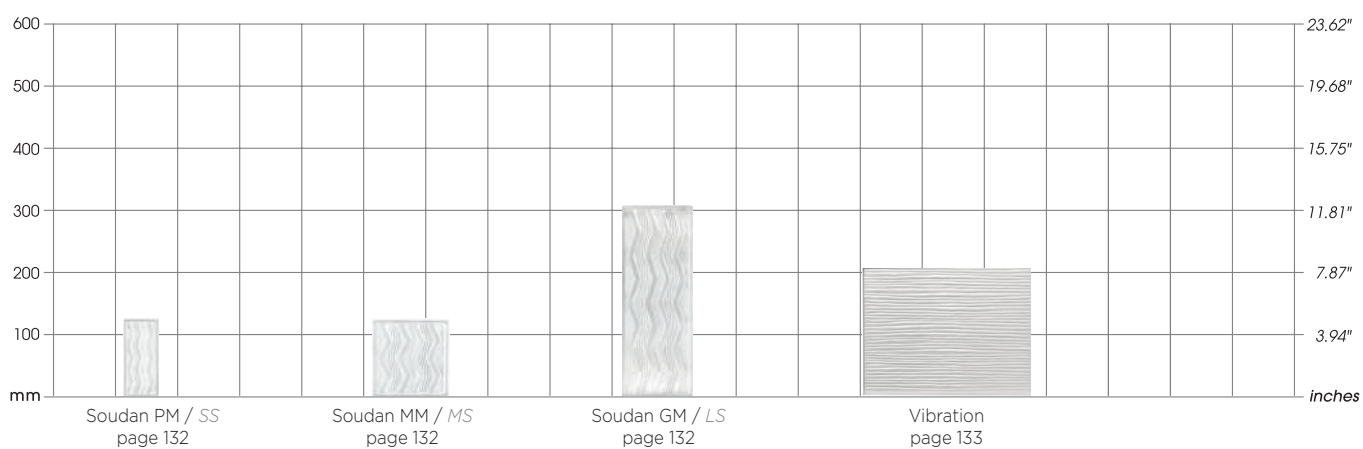
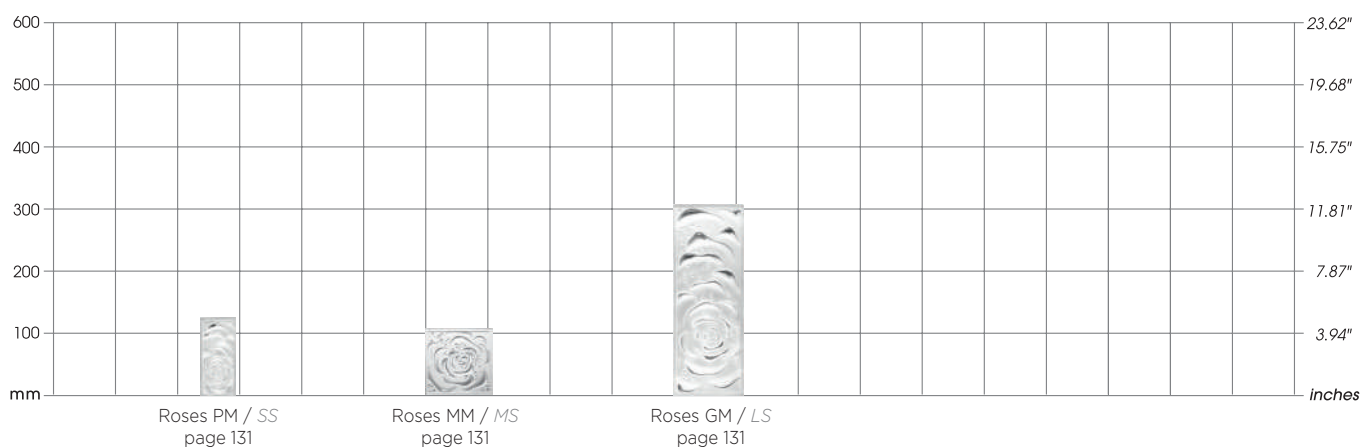
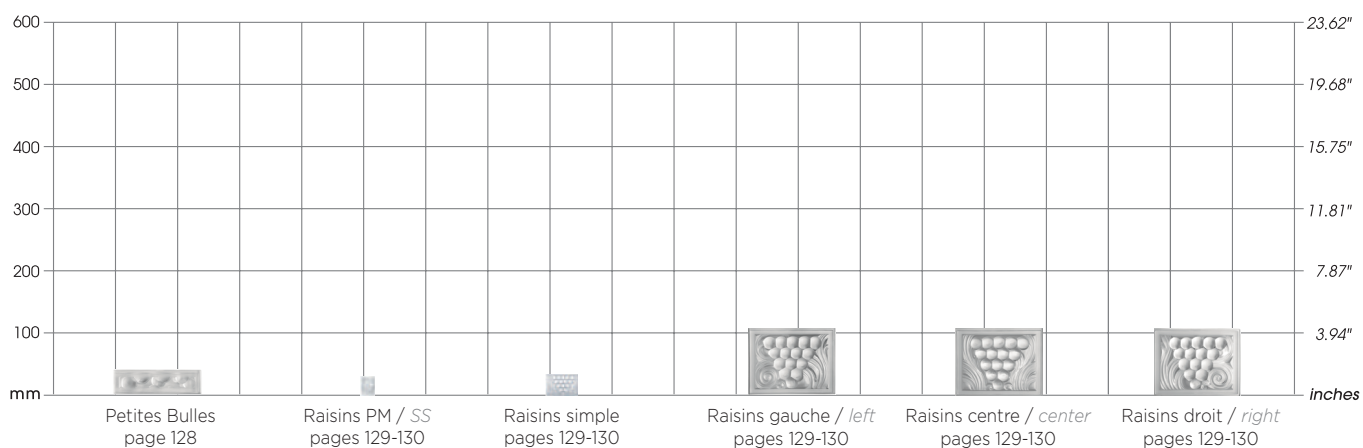
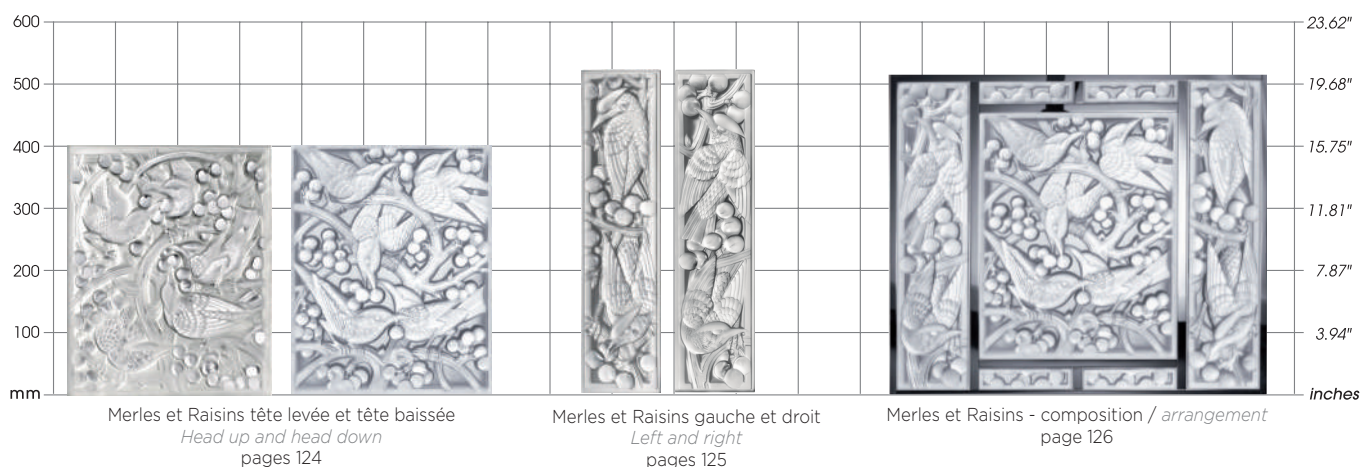



2.

PANNEAUX DÉCORATIFS ENCADRÉS  
*FRAMED DECORATIVE PANELS*

# PANNEAUX DÉCORATIFS ENCADRÉS - *FRAMED DECORATIVE PANELS*

## FEMME BRAS LEVÉS



## FEMME BRAS LEVÉS XXL CIRE PERDUE / *LOST WAX*



FEMME BRAS LEVÉS

REFERENCE

EAN CODE

**MIROITÉ ENCADRÉ**  
**MIRRORED FRAMED**

CRISTAL INCOLORE - *CLEAR CRYSTAL*

10625400



FEMME BRAS LEVÉS XXL CIRE PERDUE / *LOST WAX*

REFERENCE

EAN CODE

**MIROITÉ ENCADRÉ**  
**MIRRORED FRAMED**

CRISTAL INCOLORE - *CLEAR CRYSTAL*

10596800



1928 - René Lalique

# PANNEAUX DÉCORATIFS ENCADRÉS - *FRAMED DECORATIVE PANELS*

## FEMME TÊTE LEVÉE



## FIGURINE ET RAISINS



FEMME TÊTE LEVÉE

REFERENCE

EAN CODE

**MIROITÉ ENCADRÉ**  
**MIRRORED, FRAMED**

CRISTAL INCOLORE - CLEAR CRYSTAL

10625500



FIGURINE ET RAISINS

**MIROITÉ ENCADRÉ**  
**MIRRORED FRAMED**

CRISTAL INCOLORE - CLEAR CRYSTAL

10625600



1928 - René Lalique

JOUEUR DE PIPEAU





Gauche encadré / *Left framed*



6,2 kg / 13.66 pounds

Droit encadré / *Right framed*

JOUEUR DE PIPEAU		REFERENCE	EAN CODE
<b>GAUCHE</b>	<b>MIROITÉ ENCADRÉ</b> <i>MIRRORED FRAMED</i>	CRISTAL INCOLORE - <i>CLEAR CRYSTAL</i>	10625700
			 0 90592 89539 9
<b>DROIT</b>	<b>MIROITÉ ENCADRÉ</b> <i>MIRRORED FRAMED</i>	CRISTAL INCOLORE - <i>CLEAR CRYSTAL</i>	10625800
			 0 90592 89538 2

# PANNEAUX DÉCORATIFS ENCADRÉS - *FRAMED DECORATIVE PANELS*

## MASQUE DE FEMME GM

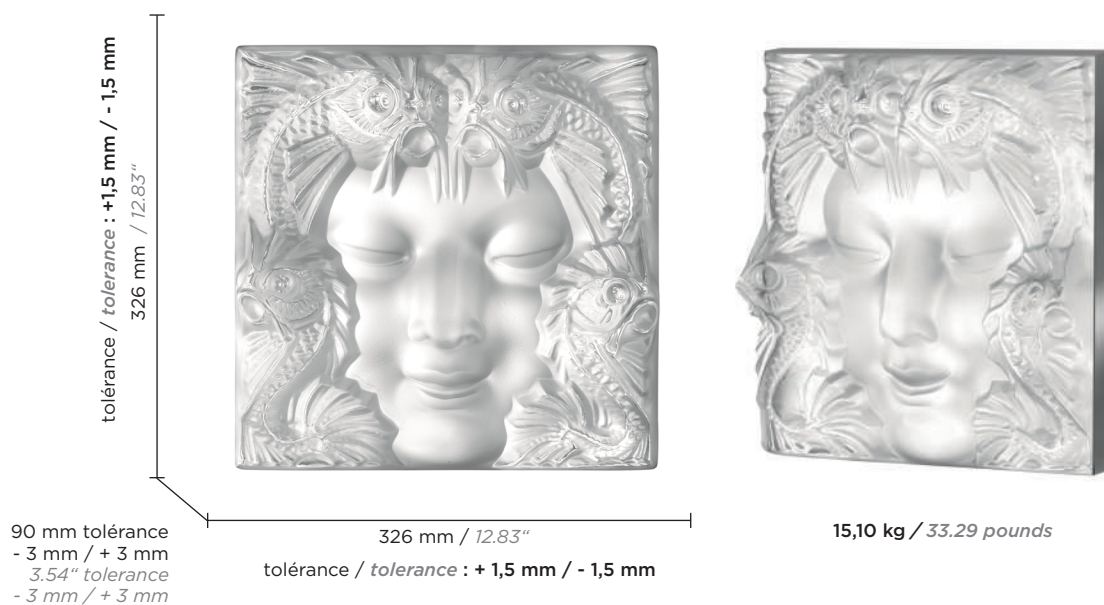

MASQUE DE FEMME

REFERENCE

EAN CODE

CRISTAL INCOLORE  
CLEAR CRYSTAL

1166500



# PANNEAUX DÉCORATIFS ENCADRÉS - *FRAMED DECORATIVE PANELS*

## MERLES ET RAISINS



MERLES ET RAISINS

REFERENCE

EAN CODE

**GAUCHE - LEFT**

**MIROITÉ ENCADRÉ  
MIRRORED FRAMED**

CRISTAL INCOLORE  
CLEAR CRYSTAL

10626000



**DROIT - RIGHT**

**MIROITÉ ENCADRÉ  
MIRRORED FRAMED**

CRISTAL INCOLORE  
CLEAR CRYSTAL

10625900



3.  
PANNEAUX D'ESPACE  
*INTERIOR PANELS*

# PANNEAUX D'ESPACE - *INTERIOR PANELS*

## I. SUGGESTIONS D'INTÉGRATION / *SUGGESTIONS FOR INTEGRATION*

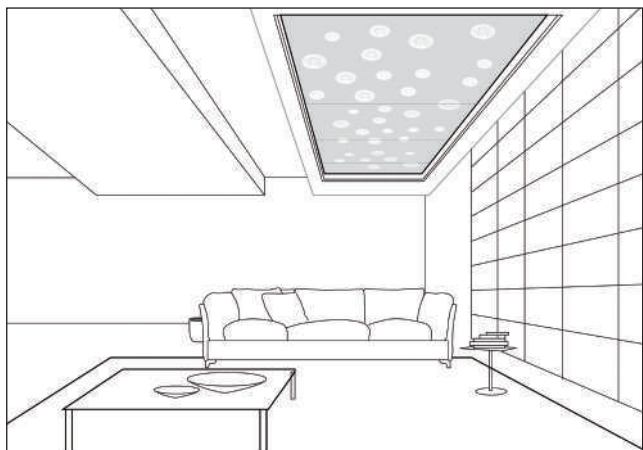

Inserts de plafond, 3 x Dahlia 900 x 900 mm  
*Ceiling inserts, 3 x Dahlia 35.43" x 35.43"*

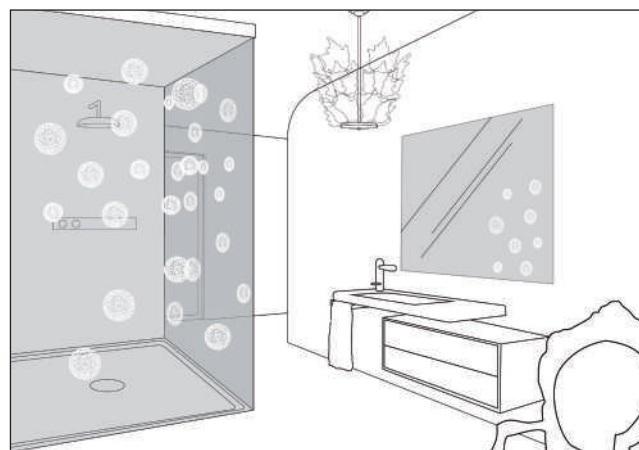

Paroi et miroir Dahlia, sur-mesure  
*Wall and mirror Dahlia, bespoke*

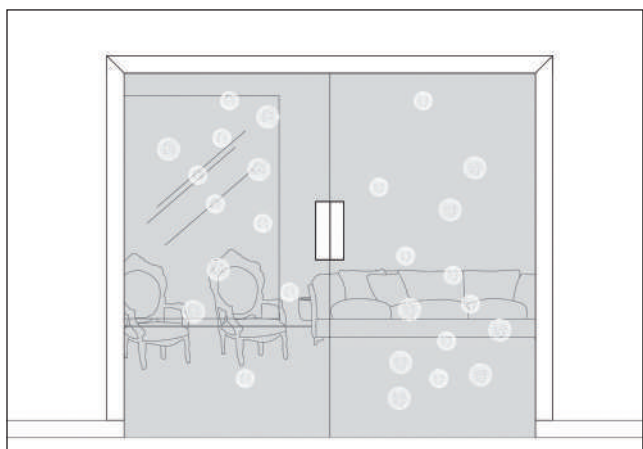

Double porte Dahlia, sur-mesure  
*Dahlia full door, bespoke*

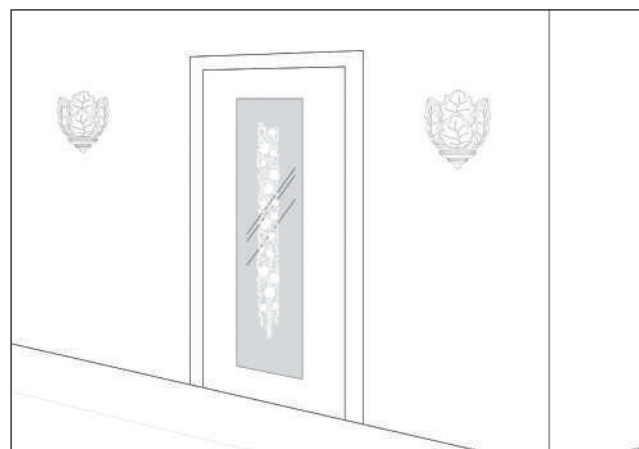

Insert de porte, 1 x Bouquet 1500 x 400 mm  
*Door insert, 1 x Bouquet 59.05" x 15.74"*

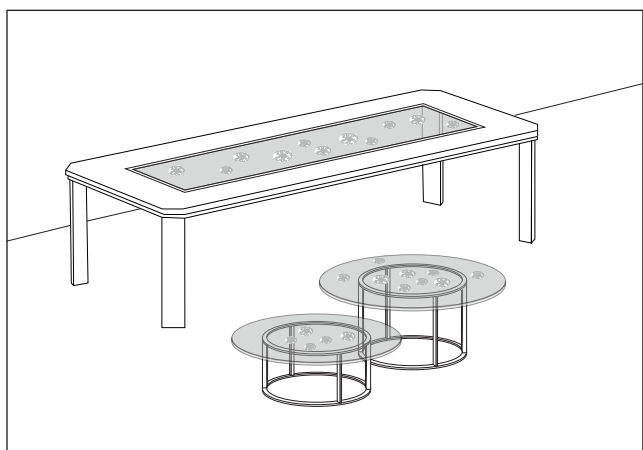

Plateau de table et tables basses Dahlia  
(piétements non fournis par LALIQUE)  
*Dahlia table tops (table base non provided by LALIQUE)*



# PANNEAUX D'ESPACE - INTERIOR PANELS

## II. FORMATS ET DIMENSIONS POSSIBLES / POSSIBLE FORMATS AND DIMENSIONS

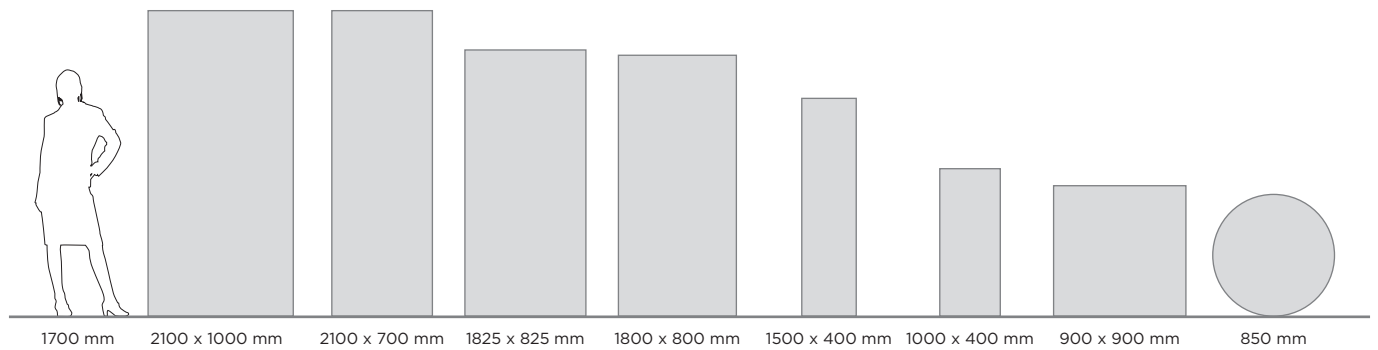

Dimensions et formats disponibles actuellement au catalogue LALIQUE. **À noter que tous les formats et toutes les dimensions sont réalisables sur-mesure à la demande du client après concertation avec Lalique Interior Design Studio.**

Available dimensions and formats in LALIQUE catalogue. **Please note that all formats and dimensions can be customized according to the client request after confirmation with the Lalique Interior Design Studio.**

CLAIR DE VUE (schéma de principe)

“INSIDE MEASUREMENT” (basic sketch)

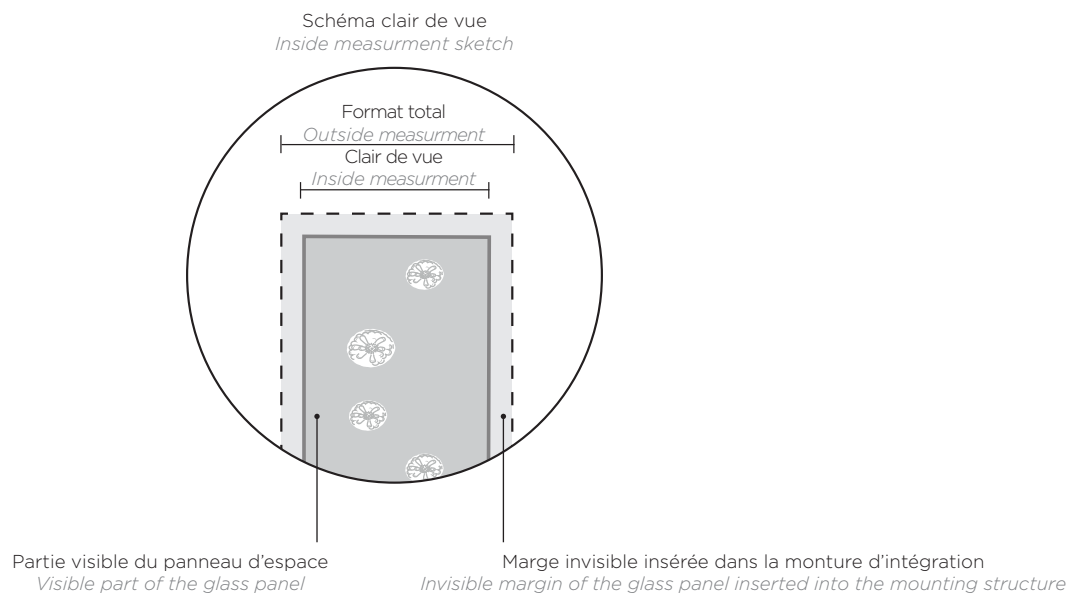

## III. CHOIX DU MOTIF EN CRISTAL / CRYSTAL PATTERN OPTIONS



Bouquet

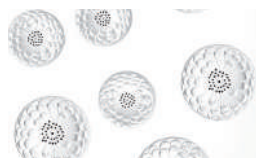

Dahlia



Languedoc



Venise

Le motif cristal peut être choisi parmi notre offre dans la catégorie panneau d'espace. Pour tout autre panneau décoratif, voir avec Lalique Interior Design Studio.

The crystal pattern can be chosen from our interior panels range. For any other decorative panel, please see with Lalique interior Design Studio.

## IV. FINITIONS ESTHÉTIQUES DES PANNEAUX / PANELS AESTHETIC FINISHING

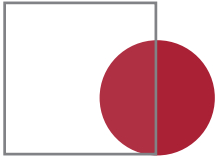

CLAIR / CLEAR  
Panneau transparent  
*Transparent panel*

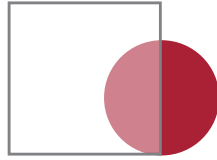

SATINÉ / SATIN  
Panneau semi-transparent  
*Semi-transparent panel*



SATINÉ-MIROITÉ / SATIN-MIRRORED  
Panneau opaque  
*Opaque panel*

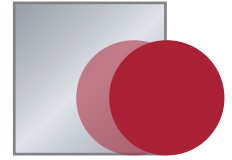

MIROIR / MIRROR  
Panneau réfléchissant  
*Reflective panel*

## V. FINITIONS TECHNIQUES DES PANNEAUX / PANELS TECHNICAL FINISHING

### 1 - SÉCURISATION DU VERRE :

**Le type de sécurisation du verre est défini en fonction du lieu et du panneau sélectionné.**

- VERRE TREMPÉ : Verre de sécurité traité pour être plus résistant qu'un verre normal.
- VERRE FEUILLETÉ : Verre de sécurité constitué d'au moins deux feuilles de verre séparées par un film intercalaire transparent. Les deux couches de verre sont visibles sur la tranche.
- VERRE FEUILLETÉ-TREMPÉ : Verre de sécurité composé d'une plaque de verre trempé et d'une plaque de verre standard, séparées par un film intercalaire transparent.

### 2 - OPTIONS DU VERRE :

- TRAITEMENT ANTI-CALCAIRE : revêtement protecteur contre le calcaire appliqué sur le côté lisse du panneau (sans élément cristal et / ou sablage).
- USINAGE : Possibilités de perçage pour fixer des charnières, poignées (non fournies par LALIQUE), ou de découpe du panneau en formes ovales, rondes...

### 1 - GLASS SECURITY:

**The type of glass security is specified according to the location and the panel selection.**

- TEMPERED GLASS: Security glass treated to be more resistant than a classic glass panel.
- LAYERED GLASS: Security glass made with at least two glass leaves and divided by an interlayer and transparent film. The two coated glass panels can be seen on the edge.
- LAYERED-TEMPERED GLASS: Security glass made with a tempered glass panel and classic glass panel divided by an interlayer and transparent film.

### 2 - GLASS OPTIONS:

- ANTI-SCALE TREATMENT: Anti-scale protective coating applied on the smooth side of the glass panel (without crystal element and / or sandblasting).
- MACHINING: Possibility of drilling, fixing handles (not provided by LALIQUE), or inserting round or oval shapes.

# PANNEAUX D'ESPACE - INTERIOR PANELS

## 3 - TABLEAU DES FINITIONS ESTHÉTIQUES, TECHNIQUES ET OPTIONS POSSIBLES EN FONCTION DU MOTIF CRISTAL :

## 3 - AESTHETICAL, TECHNICAL AND OPTIONS POSSIBLES FINISHING TABLE ACCORDING TO THE CRYSTAL PATTERN:

### BOUQUET



Information données à titre indicatif, à confirmer en fonction du projet.

Data given for information, to be confirmed according to the project.

Finitions esthétiques possibles du panneau	Finitions techniques : sécurisation du verre			Options verre	
	Trempe	Feuilleté	Feuilleté Trempe	Traitement anti-calcaire	Usinages et découpes
Clair	non	oui	oui	oui	oui
Satiné	non	oui	oui	oui	oui
Satiné miroité	non	oui	oui	non	oui

Panel aesthetic	Technical finishes : Glass security			Glass option	
	Tempered	Layered	Layered tempered	Calcium deposit treatment	Machining and cutting
Clear	no	yes	yes	yes	yes
Satin	no	yes	yes	yes	yes
Satin mirrored	no	yes	yes	no	yes

### DAHLIA



### LANGUEDOC



### VENISE



Information données à titre indicatif, à confirmer en fonction du projet.

Data given for information, to be confirmed according to the project.

Finitions esthétiques possibles du panneau	Finitions techniques : sécurisation du verre			Options verre	
	Trempe	Feuilleté	Feuilleté Trempe	Traitement anti-calcaire	Usinages et découpes
Clair	oui	oui	oui	oui	oui
Satiné	oui	oui	oui	oui	oui
Satiné miroité	non	oui	oui	non	oui
Miroir	non	oui	oui	non	oui

Panel aesthetic	Technical finishes : Glass security			Glass option	
	Tempered	Layered	Layered tempered	Calcium deposit treatment	Machining and cutting
Clear	yes	yes	yes	yes	yes
Satin	yes	yes	yes	yes	yes
Satin mirrored	no	yes	yes	no	yes
Mirrored	no	yes	yes	no	yes

## **INFORMATIONS INDISPENSABLES À PRÉCISER POUR TOUTE DEMANDE SUR MESURE :**

**Ces informations sont nécessaires pour la définition et l'étude de prix du panneau sur mesure.**

- I. Environnement d'intégration du panneau et usage (paroi, miroir, insert de porte, etc.)
- II. Format, dimensions, épaisseur du panneau et clair de vue
- III. Choix du motif en cristal
- IV. Finition esthétique des panneaux
- V. Finition(s) technique(s) des panneaux : sécurisation, options du verre dont l'usinage (pour insert de charnières\* et de poignées de porte\*, etc.).
- VI. Information sur la mise en lumière\* prévue du panneau

\*Les systèmes lumineux, les montures, les charnières, les poignées de portes ou autres ne sont pas fournis par LALIQUE.

## ***ESSENTIAL INFORMATION REQUIRED FOR ANY BESPOKE REQUEST:***

***The below information is required to develop the design study and provide a quotation.***

- I. Integration environment and usage of the panel (wall, mirror, door insert, etc.)*
- II. Format, dimensions, thickness of the panel and "inside measurement"*
- III. Crystal pattern choice*
- IV. Panel aesthetic finishing*
- V. Panel technical finishing: glass security, options including machining (drilling\* and handles\* insert, etc.)*
- VI. Information on the required lighting\* of the panel*

*\* Lighting systems, mountings, drillings and handles are not provided by LALIQUE.*

# PANNEAUX D'ESPACE - INTERIOR PANELS

## BOUQUET



1500 mm / 59.05"

400 mm / 15.74"

19 kg / 41.89 pounds



1800 mm / 70.86"

800 mm / 31.49"

45 kg / 99.21 pounds



2100 mm / 82.67"

1000 mm / 39.37"

67 kg / 147.71 pounds

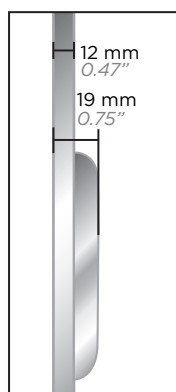

Épaisseur 12 mm - jusqu'à 19 mm  
au niveau des fleurs de cristal  
Thickness 0.47" - up to 0.75" for  
the crystal flowers

### FINITION / FINISHING

**H1500 X L400MM**  
*H59.05" X L15.74"*

**VERRE SATINÉ**  
*SATIN FINISH GLASS*



CRISTAL INCOLORE  
*CLEAR CRYSTAL*

### REFERENCE

10302000

### EAN CODE



**H1800 X L800MM**  
*H70.86" X L31.49"*

**VERRE SATINÉ**  
*SATIN FINISH GLASS*



CRISTAL INCOLORE  
*CLEAR CRYSTAL*

10302100



**H2100 X L1000MM**  
*H82.67" X L39.37"*

**VERRE SATINÉ**  
*SATIN FINISH GLASS*



CRISTAL INCOLORE  
*CLEAR CRYSTAL*

10302200



2012 - LALIQUE

Détails techniques et instructions de montage : cf fiche architecture. / *Technical datas & mounting instructions: see architecture files.*  
Autres formats sur demande (cf fiche architecture). / *Other dimensions on request (see architecture files).*

# PANNEAUX D'ESPACE - INTERIOR PANELS

## DAHLIA

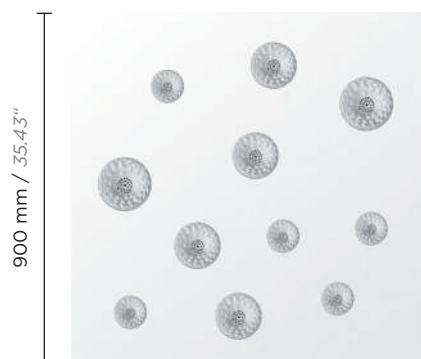

900 mm / 35.43"

35 kg / 77.16 pounds

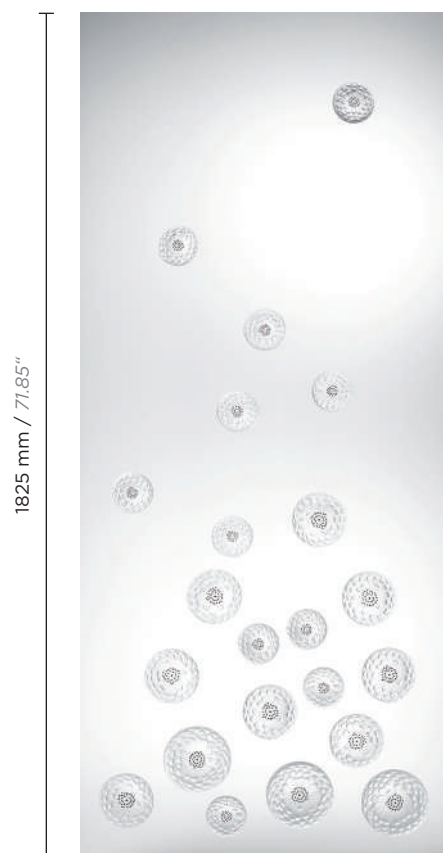

1825 mm / 71.85"

825 mm / 32.48"

47 kg / 103.62 pounds

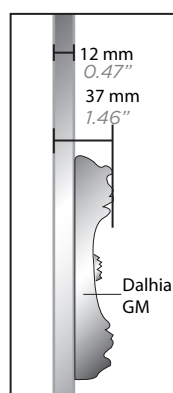

Épaisseur : 12 mm jusqu'à 37 mm  
au niveau du plus grand Dahlia en cristal.  
Thickness: 0.47" up to 1.46"  
for the largest crystal Dahlia.

### FINITION / FINISHING

			REFERENCE	EAN CODE	
<b>H900 x L900mm</b> L35.43" x L35.43"	<b>VERRE CLAIR</b> CLEAR GLASS		CRISTAL INCOLORE CLEAR CRYSTAL	10318900	
	<b>MIROIR</b> MIRROR		CRISTAL INCOLORE CLEAR CRYSTAL	10318800	
	<b>VERRE SATINÉ</b> SATIN FINISH GLASS		CRISTAL INCOLORE CLEAR CRYSTAL	10302300	
	<b>VERRE SATINÉ, MIROITÉ</b> MIRRORED, SATIN FINISH GLASS		CRISTAL INCOLORE CLEAR CRYSTAL	10302400	
<b>H1825 x L825 mm</b> H71.85" x L32.48"	<b>VERRE CLAIR</b> CLEAR GLASS		CRISTAL INCOLORE CLEAR CRYSTAL	10368000	
	<b>MIROIR</b> MIRROR		CRISTAL INCOLORE CLEAR CRYSTAL	10367800	
	<b>VERRE SATINÉ</b> SATIN FINISH GLASS		CRISTAL INCOLORE CLEAR CRYSTAL	10367600	
	<b>VERRE SATINÉ, MIROITÉ</b> MIRRORED, SATIN FINISH GLASS		CRISTAL INCOLORE CLEAR CRYSTAL	10367700	

2012 - LALIQUE

Détails techniques et instructions de montage : cf fiche architecture. / Technical datas & mounting instructions: see architecture files.

Autres formats sur demande (cf fiche architecture). / Other dimensions on request (see architecture files).

# PANNEAUX D'ESPACE - INTERIOR PANELS

## LANGUEDOC

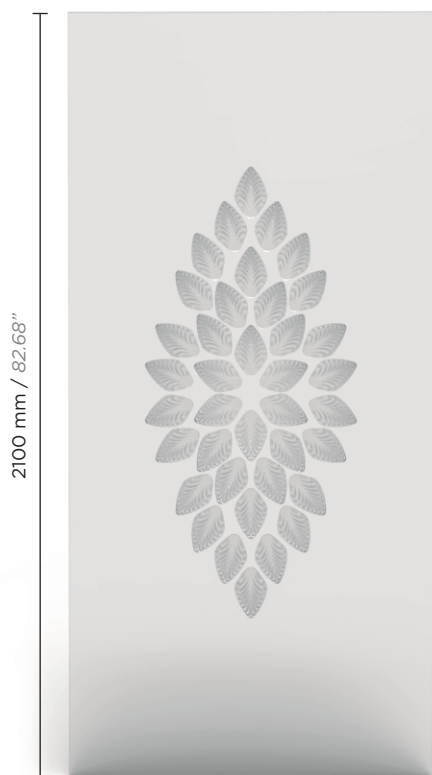

2100 mm / 82.68"

1000 mm / 39.37"

72 kg / 158.73 pounds

Panneau 2100 x 1000 mm - 38 cristaux  
Panel 2100 x 1000 mm - 38 crystals

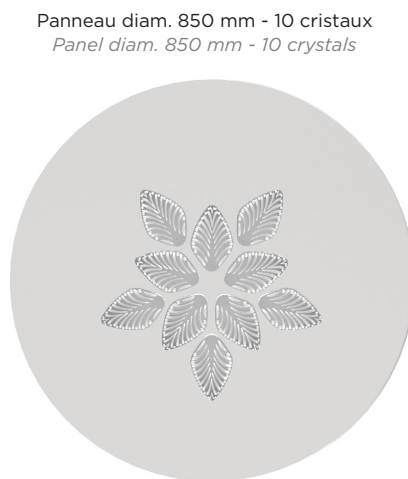

Panneau diam. 850 mm - 10 cristaux  
Panel diam. 850 mm - 10 crystals

Ø 850 mm / 33.46"

20 kg / 44.09 pounds

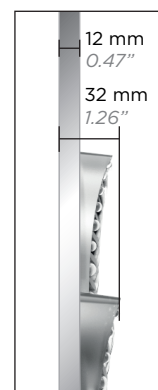

Épaisseur : 12 mm jusqu'à 32 mm  
au niveau du cristal.  
Thickness: 0.47" up to 1.26"  
for the largest crystal part.



2100 mm / 82.68"





700 mm / 27.56"

49 kg / 108.03 pounds

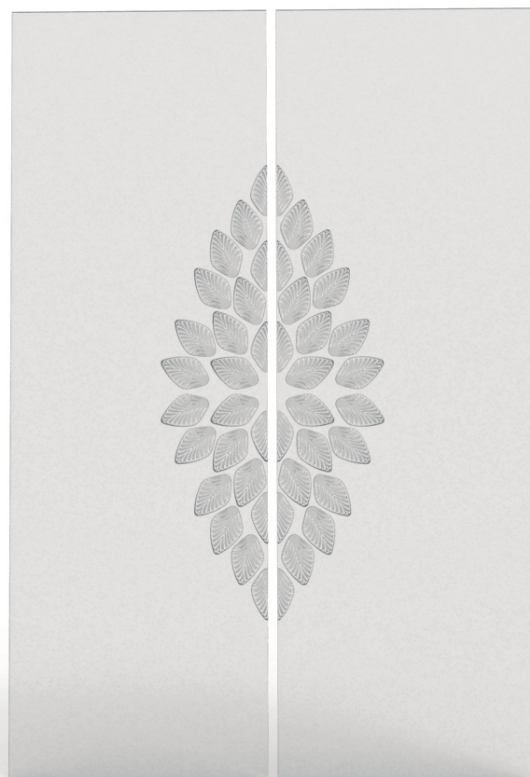
Panneau 2100 x 700 mm - 22 cristaux  
Présentation d'un panneau  
Panel 2100 x 700 mm - 22 crystals  
Presentation of one panel

Panneau 2100 x 700 mm  
22 cristaux  
Présentation de 2 panneaux  
en porte double.  
Commander 2 fois la même  
référence, elles sont réversibles.  
Panel 2100 x 700 mm  
22 crystals  
Presentation as a sliding door  
with 2 panels.  
Order twice the same reference,  
there are reversible.



FINITION / FINISHING		REFERENCE	EAN CODE
<b>2100 x 700 mm</b> <i>82.68" x 27.56"</i> 	<b>VERRE CLAIR</b> <i>CLEAR GLASS</i>	 CRISTAL INCOLORE <i>CLEAR CRYSTAL</i>	10510300 
	<b>VERRE MIROIR</b> <i>MIRROR GLASS</i>	 CRISTAL INCOLORE <i>CLEAR CRYSTAL</i>	10510400 
	<b>VERRE SATINÉ</b> <i>SATIN FINISH GLASS</i>	 CRISTAL INCOLORE <i>CLEAR CRYSTAL</i>	10510500 
	<b>VERRE SATINÉ MIROITÉ</b> <i>MIRRORED, SATIN FINISH GLASS</i>	 CRISTAL INCOLORE <i>CLEAR CRYSTAL</i>	10510600 
<b>2100 x 1000 mm</b> <i>82.68" x 39.37"</i> 	<b>VERRE CLAIR</b> <i>CLEAR GLASS</i>	 CRISTAL INCOLORE <i>CLEAR CRYSTAL</i>	10509900 
	<b>VERRE MIROIR</b> <i>MIRROR GLASS</i>	 CRISTAL INCOLORE <i>CLEAR CRYSTAL</i>	10510000 
	<b>VERRE SATINÉ</b> <i>SATIN FINISH GLASS</i>	 CRISTAL INCOLORE <i>CLEAR CRYSTAL</i>	10510100 
	<b>VERRE SATINÉ MIROITÉ</b> <i>MIRRORED, SATIN FINISH GLASS</i>	 CRISTAL INCOLORE <i>CLEAR CRYSTAL</i>	10510200 
<b>Ø 850 mm</b> <i>Ø 33.46"</i> 	<b>VERRE CLAIR</b> <i>CLEAR GLASS</i>	 CRISTAL INCOLORE <i>CLEAR CRYSTAL</i>	10509500 
	<b>VERRE MIROIR</b> <i>MIRROR GLASS</i>	 CRISTAL INCOLORE <i>CLEAR CRYSTAL</i>	10509600 
	<b>VERRE SATINÉ</b> <i>SATIN FINISH GLASS</i>	 CRISTAL INCOLORE <i>CLEAR CRYSTAL</i>	10509700 
	<b>VERRE SATINÉ MIROITÉ</b> <i>MIRRORED, SATIN FINISH GLASS</i>	 CRISTAL INCOLORE <i>CLEAR CRYSTAL</i>	10509800 

2015 - LALIQUE

Détails techniques et instructions de montage : cf fiche architecture. / Technical datas & mounting instructions: see architecture files.



# PANNEAUX D'ESPACE - INTERIOR PANELS

## VENISE

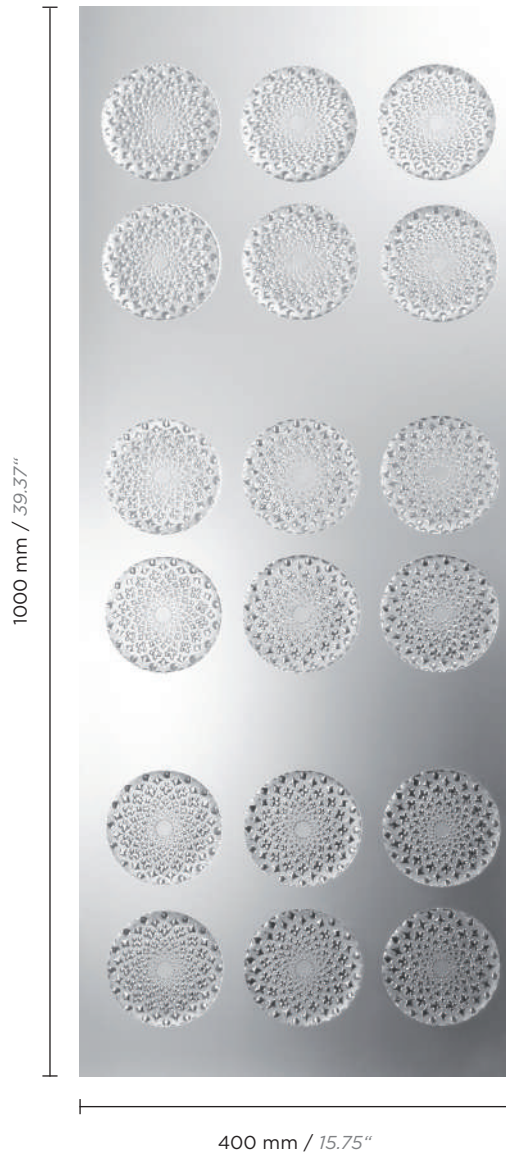

15 kg / 33.07 pounds

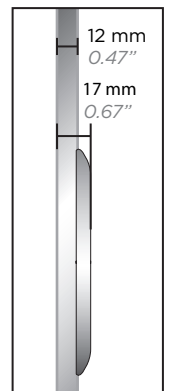

Épaisseur 12 mm - jusqu'à 17 mm  
au niveau du cristal.  
Thickness 0.47" - up to 0.67"  
for the crystal tops.

### FINITION / FINISHING

**VERRE CLAIR**  
CLEAR GLASS



CRISTAL INCOLORE  
CLEAR CRYSTAL

REFERENCE

10368200

EAN CODE



**MIROIR**  
MIRROR



CRISTAL INCOLORE  
CLEAR CRYSTAL

10368100



**VERRE SATINÉ**  
SATIN FINISH GLASS



CRISTAL INCOLORE  
CLEAR CRYSTAL

10319800



**VERRE SATINÉ, MIROITÉ**  
MIRRORED, SATIN FINISH GLASS



CRISTAL INCOLORE  
CLEAR CRYSTAL

10319900



2013 - LALIQUE

Détails techniques et instructions de montage : cf fiche architecture. / Technical datas & mounting instructions: see architecture files.  
Autres formats sur demande (cf fiche architecture). / Other dimensions on request (see architecture files).W

# ÉCHANTILLONS - SAMPLES

## BOUQUET



### FINITION / FINISHING

FINITION / FINISHING		REFERENCE	EAN CODE
<b>H170 x L170 x E37 mm</b> <i>H6.69" x L6.69" x W1.46"</i>	<b>VERRE CLAIR</b> <i>CLEAR GLASS</i>	CRISTAL INCOLORE <i>CLEAR CRYSTAL</i> 10482300	 0 905921 91069 6
	<b>MIROIR</b> <i>MIRROR</i>	CRISTAL INCOLORE <i>CLEAR CRYSTAL</i> 10482400	 0 905921 91068 9
	<b>VERRE SATINÉ</b> <i>SATIN FINISH GLASS</i>	CRISTAL INCOLORE <i>CLEAR CRYSTAL</i> 10482100	 0 905921 91071 9
	<b>VERRE SATINÉ, MIROITÉ</b> <i>MIRRORED, SATIN FINISH GLASS</i>	CRISTAL INCOLORE <i>CLEAR CRYSTAL</i> 10482200	 0 905921 91070 2

## DAHLIA



### FINITION / FINISHING

FINITION / FINISHING		REFERENCE	EAN CODE
<b>H170 x L170 x E37 mm</b> <i>H6.69" x L6.69" x W1.46"</i>	<b>VERRE CLAIR</b> <i>CLEAR GLASS</i>	CRISTAL INCOLORE <i>CLEAR CRYSTAL</i> 10481300	 0 905921 91078 8
	<b>MIROIR</b> <i>MIRROR</i>	CRISTAL INCOLORE <i>CLEAR CRYSTAL</i> 10481400	 0 905921 91077 1
	<b>VERRE SATINÉ</b> <i>SATIN FINISH GLASS</i>	CRISTAL INCOLORE <i>CLEAR CRYSTAL</i> 10360300	 0 905921 92348 1
	<b>VERRE SATINÉ, MIROITÉ</b> <i>MIRRORED, SATIN FINISH GLASS</i>	CRISTAL INCOLORE <i>CLEAR CRYSTAL</i> 10360400	 0 905921 92347 4

# ÉCHANTILLONS - SAMPLES

## LANGUEDOC



FINITION / FINISHING		REFERENCE	EAN CODE
<b>H170 x L170 x E37 mm</b> <i>H6.69" x L6.69" x W1.46"</i>	<b>VERRE CLAIR</b> <i>CLEAR GLASS</i>	 <b>CRISTAL INCOLORE</b> <i>CLEAR CRYSTAL</i>	10510700 
	<b>MIROIR</b> <i>MIRROR</i>	 <b>CRISTAL INCOLORE</b> <i>CLEAR CRYSTAL</i>	10510800 
	<b>VERRE SATINÉ</b> <i>SATIN FINISH GLASS</i>	 <b>CRISTAL INCOLORE</b> <i>CLEAR CRYSTAL</i>	10510900 
	<b>VERRE SATINÉ, MIROITÉ</b> <i>MIRRORED, SATIN FINISH GLASS</i>	 <b>CRISTAL INCOLORE</b> <i>CLEAR CRYSTAL</i>	10511000 

## VENISE



FINITION / FINISHING		REFERENCE	EAN CODE
<b>H170 x L170 x E37 mm</b> <i>H6.69" x L6.69" x W1.46"</i>	<b>VERRE CLAIR</b> <i>CLEAR GLASS</i>	 <b>CRISTAL INCOLORE</b> <i>CLEAR CRYSTAL</i>	10360500 
	<b>MIROIR</b> <i>MIRROR</i>	 <b>CRISTAL INCOLORE</b> <i>CLEAR CRYSTAL</i>	10360600 
	<b>VERRE SATINÉ</b> <i>SATIN FINISH GLASS</i>	 <b>CRISTAL INCOLORE</b> <i>CLEAR CRYSTAL</i>	10481700 
	<b>VERRE SATINÉ, MIROITÉ</b> <i>MIRRORED, SATIN FINISH GLASS</i>	 <b>CRISTAL INCOLORE</b> <i>CLEAR CRYSTAL</i>	10481800 

LALIQUE

MAISON



LADY GREEN & PIETRO MINGARELLI

# GREEN & MINGARELLI DESIGN

DÉCORATEURS / INTERIOR DESIGNERS



**T**out a commencé avec Lalique il y a plus d'une dizaine d'années quand nous avons travaillé sur le yacht d'un client passionné d'Art Déco. Nous nous sommes immergés dans cette période et particulièrement dans les créations de René Lalique pour en comprendre l'esprit. Un challenge passionnant car il s'agissait d'intégrer harmonieusement le cristal Lalique dans du mobilier, des lampes et d'utiliser des vases et autres pièces en cristal aussi bien dans la chambre que dans le bar ou la salle de bain tout en exprimant notre expertise. Nous collaborons avec les meilleurs constructeurs de yachts italiens, ce sont des artisans parmi les plus exigeants en matière de finitions. Puis nous avons installé des pièces Lalique dans différents appartements et villas mais c'est notre travail sur un yacht de 65 mètres qui a attiré l'attention de Silvio Denz. Il y a trois ans et demi, nous avons commencé par dessiner des lampes, une crédence et quelques coussins, et aujourd'hui nous créons des pièces uniques. Nous avons réalisé en trois ans ce que nous aurions fait en dix normalement, presque quatre cents pièces au total, c'est incroyable. Au-delà d'être une collection de meubles, lampes, serviettes et linge de lit, Lalique Maison s'impose comme un style de vie. Cette collection puissante doit vivre avec la lumière. Les connaisseurs reconnaîtront immédiatement la touche unique. Il reste essentiel pour nous que chaque création trouve sa place dans le décor pour que l'un et l'autre se fassent écho.

Lalique s'inscrit désormais dans notre ADN, nous avons complètement assimilé ce savoir-faire dans nos projets. C'est une passion que nous déclinons au quotidien, jour après jour. Lorsque nous voyageons, toute chose peut devenir matière à réflexion, source d'inspiration, car nous savons jouer avec le cristal et transformer un dessin en prototype. C'est en permanence un « work in progress ».

*It all began with Lalique over a dozen years ago, when we worked on the yacht belonging to a client passionate about Art Deco. We immersed ourselves in this period - especially René Lalique's designs - to understand its spirit. It was an exciting challenge because it involved harmoniously incorporating the Lalique crystal pieces into the furniture, lamps and using also vases and others crystal pieces into the bedroom as well as into the bar or the bathroom, while expressing our expertise. We collaborate with the best Italian yacht builders, who are some of the most demanding craftsmen when it comes to finishes. We subsequently placed Lalique pieces in different apartments, villas, but it was our work on a 65 meter yacht that caught Silvio Denz's attention. Three and a half years ago, we started designing lamps, a credenza and some cushions, and we now have a collection of unique creations. In three years, we have achieved what would normally have taken us ten years, we created nearly four hundred pieces; it's incredible. Over and above being a collection of furniture, lamps, towels and bed linen, Lalique Maison embodies a lifestyle. This powerful collection interplays with light. Connoisseurs will immediately recognise the unique touch. For us, it remains essential that each piece finds its place in the decor to their mutual benefit.*

*Lalique is now part of our DNA, we have completely assimilated this know-how into our upcoming projects. It's a passion that we express on a daily basis, day after day. When we travel, anything can become a source of inspiration because we know how to play with the crystal and transform a design into a prototype. It's a constant work in progress.*

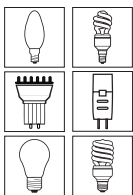

Ampoule fluorescente, halogène  
et LED E12 - E14 - E26 - E27 - G9 - G4 /  
*Fluorescent, halogène and LED  
bulb E12 - E14 - E26 - E27 - G9 - G4*

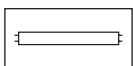

Tube fluorescent / *Fluorescent tube*

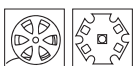

Disques, bandes de LEDs /  
*LED disks, strips*

**EU**

Branchement Europe /  
*Europe plug*

**US**

Branchement USA /  
*USA plug*

**UK**

Branchement Royaume-Uni /  
*United Kingdom plug*

**CE**

Certifié norme CE (230V Europe) /  
*Certified CE standard (230V Europe)*

**UL**

Certifié norme UL (120V US) /  
*Certified UL standard (120V US)*

**IP20**

**IP30**

Ce produit est conçu pour une utilisation intérieure. Il n'est pas destiné à être installé dans une salle de bain ou dans des locaux humides. Le luminaire ne doit pas entrer en contact avec l'eau. /

*This product is designed for internal use. It is not intended to be installed in a bathroom or other damp premises. The light-fitting must not be in contact with water.*



La finition « chromée » correspond dans le catalogue à un rendu argenté.  
*The "chrome" finishing in the catalogue corresponds to a silver rendering.*

LUMINAIRES - *LIGHTINGS*





## FEMME BRAS LEVÉS

ÉDITION NUMÉROTÉE / NUMBERED EDITION



14 kg / 30.90 pounds

Incolore / Clear  
Acier poli / Polished steel



Incolore et chromé / Clear and chrome  
Acier poli / Polished steel

### FINITION / FINISHING



CRISTAL INCOLORE - CLEAR CRYSTAL  
ACIER POLI - POLISHED STEEL

### REFERENCE

**EUROPE**  
10156500

### EAN CODE



CRISTAL INCOLORE - CLEAR CRYSTAL  
ACIER POLI - POLISHED STEEL

**US**  
10156600



CRISTAL INCOLORE - CLEAR CRYSTAL  
ACIER POLI - POLISHED STEEL

**UK**  
10156700



### 2011 - LADY TINA GREEN & PIETRO MINGARELLI POUR LALIQUE



INCOLORE ET CHROMÉ - CLEAR AND CHROME  
ACIER POLI - POLISHED STEEL

**EUROPE**  
10156712



INCOLORE ET CHROMÉ - CLEAR AND CHROME  
ACIER POLI - POLISHED STEEL

**US**  
10156711



INCOLORE ET CHROMÉ - CLEAR AND CHROME  
ACIER POLI - POLISHED STEEL

**UK**  
10156710



### 2013 - LADY TINA GREEN & PIETRO MINGARELLI POUR LALIQUE



LED x 4 - 24 watts - 2500 lumens

CE IP20

4000°K - Lumière Neutre - Neutral light

JOUEUR DE PIPEAU

ÉDITION NUMÉROTÉE / *NUMBERED EDITION*



FINITION / FINISHING



CRISTAL INCOLORE - *CLEAR CRYSTAL*  
ACIER POLI - *POLISHED STEEL*



CRISTAL INCOLORE - *CLEAR CRYSTAL*  
ACIER POLI - *POLISHED STEEL*

CRISTAL INCOLORE - *CLEAR CRYSTAL*  
ACIER POLI - *POLISHED STEEL*

REFERENCE

**EUROPE**  
10157100

**US**  
10157200

**UK**  
10161500

EAN CODE



LED x 4 - 24 watts - 2500 lumens

CE IP20

4000°K - Lumière neutre - *Neutral light*

## MERLES ET RAISINS

ÉDITION NUMÉROTÉE / NUMBERED EDITION



### FINITION / FINISHING



CRISTAL INCOLORE - CLEAR CRYSTAL  
ACIER POLI - POLISHED STEEL



CRISTAL INCOLORE - CLEAR CRYSTAL  
ACIER POLI - POLISHED STEEL

CRISTAL INCOLORE - CLEAR CRYSTAL  
ACIER POLI - POLISHED STEEL

### REFERENCE

**EUROPE**  
10156800

**US**  
10156900

**UK**  
10157000

### EAN CODE



LED x 4 - 24 watts - 2900 lumens

CE IP20

4000°K - Lumière neutre - Neutral light

2011 - LADY TINA GREEN & PIETRO MINGARELLI POUR LALIQUE



Ø 550 mm / 21.65"

170 mm / 6.69"

270 mm / 10.63"

11 kg / 24.30 pounds



### LAMPE HORS ABAT-JOUR

Hauteur x Longueur x Largeur - Poids :  
590 x 270 x 170 mm - 10,5 kg

### LAMP WITHOUT LAMPSHADE

Height x Length x Width - Weight:  
23.23" x 10.63" x 6.69" - 23.15 pounds

#### FINITION / FINISHING

#### REFERENCE

#### EAN CODE



CRISTAL INCOLORE - CLEAR CRYSTAL  
ACIER POLI - POLISHED STEEL

**EUROPE**  
10156200



CRISTAL INCOLORE - CLEAR CRYSTAL  
ACIER POLI - POLISHED STEEL

**US**  
10156300



CRISTAL INCOLORE - CLEAR CRYSTAL  
ACIER POLI - POLISHED STEEL

**UK**  
10156400



E26-E27 x 2 - max 40watts



Lampe livrée sans abat-jour et sans ampoule / Lamp delivered without lampshade and without bulb

#### 2011 - LADY TINA GREEN & PIETRO MINGARELLI POUR LALIQUE



### ABAT-JOUR

Hauteur x Diamètre - Poids :  
300 x 550 mm - 0,5 kg

### LAMPSHADE

Height x Diameter - Weight:  
11.81" x 21.65" - 1.1 pounds

#### FINITION / FINISHING

#### REFERENCE

#### EAN CODE



SOIE IVOIRE / INTÉRIEUR IVOIRE  
IVORY SILK / INSIDE IVORY

10161800



SOIE NOIRE / INTÉRIEUR ARGENT  
BLACK SILK / INSIDE SILVER

10161900



#### 2011 - LADY TINA GREEN & PIETRO MINGARELLI POUR LALIQUE

# LAMPES - LAMPS

## RAISINS

GM / LS

ÉDITION NUMÉROTÉE / NUMBERED EDITION



### LAMPE HORS ABAT-JOUR

Hauteur x Longueur x Largeur :  
654 x 300 x 300 mm

### LAMP WITHOUT LAMPSHADE

Height x Length x Width:  
25.75" x 11.81" x 11.81"

300 mm / 11.81"  
17 kg / 37.47 pounds

#### FINITION / FINISHING

#### REFERENCE

#### EAN CODE

	CRISTAL INCOLORE - CLEAR CRYSTAL ACIER POLI - POLISHED STEEL	<b>EUROPE</b> 10155900	 7 640111 494560
	CRISTAL INCOLORE - CLEAR CRYSTAL ACIER POLI - POLISHED STEEL	<b>US</b> 10156000	 7 640111 494584
	CRISTAL INCOLORE - CLEAR CRYSTAL ACIER POLI - POLISHED STEEL	<b>UK</b> 10156100	 7 640111 494591

#### 2011 - LADY TINA GREEN & PIETRO MINGARELLI POUR LALIQUE

	CRISTAL LUSTRÉ OR - GOLD LUSTER CRYSTAL DORÉ SATINÉ - SATIN GILDED	<b>EUROPE</b> 76111021	 7 640182 871635
	CRISTAL LUSTRÉ OR - GOLD LUSTER CRYSTAL DORÉ SATINÉ - SATIN GILDED	<b>US</b> 76131021	 7 640182 871659
	CRISTAL LUSTRÉ OR - GOLD LUSTER CRYSTAL DORÉ SATINÉ - SATIN GILDED	<b>UK</b> 76121021	 7 640182 871642

#### 2019 - LADY TINA GREEN & PIETRO MINGARELLI POUR LALIQUE

Lampe livrée sans abat-jour et sans ampoule /  
Lamp delivered without lampshade and without bulb



### ABAT-JOUR

Hauteur x Diamètre :  
311 x 700 mm

### LAMPSHADE

Height x Diameter:  
12.24" x 27.56"



E26-E27 x 2 - max 40 watts

#### FINITION / FINISHING

#### REFERENCE

#### EAN CODE

	SOIE IVOIRE / INTÉRIEUR IVOIRE IVORY SILK / INSIDE IVORY	10161600	 7 640111 494638
	SOIE NOIRE / INTÉRIEUR ARGENT BLACK SILK / INSIDE SILVER	10161700	 7 640111 494652

#### 2011 - LADY TINA GREEN & PIETRO MINGARELLI POUR LALIQUE



10 kg / 22.05 pounds

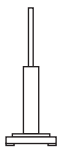





**LAMPE HORS ABAT-JOUR**

Hauteur x Longueur x Largeur - Poids  
630 x 240 x 240 mm - 10 kg

**LAMP WITHOUT LAMPSHADE**

Height x Length x Width - Weight:  
24.80" x 9.44" x 9.44" - 22.05 pounds

FINITION / FINISHING	REFERENCE	EAN CODE
 CRISTAL INCOLORE - CLEAR CRYSTAL CHROMÉ - CHROME	<b>EUROPE</b> 76111110	 7 640163 973600
 CRISTAL INCOLORE - CLEAR CRYSTAL CHROMÉ - CHROME	<b>US</b> 76121110	 7 640163 973723
CRISTAL INCOLORE - CLEAR CRYSTAL CHROMÉ - CHROME	<b>UK</b> 76131110	 7 640163 973716



E26-E27 x 2 - max 40 watts

CE IP20

Lampe livrée sans abat-jour et sans ampoule / Lamp delivered without lampshade and without bulb

**2017 - LADY TINA GREEN & PIETRO MINGARELLI POUR LALIQUE**

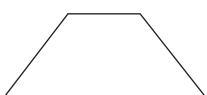

**ABAT-JOUR**

Hauteur x Longueur x Largeur - Poids :  
160 x 360 x 360 mm

**LAMPSHADE**

Height x Length x Width - Weight:  
6.29" x 14.17" x 14.17"

FINITION / FINISHING	REFERENCE	EAN CODE
 SOIE IVOIRE / INTÉRIEUR IVOIRE IVORY SILK / INSIDE IVORY	76300890	 7 640163 973617

2006 - LALIQUE

# LAMPES - LAMPS

RAISINS  
PM / SS

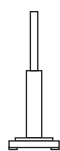

**LAMPE HORS ABAT-JOUR**

Hauteur x Longueur x Largeur - Poids  
630 x 240 x 240 mm - 10 kg

**LAMP WITHOUT LAMPSHADE**

Height x Length x Width - Weight:  
24.80" x 9.44" x 9.44" - 22.05 pounds

FINITION / FINISHING	REFERENCE	EAN CODE
 <p>CRISTAL LUSTRÉ OR - <i>GOLD LUSTER CRYSTAL</i> FINITION SATINÉE DORÉE - <i>GOLDEN SATIN FINISHING</i></p>	<p><b>EUROPE</b> 76111120</p>	 7 640182 870102
 <p>CRISTAL LUSTRÉ OR - <i>GOLD LUSTER CRYSTAL</i> FINITION SATINÉE DORÉE - <i>GOLDEN SATIN FINISHING</i></p>	<p><b>US</b> 76121120</p>	 7 640182 870126
<p>CRISTAL LUSTRÉ OR - <i>GOLD LUSTER CRYSTAL</i> FINITION SATINÉE DORÉE - <i>GOLDEN SATIN FINISHING</i></p>	<p><b>UK</b> 76131120</p>	 7 640182 870119



E26-E27 - 2 x 40 watts

CE IP20

Lampe livrée sans abat-jour et sans ampoule / Lamp delivered without lampshade and without bulb

**2018 - LADY TINA GREEN & PIETRO MINGARELLI POUR LALIQUE**

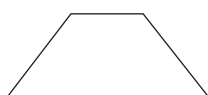

**ABAT-JOUR**

Hauteur x Longueur x Largeur :  
160 x 360 x 360 mm

**LAMPSHADE**

Height x Length x Width :  
6.29" x 14.17" x 14.17"

FINITION / FINISHING	REFERENCE	EAN CODE
 <p>SOIE IVOIRE / INTÉRIEUR IVOIRE IVORY SILK / INSIDE IVORY</p>	<p>76300890</p>	 7 640163 973617

**2006 - LALIQUE**

TABLES & MEUBLES DE RANGEMENT  
*TABLES & CABINETS*





# ARMOIRES - CABINETS

## FEMME BRAS LEVÉS

AVEC TRINGLE DE VÊTEMENTS / WITH CLOTHES RAIL

ÉDITION NUMÉROTÉE / NUMBERED EDITION



Dimensions incluant les poignées en cristal. /  
Dimensions including the crystal handles.

**263 kg / 579.80 pounds**

FINITION / FINISHING

REFERENCE

EAN CODE



CRISTAL INCOLORE - CLEAR CRYSTAL  
NOYER - WALNUT  
ACIER DORÉ SATINÉ - INOX GOLDEN SATIN STEEL

72585003



7 640163 974621

**2015 - LADY TINA GREEN & PIETRO MINGARELLI POUR LALIQUE**

# ARMOIRES - CABINETS

## MERLES & RAISINS AVEC ÉTAGÈRES EN VERRE / WITH GLASS SHELVES ÉDITION NUMÉROTÉE / NUMBERED EDITION

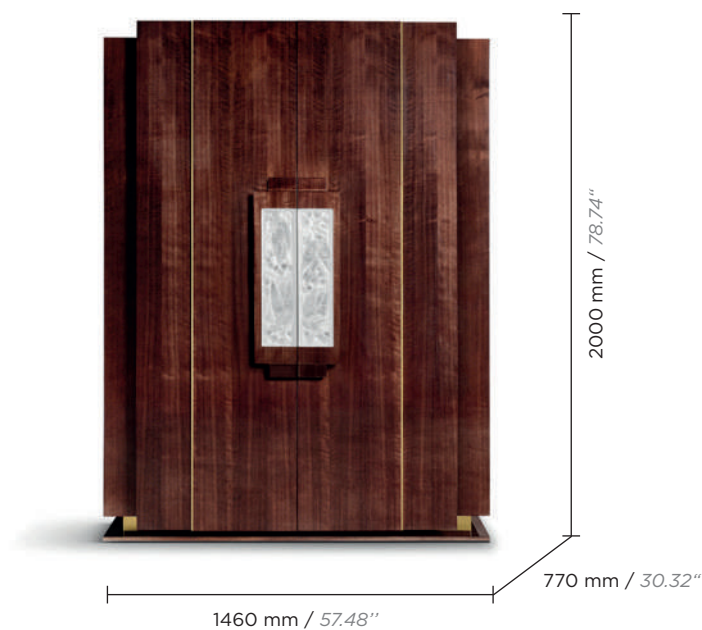

Dimensions incluant les poignées en cristal. /  
Dimensions including the crystal handles.

263 kg / 579.80 pounds

FINITION / FINISHING

REFERENCE

EAN CODE



CRISTAL INCOLORE - CLEAR CRYSTAL  
NOYER - WALNUT  
ACIER DORÉ SATINÉ - INOX GOLDEN SATIN STEEL

72584000



7 640163 974638

2015 - LADY TINA GREEN & PIETRO MINGARELLI POUR LALIQUE

# BARS - BARS

## DRAGON

SANS TIROIR LATÉRAL / *WITHOUT SIDE DRAWER*

ÉDITION NUMÉROTÉE / *NUMBERED EDITION*

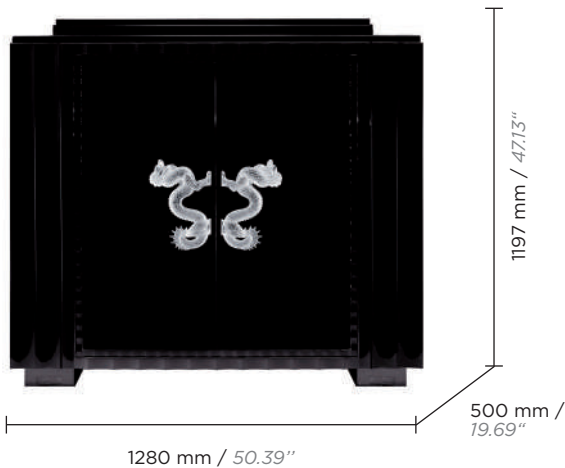

**PM / SS**

**114 kg / 251.30 pounds**

Dimensions incluant les poignées en cristal. /  
*Dimensions including the crystal handles.*



**GM / LS**

**150 kg / 330.70 pounds**

Dimensions incluant les poignées en cristal. /  
*Dimensions including the crystal handles.*

FINITION / *FINISHING*

REFERENCE

EAN CODE



**PM / SS**



CRISTAL INCOLORE - *CLEAR CRYSTAL*  
ÉBÈNE NOIR - *BLACK EBONY*

10179205



7 640111 508458

**2014 - LADY TINA GREEN & PIETRO MINGARELLI POUR LALIQUE**



CRISTAL INCOLORE - *CLEAR CRYSTAL*  
ÉBÈNE NATUREL - *NATURAL EBONY*

10179200



7 640111 493747



CRISTAL INCOLORE - *CLEAR CRYSTAL*  
FRÈNE IVOIRE - *IVORY ASH*

10179300



7 640111 493754

**2011 - LADY TINA GREEN & PIETRO MINGARELLI POUR LALIQUE**



**GM / LS**



CRISTAL INCOLORE - *CLEAR CRYSTAL*  
ÉBÈNE NATUREL - *NATURAL EBONY*

10179210



7 640111 506270

**2013 - LADY TINA GREEN & PIETRO MINGARELLI POUR LALIQUE**



CRISTAL INCOLORE - *CLEAR CRYSTAL*  
LAQUÉ NOIR - *BLACK LACQUERED*

72119000



7 640163 972689

**2016 - LADY TINA GREEN & PIETRO MINGARELLI POUR LALIQUE**

# BARS - BARS



## FEMME BRAS LEVÉS AVEC TIROIRS LATÉRAUX / WITH SIDE DRAWERS ÉDITION NUMÉROTÉE / NUMBERED EDITION

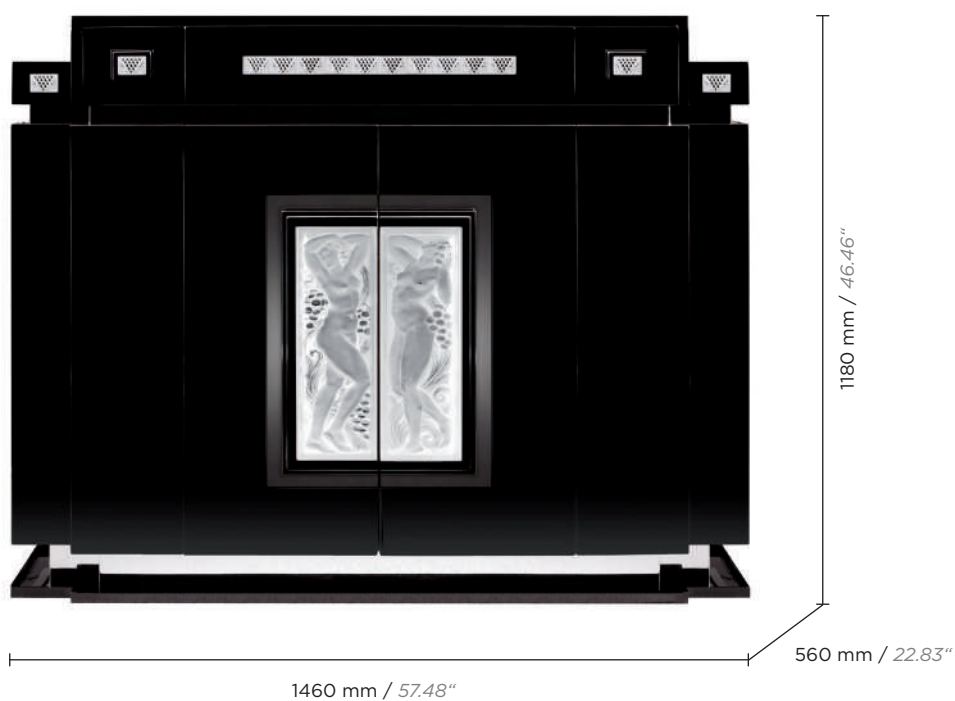





183 kg / 403.40 pounds

Dimensions incluant les poignées en cristal. /  
Dimensions including the crystal handles.

### FINITION / FINISHING

### REFERENCE

### EAN CODE

	CRISTAL INCOLORE - CLEAR CRYSTAL ÉBÈNE NOIR - BLACK EBONY	10178800	 7 640111 505341
	CRISTAL INCOLORE - CLEAR CRYSTAL FRÊNE IVOIRE - IVORY ASH	10178900	 7 640111 493792
<b>2011 - LADY TINA GREEN &amp; PIETRO MINGARELLI POUR LALIQUE</b>			
	CRISTAL INCOLORE - CLEAR CRYSTAL ÉBÈNE NATUREL - NATURAL EBONY	10178850	 7 640111 508311
<b>2013 - LADY TINA GREEN &amp; PIETRO MINGARELLI POUR LALIQUE</b>			
	CRISTAL INCOLORE - CLEAR CRYSTAL BLEU EUCALYPTUS - BLUE EUCALYPTUS	72155000	 7 640163 975918
<b>2015 - LADY TINA GREEN &amp; PIETRO MINGARELLI POUR LALIQUE</b>			





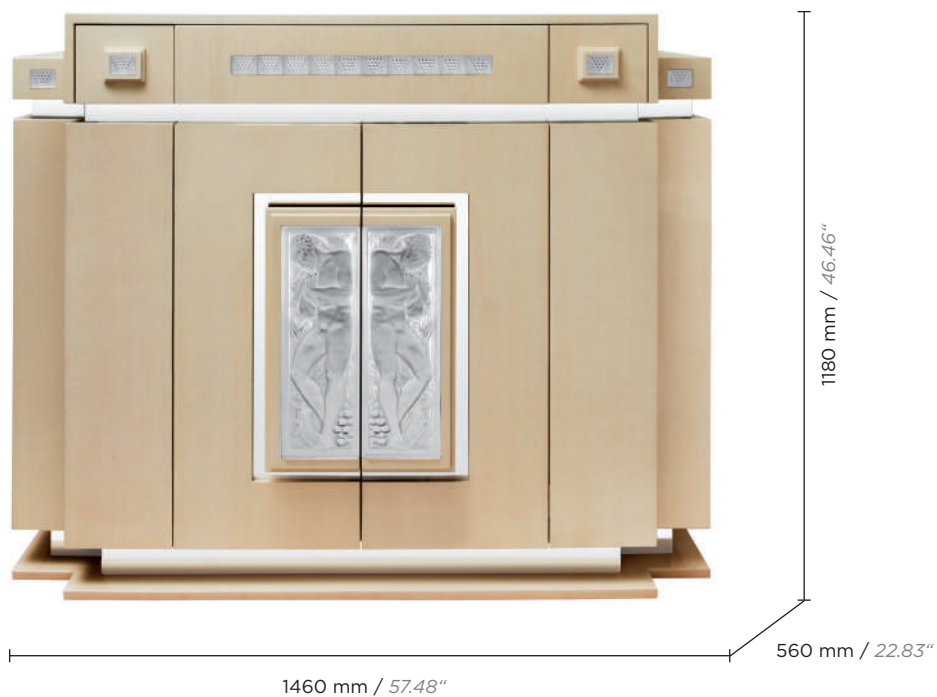







# BARS - BARS

## JOUEUR DE PIPEAU AVEC TIROIRS LATÉRAUX / WITH SIDE DRAWERS ÉDITION NUMÉROTÉE / NUMBERED EDITION



183 kg / 403.40 pounds

Dimensions incluant les poignées en cristal. /  
Dimensions including the crystal handles.

FINITION / FINISHING	REFERENCE	EAN CODE
  CRISTAL INCOLORE - CLEAR CRYSTAL ÉBÈNE NOIR - BLACK EBONY	10179400	 7 640111 493815
  CRISTAL INCOLORE - CLEAR CRYSTAL FRÈNE IVOIRE - IVORY ASH	10179500	 7 640111 493822
<b>2011 - LADY TINA GREEN &amp; PIETRO MINGARELLI POUR LALIQUE</b>		
  CRISTAL INCOLORE - CLEAR CRYSTAL ÉBÈNE NATUREL - NATURAL EBONY	10179450	 7 640111 508328
<b>2013 - LADY TINA GREEN &amp; PIETRO MINGARELLI POUR LALIQUE</b>		
  CRISTAL INCOLORE - CLEAR CRYSTAL BLEU EUCALYPTUS - BLUE EUCALYPTUS	72153000	 7 640163 978896
<b>2015 - LADY TINA GREEN &amp; PIETRO MINGARELLI POUR LALIQUE</b>		

# BARS - BARS

LONGCHAMP  
SANS TIROIR LATÉRAL / *WITHOUT SIDE DRAWER*  
ÉDITION NUMÉROTÉE / *NUMBERED EDITION*



150 kg / 330.70 pounds

Dimensions incluant les poignées en cristal. /  
*Dimensions including the crystal handles.*

## FINITION / FINISHING

## REFERENCE

## EAN CODE



CRISTAL INCOLORE - *CLEAR CRYSTAL*  
ÉBÈNE NATUREL - *NATURAL EBONY*

10178605



CRISTAL INCOLORE - *CLEAR CRYSTAL*  
ÉBÈNE NOIR - *BLACK EBONY*

10178610



CRISTAL INCOLORE - *CLEAR CRYSTAL*  
FRÈNE IVOIRE - *IVORY ASH*

72147000



## 2014 - LADY TINA GREEN & PIETRO MINGARELLI POUR LALIQUE



CRISTAL INCOLORE - *CLEAR CRYSTAL*  
BLEU EUCALYPTUS - *BLUE EUCALYPTUS*

72157000



## 2019 - LADY TINA GREEN & PIETRO MINGARELLI POUR LALIQUE





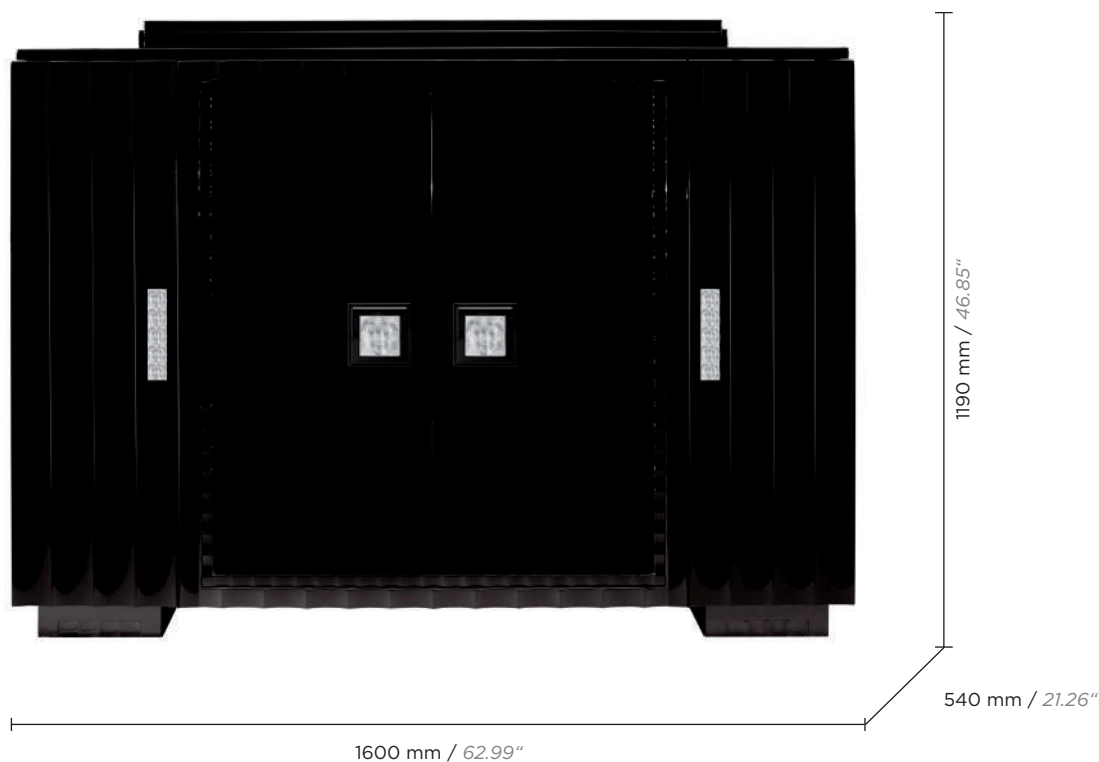



# BARS - BARS

## MASQUE DE FEMME SANS TIROIR LATÉRAL / *WITHOUT SIDE DRAWER* ÉDITION NUMÉROTÉE / *NUMBERED EDITION*



150 kg / 330.70 pounds

Dimensions incluant les poignées en cristal. /  
*Dimensions including the crystal handles.*

FINITION / FINISHING	REFERENCE	EAN CODE
  CRISTAL INCOLORE - <i>CLEAR CRYSTAL</i> ÉBÈNE NOIR - <i>BLACK EBONY</i>	10179000	 7 640111 493761
  CRISTAL INCOLORE - <i>CLEAR CRYSTAL</i> FRÊNE IVOIRE - <i>IVORY ASH</i>	10179100	 7 640111 493778
<b>2011 - LADY TINA GREEN &amp; PIETRO MINGARELLI POUR LALIQUE</b>		
  CRISTAL INCOLORE - <i>CLEAR CRYSTAL</i> ÉBÈNE NATUREL - <i>NATURAL EBONY</i>	10179050	 7 640111 508304
<b>2013 - LADY TINA GREEN &amp; PIETRO MINGARELLI POUR LALIQUE</b>		

# BARS - BARS

MERLES ET RAISINS  
 AVEC TIROIRS LATÉRAUX /  
 WITH SIDE DRAWERS /  
 ÉDITION NUMÉROTÉE / NUMBERED EDITION



1180 mm / 46.46"

560 mm / 22.83"

1460 mm / 57.48"

183 kg / 403.40 pounds















Dimensions incluant les poignées en cristal. /  
 Dimensions including the crystal handles.



## FINITION / FINISHING

## REFERENCE

## EAN CODE

 	CRISTAL INCOLORE - CLEAR CRYSTAL ÉBÈNE NOIR - BLACK EBONY	10179600	 7 640111 493839
 	CRISTAL INCOLORE - CLEAR CRYSTAL FRÊNE IVOIRE - IVORY ASH	10179700	 7 640111 493846
<b>2011 - LADY TINA GREEN &amp; PIETRO MINGARELLI POUR LALIQUE</b>			
 	CRISTAL INCOLORE - CLEAR CRYSTAL ÉBÈNE NATUREL - NATURAL EBONY	10179605	 7 640111 506287
<b>2013 - LADY TINA GREEN &amp; PIETRO MINGARELLI POUR LALIQUE</b>			
 	CRISTAL INCOLORE - CLEAR CRYSTAL ÉBÈNE NATUREL - NATURAL EBONY ACIER DORÉ SATINÉ - INOX GOLDEN SATIN STEEL	72124002	 7 640163 974591
<b>2015 - LADY TINA GREEN &amp; PIETRO MINGARELLI POUR LALIQUE</b>			
 	CRISTAL LUSTRÉ OR - GOLD LUSTER CRYSTAL BOIS NATUREL - NATURAL WOOD ACIER DORÉ SATINÉ - INOX GOLDEN SATIN STEEL	72192000	 7 640182 870058
<b>2018 - LADY TINA GREEN &amp; PIETRO MINGARELLI POUR LALIQUE</b>			



# BARS - BARS

## RAISINS

ÉDITION NUMÉROTÉE / *NUMBERED EDITION*



FINITION / *FINISHING*

REFERENCE

EAN CODE



CRISTAL INCOLORE - *CLEAR CRYSTAL*  
LAQUÉ NOIR - *BLACK LACQUERED*  
TOP EN VERRE NOIR - *BLACK GLASS TOP*

10179610



7 640111 506294

**2013 - LADY TINA GREEN & PIETRO MINGARELLI POUR LALIQUE**

RAISINS

ÉDITION NUMÉROTÉE / *NUMBERED EDITION*



FINITION / *FINISHING*

REFERENCE

EAN CODE



CRISTAL INCOLORE - *CLEAR CRYSTAL*  
 LAQUÉ NOIR - *BLACK LACQUERED*  
 3 PORTES ARRIÈRES - *3 DOORS AT THE BACK*

72112410



2016 - LADY TINA GREEN & PIETRO MINGARELLI POUR LALIQUE

## RAISINS

ÉDITION NUMÉROTÉE / NUMBERED EDITION































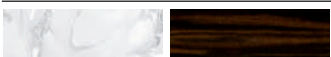

Laqué noir / Black lacquered

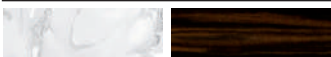

Ébène naturel / Natural ebony



FINITION / FINISHING	REFERENCE	EAN CODE
<b>L930 x I480</b> <b>x H2350 mm</b> <i>L36.61" x W18.90"</i> <i>x H92.52"</i>	 CRISTAL INCOLORE - <i>CLEAR CRYSTAL</i> LAQUÉ NOIR - <i>BLACK LACQUERED</i> <b>2013 - LADY TINA GREEN &amp; PIETRO MINGARELLI POUR LALIQUE</b>	10293410  7 640111 506614
	 CRISTAL INCOLORE - <i>CLEAR CRYSTAL</i> ÉBÈNE NATUREL - <i>NATURAL EBONY</i> <b>2014 - LADY TINA GREEN &amp; PIETRO MINGARELLI POUR LALIQUE</b>	10293411  7 640111 508564
	 CRISTAL INCOLORE - <i>CLEAR CRYSTAL</i> BLEU EUCALYPTUS - <i>BLUE EUCALYPTUS</i> <b>2016 - LADY TINA GREEN &amp; PIETRO MINGARELLI POUR LALIQUE</b>	72252120  7 640163 972818
<b>L1160 x I480</b> <b>x H2350 mm</b> <b>198 kg</b> <i>L45.66" x W18.90"</i> <i>x H92.52"</i> <i>436.5 pounds</i>	 CRISTAL INCOLORE - <i>CLEAR CRYSTAL</i> LAQUÉ NOIR - <i>BLACK LACQUERED</i> <b>2012 - LADY TINA GREEN &amp; PIETRO MINGARELLI POUR LALIQUE</b>	10293400  7 640111 496182
	 CRISTAL INCOLORE - <i>CLEAR CRYSTAL</i> ÉBÈNE NATUREL - <i>NATURAL EBONY</i> <b>2014 - LADY TINA GREEN &amp; PIETRO MINGARELLI POUR LALIQUE</b>	10293401  7 640111 508557
	 CRISTAL INCOLORE - <i>CLEAR CRYSTAL</i> BLEU EUCALYPTUS - <i>BLUE EUCALYPTUS</i> <b>2016 - LADY TINA GREEN &amp; PIETRO MINGARELLI POUR LALIQUE</b>	72252220  7 640163 972825
<b>L1700 x I480</b> <b>x H2350 mm</b> <i>L66.93" x W18.90"</i> <i>x H92.52"</i>	 CRISTAL INCOLORE - <i>CLEAR CRYSTAL</i> LAQUÉ NOIR - <i>BLACK LACQUERED</i> <b>2013 - LADY TINA GREEN &amp; PIETRO MINGARELLI POUR LALIQUE</b>	10293430  7 640111 506621
	 CRISTAL INCOLORE - <i>CLEAR CRYSTAL</i> ÉBÈNE NATUREL - <i>NATURAL EBONY</i> <b>2014 - LADY TINA GREEN &amp; PIETRO MINGARELLI POUR LALIQUE</b>	10293431  7 640111 508571
	 CRISTAL INCOLORE - <i>CLEAR CRYSTAL</i> BLEU EUCALYPTUS - <i>BLUE EUCALYPTUS</i> <b>2016 - LADY TINA GREEN &amp; PIETRO MINGARELLI POUR LALIQUE</b>	72251323  7 640163 972832
<b>L2250 x I480</b> <b>x H2350 mm</b> <i>L88.58" x W18.90"</i> <i>x H92.52"</i>	 CRISTAL INCOLORE - <i>CLEAR CRYSTAL</i> LAQUÉ NOIR - <i>BLACK LACQUERED</i> <b>2013 - LADY TINA GREEN &amp; PIETRO MINGARELLI POUR LALIQUE</b>	10293420  7 640111 506638
	 CRISTAL INCOLORE - <i>CLEAR CRYSTAL</i> ÉBÈNE NATUREL - <i>NATURAL EBONY</i> <b>2014 - LADY TINA GREEN &amp; PIETRO MINGARELLI POUR LALIQUE</b>	10293421  7 640111 508588
	 CRISTAL INCOLORE - <i>CLEAR CRYSTAL</i> BLEU EUCALYPTUS - <i>BLUE EUCALYPTUS</i> <b>2016 - LADY TINA GREEN &amp; PIETRO MINGARELLI POUR LALIQUE</b>	72252420  7 640163 972849
<b>L3300 x I480</b> <b>x H2350 mm</b> <b>465 kg</b> <i>L129.92" x W18.90"</i> <i>x H92.52"</i> <i>1025.15 pounds</i>	 CRISTAL INCOLORE - <i>CLEAR CRYSTAL</i> LAQUÉ NOIR - <i>BLACK LACQUERED</i> <b>2013 - LADY TINA GREEN &amp; PIETRO MINGARELLI POUR LALIQUE</b>	10293440  7 640111 506645
	 CRISTAL INCOLORE - <i>CLEAR CRYSTAL</i> ÉBÈNE NATUREL - <i>NATURAL EBONY</i> <b>2014 - LADY TINA GREEN &amp; PIETRO MINGARELLI POUR LALIQUE</b>	10293441  7 640111 508595
	 CRISTAL INCOLORE - <i>CLEAR CRYSTAL</i> BLEU EUCALYPTUS - <i>BLUE EUCALYPTUS</i> <b>2016 - LADY TINA GREEN &amp; PIETRO MINGARELLI POUR LALIQUE</b>	72252520  7 640163 972856

Bibliothèque livrée sans éclairage ni portes en verre. Les éclairages et portes en verre peuvent être commandés séparément. /  
 Library delivered without lightings neither glass doors. Lightings and glass doors can be ordered separately.

# BUREAUX - DESKS

## RAISINS

ÉDITION NUMÉROTÉE / *NUMBERED EDITION*

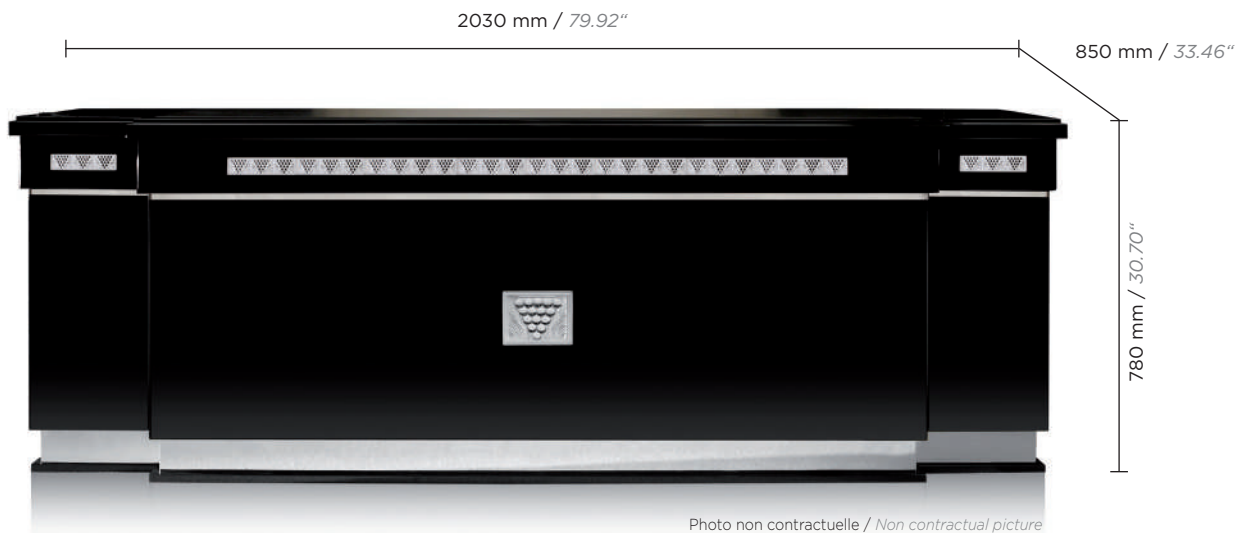

145 kg / 319.70 pounds

FINITION / *FINISHING*

REFERENCE

EAN CODE



CRISTAL INCOLORE - *CLEAR CRYSTAL*  
LAQUÉ NOIR - *BLACK LACQUERED*

10293500



**2012 - LADY TINA GREEN & PIETRO MINGARELLI POUR LALIQUE**



CRISTAL INCOLORE - *CLEAR CRYSTAL*  
BLEU EUCALYPTUS - *BLUE EUCALYPTUS*

72352000



**2015 - LADY TINA GREEN & PIETRO MINGARELLI POUR LALIQUE**

RAISINS

ÉDITION NUMÉROTÉE / *NUMBERED EDITION*



FINITION / *FINISHING*

REFERENCE

EAN CODE



CRISTAL INCOLORE - *CLEAR CRYSTAL*  
 LAQUÉ NOIR - *BLACK LACQUERED*  
 AVEC MIRROIR - *WITH MIRROR*

72612630



7 640163 973525

2016 - LADY TINA GREEN & PIETRO MINGARELLI POUR LALIQUE

# COIFFEUSES - *DRESSING TABLES*

## MASQUE DE FEMME

ÉDITION NUMÉROTÉE / *NUMBERED EDITION*



125 kg / 275.60 pounds

FINITION / <i>FINISHING</i>	REFERENCE	EAN CODE
 CRISTAL INCOLORE - <i>CLEAR CRYSTAL</i> LAQUÉ NOIR - <i>BLACK LACQUERED</i> <b>2013 - LADY TINA GREEN &amp; PIETRO MINGARELLI POUR LALIQUE</b>	10190020	 7 640111 506607
 CRISTAL INCOLORE - <i>CLEAR CRYSTAL</i> ÉBÈNE NATUREL - <i>NATURAL EBONY</i> TOP EN GRANITE NOIR - <i>BLACK GRANITE TOP</i> <b>2014 - LADY TINA GREEN &amp; PIETRO MINGARELLI POUR LALIQUE</b>	73421000	 7 640111 509301
 CRISTAL INCOLORE - <i>CLEAR CRYSTAL</i> FRÈNE IVOIRE - <i>IVORY ASH</i> TOP EN GRANITE NOIR - <i>BLACK GRANITE TOP</i> <b>2015 - LADY TINA GREEN &amp; PIETRO MINGARELLI POUR LALIQUE</b>	73441000	 7 640163 975475
 CRISTAL INCOLORE - <i>CLEAR CRYSTAL</i> BLEU EUCALYPTUS - <i>BLUE EUCALYPTUS</i> TOP EN GRANITE NOIR - <i>BLACK GRANITE TOP</i> <b>2018 - LADY TINA GREEN &amp; PIETRO MINGARELLI POUR LALIQUE</b>	73451000	 7 640163 973808

# COIFFEUSES - *DRESSING TABLES*

RAISINS



Photo non contractuelle / *Non contractual picture*

125 kg / 275.60 pounds

FINITION / *FINISHING*

REFERENCE

EAN CODE



CRISTAL INCOLORE - *CLEAR CRYSTAL*  
LAQUÉ NOIR - *BLACK LACQUERED*

73412000



7 640163 976212

2015 - LADY TINA GREEN & PIETRO MINGARELLI POUR LALIQUE



# COIFFEUSES - *DRESSING TABLES*

## RAISINS



125 kg / 275.60 pounds

FINITION / FINISHING

REFERENCE

EAN CODE



CRISTAL LUSTRÉ OR - *GOLD LUSTER CRYSTAL*  
BOIS NATUREL - *NATURAL WOOD*  
ACIER DORÉ SATINÉ - *INOX GOLDEN SATIN STEEL*

73462350



7 640182 870034

2018 - LADY TINA GREEN & PIETRO MINGARELLI POUR LALIQUE

# COMMODES - *DRAWER UNIT*

RAISINS

ÉDITION NUMÉROTÉE / *NUMBERED EDITION*



130 kg / 286.60 pounds

FINITION / *FINISHING*

REFERENCE

EAN CODE



CRISTAL INCOLORE - *CLEAR CRYSTAL*  
LAQUÉ NOIR - *BLACK LACQUERED*  
4 TIROIRS - *4 DRAWERS*

72712510



**2016 - LADY TINA GREEN & PIETRO MINGARELLI POUR LALIQUE**



CRISTAL INCOLORE - *CLEAR CRYSTAL*  
FRÈNE IVOIRE - *IVORY ASH*  
4 TIROIRS - *4 DRAWERS*

72742510



**2018 - LADY TINA GREEN & PIETRO MINGARELLI POUR LALIQUE**

# COMMODOES - *TALL BOY*

## MASQUE DE FEMME

6 TIROIRS / 6 *DRAWERS*

ÉDITION NUMÉROTÉE / *NUMBERED EDITION*



FINITION / *FINISHING*

REFERENCE

EAN CODE



CRISTAL INCOLORE - *CLEAR CRYSTAL*  
LAQUÉ NOIR - *BLACK LACQUERED*  
ACIER POLI - *POLISHED STEEL*

10190120



**2013 - LADY TINA GREEN & PIETRO MINGARELLI POUR LALIQUE**



CRISTAL INCOLORE - *CLEAR CRYSTAL*  
ÉBÈNE NATUREL - *NATURAL EBONY*  
ACIER POLI - *POLISHED STEEL*

73621000



**2014 - LADY TINA GREEN & PIETRO MINGARELLI POUR LALIQUE**

# COMMODOES - *TALL BOY*

RAISINS  
6 TIROIRS / 6 *DRAWERS*  
ÉDITION NUMÉROTÉE / *NUMBERED EDITION*

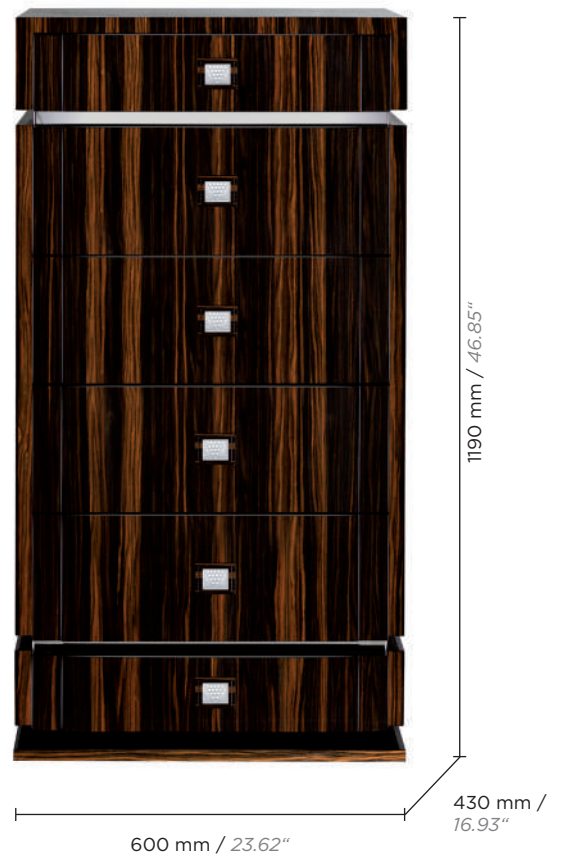

Photos non contractuelles / *Non contractual pictures*

FINITION / *FINISHING*

REFERENCE

EAN CODE



CRISTAL INCOLORE - *CLEAR CRYSTAL*  
ÉBÈNE NATUREL - *NATURAL EBONY*  
ACIER POLI - *POLISHED STEEL*

73622000



7 640163 975987

2014 - LADY TINA GREEN & PIETRO MINGARELLI POUR LALIQUE

# CONSOLES - CONSOLES

## LONGCHAMP

MM / MS

ÉDITION NUMÉROTÉE / NUMBERED EDITION



96 kg / 211.60 pounds

FINITION / FINISHING

REFERENCE

EAN CODE



CRISTAL INCOLORE - CLEAR CRYSTAL  
ÉBÈNE NATUREL - NATURAL EBONY  
TOP EN GRANITE NOIR - BLACK GRANITE TOP

11180210



7 640111 506560

2013 - LADY TINA GREEN & PIETRO MINGARELLI POUR LALIQUE

# CONSOLES - CONSOLES

## MASQUE DE FEMME

ÉDITION NUMÉROTÉE / *NUMBERED EDITION*

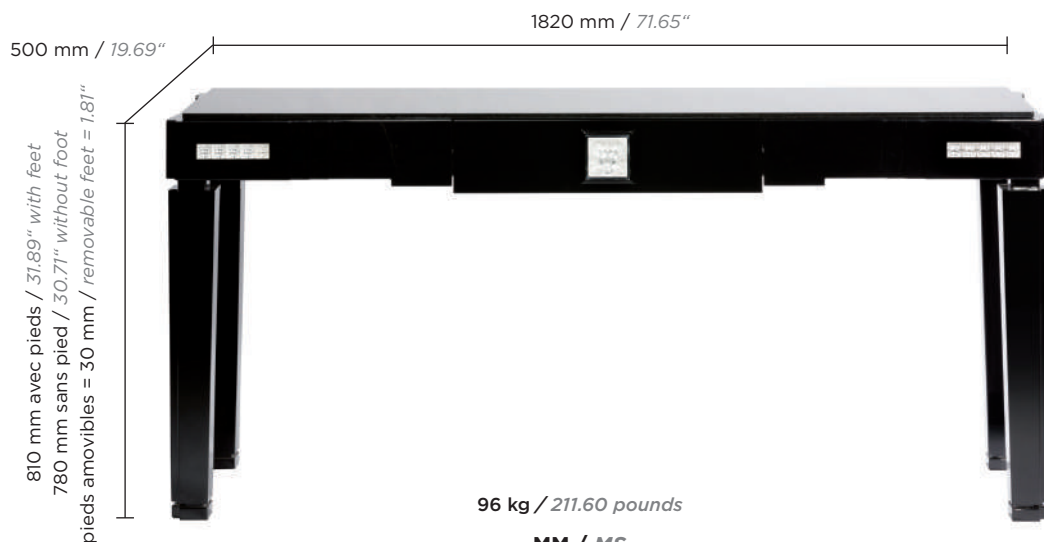

96 kg / 211.60 pounds

**MM / MS**

Laqué noir / *Black lacquered*



**GM / LS**

Frêne ivoire / *Ivory ash*

FINITION / *FINISHING*

REFERENCE

EAN CODE



CRISTAL INCOLORE - *CLEAR CRYSTAL*  
FRÊNE IVOIRE - *IVORY ASH*  
TOP EN GRANITE NOIR - *BLACK GRANITE TOP*

11180200



**2012 - LADY TINA GREEN & PIETRO MINGARELLI POUR LALIQUE**



CRISTAL INCOLORE - *CLEAR CRYSTAL*  
LAQUÉ NOIR - *BLACK LACQUERED*  
TOP EN GRANITE NOIR - *BLACK GRANITE TOP*

10180200



**2011 - LADY TINA GREEN & PIETRO MINGARELLI POUR LALIQUE**



CRISTAL INCOLORE - *CLEAR CRYSTAL*  
ÉBÈNE NATUREL - *NATURAL EBONY*  
TOP EN GRANITE NOIR - *BLACK GRANITE TOP*

73521040



**2019 - LADY TINA GREEN & PIETRO MINGARELLI POUR LALIQUE**



CRISTAL INCOLORE - *CLEAR CRYSTAL*  
FRÊNE IVOIRE - *IVORY ASH*  
TOP EN GRANITE NOIR - *BLACK GRANITE TOP*

10180211



**2013 - LADY TINA GREEN & PIETRO MINGARELLI POUR LALIQUE**



**MM / MS**



**GM / LS**

# CONSOLES - CONSOLES

## MASQUE DE FEMME

CIRCULAIRE / *CIRCULAR*

ÉDITION NUMÉROTÉE / *NUMBERED EDITION*



FINITION / *FINISHING*

REFERENCE

EAN CODE



CRISTAL INCOLORE - *CLEAR CRYSTAL*  
LAQUÉ NOIR - *BLACK LACQUERED*  
TOP EN GRANITE NOIR - *BLACK GRANITE TOP*

11180220



7 640111 506553

**2013 - LADY TINA GREEN & PIETRO MINGARELLI POUR LALIQUE**



CRISTAL INCOLORE - *CLEAR CRYSTAL*  
ÉBÈNE NATUREL - *NATURAL EBONY*  
TOP EN GRANITE NOIR - *BLACK GRANITE TOP*

73521000



7 640163 976236

**2015 - LADY TINA GREEN & PIETRO MINGARELLI POUR LALIQUE**

# CONSOLES - CONSOLES

RAISINS  
CIRCULAIRE / *CIRCULAR*  
ÉDITION NUMÉROTÉE / *NUMBERED EDITION*



45 kg / 99.21 pounds

FINITION / *FINISHING*

REFERENCE

EAN CODE



CRISTAL INCOLORE - *CLEAR CRYSTAL*  
LAQUÉ NOIR - *BLACK LACQUERED*  
TOP EN GRANITE NOIR - *BLACK GRANITE TOP*

73512000



7 640163 975901

2016 - LADY TINA GREEN & PIETRO MINGARELLI POUR LALIQUE



# CONSOLES - CONSOLES

## RAISINS

ÉDITION NUMÉROTÉE / *NUMBERED EDITION*



**RECTANGULAIRE / RECTANGULAR**



**CIRCULAIRE / CIRCULAR**

FINITION / *FINISHING*

REFERENCE

EAN CODE



CRISTAL INCOLORE - *CLEAR CRYSTAL*  
ÉBÈNE NATUREL - *NATURAL EBONY*  
TOP EN GRANITE NOIR - *BLACK GRANITE TOP*

73522000



CRISTAL INCOLORE - *CLEAR CRYSTAL*  
FRÈNE IVOIRE - *IVORY ASH*  
TOP EN GRANITE NOIR - *BLACK GRANITE TOP*

11180205



**2014 - LADY TINA GREEN & PIETRO MINGARELLI POUR LALIQUE**

**RECTANGULAIRE  
RECTANGULAR**



CRISTAL INCOLORE - *CLEAR CRYSTAL*  
LAQUÉ NOIR - *BLACK LACQUERED*  
TOP EN GRANITE NOIR - *BLACK GRANITE TOP*

73512040



**2018 - LADY TINA GREEN & PIETRO MINGARELLI POUR LALIQUE**



CRISTAL INCOLORE - *CLEAR CRYSTAL*  
LAQUÉ NOIR - *BLACK LACQUERED*  
TOP EN GRANITE NOIR - *BLACK GRANITE TOP*

73512600



**2017 - LADY TINA GREEN & PIETRO MINGARELLI POUR LALIQUE**

**CIRCULAIRE  
CIRCULAR**

# CONSOLES - CONSOLES

## ROSES

ÉDITION NUMÉROTÉE / *NUMBERED EDITION*

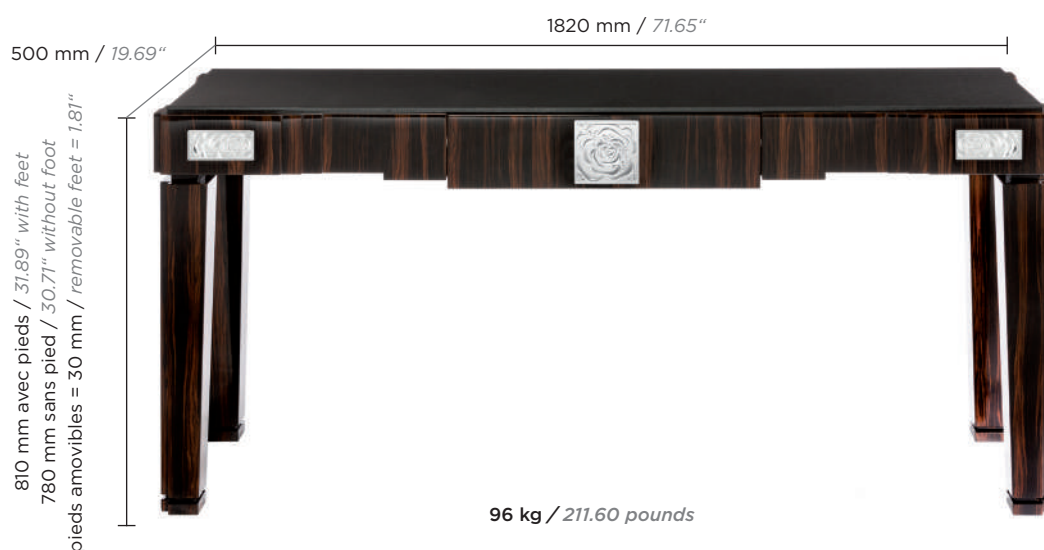

### FINITION / FINISHING

### REFERENCE

### EAN CODE



CRISTAL INCOLORE - *CLEAR CRYSTAL*  
ÉBÈNE NATUREL - *NATURAL EBONY*  
TOP EN GRANITE NOIR - *BLACK GRANITE TOP*

10180212



CRISTAL INCOLORE - *CLEAR CRYSTAL*  
BLEU EUCALYPTUS - *BLUE EUCALYPTUS*  
TOP EN GRANITE NOIR - *BLACK GRANITE TOP*

73550000



**2014 - LADY TINA GREEN & PIETRO MINGARELLI POUR LALIQUE**



CRISTAL INCOLORE - *CLEAR CRYSTAL*  
LAQUÉ NOIR - *BLACK LACQUERED*  
TOP EN GRANITE NOIR - *BLACK GRANITE TOP*

73519000



**2015 - LADY TINA GREEN & PIETRO MINGARELLI POUR LALIQUE**

# CRÉDENCES - *SIDEBOARDS*

## DRAGON

ÉDITION NUMÉROTÉE / *NUMBERED EDITION*



87 kg / 191.80 pounds

### FINITION / *FINISHING*

### REFERENCE

### EAN CODE



CRISTAL INCOLORE - *CLEAR CRYSTAL*  
FRÊNE IVOIRE - *IVORY ASH*

10179910



7 640111 506591



CRISTAL INCOLORE - *CLEAR CRYSTAL*  
LAQUÉ NOIR - *BLACK LACQUERED*

72419000



7 640163 972016

**2013 - LADY TINA GREEN & PIETRO MINGARELLI POUR LALIQUE**

# CRÉDENCES - *SIDEBOARDS*

## MASQUE DE FEMME

ÉDITION NUMÉROTÉE / *NUMBERED EDITION*

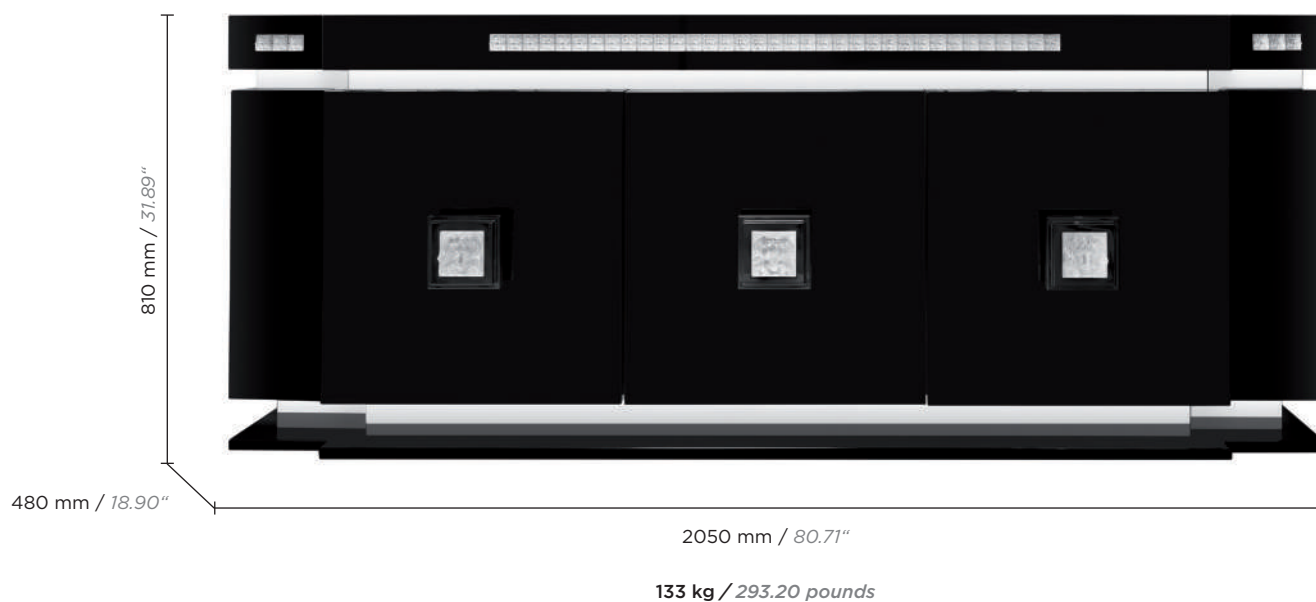

### FINITION / *FINISHING*

### REFERENCE

### EAN CODE

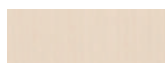

CRISTAL INCOLORE - *CLEAR CRYSTAL*  
FRÊNE IVOIRE - *IVORY ASH*

10180100



7 640111 493990



CRISTAL INCOLORE - *CLEAR CRYSTAL*  
LAQUÉ NOIR - *BLACK LACQUERED*

10180000



7 640111 493907

2011 - **LADY TINA GREEN & PIETRO MINGARELLI POUR LALIQUE**

# CRÉDENCES - *SIDEBOARDS*

## RAISINS

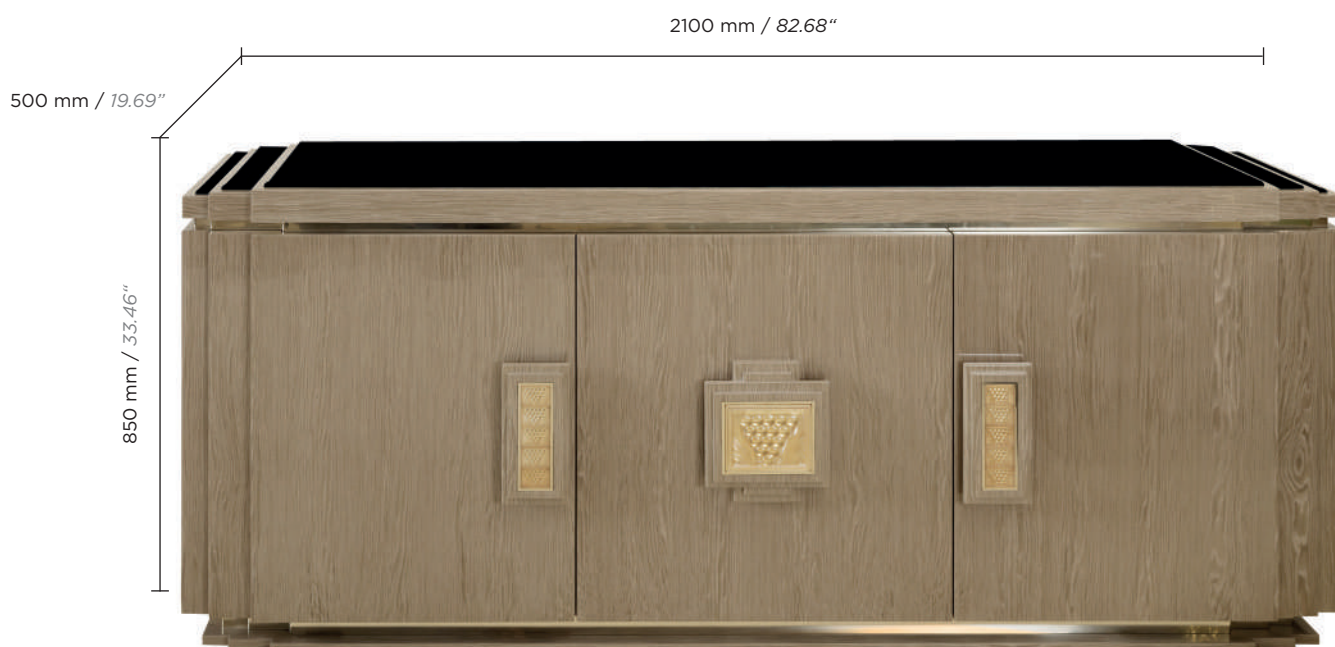

FINITION / FINISHING

REFERENCE

EAN CODE



CRISTAL LUSTRÉ OR - *GOLD LUSTER CRYSTAL*  
ACIER DORÉ SATINÉ - *INOX GOLDEN SATIN STEEL*  
BOIS NATUREL - *NATURAL WOOD*  
TOP EN GRANITE NOIR - *BLACK GRANITE TOP*

72492300



7 640182 870041

**2018 - LADY TINA GREEN & PIETRO MINGARELLI POUR LALIQUE**

# CRÉDENCES - *SIDEBOARDS*

RAISINS

ÉDITION NUMÉROTÉE / *NUMBERED EDITION*



Laqué noir / *Black lacquered*



Frêne ivoire / *Ivory ash*

FINITION / <i>FINISHING</i>	REFERENCE	EAN CODE
<b>L1800 x 1480 x H810 mm</b> <b>L70.87" x W18.90"</b> <b>x H31.89"</b>	 CRISTAL INCOLORE - <i>CLEAR CRYSTAL</i> LAQUÉ NOIR - <i>BLACK LACQUERED</i> ACIER POLI - <i>POLISHED STEEL</i>	72412100  7 640163 975895
<b>2015 - LADY TINA GREEN &amp; PIETRO MINGARELLI POUR LALIQUE</b>		
 CRISTAL INCOLORE - <i>CLEAR CRYSTAL</i> FRÊNE IVOIRE - <i>IVORY ASH</i> ACIER POLI - <i>POLISHED STEEL</i>	10179900	 7 640111 494034
 CRISTAL INCOLORE - <i>CLEAR CRYSTAL</i> LAQUÉ NOIR - <i>BLACK LACQUERED</i> ACIER POLI - <i>POLISHED STEEL</i>	10179800	 7 640111 494010
<b>2011 - LADY TINA GREEN &amp; PIETRO MINGARELLI POUR LALIQUE</b>		
 CRISTAL INCOLORE - <i>CLEAR CRYSTAL</i> ÉBÈNE NATUREL - <i>NATURAL EBONY</i> ACIER DORÉ SATINÉ - <i>INOX GOLDEN SATIN STEEL</i>	72422002	 7 640163 974614
 CRISTAL INCOLORE - <i>CLEAR CRYSTAL</i> FRÊNE IVOIRE - <i>IVORY ASH</i> ACIER DORÉ SATINÉ - <i>INOX GOLDEN SATIN STEEL</i>	72442004	 7 640163 975253
<b>2015 - LADY TINA GREEN &amp; PIETRO MINGARELLI POUR LALIQUE</b>		
 CRISTAL INCOLORE - <i>CLEAR CRYSTAL</i> ÉBÈNE NATUREL - <i>NATURAL EBONY</i> ACIER DORÉ - <i>INOX GOLDEN SATIN STEEL</i>	72422006	 7 640163 975994
<b>2018 - LADY TINA GREEN &amp; PIETRO MINGARELLI POUR LALIQUE</b>		

# TABLES - TABLES

## RAISINS

ÉDITION NUMÉROTÉE / NUMBERED EDITION



FINITION / FINISHING

REFERENCE

EAN CODE



**8 PERSONNES MAXIMUM - 8 PERSONS MAXIMUM**  
 CRISTAL INCOLORE - CLEAR CRYSTAL  
 LAQUÉ NOIR - BLACK LACQUERED

10293601



**10 PERSONNES MAXIMUM - 10 PERSONS MAXIMUM**  
 CRISTAL INCOLORE - CLEAR CRYSTAL  
 LAQUÉ NOIR - BLACK LACQUERED

10293600



2012 - LADY TINA GREEN & PIETRO MINGARELLI POUR LALIQUE

# TABLES - TABLES

RAISINS  
CARRÉ / SQUARE  
RONDE / ROUND



FINITION / FINISHING

REFERENCE

EAN CODE



CARRÉ / SQUARE



**6 PERSONNES MAXIMUM - 6 PERSONS MAXIMUM**  
CRISTAL INCOLORE - CLEAR CRYSTAL  
LAQUÉ NOIR - BLACK LACQUERED

73112710



7 640163 973631



RONDE / ROUND



**6 PERSONNES MAXIMUM - 6 PERSONS MAXIMUM**  
CRISTAL INCOLORE - CLEAR CRYSTAL  
LAQUÉ NOIR - BLACK LACQUERED

73112410



7 640163 973594

2017 - LADY TINA GREEN & PIETRO MINGARELLI POUR LALIQUE



# TABLES D'APPOINT - *SIDE TABLES*

## MASQUE DE FEMME

ÉDITION NUMÉROTÉE / *NUMBERED EDITION*

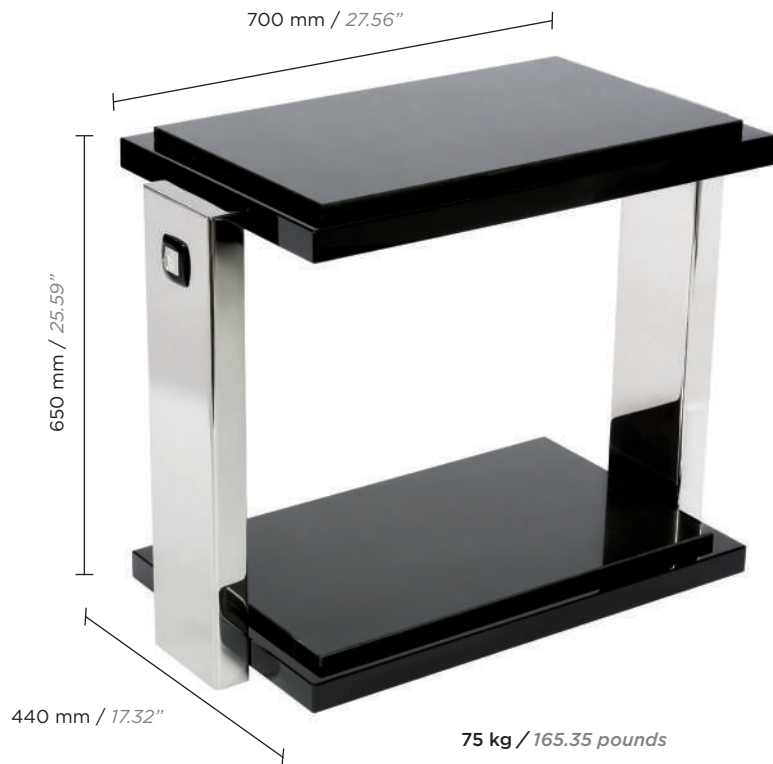

75 kg / 165.35 pounds

Laqué noir / *Black lacquered*



Ébène naturel / *Natural ebony*

### FINITION / *FINISHING*

### REFERENCE

### EAN CODE



CRISTAL INCOLORE - *CLEAR CRYSTAL*  
ACIER POLI - *POLISHED STEEL*  
LAQUÉ NOIR - *BLACK LACQUERED*  
TOP EN GRANITE NOIR - *BLACK GRANITE TOP*

10190030



**2013 - LADY TINA GREEN & PIETRO MINGARELLI POUR LALIQUE**



CRISTAL INCOLORE - *CLEAR CRYSTAL*  
ACIER POLI - *POLISHED STEEL*  
ÉBÈNE NATUREL - *NATURAL EBONY*  
TOP EN GRANITE NOIR - *BLACK GRANITE TOP*

10190040



**2014 - LADY TINA GREEN & PIETRO MINGARELLI POUR LALIQUE**



CRISTAL INCOLORE - *CLEAR CRYSTAL*  
ACIER POLI - *POLISHED STEEL*  
ÉBÈNE NOIR - *BLACK EBONY*  
TOP EN GRANITE NOIR - *BLACK GRANITE TOP*

73331000



**2018 - LADY TINA GREEN & PIETRO MINGARELLI POUR LALIQUE**



CRISTAL INCOLORE - *CLEAR CRYSTAL*  
ACIER POLI - *POLISHED STEEL*  
FRÈNE IVOIRE - *IVORY ASH*  
TOP EN GRANITE NOIR - *BLACK GRANITE TOP*

73341000



**2018 - LADY TINA GREEN & PIETRO MINGARELLI POUR LALIQUE**

# TABLES D'APPOINT - SIDE TABLES

RAISINS

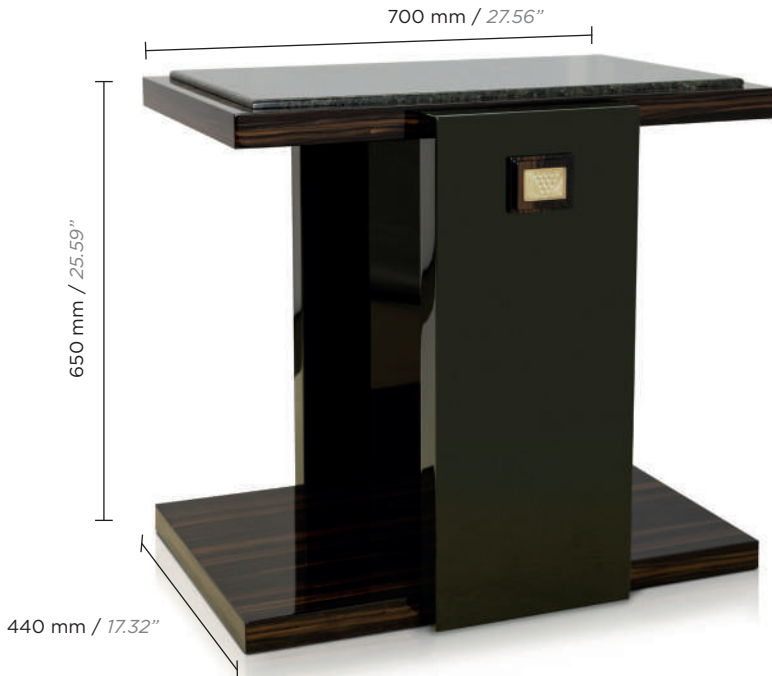

75 kg / 165.35 pounds

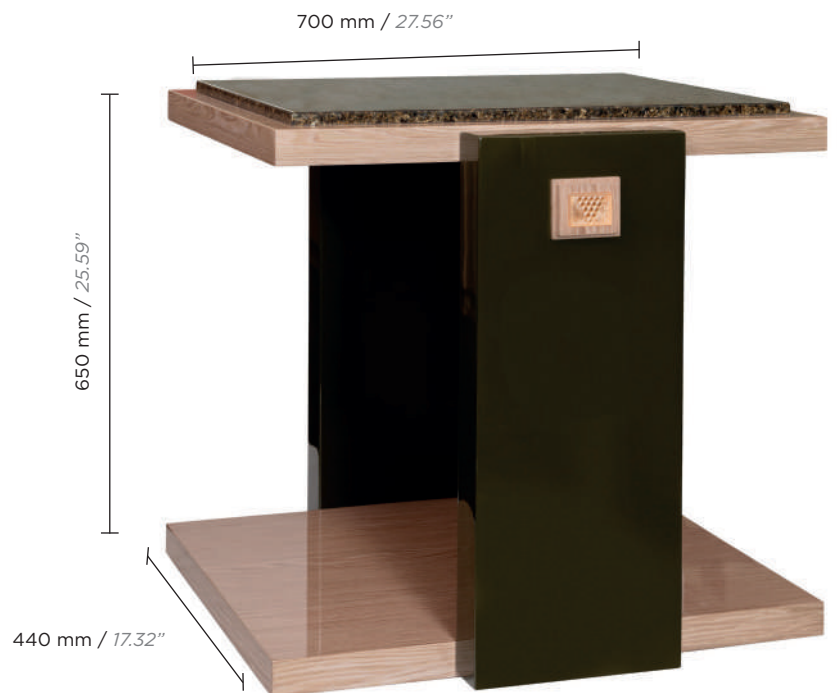

75 kg / 165.35 pounds

FINITION / FINISHING

REFERENCE

EAN CODE



CRISTAL LUSTRÉ OR - GOLD LUSTER CRYSTAL  
EBÈNE NATUREL - NATURAL EBONY  
LAQUÉ VERT - GREEN LACQUERED

73362040



2018 - LADY TINA GREEN & PIETRO MINGARELLI POUR LALIQUE



CRISTAL LUSTRÉ OR - GOLD LUSTER CRYSTAL  
BOIS NATUREL - NATURAL WOOD  
LAQUÉ VERT - GREEN LACQUERED

73362050



2019 - LADY TINA GREEN & PIETRO MINGARELLI POUR LALIQUE

# TABLES D'APPOINT - SIDE TABLES

## RAISINS

ÉDITION NUMÉROTÉE / NUMBERED EDITION



23 kg / 50.71 pounds

Ovale / Ovale



800 mm / 31.50"

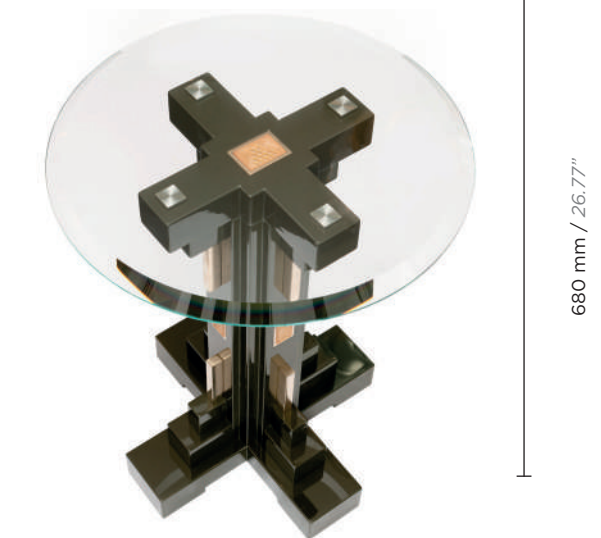

37 kg / 81.58 pounds

Rond / Circulare

FINITION / FINISHING

REFERENCE

EAN CODE

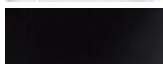

**OVALE / OVALE**

CRISTAL INCOLORE - CLEAR CRYSTAL  
LAQUÉ NOIR - BLACK LACQUERED  
TOP EN VERRE - GLASS TOP

73312510



**ROND / CIRCULARE**

CRISTAL INCOLORE - CLEAR CRYSTAL  
LAQUÉ NOIR - BLACK LACQUERED  
TOP EN VERRE - GLASS TOP

73312410



2016 - LADY TINA GREEN & PIETRO MINGARELLI POUR LALIQUE

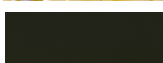

**ROND / CIRCULARE**

CRISTAL LUSTRÉ OR - GOLD LUSTER CRYSTAL  
LAQUÉ VERT - GREEN LACQUERED  
TOP EN VERRE - GLASS TOP

73382410



2019 - LADY TINA GREEN & PIETRO MINGARELLI POUR LALIQUE

# TABLES BASSES - COFFEE TABLES

## MASQUE DE FEMME

ÉDITION NUMÉROTÉE / NUMBERED EDITION

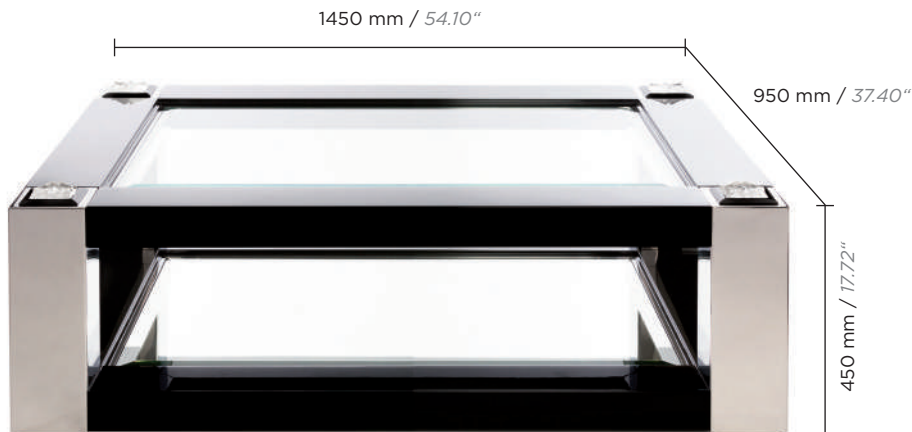

**PM / SS**

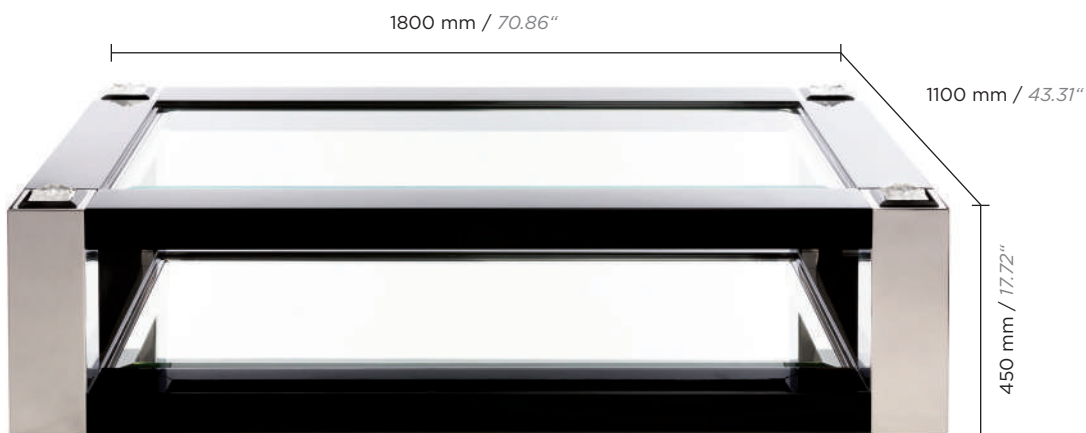

**GM / LS**

195 kg / 430 pounds

### FINITION / FINISHING

### REFERENCE

### EAN CODE



**PM / SS**



CRISTAL INCOLORE - CLEAR CRYSTAL  
LAQUÉ NOIR - BLACK LACQUERED  
ACIER POLI - POLISHED STEEL

73211100



7 640111 509424

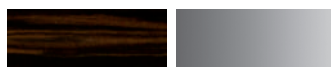

CRISTAL INCOLORE - CLEAR CRYSTAL  
ÉBÈNE NATUREL - NATURAL EBONY  
ACIER POLI - POLISHED STEEL

73221100



7 640111 509394

**2014 - LADY TINA GREEN & PIETRO MINGARELLI POUR LALIQUE**



**GM / LS**



CRISTAL INCOLORE - CLEAR CRYSTAL  
LAQUÉ NOIR - BLACK LACQUERED  
ACIER POLI - POLISHED STEEL

10293610



7 640111 506584



CRISTAL INCOLORE - CLEAR CRYSTAL  
ÉBÈNE NATUREL - NATURAL EBONY  
ACIER POLI - POLISHED STEEL

73221000



7 640111 509400

**2014 - LADY TINA GREEN & PIETRO MINGARELLI POUR LALIQUE**



CRISTAL INCOLORE - CLEAR CRYSTAL  
LAQUÉ NOIR - BLACK LACQUERED  
ÉBÈNE NATUREL - NATURAL EBONY

73211000



7 640163 974577

**2015 - LADY TINA GREEN & PIETRO MINGARELLI POUR LALIQUE**

# TABLES BASSES - COFFEE TABLES

## RAISINS



FINITION / FINISHING

REFERENCE

EAN CODE



CRISTAL LUSTRÉ OR - *GOLD LUSTER CRYSTAL*  
 EBÈNE NATUREL - *NATURAL EBONY*  
 LAQUÉ VERT - *GREEN LACQUERED*

73262130



**2018 - LADY TINA GREEN & PIETRO MINGARELLI POUR LALIQUE**



CRISTAL LUSTRÉ OR - *GOLD LUSTER CRYSTAL*  
 BOIS NATUREL - *NATURAL WOOD*  
 LAQUÉ VERT - *GREEN LACQUERED*

73222130



**2019 - LADY TINA GREEN & PIETRO MINGARELLI POUR LALIQUE**

# TABLES BASSES - COFFEE TABLES

RAISINS

ÉDITION NUMÉROTÉE / NUMBERED EDITION

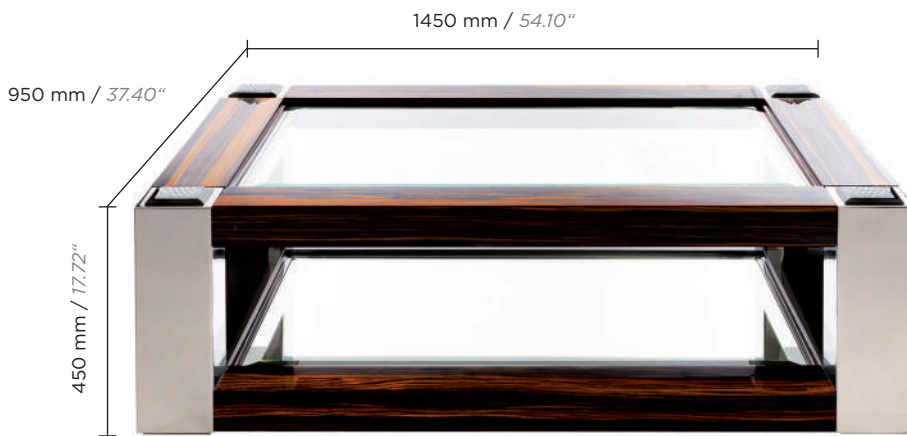

**PM / SS**

Ébène naturel - acier poli / Natural ebony - polished steel



**GM / LS**

Photos non contractuelles / Non contractual pictures

Laqué noir - ébène naturel / Black lacquered - natural ebony

FINITION / FINISHING

REFERENCE

EAN CODE



**PM / SS**



CRISTAL INCOLORE - CLEAR CRYSTAL  
ÉBÈNE NATUREL - NATURAL EBONY  
ACIER POLI - POLISHED STEEL

73222100



7 640163 975741



**GM / LS**

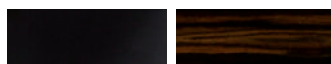

CRISTAL INCOLORE - CLEAR CRYSTAL  
LAQUÉ NOIR - BLACK LACQUERED  
ÉBÈNE NATUREL - NATURAL EBONY

73212000



7 640163 974584



CRISTAL INCOLORE - CLEAR CRYSTAL  
LAQUÉ NOIR - BLACK LACQUERED  
ACIER POLI - POLISHED STEEL

73212005



7 640182 872212

2015 / 2019 - LADY TINA GREEN & PIETRO MINGARELLI POUR LALIQUE

# TABLES BASSES - COFFEE TABLES

## RAISINS

ÉDITION NUMÉROTÉE / *NUMBERED EDITION*



FINITION / *FINISHING*

REFERENCE

EAN CODE



**PM / SS**



CRISTAL INCOLORE - *CLEAR CRYSTAL*  
LAQUÉ NOIR - *BLACK LACQUERED*

73212630



**GM / LS**



CRISTAL INCOLORE - *CLEAR CRYSTAL*  
LAQUÉ NOIR - *BLACK LACQUERED*

73212610



2017 - LADY TINA GREEN & PIETRO MINGARELLI POUR LALIQUE

# TABLES DE CHEVET - *BEDSIDE TABLES*

## MASQUE DE FEMME

ÉDITION NUMÉROTÉE / *NUMBERED EDITION*

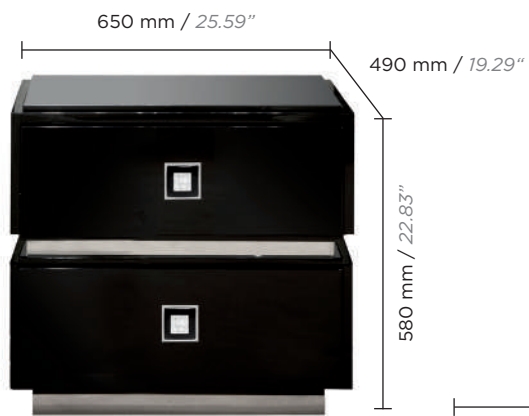

**PM / SS**

Laqué noir / *Black lacquered*

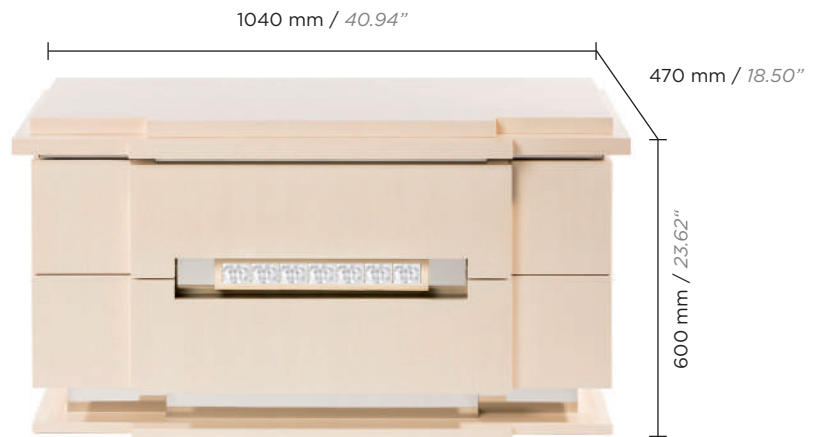

**17 kg / 37.5 pounds**

**GM / LS**

Frêne ivoire / *Ivory ash*

### FINITION / *FINISHING*

### REFERENCE

### EAN CODE



CRISTAL INCOLORE - *CLEAR CRYSTAL*  
LAQUÉ NOIR - *BLACK LACQUERED*  
TOP EN GRANITE NOIR - *BLACK GRANITE TOP*

10185105



7 640111 508342



CRISTAL INCOLORE - *CLEAR CRYSTAL*  
ÉBÈNE NATUREL - *NATURAL EBONY*  
TOP EN GRANITE NOIR - *BLACK GRANITE TOP*

74221100



7 640111 509295

**2014 - LADY TINA GREEN & PIETRO MINGARELLI POUR LALIQUE**

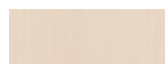

CRISTAL INCOLORE - *CLEAR CRYSTAL*  
FRÊNE IVOIRE - *IVORY ASH*  
TOP EN GRANITE NOIR - *BLACK GRANITE TOP*

74241100



7 640163 975260

**2015 - LADY TINA GREEN & PIETRO MINGARELLI POUR LALIQUE**



**PM / SS**



CRISTAL INCOLORE - *CLEAR CRYSTAL*  
BLEU EUCALYPTUS - *BLUE EUCALYPTUS*  
TOP EN GRANITE NOIR - *BLACK GRANITE TOP*

74251100



7 640163 973136

**2018 - LADY TINA GREEN & PIETRO MINGARELLI POUR LALIQUE**



CRISTAL INCOLORE - *CLEAR CRYSTAL*  
LAQUÉ NOIR - *BLACK LACQUERED*

10185100



7 640111 494393

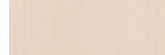

CRISTAL INCOLORE - *CLEAR CRYSTAL*  
FRÊNE IVOIRE - *IVORY ASH*

10185200



7 640111 494409

**2011 - LADY TINA GREEN & PIETRO MINGARELLI POUR LALIQUE**



**GM / LS**



CRISTAL INCOLORE - *CLEAR CRYSTAL*  
BLEU EUCALYPTUS - *BLUE EUCALYPTUS*

74251610



7 640182 871482

**2018 - LADY TINA GREEN & PIETRO MINGARELLI POUR LALIQUE**



# TABLES DE CHEVET - *BEDSIDE TABLES*

## RAISINS

ÉDITION NUMÉROTÉE / *NUMBERED EDITION*

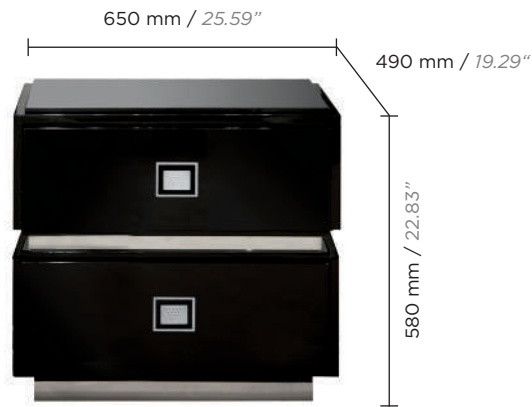

**PM / SS**

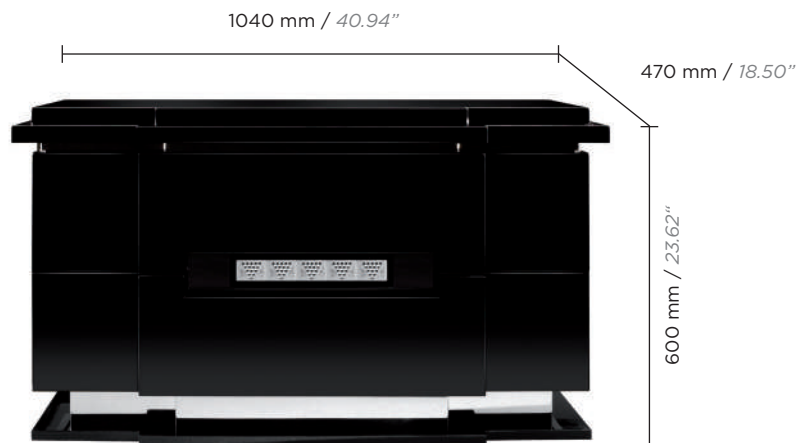

**GM / LS**

17 kg / 37.5 pounds

FINITION / *FINISHING*

REFERENCE

EAN CODE



**PM / SS**



CRISTAL INCOLORE - *CLEAR CRYSTAL*  
LAQUÉ NOIR - *BLACK LACQUERED*  
TOP EN GRANITE NOIR - *BLACK GRANITE TOP*

**2014 - LADY TINA GREEN & PIETRO MINGARELLI POUR LALIQUE**

10184905



7 640111 508335



CRISTAL INCOLORE - *CLEAR CRYSTAL*  
FRÈNE IVOIRE - *IVORY ASH*  
TOP EN GRANITE NOIR - *BLACK GRANITE TOP*

**2015 - LADY TINA GREEN & PIETRO MINGARELLI POUR LALIQUE**

74242100



7 640163 976083



CRISTAL INCOLORE - *CLEAR CRYSTAL*  
BLEU EUCALYPTUS - *BLUE EUCALYPTUS*  
TOP EN GRANITE NOIR - *BLACK GRANITE TOP*

74252410



7 640182 871383



**GM / LS**



CRISTAL INCOLORE - *CLEAR CRYSTAL*  
LAQUÉ NOIR - *BLACK LACQUERED*

10184900



7 640111 494294



CRISTAL INCOLORE - *CLEAR CRYSTAL*  
FRÈNE IVOIRE - *IVORY ASH*

10185000



7 640111 494386

**2011 - LADY TINA GREEN & PIETRO MINGARELLI POUR LALIQUE**

# TABLES DE CHEVET - *BEDSIDE TABLES*

RAISINS



**PM / SS**



**GM / LS**

FINITION / FINISHING

REFERENCE

EAN CODE



**PM / SS**



CRISTAL LUSTRÉ OR - *GOLD LUSTER CRYSTAL*  
BOIS NATUREL - *NATURAL WOOD*

74262410



7 640182 870027



**GM / LS**



CRISTAL LUSTRÉ OR - *GOLD LUSTER CRYSTAL*  
BOIS NATUREL - *NATURAL WOOD*

74262510



7 640182 870010

2018 - LADY TINA GREEN & PIETRO MINGARELLI POUR LALIQUE

# TABLES GIGOGNES - SIDE TABLES (NESTING TABLES)

## MASQUE DE FEMME

ÉDITION NUMÉROTÉE / NUMBERED EDITION

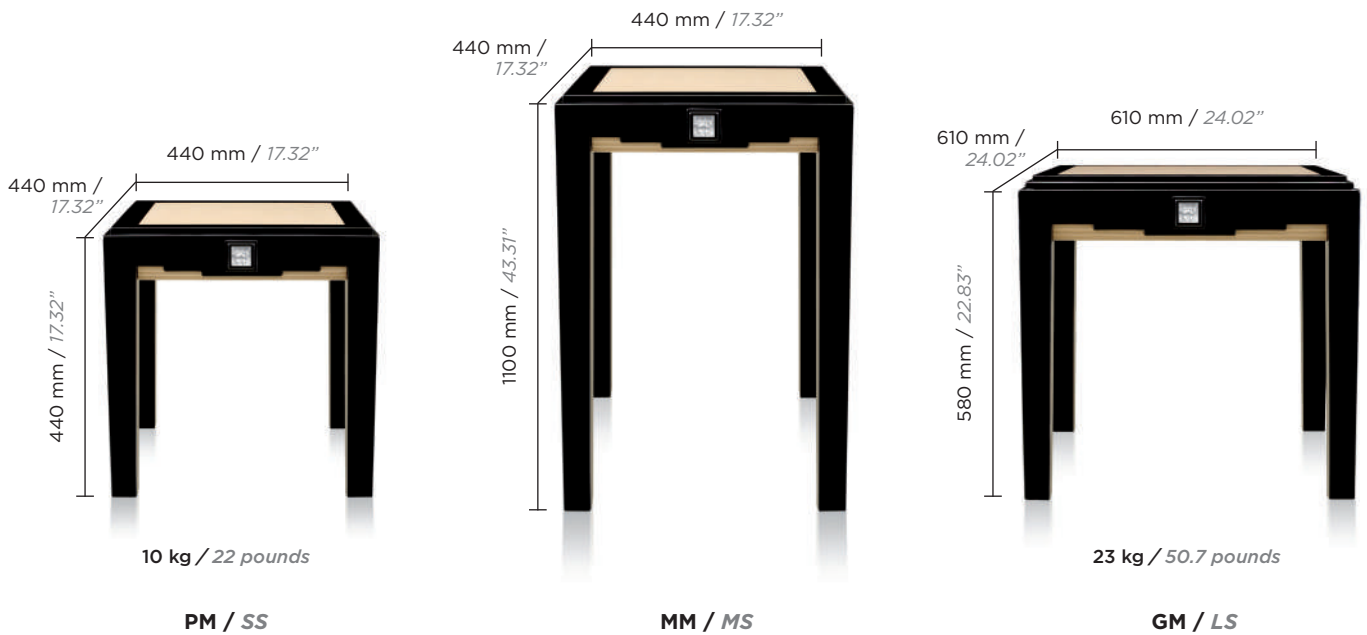

FINITION / FINISHING	REFERENCE	EAN CODE
 <b>PM / SS</b>  CRISTAL INCOLORE - CLEAR CRYSTAL LAQUÉ NOIR - BLACK LACQUERED FRÊNE IVOIRE - IVORY ASH <b>2012 - LADY TINA GREEN &amp; PIETRO MINGARELLI POUR LALIQUE</b>	10180600	 7 640111 493877
 <b>MM / MS</b>  CRISTAL INCOLORE - CLEAR CRYSTAL LAQUÉ NOIR - BLACK LACQUERED FRÊNE IVOIRE - IVORY ASH <b>2015 - LADY TINA GREEN &amp; PIETRO MINGARELLI POUR LALIQUE</b>	73311300	 7 640111 509448
 <b>GM / LS</b>  CRISTAL INCOLORE - CLEAR CRYSTAL LAQUÉ NOIR - BLACK LACQUERED FRÊNE IVOIRE - IVORY ASH <b>2012 - LADY TINA GREEN &amp; PIETRO MINGARELLI POUR LALIQUE</b>	10180500	 7 640111 493860

# TABLES GIGOGNES - SIDE TABLES (NESTING TABLES)

RAISINS

ÉDITION NUMÉROTÉE / NUMBERED EDITION

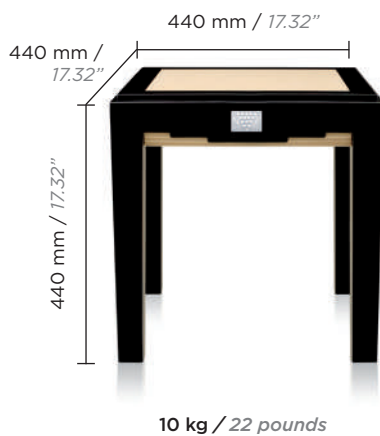

10 kg / 22 pounds

PM / SS

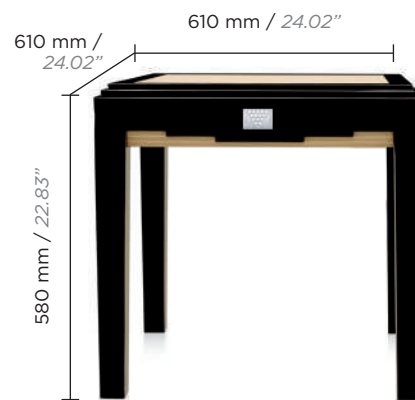

23 kg / 50.7 pounds

GM / LS

FINITION / FINISHING

REFERENCE

EAN CODE



PM / SS



CRISTAL INCOLORE - CLEAR CRYSTAL  
LAQUÉ NOIR - BLACK LACQUERED  
FRÈNE IVOIRE - IVORY ASH

10180400



7 640111 493891



GM / LS



CRISTAL INCOLORE - CLEAR CRYSTAL  
LAQUÉ NOIR - BLACK LACQUERED  
FRÈNE IVOIRE - IVORY ASH

10180300



7 640111 493884

2012 - LADY TINA GREEN & PIETRO MINGARELLI POUR LALIQUE

# VITRINE - DISPLAY UNIT

## DAHLIA

ÉDITION NUMÉROTÉE / *NUMBERED EDITION*



182 kg / 420.24 pounds

FINITION / *FINISHING*

REFERENCE

EAN CODE



CRISTAL INCOLORE - *CLEAR CRYSTAL*  
LAQUÉ NOIR - *BLACK LACQUERED*  
2 PORTES - *2 DOORS*

72618310



7 640163 972085

2016 - LADY TINA GREEN & PIETRO MINGARELLI POUR LALIQUE

# VITRINE - DISPLAY UNIT

RAISINS

ÉDITION NUMÉROTÉE / *NUMBERED EDITION*



2020 mm / 79.53"

440 mm / 17.32"

1020 mm / 40.16"

182 kg / 420.24 pounds

FINITION / *FINISHING*

REFERENCE

EAN CODE



CRISTAL LUSTRÉ OR - *GOLD LUSTER CRYSTAL*  
CHÊNE SPÉCIAL - *SPECIAL OAK*  
2 PORTES - *2 DOORS*

72692310



2019 - LADY TINA GREEN & PIETRO MINGARELLI POUR LALIQUE



ASSISES - SEATINGS





# CANAPÉS CLASSIQUES - CLASSIC SOFAS

## RAISINS



2200 mm / 86.61"

**PM / SS**

97 kg / 214 pounds



2600 mm / 102.36"

**MM / MS**

107 kg / 236 pounds





















3000 mm / 118.11"

**GM / LS**

# CANAPÉS CLASSIQUES - CLASSIC SOFAS

RAISINS



FINITION / FINISHING		REFERENCE	EAN CODE
 <b>PM / SS</b>	 CRISTAL INCOLORE - <i>CLEAR CRYSTAL</i> SOIE IVOIRE - <i>IVORY SILK</i>	11293302	 7 640111 496366
	 CRISTAL INCOLORE - <i>CLEAR CRYSTAL</i> SOIE NOIRE - <i>BLACK SILK</i>	11293305	 7 640111 500155
	<b>2012 - LADY TINA GREEN &amp; PIETRO MINGARELLI POUR LALIQUE</b>		
	 CRISTAL INCOLORE - <i>CLEAR CRYSTAL</i> CUIR IVOIRE - <i>IVORY LEATHER</i>	71102163	 7 640163 976090
 <b>MM / MS</b>	 CRISTAL INCOLORE - <i>CLEAR CRYSTAL</i> SOIE IVOIRE - <i>IVORY SILK</i>	11293301	 7 640111 500254
	 CRISTAL INCOLORE - <i>CLEAR CRYSTAL</i> SOIE NOIRE - <i>BLACK SILK</i>	11293304	 7 640111 500148
	<b>2012 - LADY TINA GREEN &amp; PIETRO MINGARELLI POUR LALIQUE</b>		
	 CRISTAL INCOLORE - <i>CLEAR CRYSTAL</i> CHENILLE CRÈME - <i>CHENILLE HEAVY CREAM</i>	11293307	 7 640111 506881
 <b>GM / LS</b>	 CRISTAL INCOLORE - <i>CLEAR CRYSTAL</i> SOIE IVOIRE - <i>IVORY SILK</i>	11293300	 7 640111 496342
	 CRISTAL INCOLORE - <i>CLEAR CRYSTAL</i> SOIE NOIRE - <i>BLACK SILK</i>	11293303	 7 640111 500131
	<b>2012 - LADY TINA GREEN &amp; PIETRO MINGARELLI POUR LALIQUE</b>		
	Autres couleurs et tissus disponibles sur demande. / Others colours and fabrics available on request.		

# CANAPÉS CONTEMPORAINS - *CONTEMPORARY SOFAS*

## MASQUE DE FEMME



**PM / SS**

*Soie noire / Black silk*



**PM / SS**

**97 kg / 213.40 pounds**

*Chenille ivoire / Chenille ivory*

## MASQUE DE FEMME



FINITION / FINISHING

REFERENCE

EAN CODE

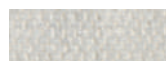

CRISTAL INCOLORE - *CLEAR CRYSTAL*  
CHENILLE IVOIRE - *CHENILLE IVORY*

10293910



**2014 - LADY TINA GREEN & PIETRO MINGARELLI POUR LALIQUE**



CRISTAL INCOLORE - *CLEAR CRYSTAL*  
SOIE IVOIRE - *IVORY SILK*

10293900



CRISTAL INCOLORE - *CLEAR CRYSTAL*  
SOIE NOIRE - *BLACK SILK*

10293901



**2012 - LADY TINA GREEN & PIETRO MINGARELLI POUR LALIQUE**



PM / SS



CRISTAL INCOLORE - *CLEAR CRYSTAL*  
SOIE INDIGO - *INDIGO SILK*

10293902

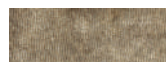

CRISTAL INCOLORE - *CLEAR CRYSTAL*  
VELOURS CLASSIQUE, COULEUR LIN  
*CLASSIC VELVET LINEN*

71101121

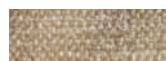

CRISTAL INCOLORE - *CLEAR CRYSTAL*  
CHENILLE CRÈME - *CHENILLE HEAVY CREAM*

71101112

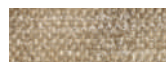

CRISTAL INCOLORE - *CLEAR CRYSTAL*  
CHENILLE CRÈME, CAPITONNÉ  
*CHENILLE HEAVY CREAM, DEEP QUILT*

71101012



**2015 - LADY TINA GREEN & PIETRO MINGARELLI POUR LALIQUE**



CRISTAL INCOLORE - *CLEAR CRYSTAL*  
VELOURS CLASSIQUE, COULEUR ÉBÈNE  
*CLASSIC VELVET, EBONY*

71111123



**2017 - LADY TINA GREEN & PIETRO MINGARELLI POUR LALIQUE**



CRISTAL INCOLORE - *CLEAR CRYSTAL*  
CHENILLE MEDLEY - *CHENILLE MEDLEY*

71101124



**2018 - LADY TINA GREEN & PIETRO MINGARELLI POUR LALIQUE**

Autres couleurs et tissus disponibles sur demande. / Others colours and fabrics available on request.

# CANAPÉS CONTEMPORAINS - *CONTEMPORARY SOFAS*

## MASQUE DE FEMME



2600 mm / 102.36"

**MM / MS**

170 kg / 374 pounds

Chenille ivoire / *Chenille ivory*



3000 mm / 118.11"

**GM / LS**

Soie noire / *Black silk*

# CANAPÉS CONTEMPORAINS - CONTEMPORARY SOFAS

## MASQUE DE FEMME



FINITION / FINISHING

REFERENCE

EAN CODE



CRISTAL INCOLORE - *CLEAR CRYSTAL*  
SOIE IVOIRE - *IVORY SILK*

10294000



CRISTAL INCOLORE - *CLEAR CRYSTAL*  
SOIE NOIRE - *BLACK SILK*

10294001



**2012 - LADY TINA GREEN & PIETRO MINGARELLI POUR LALIQUE**



CRISTAL INCOLORE - *CLEAR CRYSTAL*  
VELOURS CLASSIQUE, COULEUR LIN  
*CLASSIC VELVET LINEN*

71101221



CRISTAL INCOLORE - *CLEAR CRYSTAL*  
VELOURS CLASSIQUE, COULEUR ÉBÈNE  
*CLASSIC VELVET, EBONY*

71101223

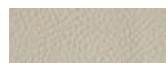

CRISTAL INCOLORE - *CLEAR CRYSTAL*  
CUIR IVOIRE - *IVORY LEATHER*

71101263



CRISTAL INCOLORE - *CLEAR CRYSTAL*  
CUIR IMPRIMÉ CROCO IVOIRE  
*LEATHER PRINTED IVORY CROCO*

71101264



**2015 - LADY TINA GREEN & PIETRO MINGARELLI POUR LALIQUE**



MM / MS



CRISTAL INCOLORE - *CLEAR CRYSTAL*  
SOIE IVOIRE - *IVORY SILK*

10294100



CRISTAL INCOLORE - *CLEAR CRYSTAL*  
SOIE NOIRE - *BLACK SILK*

10294101



**2012 - LADY TINA GREEN & PIETRO MINGARELLI POUR LALIQUE**



GM / LS

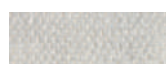

CRISTAL INCOLORE - *CLEAR CRYSTAL*  
CHENILLE IVOIRE - *CHENILLE IVORY*

71101011



**2014 - LADY TINA GREEN & PIETRO MINGARELLI POUR LALIQUE**



CRISTAL INCOLORE - *CLEAR CRYSTAL*  
VELOURS CLASSIQUE, COULEUR ÉBÈNE  
*CLASSIC VELVET, EBONY*

71101319



**2018 - LADY TINA GREEN & PIETRO MINGARELLI POUR LALIQUE**

Autres couleurs et tissus disponibles sur demande. / Others colours and fabrics available on request.

# CANAPÉS CONTEMPORAINS - *CONTEMPORARY SOFAS*

## RAISINS



2200 mm / 86.61"

**PM / SS**

97 kg / 213.40 pounds

FINITION / FINISHING

REFERENCE

EAN CODE



CRISTAL LUSTRÉ OR - *GOLD LUSTER CRYSTAL*  
VELOURS VERT - *GREEN VELVET*

71102226



**2018 - LADY TINA GREEN & PIETRO MINGARELLI POUR LALIQUE**

Autres couleurs et tissus disponibles sur demande. / *Others colours and fabrics available on request.*

# CHAISES CONTEMPORAINES - CONTEMPORARY CHAIRS

## MASQUE DE FEMME AVEC ACCOUDOIRS / WITH ARMRESTS



660 mm / 25.98"













620 mm / 24.41"

980 mm / 38.58"

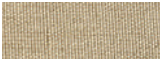

13 kg / 28.70 pounds

Soie ivoire / Ivory silk

FINITION / FINISHING	REFERENCE	EAN CODE
  CRISTAL INCOLORE - CLEAR CRYSTAL LAQUÉ NOIR - BLACK LACQUERED SOIE IVOIRE - IVORY SILK <b>2012 - LADY TINA GREEN &amp; PIETRO MINGARELLI POUR LALIQUE</b>	10294500	 7 640111 496304
  CRISTAL INCOLORE - CLEAR CRYSTAL LAQUÉ NOIR - BLACK LACQUERED SOIE NOIRE - BLACK SILK	71311516	 7 640111 509172
  CRISTAL INCOLORE - CLEAR CRYSTAL LAQUÉ NOIR - BLACK LACQUERED CUIR IMPRIMÉ CROCO NOIR - LEATHER PRINTED BLACK CROCO <b>2014 - LADY TINA GREEN &amp; PIETRO MINGARELLI POUR LALIQUE</b>	11294550	 7 640111 508694
  CRISTAL INCOLORE - CLEAR CRYSTAL LAQUÉ NOIR - BLACK LACQUERED CUIR IMPRIMÉ CROCO NOIR, CAPITONNÉ LEATHER PRINTED BLACK CROCO, DEEP QUILT	71311562	 7 640163 976137
  CRISTAL INCOLORE - CLEAR CRYSTAL LAQUÉ NOIR - BLACK LACQUERED SOIE CRÈME, CAPITONNÉ - HEAVY CREAM SILK, DEEP QUILT <b>2015 - LADY TINA GREEN &amp; PIETRO MINGARELLI POUR LALIQUE</b>	71311530	 7 640163 976175

Autres couleurs et tissus disponibles sur demande. / Others colours and fabrics available on request.



# CHAISES CONTEMPORAINES - CONTEMPORARY CHAIRS

## MASQUE DE FEMME

SANS ACCOUDOIR / *WITHOUT ARMREST*



Soie ivoire / *Ivory silk*

### FINITION / FINISHING

### REFERENCE

### EAN CODE

		CRISTAL INCOLORE - <i>CLEAR CRYSTAL</i> LAQUÉ NOIR - <i>BLACK LACQUERED</i> SOIE IVOIRE - <i>IVORY SILK</i>	10294400	 7 640111 496298
<b>2012 - LADY TINA GREEN &amp; PIETRO MINGARELLI POUR LALIQUE</b>				
		CRISTAL INCOLORE - <i>CLEAR CRYSTAL</i> LAQUÉ NOIR - <i>BLACK LACQUERED</i> SOIE INDIGO - <i>INDIGO SILK</i>	10294402	 7 640111 508687
		CRISTAL INCOLORE - <i>CLEAR CRYSTAL</i> LAQUÉ NOIR - <i>BLACK LACQUERED</i> SOIE CRÈME - <i>HEAVY CREAM SILK</i>	71311715	 7 640111 509189
		CRISTAL INCOLORE - <i>CLEAR CRYSTAL</i> LAQUÉ NOIR - <i>BLACK LACQUERED</i> CUIR IMPRIMÉ CROCO NOIR - <i>LEATHER PRINTED BLACK CROCO</i>	71311762	 7 640163 975314
		CRISTAL INCOLORE - <i>CLEAR CRYSTAL</i> LAQUÉ NOIR - <i>BLACK LACQUERED</i> SOIE CRÈME, CAPITONNÉ - <i>HEAVY CREAM SILK, DEEP QUILT</i>	71311730	 7 640163 976182
<b>2015 - LADY TINA GREEN &amp; PIETRO MINGARELLI POUR LALIQUE</b>				
		CRISTAL INCOLORE - <i>CLEAR CRYSTAL</i> LAQUÉ NOIR - <i>BLACK LACQUERED</i> SOIE NOIRE - <i>BLACK SILK</i>	71311716	 7 640163 973204
		CRISTAL INCOLORE - <i>CLEAR CRYSTAL</i> LAQUÉ NOIR - <i>BLACK LACQUERED</i> VELOURS CLASSIQUE, COULEUR CRÈME - <i>CLASSIC VELVET CREAM</i>	71311722	 7 640163 972719
<b>2016 - LADY TINA GREEN &amp; PIETRO MINGARELLI POUR LALIQUE</b>				

Autres couleurs et tissus disponibles sur demande. / *Others colours and fabrics available on request.*

# CHAISES CONTEMPORAINES - CONTEMPORARY CHAIRS

## RAISINS AVEC ACCOUDOIRS / WITH ARMRESTS



### FINITION / FINISHING



CRISTAL LUSTRÉ OR - GOLD LUSTER CRYSTAL  
LAQUÉ VERT - GREEN LACQUERED  
TISSU VERT - GREEN FABRIC

### REFERENCE

71372500

### EAN CODE



### 2018 - LADY TINA GREEN & PIETRO MINGARELLI POUR LALIQUE

Autres couleurs et tissus disponibles sur demande. / Others colours and fabrics available on request.

# CHAISES CLASSIQUES - CLASSIC CHAIRS

## MASQUE DE FEMME AVEC ACCOUDOIRS / WITH ARMRESTS



20 kg / 44.1 pounds

### FINITION / FINISHING

### REFERENCE

### EAN CODE

		CRISTAL INCOLORE - CLEAR CRYSTAL LAQUÉ NOIR - BLACK LACQUERED SOIE IVOIRE - IVORY SILK	10294700			
<b>2013 - LADY TINA GREEN &amp; PIETRO MINGARELLI POUR LALIQUE</b>				CRISTAL INCOLORE - CLEAR CRYSTAL LAQUÉ NOIR - BLACK LACQUERED CUIR IMPRIMÉ CROCO NOIR - LEATHER PRINTED BLACK CROCO	11294700	
<b>2014 - LADY TINA GREEN &amp; PIETRO MINGARELLI POUR LALIQUE</b>				CRISTAL INCOLORE - CLEAR CRYSTAL LAQUÉ NOIR - BLACK LACQUERED SOIE NOIRE - BLACK SILK	71311616	
<b>2016 - LADY TINA GREEN &amp; PIETRO MINGARELLI POUR LALIQUE</b>						

Autres couleurs et tissus disponibles sur demande. / Others colours and fabrics available on request.

# CHAISES CLASSIQUES - CLASSIC CHAIRS

## MASQUE DE FEMME SANS ACCOUDOIR / WITHOUT ARMREST



18,4 kg / 40.5 pounds

### FINITION / FINISHING

		REFERENCE	EAN CODE
		CRISTAL INCOLORE - CLEAR CRYSTAL LAQUÉ NOIR - BLACK LACQUERED SOIE IVOIRE - IVORY SILK	10294600
<b>2012 - LADY TINA GREEN &amp; PIETRO MINGARELLI POUR LALIQUE</b>			7 640111 496311
		CRISTAL INCOLORE - CLEAR CRYSTAL LAQUÉ NOIR - BLACK LACQUERED SOIE NOIRE - BLACK SILK	71311816
<b>2014 - LADY TINA GREEN &amp; PIETRO MINGARELLI POUR LALIQUE</b>			7 640111 509158
		CRISTAL INCOLORE - CLEAR CRYSTAL LAQUÉ NOIR - BLACK LACQUERED CUIR IMPRIMÉ CROCO NOIR - LEATHER PRINTED BLACK CROCO	11294600
<b>2015 - LADY TINA GREEN &amp; PIETRO MINGARELLI POUR LALIQUE</b>			7 640111 508939
		CRISTAL INCOLORE - CLEAR CRYSTAL LAQUÉ NOIR - BLACK LACQUERED VELOURS CLASSIQUE, COULEUR CRÈME - CLASSIC VELVET CREAM	71311822
<b>2015 - LADY TINA GREEN &amp; PIETRO MINGARELLI POUR LALIQUE</b>			7 640111 509592

Autres couleurs et tissus disponibles sur demande. / Others colours and fabrics available on request.

# FAUTEULS CONTEMPORAINS VILLA RENÉ LALIQUE

## VILLA RENÉ LALIQUE CONTEMPORARY ARMCHAIRS

### MASQUE DE FEMME AVEC ACCOUDOIRS / WITH ARMRESTS



20 kg / 44.1 pounds

Chenille medley / *Chenille medley*

FINITION / FINISHING

REFERENCE

EAN CODE

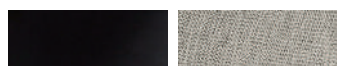

CRISTAL INCOLORE - CLEAR CRYSTAL  
LAQUÉ NOIR - BLACK LACQUERED  
CHENILLE MEDLEY - CHENILLE MEDLEY

71211024



**2016 - LADY TINA GREEN & PIETRO MINGARELLI POUR LALIQUE**

Autres couleurs et tissus disponibles sur demande. / Others colours and fabrics available on request.

# FAUTEULS CONTEMPORAINS VILLA RENÉ LALIQUE

## VILLA RENÉ LALIQUE CONTEMPORARY ARMCHAIRS

RAISINS

AVEC ACCOUDOIRS / WITH ARMRESTS



750 mm / 29.53"

20 kg / 44.1 pounds

FINITION / FINISHING

REFERENCE

EAN CODE



CRISTAL LUSTRÉ OR - GOLD LUSTER CRYSTAL  
LAQUÉ VERT - GREEN LACQUERED  
TISSU VERT - GREEN FABRIC

71272027



7 640182 870164



CRISTAL INCOLORE - CLEAR CRYSTAL  
LAQUÉ NOIR - BLACK LACQUERED  
VELOURS ROUGE - RED VELVET

71272032



7 640182 871413

2018 - LADY TINA GREEN & PIETRO MINGARELLI POUR LALIQUE

Autres couleurs et tissus disponibles sur demande. / Others colours and fabrics available on request.

# CHAISES DE BAR - *BARSTOOL*

## MASQUE DE FEMME SANS ACCOUDOIR / *WITHOUT ARMREST*



13 kg / 28.70 pounds

FINITION / *FINISHING*

REFERENCE

EAN CODE



CRISTAL INCOLORE - *CLEAR CRYSTAL*  
LAQUÉ NOIR - *BLACK LACQUERED*  
CUIR IMPRIMÉ CROCO NOIR - *LEATHER PRINTED BLACK CROCO*

71511362



7 640163 972139

**2016 - LADY TINA GREEN & PIETRO MINGARELLI POUR LALIQUE**

Autres couleurs et tissus disponibles sur demande. / *Others colours and fabrics available on request.*

230 - Assises - *Seatings*

# FAUTEUILS CLUB CLASSIQUES - CLASSIC CLUB ARMCHAIRS

RAISINS



39 kg / 86 pounds

FINITION / FINISHING	REFERENCE	EAN CODE
 CRISTAL INCOLORE - CLEAR CRYSTAL SOIE IVOIRE - IVORY SILK	10293800	 7 640111 496229
 CRISTAL INCOLORE - CLEAR CRYSTAL SOIE NOIRE - BLACK SILK	10293801	 7 640111 500162
<b>2012 - LADY TINA GREEN &amp; PIETRO MINGARELLI POUR LALIQUE</b>		
 CRISTAL INCOLORE - CLEAR CRYSTAL SOIE CRÈME - HEAVY CREAM SILK	71202015	 7 640111 509165
 CRISTAL INCOLORE - CLEAR CRYSTAL CUIR IVOIRE - IVORY LEATHER	71202063	 7 640163 975178
 CRISTAL INCOLORE - CLEAR CRYSTAL CUIR IMPRIMÉ CROCO IVOIRE LEATHER PRINTED IVORY CROCO	71202064	 7 640163 975734
<b>2015 - LADY TINA GREEN &amp; PIETRO MINGARELLI POUR LALIQUE</b>		

Autres couleurs et tissus disponibles sur demande. / Others colours and fabrics available on request.



# FAUTEUILS CLUB CONTEMPORAINS - CONTEMPORARY CLUB ARMCHAIRS

## MASQUE DE FEMME



1040 mm / 40.94"

61 kg / 134.50 pounds

Velour classique, couleur ébène / Classic velvet ebony



**CAPITONNÉ / DEEP QUILT**

Chenille crème / Chenille cream

### FINITION / FINISHING

		REFERENCE	EAN CODE
	CRISTAL INCOLORE - CLEAR CRYSTAL SOIE IVOIRE - IVORY SILK	10293700	
	CRISTAL INCOLORE - CLEAR CRYSTAL SOIE NOIRE - BLACK SILK	10293701	
<b>2012 - LADY TINA GREEN &amp; PIETRO MINGARELLI POUR LALIQUE</b>			
	CRISTAL INCOLORE - CLEAR CRYSTAL VELOURS CLASSIQUE, COULEUR LIN CLASSIC VELVET LINEN	71201021	
	CRISTAL INCOLORE - CLEAR CRYSTAL VELOURS CLASSIQUE, COULEUR ÉBÈNE CLASSIC VELVET EBONY	71201023	
	CRISTAL INCOLORE - CLEAR CRYSTAL CUIR IMPRIMÉ CROCO NOIR LEATHER PRINTED BLACK CROCO	71201062	
	CRISTAL INCOLORE - CLEAR CRYSTAL CHENILLE CRÈME CHENILLE HEAVY CREAM	71201012	
<b>2015 - LADY TINA GREEN &amp; PIETRO MINGARELLI POUR LALIQUE</b>			
	CRISTAL INCOLORE - CLEAR CRYSTAL CHENILLE IVOIRE CHENILLE IVORY	71201011	
<b>2016 - LADY TINA GREEN &amp; PIETRO MINGARELLI POUR LALIQUE</b>			
	CRISTAL INCOLORE - CLEAR CRYSTAL CHENILLE CRÈME, CAPITONNÉ CHENILLE CREAM, DEEP QUILT	71201412	
<b>2017 - LADY TINA GREEN &amp; PIETRO MINGARELLI POUR LALIQUE</b>			

Autres couleurs et tissus disponibles sur demande. / Others colours and fabrics available on request.

# FAUTEUILS - *ARMCHAIRS*

## LONGCHAMP

ÉDITION NUMÉROTÉE / *NUMBERED EDITION*



Finition cuir imprimé croco noir. /  
*Leather fabric printed black croco.*



730 mm / 28.74"

30 kg / 66 pounds

### FINITION / *FINISHING*

### REFERENCE

### EAN CODE

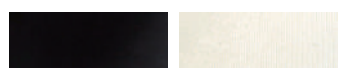

CRISTAL INCOLORE - *CLEAR CRYSTAL*  
LAQUÉ NOIR - *BLACK LACQUERED*  
SOIE IVOIRE - *IVORY SILK*

11294802



**2013 - LADY TINA GREEN & PIETRO MINGARELLI POUR LALIQUE**



CRISTAL INCOLORE - *CLEAR CRYSTAL*  
LAQUÉ NOIR - *BLACK LACQUERED*  
CUIR IMPRIMÉ CROCO NOIR - *LEATHER PRINTED BLACK CROCO*

11294850



**2014 - LADY TINA GREEN & PIETRO MINGARELLI POUR LALIQUE**

Autres couleurs et tissus disponibles sur demande. / *Others colours and fabrics available on request.*

# FAUTEUILS - *ARMCHAIRS*

## PANTHÈRE

ÉDITION NUMÉROTÉE / *NUMBERED EDITION*

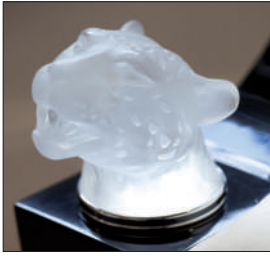

30 kg / 66 pounds

FINITION / *FINISHING*

REFERENCE

EAN CODE

  CRISTAL INCOLORE - *CLEAR CRYSTAL*  
LAQUÉ NOIR - *BLACK LACQUERED*  
SOIE IVOIRE - *IVORY SILK*

11294801



7 640111 496373

**2012 - LADY TINA GREEN & PIETRO MINGARELLI POUR LALIQUE**

  CRISTAL INCOLORE - *CLEAR CRYSTAL*  
LAQUÉ NOIR - *BLACK LACQUERED*  
CUIR IVOIRE - *IVORY LEATHER*

71318063



7 640163 975185















Autres couleurs et tissus disponibles sur demande. / *Others colours and fabrics available on request.*

# FAUTEUILS - *ARMCHAIRS*

## VICTOIRE

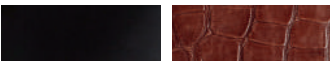
ÉDITION NUMÉROTÉE / *NUMBERED EDITION*



FINITION / <i>FINISHING</i>	REFERENCE	EAN CODE
 CRISTAL INCOLORE - <i>CLEAR CRYSTAL</i> LAQUÉ NOIR - <i>BLACK LACQUERED</i> SOIE IVOIRE - <i>IVORY SILK</i>	10294800	 7 640111 496335
<b>2011 - LADY TINA GREEN &amp; PIETRO MINGARELLI POUR LALIQUE</b>		
 CRISTAL INCOLORE - <i>CLEAR CRYSTAL</i> LAQUÉ NOIR - <i>BLACK LACQUERED</i> CHENILLE IVOIRE - <i>IVORY CHENILLE</i>	10294810	 7 640111 506232
<b>2013 - LADY TINA GREEN &amp; PIETRO MINGARELLI POUR LALIQUE</b>		
 CRISTAL INCOLORE - <i>CLEAR CRYSTAL</i> LAQUÉ NOIR - <i>BLACK LACQUERED</i> CUIR IMPRIMÉ CROCO NOIR - <i>LEATHER PRINTED BLACK CROCO</i>	10294850	 7 640111 508670
<b>2013 - LADY TINA GREEN &amp; PIETRO MINGARELLI POUR LALIQUE</b>		
 CRISTAL INCOLORE - <i>CLEAR CRYSTAL</i> LAQUÉ NOIR - <i>BLACK LACQUERED</i> VELOURS CLASSIQUE, COULEUR CRÈME - <i>CLASSIC VELVET CREAM</i>	71216022	 7 640111 509608
 CRISTAL INCOLORE - <i>CLEAR CRYSTAL</i> LAQUÉ NOIR - <i>BLACK LACQUERED</i> CUIR IVOIRE - <i>IVORY LEATHER</i>	71216063	 7 640163 975604
 CRISTAL INCOLORE - <i>CLEAR CRYSTAL</i> LAQUÉ NOIR - <i>BLACK LACQUERED</i> CUIR SOFIA CHOCOLAT - <i>SOFIA CHOCOLATE LEATHER</i>	71316066	 7 640163 975710
<b>2015 - LADY TINA GREEN &amp; PIETRO MINGARELLI POUR LALIQUE</b>		
 CRISTAL INCOLORE - <i>CLEAR CRYSTAL</i> LAQUÉ VERT - <i>GREEN LACQUERED</i> VELOURS VERT - <i>GREEN VELVET</i>	71276032	 7 640182 871352
<b>2018 - LADY TINA GREEN &amp; PIETRO MINGARELLI POUR LALIQUE</b>		

Autres couleurs et tissus disponibles sur demande. / *Others colours and fabrics available on request.*

## MASQUE DE FEMME

ÉDITION NUMÉROTÉE / *NUMBERED EDITION*

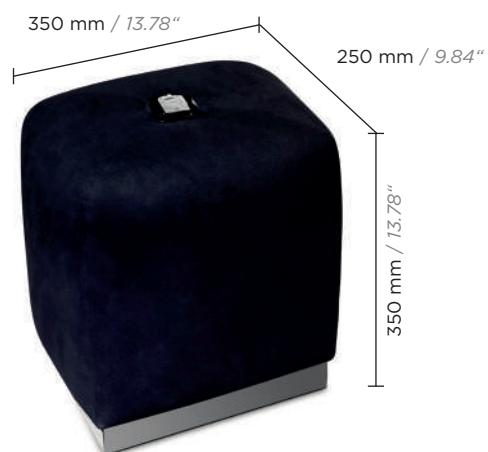

**PM / SS**

**4 kg / 8.82 pounds**

Soie noire / *Black silk*  
pour sac à main / *for handbag*



**MM / MS**

**34 kg / 75 pounds**

Soie ivoire / *Ivory silk*



**GM / LS**

**97 kg / 210 pounds**

Cuir imprimé croco noir / *Leather fabric printed black croco*

## MASQUE DE FEMME

ÉDITION NUMÉROTÉE / *NUMBERED EDITION*



FINITION / *FINISHING*

REFERENCE

EAN CODE



PM / SS



CRISTAL INCOLORE - *CLEAR CRYSTAL*  
LAQUÉ NOIR - *BLACK LACQUERED*  
SOIE NOIRE - *BLACK SILK*

71401116



**2016 - LADY TINA GREEN & PIETRO MINGARELLI POUR LALIQUE**

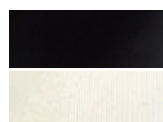

CRISTAL INCOLORE - *CLEAR CRYSTAL*  
LAQUÉ NOIR - *BLACK LACQUERED*  
SOIE IVOIRE - *IVORY SILK*

10180800



CRISTAL INCOLORE - *CLEAR CRYSTAL*  
LAQUÉ NOIR - *BLACK LACQUERED*  
CUIR IVOIRE - *IVORY LEATHER*

10180700



**2012 - LADY TINA GREEN & PIETRO MINGARELLI POUR LALIQUE**



MM / MS

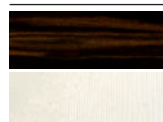

CRISTAL INCOLORE - *CLEAR CRYSTAL*  
ÉBÈNE NATUREL - *NATURAL EBONY*  
SOIE IVOIRE - *IVORY SILK*

10180801



**2014 - LADY TINA GREEN & PIETRO MINGARELLI POUR LALIQUE**



CRISTAL INCOLORE - *CLEAR CRYSTAL*  
BLEU EUCALYPTUS - *BLUE EUCALYPTUS*  
SOIE INDIGO - *INDIGO SILK*

71451018



CRISTAL INCOLORE - *CLEAR CRYSTAL*  
BLEU EUCALYPTUS - *BLUE EUCALYPTUS*  
CUIR IMPRIMÉ CROCO NOIR  
*LEATHER PRINTED BLACK CROCO*

71451062



**2015 - LADY TINA GREEN & PIETRO MINGARELLI POUR LALIQUE**



CRISTAL INCOLORE - *CLEAR CRYSTAL*  
BLEU EUCALYPTUS - *BLUE EUCALYPTUS*  
CUIR IMPRIMÉ CROCO IVOIRE -  
*LEATHER PRINTED IVORY CROCO*

71451064



**2016 - LADY TINA GREEN & PIETRO MINGARELLI POUR LALIQUE**



GM / LS



CRISTAL INCOLORE - *CLEAR CRYSTAL*  
SOIE IVOIRE - *IVORY SILK*

10294300



CRISTAL INCOLORE - *CLEAR CRYSTAL*  
CUIR IMPRIMÉ CROCO NOIR  
*LEATHER PRINTED BLACK CROCO*

10294200



**2012 - LADY TINA GREEN & PIETRO MINGARELLI POUR LALIQUE**



CRISTAL INCOLORE - *CLEAR CRYSTAL*  
CUIR IMPRIMÉ CROCO IVOIRE  
*LEATHER PRINTED IVORY CROCO*

71401361



**2018 - LADY TINA GREEN & PIETRO MINGARELLI POUR LALIQUE**

# OTTOMANS - OTTOMANS

## RAISINS

ÉDITION NUMÉROTÉE / *NUMBERED EDITION*

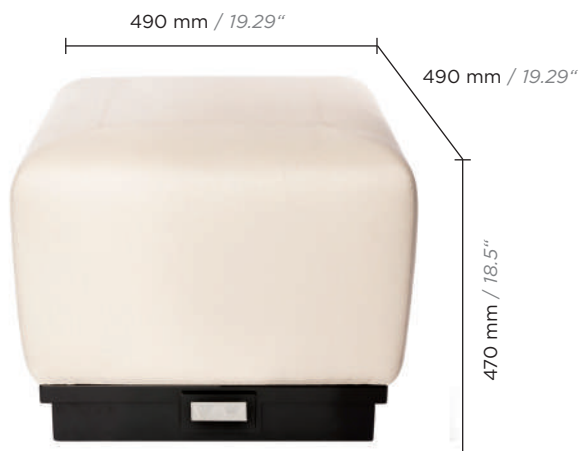

**PM CARRÉ / SS, SQUARE**

15 kg / 33.10 pounds

Soie ivoire / *Ivory silk*



Tissu vert / *Green fabric*

FINITION / *FINISHING*

REFERENCE

EAN CODE

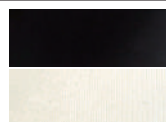

CRISTAL INCOLORE - *CLEAR CRYSTAL*  
LAQUÉ NOIR - *BLACK LACQUERED*  
SOIE IVOIRE - *IVORY SILK*

10180900



**2013 - LADY TINA GREEN & PIETRO MINGARELLI POUR LALIQUE**

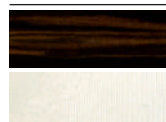

CRISTAL INCOLORE - *CLEAR CRYSTAL*  
ÉBÈNE NATUREL - *NATURAL EBONY*  
SOIE IVOIRE - *IVORY SILK*

10180910



**2014 - LADY TINA GREEN & PIETRO MINGARELLI POUR LALIQUE**

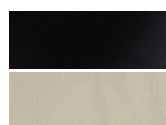

CRISTAL INCOLORE - *CLEAR CRYSTAL*  
LAQUÉ NOIR - *BLACK LACQUERED*  
CUIR IVOIRE - *IVORY LEATHER*

71412163



**PM CARRÉ / SS, SQUARE**



CRISTAL INCOLORE - *CLEAR CRYSTAL*  
LAQUÉ NOIR - *BLACK LACQUERED*  
SOIE INDIGO - *INDIGO SILK*

10180912



CRISTAL INCOLORE - *CLEAR CRYSTAL*  
LAQUÉ NOIR - *BLACK LACQUERED*  
CHENILLE CRÈME - *CHENILLE HEAVY CREAM*

71412112



CRISTAL INCOLORE - *CLEAR CRYSTAL*  
FRÈNE IVOIRE - *IVORY ASH*  
SOIE IVOIRE - *IVORY SILK*

71442014



**2015 - LADY TINA GREEN & PIETRO MINGARELLI POUR LALIQUE**

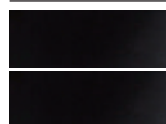

CRISTAL INCOLORE - *CLEAR CRYSTAL*  
LAQUÉ NOIR - *BLACK LACQUERED*  
SOIE NOIR - *BLACK SILK*

71412116



CRISTAL LUSTRÉ OR - *GOLD LUSTER CRYSTAL*  
CHÈNE SPÉCIAL - *SPECIAL OAK*  
BOIS NATUREL - *NATURAL WOOD*  
TISSU VERT - *GREEN FABRIC*

71492110



**2018 - LADY TINA GREEN & PIETRO MINGARELLI POUR LALIQUE**

Autres couleurs et tissus disponibles sur demande. / *Others colours and fabrics available on request.*

# OTTOMANS - OTTOMANS

## RAISINS

ÉDITION NUMÉROTÉE / *NUMBERED EDITION*



MM / MS

34 kg / 75 pounds

FINITION / *FINISHING*

REFERENCE

EAN CODE

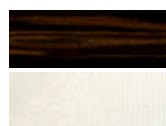

CRISTAL INCOLORE - *CLEAR CRYSTAL*  
ÉBÈNE NATUREL - *NATURAL EBONY*  
SOIE IVOIRE - *IVORY SILK*

10180810



**2013 - LADY TINA GREEN & PIETRO MINGARELLI POUR LALIQUE**

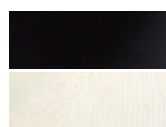

CRISTAL INCOLORE - *CLEAR CRYSTAL*  
LAQUÉ NOIR - *BLACK LACQUERED*  
SOIE IVOIRE - *IVORY SILK*

71412014



CRISTAL INCOLORE - *CLEAR CRYSTAL*  
ÉBÈNE NATUREL - *NATURAL EBONY*  
SOIE INDIGO - *INDIGO SILK*

10180812



**2014 - LADY TINA GREEN & PIETRO MINGARELLI POUR LALIQUE**



MM / MS

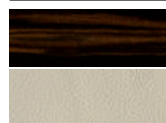

CRISTAL INCOLORE - *CLEAR CRYSTAL*  
ÉBÈNE NATUREL - *NATURAL EBONY*  
CUIR IVOIRE - *IVORY LEATHER*

71422063



**2015 - LADY TINA GREEN & PIETRO MINGARELLI POUR LALIQUE**



CRISTAL INCOLORE - *CLEAR CRYSTAL*  
BLEU EUCALYPTUS - *BLUE EUCALYPTUS*  
CUIR IVOIRE - *IVORY LEATHER*

71452063



CRISTAL INCOLORE - *CLEAR CRYSTAL*  
BLEU EUCALYPTUS - *BLUE EUCALYPTUS*  
CUIR CROCO IVOIRE - *LEATHER IVORY CROCO*

71452064



CRISTAL INCOLORE - *CLEAR CRYSTAL*  
ÉBÈNE NATUREL - *NATURAL EBONY*  
CUIR CROCO IVOIRE - *LEATHER IVORY CROCO*

71422064



**2018 - LADY TINA GREEN & PIETRO MINGARELLI POUR LALIQUE**

Autres couleurs et tissus disponibles sur demande. / *Others colours and fabrics available on request.*





AUTRE MOBILIER - *OTHER FURNITURE*



# CADRES TV - TV FRAMES SURROUND

## RAISINS

ÉDITION NUMÉROTÉE / NUMBERED EDITION

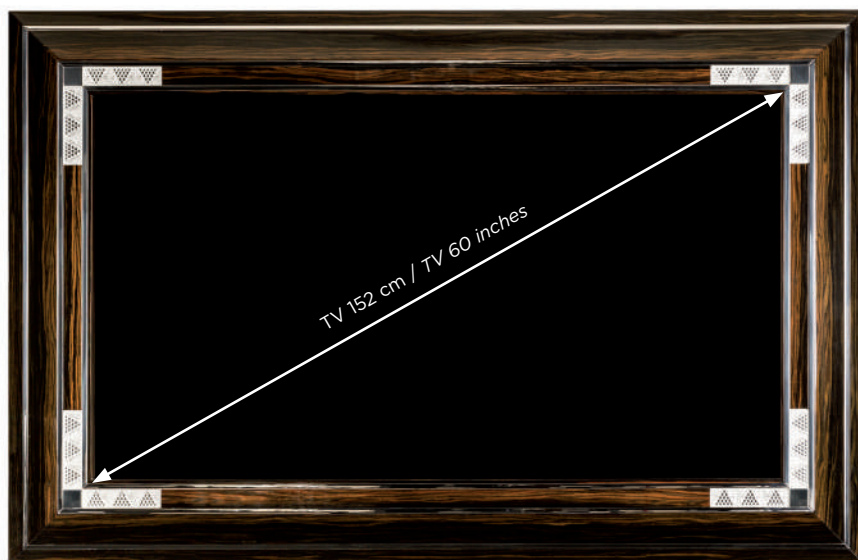

50 kg / 110.20 pounds

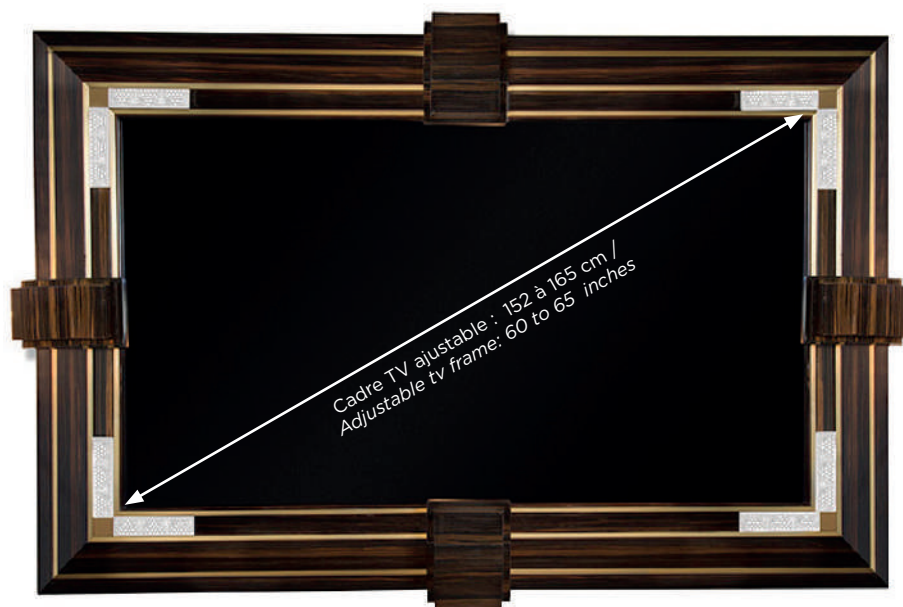

FINITION / FINISHING

REFERENCE

EAN CODE



CRISTAL INCOLORE - CLEAR CRYSTAL  
ÉBÈNE NATUREL - NATURAL EBONY

11186000



**2013 - LADY TINA GREEN & PIETRO MINGARELLI POUR LALIQUE**

Pour TV de 60". Modèle de TV à spécifier lors de la commande. / For 60" TV. Precise the TV dimensions when ordering.



CRISTAL INCOLORE - CLEAR CRYSTAL  
LAQUÉ NOIR - BLACK LACQUERED

75212000



**2016 - LADY TINA GREEN & PIETRO MINGARELLI POUR LALIQUE**

Pour TV de 60". Modèle de TV à spécifier lors de la commande. / For 60" TV. Precise the TV dimensions when ordering.

**CADRE TV ADAPTABLE - TV FRAME SURROUND ADJUSTABLE**



CRISTAL INCOLORE - CLEAR CRYSTAL  
ÉBÈNE NATUREL - NATURAL EBONY  
ACIER DORÉ SATINÉ - INOX GOLDEN SATIN STEEL

75222002



**2015 - LADY TINA GREEN & PIETRO MINGARELLI POUR LALIQUE**

MASQUE DE FEMME

ÉDITION NUMÉROTÉE / *NUMBERED EDITION*



1480 mm / 58.27"

960 mm / 37.80"

18 kg / 39.7 pounds

FINITION / *FINISHING*

REFERENCE

EAN CODE

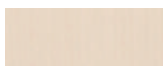

CRISTAL INCOLORE - *CLEAR CRYSTAL*  
FRÊNE IVOIRE - *IVORY ASH*

11185400



**2011 - LADY TINA GREEN & PIETRO MINGARELLI POUR LALIQUE**



CRISTAL INCOLORE - *CLEAR CRYSTAL*  
LAQUÉ NOIR - *BLACK LACQUERED*

10185400



**2012 - LADY TINA GREEN & PIETRO MINGARELLI POUR LALIQUE**



CRISTAL INCOLORE - *CLEAR CRYSTAL*  
ÉBÈNE NATUREL - *NATURAL EBONY*

75121000



**2015 - LADY TINA GREEN & PIETRO MINGARELLI POUR LALIQUE**

# MIROIRS - MIRRORS

## RAISINS



45 kg / 99.20 pounds



45 kg / 99.20 pounds

FINITION / FINISHING	REFERENCE	EAN CODE
   <p>CRISTAL LUSTRÉ OR - GOLD LUSTER CRYSTAL BOIS NATUREL - NATURAL WOOD</p> <p>PM / SS</p>	75153006	 <p>7 640182 870072</p>
   <p>CRISTAL LUSTRÉ OR - GOLD LUSTER CRYSTAL BOIS NATUREL - NATURAL WOOD</p> <p>GM / LS</p>	75153406	 <p>7 640182 870065</p>

2018 - LADY TINA GREEN & PIETRO MINGARELLI POUR LALIQUE



1380 mm / 54.33"

960 mm / 37.80"

45 kg / 99.20 pounds

Laqué noir - Acier doré / *Black lacquered - inox golden satin steel*



1750 mm / 68.90"

960 mm / 37.80"

Laqué noir / *Black lacquered*

### FINITION / FINISHING

### REFERENCE

### EAN CODE



CRISTAL INCOLORE - *CLEAR CRYSTAL*  
LAQUÉ NOIR - *BLACK LACQUERED*

10185300



CRISTAL INCOLORE - *CLEAR CRYSTAL*  
FRÊNE IVOIRE - *IVORY ASH*

11185300



**2012 - LADY TINA GREEN & PIETRO MINGARELLI POUR LALIQUE**

**L1380 x 1960 mm**  
**L54.33" x W37.80"**



CRISTAL INCOLORE - *CLEAR CRYSTAL*  
ÉBÈNE NATUREL - *NATURAL EBONY*

75122000



**2015 - LADY TINA GREEN & PIETRO MINGARELLI POUR LALIQUE**



CRISTAL INCOLORE - *CLEAR CRYSTAL*  
LAQUÉ NOIR - *BLACK LACQUERED*  
ACIER DORÉ SATINÉ - *INOX GOLDEN SATIN STEEL*

75103401



**2016 - LADY TINA GREEN & PIETRO MINGARELLI POUR LALIQUE**

**L1750 x 1960 mm**  
**L68.90" x W37.80"**



CRISTAL INCOLORE - *CLEAR CRYSTAL*  
LAQUÉ NOIR - *BLACK LACQUERED*

75112300



**2015 - LADY TINA GREEN & PIETRO MINGARELLI POUR LALIQUE**

## RAISINS

COURBÉ / *CURVED*

ÉDITION NUMÉROTÉE / *NUMBERED EDITION*



FINITION / *FINISHING*



CRISTAL INCOLORE - *CLEAR CRYSTAL*  
LAQUÉ NOIR - *BLACK LACQUERED*

REFERENCE

75103130

EAN CODE



7 640163 973556

**2017 - LADY TINA GREEN & PIETRO MINGARELLI POUR LALIQUE**



FINITION / *FINISHING*

REFERENCE

EAN CODE

	CRISTAL INCOLORE - <i>CLEAR CRYSTAL</i> LAQUÉ NOIR - <i>BLACK LACQUERED</i>	10185501	 7 640111 509554
	CRISTAL INCOLORE - <i>CLEAR CRYSTAL</i> BLEU EUCALYPTUS - <i>BLUE EUCALYPTUS</i>	75150000	 7 640111 509493
	CRISTAL INCOLORE - <i>CLEAR CRYSTAL</i> ÉBÈNE NATUREL - <i>NATURAL EBONY</i>	11185500	 7 640111 508526
	CRISTAL INCOLORE - <i>CLEAR CRYSTAL</i> FRÊNE IVOIRE - <i>IVORY ASH</i>	75144000	 7 640163 975673

2014 - LADY TINA GREEN & PIETRO MINGARELLI POUR LALIQUE



TIANLONG



Photo non contractuelle / *Non contractual picture*

FINITION / *FINISHING*

REFERENCE

EAN CODE



CRISTAL INCOLORE - *CLEAR CRYSTAL*  
 LAQUÉ NOIR - *BLACK LACQUERED*  
 ACIER DORÉ SATINÉ - *INOX GOLDEN SATIN STEEL*

75115001



**2015 - LADY TINA GREEN & PIETRO MINGARELLI POUR LALIQUE**

# LITS - BEDS

## MASQUE DE FEMME

ÉDITION NUMÉROTÉE / NUMBERED EDITION

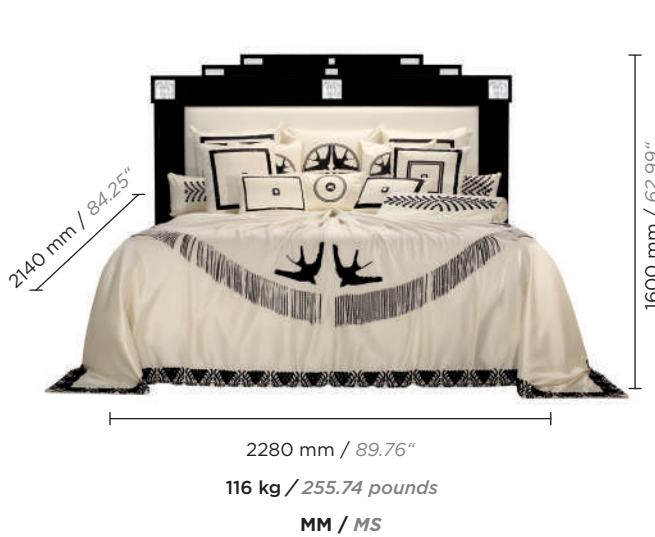

Laqué noir - soie ivoire / Black lacquered - ivory silk



Frêne ivoire - soie ivoire / Ivory ash - ivory silk

### FINITION / FINISHING

### REFERENCE

### EAN CODE



CRISTAL INCOLORE - CLEAR CRYSTAL  
FRÊNE IVOIRE - IVORY ASH  
SOIE IVOIRE - IVORY SILK

10183500



7 640111 494188



CRISTAL INCOLORE - CLEAR CRYSTAL  
LAQUÉ NOIR - BLACK LACQUERED  
SOIE IVOIRE - IVORY SILK

10183300



7 640111 494140

**MM / MS**  
Matelas 180 x 200 cm  
Mattress 180 x 200 cm



CRISTAL INCOLORE - CLEAR CRYSTAL  
FRÊNE IVOIRE - IVORY ASH  
SOIE IVOIRE - IVORY SILK

10183900



7 640111 494287

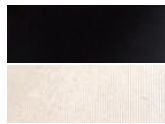

CRISTAL INCOLORE - CLEAR CRYSTAL  
LAQUÉ NOIR - BLACK LACQUERED  
SOIE IVOIRE - IVORY SILK

10183700



7 640111 494195

**GM / LS**  
Matelas 200 x 200 cm  
Mattress 200 x 200 cm

### 2011 - LADY TINA GREEN & PIETRO MINGARELLI POUR LALIQUE

Lit et tête de lit livrés sans matelas, ni sommier. / Bedframe and head-board delivered without mattress neither bedbase.

Le linge de lit figurant sur cette page n'est pas vendu avec la gamme de lits. / The bed linen feature at this page is not sold with the bed range.

# LITS - BEDS

## RAISINS

ÉDITION NUMÉROTÉE / NUMBERED EDITION



2140 mm / 84.25"

1600 mm / 62.99"

2280 mm / 89.76"

116 kg / 255.74 pounds

**MM / MS**

Laqué noir - soie ivoire / Black lacquered - ivory silk



2140 mm / 84.25"

1600 mm / 62.99"

2480 mm / 97.64"

171 kg / 377 pounds

**GM / LS**

Bois naturel - tissu vert / Natural wood - green fabric

### FINITION / FINISHING

### REFERENCE

### EAN CODE

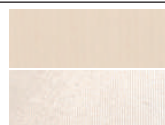

CRISTAL INCOLORE - CLEAR CRYSTAL  
FRÊNE IVOIRE - IVORY ASH  
SOIE IVOIRE - IVORY SILK

10181500



7 640111 494089

**MM / MS**  
Matelas 180 x 200 cm  
Mattress 180 x 200 cm



CRISTAL INCOLORE - CLEAR CRYSTAL  
LAQUÉ NOIR - BLACK LACQUERED  
SOIE IVOIRE - IVORY SILK

10181300



7 640111 505358



CRISTAL INCOLORE - CLEAR CRYSTAL  
FRÊNE IVOIRE - IVORY ASH  
SOIE IVOIRE - IVORY SILK

10181900



7 640111 494102

**GM / LS**  
Matelas 200 x 200 cm  
Mattress 200 x 200 cm



CRISTAL INCOLORE - CLEAR CRYSTAL  
LAQUÉ NOIR - BLACK LACQUERED  
SOIE IVOIRE - IVORY SILK

10181700



7 640111 494096

### 2011 - LADY TINA GREEN & PIETRO MINGARELLI POUR LALIQUE

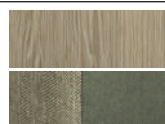

CRISTAL LUSTRÉ OR - GOLD LUSTER CRYSTAL  
BOIS NATUREL - NATURAL WOOD  
TISSU VERT - GREEN FABRIC

74162100



7 640182 870003

### 2018 - LADY TINA GREEN & PIETRO MINGARELLI POUR LALIQUE

Lit et tête de lit livrés sans matelas, ni sommier. / Bedframe and head-board delivered without mattress neither bedbase.

Le linge de lit figurant sur cette page n'est pas vendu avec la gamme de lits. / The bed linen feature at this page is not sold with the bed range.

LINGE DE MAISON - *SOFT FURNISHING*



# COUSSINS BRODÉS - EMBROIDERED CUSHIONS













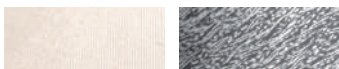

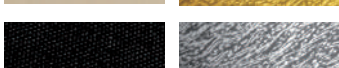

## 2 POISSONS / KOI CIRCLE

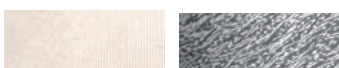

**CARRÉ / SQUARE**

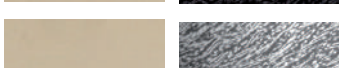

**RECTANGULAIRE / RECTANGULAR**











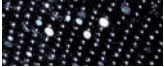







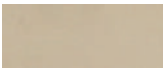
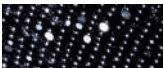

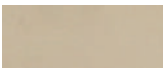
FINITION / FINISHING	REFERENCE	EAN CODE
 <p><b>CARRÉ SQUARE</b></p> <p><b>500x500 mm 19.68" x 19.68"</b></p>	 <p>SOIE IVOIRE - <i>IVORY SILK</i> BRODÉ NOIR - <i>BLACK EMBROIDERY</i></p>	11602110 7 640111 504689
	 <p>SOIE IVOIRE - <i>IVORY SILK</i> BRODÉ ARGENT - <i>SILVER EMBROIDERY</i></p>	11602120 7 640111 504696
	 <p>SOIE IVOIRE - <i>IVORY SILK</i> BRODÉ OR - <i>GOLD EMBROIDERY</i></p>	11602130 7 640111 504702
	 <p>SOIE PLATINE - <i>PLATINUM SILK</i> BRODÉ NOIR - <i>BLACK EMBROIDERY</i></p>	11602140 7 640111 504719
	 <p>SOIE PLATINE - <i>PLATINUM SILK</i> BRODÉ ARGENT - <i>SILVER EMBROIDERY</i></p>	11602150 7 640111 504726
	 <p>SOIE PLATINE - <i>PLATINUM SILK</i> BRODÉ OR - <i>GOLD EMBROIDERY</i></p>	11602160 7 640111 504733
	 <p>SOIE NOIRE - <i>BLACK SILK</i> BRODÉ ARGENT - <i>SILVER EMBROIDERY</i></p>	11602170 7 640111 504740
	 <p>SOIE NOIRE - <i>BLACK SILK</i> BRODÉ OR - <i>GOLD EMBROIDERY</i></p>	11602180 7 640111 504757
 <p><b>RECTANGULAIRE RECTANGULAR</b></p> <p><b>560 x 400 mm 22.04" x 15.74"</b></p>	 <p>SOIE IVOIRE - <i>IVORY SILK</i> BRODÉ NOIR - <i>BLACK EMBROIDERY</i></p>	11602210 7 640111 504764
	 <p>SOIE IVOIRE - <i>IVORY SILK</i> BRODÉ ARGENT - <i>SILVER EMBROIDERY</i></p>	11602220 7 640111 504771
	 <p>SOIE IVOIRE - <i>IVORY SILK</i> BRODÉ OR - <i>GOLD EMBROIDERY</i></p>	11602230 7 640111 504788
	 <p>SOIE PLATINE - <i>PLATINUM SILK</i> BRODÉ NOIR - <i>BLACK EMBROIDERY</i></p>	11602240 7 640111 504795
	 <p>SOIE PLATINE - <i>PLATINUM SILK</i> BRODÉ ARGENT - <i>SILVER EMBROIDERY</i></p>	11602250 7 640111 504801
	 <p>SOIE PLATINE - <i>PLATINUM SILK</i> BRODÉ OR - <i>GOLD EMBROIDERY</i></p>	11602260 7 640111 504818
	 <p>SOIE NOIRE - <i>BLACK SILK</i> BRODÉ ARGENT - <i>SILVER EMBROIDERY</i></p>	11602270 7 640111 504825
	 <p>SOIE NOIRE - <i>BLACK SILK</i> BRODÉ OR - <i>GOLD EMBROIDERY</i></p>	11602280 7 640111 504832

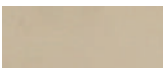
2011 - LADY TINA GREEN & PIETRO MINGARELLI POUR LALIQUE

# COUSSINS PERLÉS - *BEADED CUSHIONS*

## CHEVAL BONDISSANT / *LEAPING HORSE*

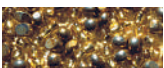









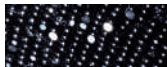





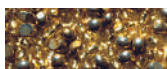







FINITION / FINISHING			REFERENCE	EAN CODE
		SOIE IVOIRE - <i>IVORY SILK</i> PERLÉ NOIR - <i>BLACK GLASS BEADS</i>	11603310	 7 640111 505082
		SOIE IVOIRE - <i>IVORY SILK</i> PERLÉ ARGENT - <i>SILVER GLASS BEADS</i>	11603320	 7 640111 505099
		SOIE IVOIRE - <i>IVORY SILK</i> PERLÉ OR - <i>GOLD GLASS BEADS</i>	11603330	 7 640111 505105
		SOIE PLATINE - <i>PLATINUM SILK</i> PERLÉ NOIR - <i>BLACK GLASS BEADS</i>	11603340	 7 640111 505112
		SOIE PLATINE - <i>PLATINUM SILK</i> PERLÉ ARGENT - <i>SILVER GLASS BEADS</i>	11603350	 7 640111 505129
		SOIE PLATINE - <i>PLATINUM SILK</i> PERLÉ OR - <i>GOLD GLASS BEADS</i>	11603360	 7 640111 505228
		SOIE NOIRE - <i>BLACK SILK</i> PERLÉ ARGENT - <i>SILVER GLASS BEADS</i>	11603370	 7 640111 505143
		SOIE NOIRE - <i>BLACK SILK</i> PERLÉ OR - <i>GOLD GLASS BEADS</i>	11603380	 7 640111 505235

# COUSSINS PERLÉS - *BEADED CUSHIONS*

## CHEVAL DEBOUT / *STANDING HORSE*



FINITION / FINISHING		REFERENCE	EAN CODE
		SOIE IVOIRE - <i>IVORY SILK</i> PERLÉ NOIR - <i>BLACK GLASS BEADS</i>	11603210  7 640111 505006
		SOIE IVOIRE - <i>IVORY SILK</i> PERLÉ ARGENT - <i>SILVER GLASS BEADS</i>	11603220  7 640111 505013
		SOIE IVOIRE - <i>IVORY SILK</i> PERLÉ OR - <i>GOLD GLASS BEADS</i>	11603230  7 640111 505020
		SOIE PLATINE - <i>PLATINUM SILK</i> PERLÉ NOIR - <i>BLACK GLASS BEADS</i>	11603240  7 640111 505037
		SOIE PLATINE - <i>PLATINUM SILK</i> PERLÉ ARGENT - <i>SILVER GLASS BEADS</i>	11603250  7 640111 505044
		SOIE PLATINE - <i>PLATINUM SILK</i> PERLÉ OR - <i>GOLD GLASS BEADS</i>	11603260  7 640111 505051
		SOIE NOIRE - <i>BLACK SILK</i> PERLÉ ARGENT - <i>SILVER GLASS BEADS</i>	11603270  7 640111 505068
		SOIE NOIRE - <i>BLACK SILK</i> PERLÉ OR - <i>GOLD GLASS BEADS</i>	11603280  7 640111 505075

2011 - LADY TINA GREEN & PIETRO MINGARELLI POUR LALIQUE

# COUSSINS PERLÉS - *BEADED CUSHIONS*

COUTARD



450 mm / 17.71"

PM / SS









































650 mm / 25.59"

GM / LS

## FINITION / FINISHING

## REFERENCE

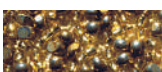
## EAN CODE









 <b>PM / SS</b>	 	SOIE IVOIRE - <i>IVORY SILK</i> PERLÉ NOIR - <i>BLACK GLASS BEADS</i>	10194800	 7 640111 496663
	 	SOIE IVOIRE - <i>IVORY SILK</i> PERLÉ ARGENT - <i>SILVER GLASS BEADS</i>	10194801	 7 640111 499411
	 	SOIE IVOIRE - <i>IVORY SILK</i> PERLÉ OR - <i>GOLD GLASS BEADS</i>	10194802	 7 640111 499428
	 	SOIE NOIRE - <i>BLACK SILK</i> PERLÉ NOIR - <i>BLACK GLASS BEADS</i>	10194900	 7 640111 496670
	 	SOIE NOIRE - <i>BLACK SILK</i> PERLÉ ARGENT - <i>SILVER GLASS BEADS</i>	10194901	 7 640111 499435
	 	SOIE NOIRE - <i>BLACK SILK</i> PERLÉ OR - <i>GOLD GLASS BEADS</i>	10194902	 7 640111 499442
 <b>GM / LS</b>	 	SOIE IVOIRE - <i>IVORY SILK</i> PERLÉ NOIR - <i>BLACK GLASS BEADS</i>	10194400	 7 640111 497714
	 	SOIE IVOIRE - <i>IVORY SILK</i> PERLÉ ARGENT - <i>SILVER GLASS BEADS</i>	10194401	 7 640111 499336
	 	SOIE IVOIRE - <i>IVORY SILK</i> PERLÉ OR - <i>GOLD GLASS BEADS</i>	10194402	 7 640111 499343
	 	SOIE NOIRE - <i>BLACK SILK</i> PERLÉ NOIR - <i>BLACK GLASS BEADS</i>	10194500	 7 640111 496656
	 	SOIE NOIRE - <i>BLACK SILK</i> PERLÉ ARGENT - <i>SILVER GLASS BEADS</i>	10194501	 7 640111 499398
	 	SOIE NOIRE - <i>BLACK SILK</i> PERLÉ OR - <i>GOLD GLASS BEADS</i>	10194502	 7 640111 499404

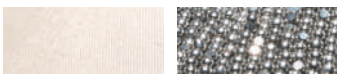

# COUSSINS PERLÉS - *BEADED CUSHIONS*

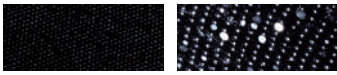
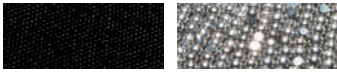
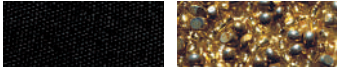
## DEMI COUTARD

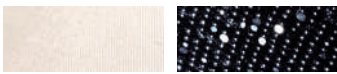

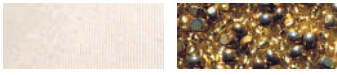
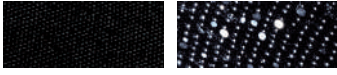
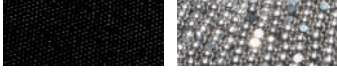
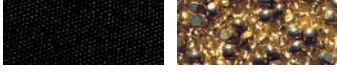
FINITION / FINISHING	REFERENCE	EAN CODE
 <b>PM / SS</b>	 SOIE IVOIRE - <i>IVORY SILK</i> PERLÉ NOIR - <i>BLACK GLASS BEADS</i>	10201200 7 640111 496700
	 SOIE IVOIRE - <i>IVORY SILK</i> PERLÉ ARGENT - <i>SILVER GLASS BEADS</i>	10201201 7 640111 499497
	 SOIE IVOIRE - <i>IVORY SILK</i> PERLÉ OR - <i>GOLD GLASS BEADS</i>	10201202 7 640111 505419
	 SOIE NOIRE - <i>BLACK SILK</i> PERLÉ NOIR - <i>BLACK GLASS BEADS</i>	10201000 7 640111 496717
	 SOIE NOIRE - <i>BLACK SILK</i> PERLÉ ARGENT - <i>SILVER GLASS BEADS</i>	10201001 7 640111 505426
	 SOIE NOIRE - <i>BLACK SILK</i> PERLÉ OR - <i>GOLD GLASS BEADS</i>	10201002 7 640111 505433
 <b>GM / LS</b>	 SOIE IVOIRE - <i>IVORY SILK</i> PERLÉ NOIR - <i>BLACK GLASS BEADS</i>	10201100 7 640111 496687
	 SOIE IVOIRE - <i>IVORY SILK</i> PERLÉ ARGENT - <i>SILVER GLASS BEADS</i>	10201101 7 640111 499459
	 SOIE IVOIRE - <i>IVORY SILK</i> PERLÉ OR - <i>GOLD GLASS BEADS</i>	10201102 7 640111 499466
	 SOIE NOIRE - <i>BLACK SILK</i> PERLÉ NOIR - <i>BLACK GLASS BEADS</i>	10200900 7 640111 496694
	 SOIE NOIRE - <i>BLACK SILK</i> PERLÉ ARGENT - <i>SILVER GLASS BEADS</i>	10200901 7 640111 499473
	 SOIE NOIRE - <i>BLACK SILK</i> PERLÉ OR - <i>GOLD GLASS BEADS</i>	10200902 7 640111 499480

2011 - LADY TINA GREEN & PIETRO MINGARELLI POUR LALIQUE

# COUSSINS PERLÉS - *BEADED CUSHIONS*

DRAGON



FINITION / FINISHING		REFERENCE	EAN CODE
		SOIE IVOIRE - <i>IVORY SILK</i> PERLÉ NOIR - <i>BLACK GLASS BEADS</i>	11603410  7 640111 505167
		SOIE IVOIRE - <i>IVORY SILK</i> PERLÉ ARGENT - <i>SILVER GLASS BEADS</i>	11603420  7 640111 505174
		SOIE IVOIRE - <i>IVORY SILK</i> PERLÉ OR - <i>GOLD GLASS BEADS</i>	11603430  7 640111 505181
		SOIE NOIRE - <i>BLACK SILK</i> PERLÉ ROUGE - <i>RED GLASS BEADS</i>	11603440  7 640111 505198
		SOIE NOIRE - <i>BLACK SILK</i> PERLÉ ARGENT - <i>SILVER GLASS BEADS</i>	11603450  7 640111 505204
		SOIE NOIRE - <i>BLACK SILK</i> PERLÉ OR - <i>GOLD GLASS BEADS</i>	11603460  7 640111 505211

2011 - LADY TINA GREEN & PIETRO MINGARELLI POUR LALIQUE

# COUSSINS PERLÉS - *BEADED CUSHIONS*

## HIRONDELLES



500 mm / 19.68"

500 mm / 19.68"

**MM / MS**



600 mm / 23.62"













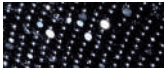























600 mm / 23.62"

**GM / LS**

### FINITION / FINISHING

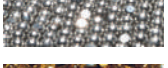
### REFERENCE

### EAN CODE

 <p><b>MM / MS</b></p>	 	SOIE IVOIRE - <i>IVORY SILK</i> PERLÉ NOIR - <i>BLACK GLASS BEADS</i>	10193600	
	 	SOIE IVOIRE - <i>IVORY SILK</i> PERLÉ ARGENT - <i>SILVER GLASS BEADS</i>	10193601	
	 	SOIE IVOIRE - <i>IVORY SILK</i> PERLÉ OR - <i>GOLD GLASS BEADS</i>	10193602	
	 	SOIE NOIRE - <i>BLACK SILK</i> PERLÉ NOIR - <i>BLACK GLASS BEADS</i>	10193700	
	 	SOIE NOIRE - <i>BLACK SILK</i> PERLÉ ARGENT - <i>SILVER GLASS BEADS</i>	10193701	
	 	SOIE NOIRE - <i>BLACK SILK</i> PERLÉ OR - <i>GOLD GLASS BEADS</i>	10193702	
 <p><b>GM / LS</b></p>	 	SOIE IVOIRE - <i>IVORY SILK</i> PERLÉ NOIR - <i>BLACK GLASS BEADS</i>	10193200	
	 	SOIE IVOIRE - <i>IVORY SILK</i> PERLÉ ARGENT - <i>SILVER GLASS BEADS</i>	10193201	
	 	SOIE IVOIRE - <i>IVORY SILK</i> PERLÉ OR - <i>GOLD GLASS BEADS</i>	10193203	
	 	SOIE NOIRE - <i>BLACK SILK</i> PERLÉ NOIR - <i>BLACK GLASS BEADS</i>	10193300	
	 	SOIE NOIRE - <i>BLACK SILK</i> PERLÉ ARGENT - <i>SILVER GLASS BEADS</i>	10193301	
	 	SOIE NOIRE - <i>BLACK SILK</i> PERLÉ OR - <i>GOLD GLASS BEADS</i>	10193302	

2011 - LADY TINA GREEN & PIETRO MINGARELLI POUR LALIQUE

# COUSSINS PERLÉS - *BEADED CUSHIONS*

MASQUE DE FEMME  
1 BANDE LARGE / 1 LARGE BAND



FINITION / FINISHING	REFERENCE	EAN CODE
<b>PM, 1 BANDE LARGE</b> <b>300 x 450 mm</b> <i>SS, 1 LARGE BAND</i> <i>11.81" x 17.71"</i>	SOIE IVOIRE - <i>IVORY SILK</i> PERLÉ NOIR - <i>BLACK GLASS BEADS</i>	10196000  7 640111 496762
	SOIE NOIRE - <i>BLACK SILK</i> PERLÉ NOIR - <i>BLACK GLASS BEADS</i>	10196100  7 640111 496779
<b>MM, 1 BANDE LARGE</b> <b>500 x 500 mm</b> <i>MS, 1 LARGE BAND</i> <i>19.68" x 19.68"</i>	SOIE IVOIRE - <i>IVORY SILK</i> PERLÉ NOIR - <i>BLACK GLASS BEADS</i>	10200500  7 640111 497721
	SOIE NOIRE - <i>BLACK SILK</i> PERLÉ NOIR - <i>BLACK GLASS BEADS</i>	10200600  7 640111 497738
<b>GM, 1 BANDE LARGE</b> <b>600 x 600 mm</b> <i>LS, 1 LARGE BAND</i> <i>23.62" x 23.62"</i>	SOIE IVOIRE - <i>IVORY SILK</i> PERLÉ NOIR - <i>BLACK GLASS BEADS</i>	10200300  7 640111 496786
	SOIE NOIRE - <i>BLACK SILK</i> PERLÉ NOIR - <i>BLACK GLASS BEADS</i>	10200400  7 640111 496793

2011 - LADY TINA GREEN & PIETRO MINGARELLI POUR LALIQUE

# COUSSINS PERLÉS - *BEADED CUSHIONS*

## MASQUE DE FEMME



FINITION / FINISHING	REFERENCE	EAN CODE
<b>PM, 1 BANDE</b> <b>300 x 450 mm</b> <i>SS, 1 BAND</i> <i>11.81" x 17.71"</i>	SOIE IVOIRE - <i>IVORY SILK</i> PERLÉ NOIR - <i>BLACK GLASS BEADS</i> 10200700	 7 640111 497745
	SOIE NOIRE - <i>BLACK SILK</i> PERLÉ NOIR - <i>BLACK GLASS BEADS</i> 10200800	 7 640111 497929
<b>MM, 3 BANDES</b> <b>500 x 500 mm</b> <i>MS, 3 BANDS</i> <i>19.68" x 19.68"</i>	SOIE IVOIRE - <i>IVORY SILK</i> PERLÉ NOIR - <i>BLACK GLASS BEADS</i> 10195600	 7 640111 496748
	SOIE NOIRE - <i>BLACK SILK</i> PERLÉ NOIR - <i>BLACK GLASS BEADS</i> 10195700	 7 640111 497752
<b>GM, 5 BANDES</b> <b>600 x 600 mm</b> <i>LS, 5 BANDS</i> <i>23.62" x 23.62"</i>	SOIE IVOIRE - <i>IVORY SILK</i> PERLÉ NOIR - <i>BLACK GLASS BEADS</i> 10195200	 7 640111 496724
	SOIE NOIRE - <i>BLACK SILK</i> PERLÉ NOIR - <i>BLACK GLASS BEADS</i> 10195300	 7 640111 496731

2011 - LADY TINA GREEN & PIETRO MINGARELLI POUR LALIQUE

# COUSSINS - CUSHIONS

## PANTHÈRE / PANTHER



**BRODÉ, MM / EMBROIDERY, MS**















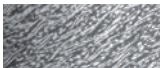



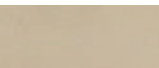

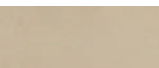

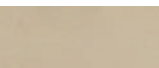









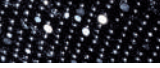







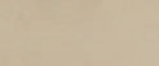
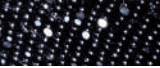

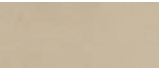

**PERLÉ, PM / GLASS BEADS, SS**

FINITION / FINISHING

REFERENCE

EAN CODE

 <p><b>BRODÉ, MM EMBROIDERY, MS</b></p> <p><b>450 x 300 mm 17.71" x 11.81"</b></p>	 	SOIE IVOIRE - <i>IVORY SILK</i> BRODÉ NOIR - <i>BLACK EMBROIDERY</i>	11602310	
	 	SOIE IVOIRE - <i>IVORY SILK</i> BRODÉ ARGENT - <i>SILVER EMBROIDERY</i>	11602320	
	 	SOIE IVOIRE - <i>IVORY SILK</i> BRODÉ OR - <i>GOLD EMBROIDERY</i>	11602330	
	 	SOIE PLATINE - <i>PLATINUM SILK</i> BRODÉ NOIR - <i>BLACK EMBROIDERY</i>	11602340	
	 	SOIE PLATINE - <i>PLATINUM SILK</i> BRODÉ ARGENT - <i>SILVER EMBROIDERY</i>	11602350	
	 	SOIE PLATINE - <i>PLATINUM SILK</i> BRODÉ OR - <i>GOLD EMBROIDERY</i>	11602360	
	 	SOIE NOIRE - <i>BLACK SILK</i> BRODÉ ARGENT - <i>SILVER EMBROIDERY</i>	11602370	
	 	SOIE NOIRE - <i>BLACK SILK</i> BRODÉ OR - <i>GOLD EMBROIDERY</i>	11602380	
 <p><b>PERLÉ, PM GLASS BEADS, SS</b></p> <p><b>560 x 400 mm 22.04" x 15.74"</b></p>	 	SOIE IVOIRE - <i>IVORY SILK</i> PERLÉ NOIR - <i>BLACK GLASS BEADS</i>	11603110	
	 	SOIE IVOIRE - <i>IVORY SILK</i> PERLÉ ARGENT - <i>SILVER GLASS BEADS</i>	11603120	
	 	SOIE IVOIRE - <i>IVORY SILK</i> PERLÉ OR - <i>GOLD GLASS BEADS</i>	11603130	
	 	SOIE PLATINE - <i>PLATINUM SILK</i> PERLÉ NOIR - <i>BLACK GLASS BEADS</i>	11603140	
	 	SOIE PLATINE - <i>PLATINUM SILK</i> PERLÉ ARGENT - <i>SILVER GLASS BEADS</i>	11603150	
	 	SOIE PLATINE - <i>PLATINUM SILK</i> PERLÉ OR - <i>GOLD GLASS BEADS</i>	11603160	
	 	SOIE NOIRE - <i>BLACK SILK</i> PERLÉ ARGENT - <i>SILVER GLASS BEADS</i>	11603170	
 	SOIE NOIRE - <i>BLACK SILK</i> PERLÉ OR - <i>GOLD GLASS BEADS</i>	11603180		

2011 - LADY TINA GREEN & PIETRO MINGARELLI POUR LALIQUE

# COUVRE-LITS PERLÉS - *BEADED BED-COVERS*

## RAISINS















































Détail du couvre-lit perlé / *Detail view of the beaded bed-cover*



Couvre-lit perlé / *Beaded bed-cover*

### FINITION - *FINISHING*

			REFERENCE	EAN CODE	
			SOIE IVOIRE - <i>IVORY SILK</i> PERLÉ NOIR - <i>BLACK GLASS BEADS</i>	10201303	 7 640111 500407
			SOIE IVOIRE - <i>IVORY SILK</i> PERLÉ ARGENT - <i>SILVER GLASS BEADS</i>	10201304	 7 640111 500391
			SOIE IVOIRE - <i>IVORY SILK</i> PERLÉ OR - <i>GOLD GLASS BEADS</i>	10201305	 7 640111 500384
<b>COUVRE-LIT</b> <b>314 x 270 cm</b> POUR UN MATELAT 180 x 200 cm <b>BED COVER</b> <b>123.62" x 106.29"</b> FOR A MATTRESS SIZE 180 x 200 cm			SOIE NOIRE - <i>BLACK SILK</i> PERLÉ NOIR - <i>BLACK GLASS BEADS</i>	11201303	 7 640111 504405
			SOIE NOIRE - <i>BLACK SILK</i> PERLÉ ARGENT - <i>SILVER GLASS BEADS</i>	11201304	 7 640111 504412
			SOIE NOIRE - <i>BLACK SILK</i> PERLÉ OR - <i>GOLD GLASS BEADS</i>	11201305	 7 640111 504429
			SOIE IVOIRE - <i>IVORY SILK</i> RÉDUCTION, PERLÉ NOIRES - <i>REDUCED, BLACK GLASS BEADS</i>	10201313	 7 640111 505457
			SOIE IVOIRE - <i>IVORY SILK</i> RÉDUCTION, PERLÉ ARGENT - <i>REDUCED, SILVER GLASS BEADS</i>	10201314	 7 640111 505464
			SOIE IVOIRE - <i>IVORY SILK</i> RÉDUCTION, PERLÉ OR - <i>REDUCED, GOLD GLASS BEADS</i>	10201315	 7 640111 505471
<b>COUVRE-LIT</b> <b>334 x 270 cm</b> POUR UN MATELAT 200 x 200 cm <b>BED COVER</b> <b>131.49" x 106.29"</b> FOR A MATTRESS SIZE 200 x 200 cm			SOIE IVOIRE - <i>IVORY SILK</i> PERLÉ NOIR - <i>BLACK GLASS BEADS</i>	10201300	 7 640111 496847
			SOIE IVOIRE - <i>IVORY SILK</i> PERLÉ ARGENT - <i>SILVER GLASS BEADS</i>	10201301	 7 640111 500421
			SOIE IVOIRE - <i>IVORY SILK</i> PERLÉ OR - <i>GOLD GLASS BEADS</i>	10201302	 7 640111 500414
			SOIE NOIRE - <i>BLACK SILK</i> PERLÉ NOIR - <i>BLACK GLASS BEADS</i>	11201300	 7 640111 504375
			SOIE NOIRE - <i>BLACK SILK</i> PERLÉ ARGENT - <i>SILVER GLASS BEADS</i>	11201301	 7 640111 504382
			SOIE NOIRE - <i>BLACK SILK</i> PERLÉ OR - <i>GOLD GLASS BEADS</i>	11201302	 7 640111 504399

### 2011 - LADY TINA GREEN & PIETRO MINGARELLI POUR LALIQUE

# DRAPS BRODÉS - EMBROIDERED TOP FLAT SHEETS

RAISINS



FINITION / FINISHING	REFERENCE	EAN CODE
<b>DRAP BRODÉ</b> <b>260 x 285 cm</b> POUR UN MATELAT 180 x 200 cm <b>EMBROIDERED</b> <b>TOP FLAT SHEET</b> <b>102.36" x 112.20"</b> FOR A MATTRESS SIZE 180 x 200 cm	  COTON IVOIRE - <i>IVORY COTTON</i> BRODÉ NOIR - <i>BLACK EMBROIDERY</i>	11400831  7 640111 497943
	  COTON IVOIRE - <i>IVORY COTTON</i> BRODÉ IVOIRE - <i>IVORY EMBROIDERY</i>	11500800  7 640111 500285
	  COTON IVOIRE - <i>IVORY COTTON</i> BRODÉ ARGENT - <i>SILVER EMBROIDERY</i>	11500806  7 640111 499978
	  COTON IVOIRE - <i>IVORY COTTON</i> BRODÉ OR - <i>GOLD EMBROIDERY</i>	11500812  7 640111 500032
<b>DRAP BRODÉ</b> <b>280 x 300 cm</b> POUR UN MATELAT 200 x 200 cm <b>EMBROIDERED</b> <b>TOP FLAT SHEET</b> <b>110.23" x 118.11"</b> FOR A MATTRESS SIZE 200 x 200 cm	  COTON IVOIRE - <i>IVORY COTTON</i> BRODÉ NOIR - <i>BLACK EMBROIDERY</i>	11400832  7 640111 500292
	  COTON IVOIRE - <i>IVORY COTTON</i> BRODÉ IVOIRE - <i>IVORY EMBROIDERY</i>	11500801  7 640111 500278
	  COTON IVOIRE - <i>IVORY COTTON</i> BRODÉ ARGENT - <i>SILVER EMBROIDERY</i>	11500807  7 640111 499985
	  COTON IVOIRE - <i>IVORY COTTON</i> BRODÉ OR - <i>GOLD EMBROIDERY</i>	11500813  7 640111 500049

2011 - LADY TINA GREEN & PIETRO MINGARELLI POUR LALIQUE

# DRAPS HOUSSE - PLAIN FLAT BOTTOM SHEETS

FINITION / FINISHING	REFERENCE	EAN CODE
<b>270 x 300 cm</b> POUR UN MATELAT 160-180 x 200 cm <b>106.30" x 118.11"</b> FOR A MATTRESS SIZE 160-180 x 200 cm	 COTON IVOIRE <i>IVORY COTTON</i>	11400852  7 640111 505488
<b>300 x 300 cm</b> POUR UN MATELAT 180-200 x 200 cm <b>118.11" x 118.11"</b> FOR A MATTRESS SIZE 180-200 x 200 cm	 COTON IVOIRE <i>IVORY COTTON</i>	11400851  7 640111 496946

2011 - LADY TINA GREEN & PIETRO MINGARELLI POUR LALIQUE



# HOUSES DE COUETTE BRODÉES - EMBROIDERED DUVET COVERS



















## RAISINS



### FINITION / FINISHING

### REFERENCE

### EAN CODE

<b>HOUSSE DE COUETTE BRODÉE</b> <b>260 x 220 cm</b> POUR UN MATELAT 180 x 200 cm <b>EMBROIDERED DUVET COVER</b> <b>102.36" x 86.61"</b> FOR A MATTRESS SIZE 180 x 200 cm			COTON IVOIRE - <i>IVORY COTTON</i> BRODÉ NOIR - <i>BLACK EMBROIDERY</i>	11400810	
			COTON IVOIRE - <i>IVORY COTTON</i> BRODÉ IVOIRE - <i>IVORY EMBROIDERY</i>	11500804	
			COTON IVOIRE - <i>IVORY COTTON</i> BRODÉ ARGENT - <i>SILVER EMBROIDERY</i>	11500810	
			COTON IVOIRE - <i>IVORY COTTON</i> BRODÉ OR - <i>GOLD EMBROIDERY</i>	11500816	
<b>HOUSSE DE COUETTE BRODÉ</b> <b>280 x 235 cm</b> POUR UN MATELAT 200 x 200 cm <b>EMBROIDERED DUVET COVER</b> <b>110.23" x 92.51"</b> FOR A MATTRESS SIZE 200 x 200 cm			COTON IVOIRE - <i>IVORY COTTON</i> BRODÉ NOIR - <i>BLACK EMBROIDERY</i>	11400811	
			COTON IVOIRE - <i>IVORY COTTON</i> BRODÉ IVOIRE - <i>IVORY EMBROIDERY</i>	11500805	
			COTON IVOIRE - <i>IVORY COTTON</i> BRODÉ ARGENT - <i>SILVER EMBROIDERY</i>	11500811	
			COTON IVOIRE - <i>IVORY COTTON</i> BRODÉ OR - <i>GOLD EMBROIDERY</i>	11500817	

2011 - LADY TINA GREEN & PIETRO MINGARELLI POUR LALIQUE



### FINITION / FINISHING

### REFERENCE

### EAN CODE

<b>50 x 90 cm</b> <i>19.68" x 35.43"</i>			COTON IVOIRE - <i>IVORY COTTON</i> BRODÉ NOIR - <i>BLACK EMBROIDERY</i>	11400841	
			COTON IVOIRE - <i>IVORY COTTON</i> BRODÉ IVOIRE - <i>IVORY EMBROIDERY</i>	11500803	
			COTON IVOIRE - <i>IVORY COTTON</i> BRODÉ ARGENT - <i>SILVER EMBROIDERY</i>	11500809	
			COTON IVOIRE - <i>IVORY COTTON</i> BRODÉ OR - <i>GOLD EMBROIDERY</i>	11500815	

**2011 - LADY TINA GREEN & PIETRO MINGARELLI POUR LALIQUE**

Les taies sont vendues par deux. / *The pillow cases are sold per two.*

# TAIES D'OREILLER BRODÉES - *EMBROIDERED PILLOW CASES*

RAISINS



FINITION / FINISHING

REFERENCE

EAN CODE

<b>50 x 90 cm</b> <i>19.68" x 35.43"</i>			COTON IVOIRE - <i>IVORY COTTON</i> BRODÉ NOIR - <i>BLACK EMBROIDERY</i>	11400821	 7 640111 496960
			COTON IVOIRE - <i>IVORY COTTON</i> BRODÉ IVOIRE - <i>IVORY EMBROIDERY</i>	11500802	 7 640111 500261
			COTON IVOIRE - <i>IVORY COTTON</i> BRODÉ ARGENT - <i>SILVER EMBROIDERY</i>	11500808	 7 640111 499992
			COTON IVOIRE - <i>IVORY COTTON</i> BRODÉ OR - <i>GOLD EMBROIDERY</i>	11500814	 7 640111 500056

**2011 - LADY TINA GREEN & PIETRO MINGARELLI POUR LALIQUE**

**Les taies sont vendues par deux. / The pillow cases are sold per two.**

# CARRÉS BRODÉS - EMBROIDERED SQUARE TOWELS (FACE CLOTH)

LALIQUE



Coton ivoire - brodé noir  
Ivory cotton - black embroidery



Coton ivoire - brodé ivoire  
Ivory cotton - ivory embroidery



Coton ivoire - brodé argent  
Ivory cotton - silver embroidery



Coton ivoire - brodé or  
Ivory cotton - gold embroidery

## FINITION / FINISHING

## REFERENCE

## EAN CODE

<b>CARRÉS BRODÉS</b> <b>33 x 33 cm</b> <b>100% coton, 1100g</b> <b>EMBROIDERED</b> <b>SQUARE TOWELS</b> <b>12.99" x 12.99"</b> <b>100% cotton, 1100g</b>			COTON IVOIRE - <i>IVORY COTTON</i> BRODÉ NOIR - <i>BLACK EMBROIDERY</i>	11400110	 7 640111 497011
			COTON IVOIRE - <i>IVORY COTTON</i> BRODÉ IVOIRE - <i>IVORY EMBROIDERY</i>	11400120	 7 640111 497028
			COTON IVOIRE - <i>IVORY COTTON</i> BRODÉ ARGENT - <i>SILVER EMBROIDERY</i>	11400130	 7 640111 497035
			COTON IVOIRE - <i>IVORY COTTON</i> BRODÉ OR - <i>GOLD EMBROIDERY</i>	11400140	 7 640111 497042

2011 - LADY TINA GREEN & PIETRO MINGARELLI POUR LALIQUE

# LINGE DE TOILETTE - *BATH LINEN*

## RAISINS

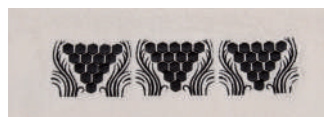

Coton ivoire - brodé noir  
Ivory cotton - black embroidery

















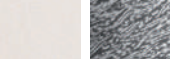



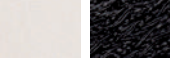

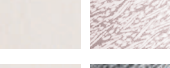







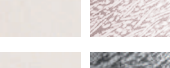

Coton ivoire - brodé ivoire  
Ivory cotton - ivory embroidery

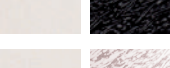

Coton ivoire - brodé argent  
Ivory cotton - silver embroidery



Coton ivoire - brodé or  
Ivory cotton - gold embroidery

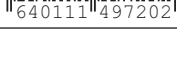















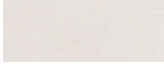

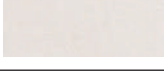





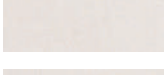

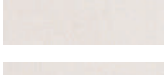

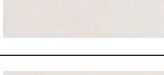

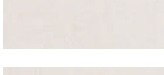

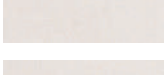
FINITION / FINISHING	REFERENCE	EAN CODE
<b>SERVIETTES INVITÉ BRODÉES</b> <b>40 x 60 cm</b> <b>100% coton, 1100g</b> <b>EMBROIDERED</b> <b>GUEST TOWELS</b> <b>15.74" x 23.62"</b> <b>100% cotton, 1100g</b>	 COTON IVOIRE - <i>IVORY COTTON</i> BRODÉ NOIR - <i>BLACK EMBROIDERY</i>	11400210  7 640111 497059
	 COTON IVOIRE - <i>IVORY COTTON</i> BRODÉ IVOIRE - <i>IVORY EMBROIDERY</i>	11400220  7 640111 497066
	 COTON IVOIRE - <i>IVORY COTTON</i> BRODÉ ARGENT - <i>SILVER EMBROIDERY</i>	11400230  7 640111 497073
	 COTON IVOIRE - <i>IVORY COTTON</i> BRODÉ OR - <i>GOLD EMBROIDERY</i>	11400240  7 640111 497080
<b>SERVIETTES POUR LES MAINS BRODÉES</b> <b>50 x 100 cm</b> <b>100% coton, 1100g</b> <b>EMBROIDERED</b> <b>HANDS TOWELS</b> <b>19.68" x 39.37"</b> <b>100% cotton, 1100g</b>	 COTON IVOIRE - <i>IVORY COTTON</i> BRODÉ NOIR - <i>BLACK EMBROIDERY</i>	11400310  7 640111 497097
	 COTON IVOIRE - <i>IVORY COTTON</i> BRODÉ IVOIRE - <i>IVORY EMBROIDERY</i>	11400320  7 640111 497950
	 COTON IVOIRE - <i>IVORY COTTON</i> BRODÉ ARGENT - <i>SILVER EMBROIDERY</i>	11400330  7 640111 497110
	 COTON IVOIRE - <i>IVORY COTTON</i> BRODÉ OR - <i>GOLD EMBROIDERY</i>	11400340  7 640111 497967
<b>SERVIETTES DE BAIN BRODÉES</b> <b>70 x 140 cm</b> <b>100% coton, 1100g</b> <b>EMBROIDERED</b> <b>BATH TOWELS</b> <b>27.55" x 55.11"</b> <b>100% cotton, 1100g</b>	 COTON IVOIRE - <i>IVORY COTTON</i> BRODÉ NOIR - <i>BLACK EMBROIDERY</i>	11400410  7 640111 497134
	 COTON IVOIRE - <i>IVORY COTTON</i> BRODÉ IVOIRE - <i>IVORY EMBROIDERY</i>	11400420  7 640111 497141
	 COTON IVOIRE - <i>IVORY COTTON</i> BRODÉ ARGENT - <i>SILVER EMBROIDERY</i>	11400430  7 640111 497158
	 COTON IVOIRE - <i>IVORY COTTON</i> BRODÉ OR - <i>GOLD EMBROIDERY</i>	11400440  7 640111 497974
<b>DRAPS DE BAIN BRODÉS</b> <b>90 x 160 cm</b> <b>100% coton, 1100g</b> <b>EMBROIDERED</b> <b>BATH SHEETS</b> <b>35.43" x 62.99"</b> <b>100% cotton, 1100g</b>	 COTON IVOIRE - <i>IVORY COTTON</i> BRODÉ NOIR - <i>BLACK EMBROIDERY</i>	11400510  7 640111 497172
	 COTON IVOIRE - <i>IVORY COTTON</i> BRODÉ IVOIRE - <i>IVORY EMBROIDERY</i>	11400520  7 640111 497189
	 COTON IVOIRE - <i>IVORY COTTON</i> BRODÉ ARGENT - <i>SILVER EMBROIDERY</i>	11400530  7 640111 497196
	 COTON IVOIRE - <i>IVORY COTTON</i> BRODÉ OR - <i>GOLD EMBROIDERY</i>	11400540  7 640111 497202

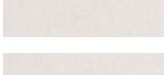
2011 - LADY TINA GREEN & PIETRO MINGARELLI POUR LALIQUE

# PEIGNOIRS BRODÉS - EMBROIDERED BATHROBES

## HIRONDELLES



FINITION / FINISHING		REFERENCE	EAN CODE		
<b>TAILLE S</b> 100% coton, 1100g SIZE S 100% cotton, 1100g			COTON IVOIRE - IVORY COTTON BRODÉ NOIR - BLACK EMBROIDERY	11400710	 7 640111 497257
			COTON IVOIRE - IVORY COTTON BRODÉ IVOIRE - IVORY EMBROIDERY	11400720	 7 640111 497981
			COTON IVOIRE - IVORY COTTON BRODÉ ARGENT - SILVER EMBROIDERY	11400730	 7 640111 497318
			COTON IVOIRE - IVORY COTTON BRODÉ OR - GOLD EMBROIDERY	11400740	 7 640111 497349
<b>TAILLE M</b> 100% coton, 1100g SIZE M 100% cotton, 1100g			COTON IVOIRE - IVORY COTTON BRODÉ NOIR - BLACK EMBROIDERY	11400711	 7 640111 497264
			COTON IVOIRE - IVORY COTTON BRODÉ IVOIRE - IVORY EMBROIDERY	11400721	 7 640111 497295
			COTON IVOIRE - IVORY COTTON BRODÉ ARGENT - SILVER EMBROIDERY	11400731	 7 640111 497325
			COTON IVOIRE - IVORY COTTON BRODÉ OR - GOLD EMBROIDERY	11400741	 7 640111 497356
<b>TAILLE L</b> 100% coton, 1100g SIZE L 100% cotton, 1100g			COTON IVOIRE - IVORY COTTON BRODÉ NOIR - BLACK EMBROIDERY	11400712	 7 640111 497271
			COTON IVOIRE - IVORY COTTON BRODÉ IVOIRE - IVORY EMBROIDERY	11400722	 7 640111 497301
			COTON IVOIRE - IVORY COTTON BRODÉ ARGENT - SILVER EMBROIDERY	11400732	 7 640111 497332
			COTON IVOIRE - IVORY COTTON BRODÉ OR - GOLD EMBROIDERY	11400742	 7 640111 497363
<b>TAILLE XL</b> 100% coton, 1100g SIZE XL 100% cotton, 1100g			COTON IVOIRE - IVORY COTTON BRODÉ IVOIRE - IVORY EMBROIDERY	11400723	 7 640111 506805

2011 - LADY TINA GREEN & PIETRO MINGARELLI POUR LALIQUE

# TAPIS DE BAIN BRODÉS - EMBROIDERED BATH MATS

## HIRONDELLES



Coton ivoire - brodé noir  
Ivory cotton - black embroidery



Coton ivoire - brodé ivoire  
Ivory cotton - ivory embroidery



Coton ivoire - brodé argent  
Ivory cotton - silver embroidery



Coton ivoire - brodé or  
Ivory cotton - gold embroidery

### FINITION / FINISHING

### REFERENCE

### EAN CODE

<b>TAPIS DE BAIN BRODÉS</b> <b>60 X 100 cm</b> <b>100% coton, 1100g</b> <b>EMBROIDERED</b> <b>BATH MATS</b> <b>23.62" x 29.37"</b> <b>100% cotton, 1100g</b>			COTON IVOIRE - <i>IVORY COTTON</i> BRODÉ NOIR - <i>BLACK EMBROIDERY</i>	11400610	 7 640111 497219
			COTON IVOIRE - <i>IVORY COTTON</i> BRODÉ IVOIRE - <i>IVORY EMBROIDERY</i>	11400620	 7 640111 497226
			COTON IVOIRE - <i>IVORY COTTON</i> BRODÉ ARGENT - <i>SILVER EMBROIDERY</i>	11400630	 7 640111 497233
			COTON IVOIRE - <i>IVORY COTTON</i> BRODÉ OR - <i>GOLD EMBROIDERY</i>	11400640	 7 640111 497240

2011 - LADY TINA GREEN & PIETRO MINGARELLI POUR LALIQUE

# SERVIETTES ET SETS DE TABLE - *NAPKINS AND PLACEMATS*

1 HIRONDELLE

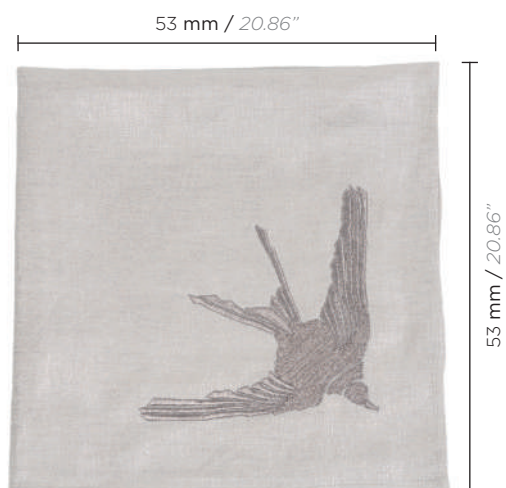

**SERVIETTE DE TABLE CARRÉE**  
*SQUARE NAPKINS*



**SET DE TABLE RECTANGULAIRE**  
*RECTANGULAR PLACEMAT*

FINITION / FINISHING		REFERENCE	EAN CODE
<b>SERVIETTE DE TABLE CARRÉE / SQUARE NAPKINS</b> 	<b>À L'UNITÉ</b> <i>PER UNIT</i>	LIN MÉTALISÉ - <i>METALLIC LINEN</i> BRODÉ ÉTAÏN - <i>PEWTER EMBROIDERY</i> 11601310	 7 640111 504641
	<b>SET DE 4</b> <i>SET OF 4</i>	LIN MÉTALISÉ - <i>METALLIC LINEN</i> BRODÉ ÉTAÏN - <i>PEWTER EMBROIDERY</i> 11601340	 7 640111 504658
<b>SET DE TABLE RECTANGULAIRE / RECTANGULAR PLACEMAT</b> 	<b>À L'UNITÉ</b> <i>PER UNIT</i>	LIN MÉTALISÉ - <i>METALLIC LINEN</i> BRODÉ ÉTAÏN - <i>PEWTER EMBROIDERY</i> 11600110	 7 640111 504528
	<b>SET DE 4</b> <i>SET OF 4</i>	LIN MÉTALISÉ - <i>METALLIC LINEN</i> BRODÉ ÉTAÏN - <i>PEWTER EMBROIDERY</i> 11600140	 7 640111 504535



# SERVIETTES ET SETS DE TABLE - *NAPKINS AND PLACEMATS*

## 4 HIRONDELLES

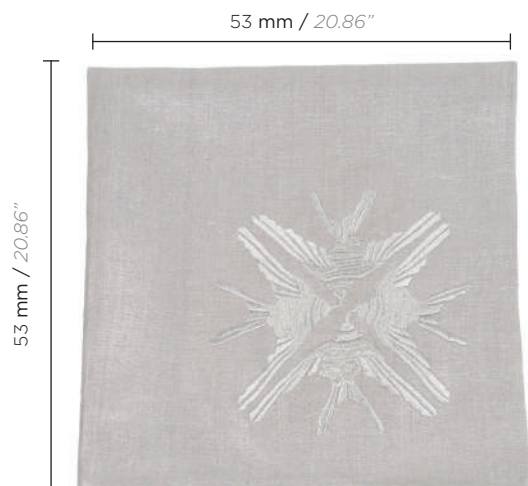

**SERVIETTE DE TABLE CARRÉE**  
**SQUARE NAPKINS**



**SET DE TABLE CIRCULAIRE**  
**CIRCULAR PLACEMAT**

FINITION / FINISHING

REFERENCE

EAN CODE

**SERVIETTE DE TABLE CARRÉE / SQUARE NAPKINS**

**À L'UNITÉ PER UNIT**

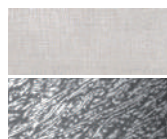

LIN MÉTALISÉ - METALLIC LINEN  
BRODÉ ARGENT - SILVER EMBROIDERY

11601210



7 640111 504627

**SET DE 4 SET OF 4**

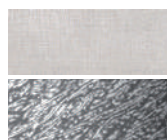

LIN MÉTALISÉ - METALLIC LINEN  
BRODÉ ARGENT - SILVER EMBROIDERY

11601240



7 640111 504634

**SET DE TABLE CIRCULAIRE / CIRCULAR PLACEMAT**

**À L'UNITÉ PER UNIT**

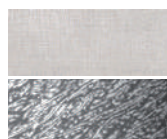

LIN MÉTALISÉ - METALLIC LINEN  
BRODÉ ARGENT - SILVER EMBROIDERY

11600410



7 640111 504580

**SET DE 4 SET OF 4**

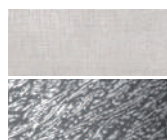

LIN MÉTALISÉ - METALLIC LINEN  
BRODÉ ARGENT - SILVER EMBROIDERY

11600440



7 640111 504597

2011 - LADY TINA GREEN & PIETRO MINGARELLI POUR LALIQUE

# SERVIETTES ET SETS DE TABLE - *NAPKINS AND PLACEMATS*

2 POISSONS / *KOI CIRCLE*

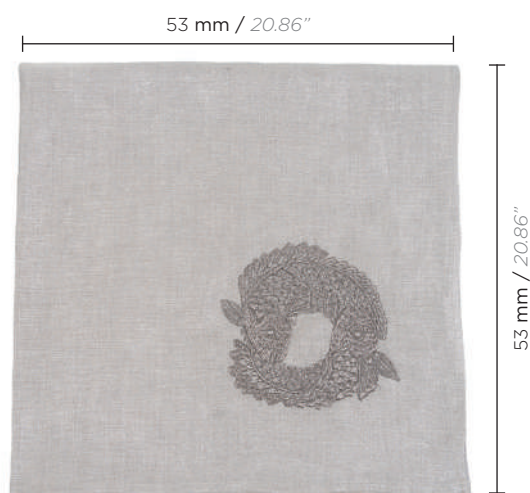

**SERVIETTE DE TABLE CARRÉE**  
*SQUARE NAPKINS*



**SET DE TABLE CIRCULAIRE**  
*CIRCULAR PLACEMAT*

FINITION / *FINISHING*

REFERENCE

EAN CODE

**SERVIETTE DE TABLE CARRÉE / SQUARE NAPKINS**



**À L'UNITÉ**  
*PER UNIT*



LIN MÉTALISÉ - *METALLIC LINEN*  
BRODÉ ÉTAIN - *PEWTER EMBROIDERY*

11601110



**SET DE 4**  
*SET OF 4*



LIN MÉTALISÉ - *METALLIC LINEN*  
BRODÉ ÉTAIN - *PEWTER EMBROIDERY*

11601140



**SET DE TABLE CIRCULAIRE / CIRCULAR PLACEMAT**



**À L'UNITÉ**  
*PER UNIT*



LIN MÉTALISÉ - *METALLIC LINEN*  
BRODÉ ÉTAIN - *PEWTER EMBROIDERY*

11600310



**SET DE 4**  
*SET OF 4*



LIN MÉTALISÉ - *METALLIC LINEN*  
BRODÉ ÉTAIN - *PEWTER EMBROIDERY*

11600340



# SERVIETTES ET SETS DE TABLE - *NAPKINS AND PLACEMATS*

## RINCEAUX / SCALLOP

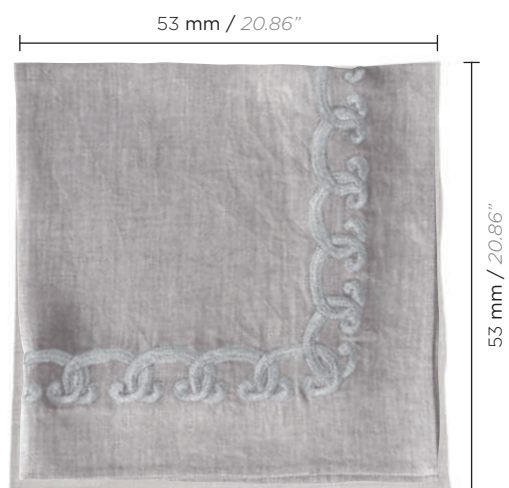

**SERVIETTE DE TABLE CARRÉE**  
*SQUARE NAPKINS*

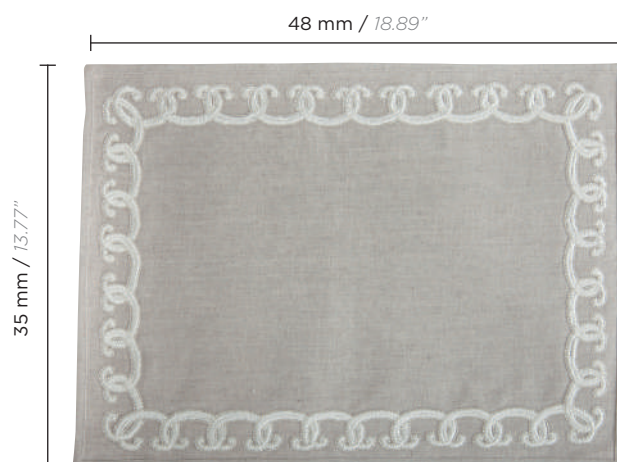

**SET DE TABLE RECTANGULAIRE**  
*RECTANGULAR PLACEMAT*

### FINITION / FINISHING

### REFERENCE

### EAN CODE

#### SERVIETTE DE TABLE CARRÉE / *SQUARE NAPKINS*



**À L'UNITÉ**  
*PER UNIT*

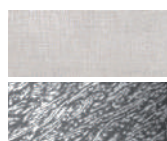

LIN MÉTALISÉ - *METALLIC LINEN*  
BRODÉ ARGENT - *SILVER EMBROIDERY*

11601410



**SET DE 4**  
*SET OF 4*

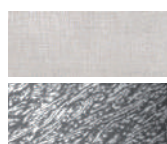

LIN MÉTALISÉ - *METALLIC LINEN*  
BRODÉ ARGENT - *SILVER EMBROIDERY*

11601440



#### SET DE TABLE RECTANGULAIRE / *RECTANGULAR PLACEMAT*



**À L'UNITÉ**  
*PER UNIT*

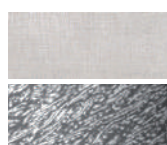

LIN MÉTALISÉ - *METALLIC LINEN*  
BRODÉ ARGENT - *SILVER EMBROIDERY*

11600210



**SET DE 4**  
*SET OF 4*

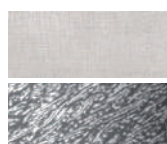

LIN MÉTALISÉ - *METALLIC LINEN*  
BRODÉ ARGENT - *SILVER EMBROIDERY*

11600240



2011 - LADY TINA GREEN & PIETRO MINGARELLI POUR LALIQUE

Photos non contractuelles.  
Les produits ne sont pas représentés à leurs tailles réelles. Édition janvier 2020.

RCS Paris B775 667 736 - SA dont le siège social est situé  
11, rue Royale - 75008 Paris - France  
Capital social de 34.400.000 e

RCS Zurich CHE-203.099.958 dont le siège social est situé  
Grubenstrasse 18 - CH-8045 Zürich - Switzerland  
Capital social de CHF 100,000

Droits réservés

*Non-contractual photos.  
The products are not represented in their actual sizes. January 2020 edition.*

*Trade and companies' register B775 667 736  
11, rue Royale - 75008 Paris - France  
Authorized capital 34.400.000 e*

*Trade and companies' register Zurich CHE-203.099.958  
Grubenstrasse 18 - CH-8045 Zürich - Switzerland  
Capital social de CHF 100,000*

*All rights reserved*

